

Starting Soon: Vapor Intrusion Mitigation Training – Session 1

- ▶ Vapor Intrusion Mitigation Training Online Guidance Document, <https://vim-1.itrcweb.org/>.
- ▶ Download PowerPoint slides
 - ▶ CLU-IN training page at <https://clu-in.org/conf/itrc/VIM-1/>. Under “Download Training Materials.”

Use “Join Audio” option in lower left of Zoom webinar to listen to webinar
Problems joining audio? Please call in manually

Dial In 301 715 8592
Webinar ID: 853 0438 9541#



Advancing
Environmental
Solutions

Vapor Intrusion Mitigation

VIM-1, 2021

Session 1 (of 2)



Sponsored by: Interstate Technology & Regulatory Council (www.itrcweb.org)

Hosted by: US EPA Clean Up Information Network (www.clu-in.org)



ECOS

ERIS
ENVIRONMENTAL RESEARCH
INSTITUTE OF THE STATES

Housekeeping

▶ Recording for On Demand Viewing



▶ Course Information and Materials:

<https://clu-in.org/conf/itrc/vim-1/>



▶ Technical difficulties? Use Q&A Pod

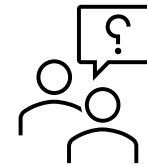

▶ Certificate of Course Completion



ITRC – Shaping the Future of Regulatory Acceptance

- ▶ Host Organization 
- ▶ Network - All 50 states, PR, DC
- ▶ Federal Partners   
DOE DOD EPA
- ▶ ITRC Industry Affiliates Program 
- ▶ Academia
- ▶ Community Stakeholders

- ▶ Disclaimer
 - ▶ <https://vim-1.itrcweb.org/about-itrc/>
- ▶ Partially funded by the US government
 - ▶ ITRC nor US government warranty material
 - ▶ ITRC nor US government endorse specific products
 - ▶ ITRC materials available for your use – see [usage policy](#)



itrcweb.org



facebook.com/
itrcweb



@ITRCWEB



linkedin.com/
company/itrc

Today's Presenters



Kelly Johnson, P.G.
Jacobs
KellyG.Johnson@jacobs.com



David Folkes, P.E.
Geosyntec
dfolkes@geosyntec.com

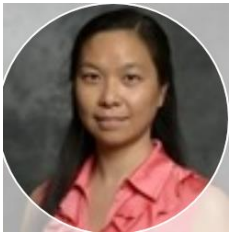

Emma Hong Luo, PhD
Chevron
Emma.hong.luo@chevron.com



Jennifer Borski
Wisconsin Department of Natural Resources
jennifer.borski@wisconsin.gov



Eric Blodgett, P.E.
Barr Engineering
eblodgett@barr.com



Marek Ostrowski, P.E.
Brown & Caldwell
mostrowski@brwncald.com

Today's Training Topics



Source: Geosyntec & GSI Environmental, 2020. Used with permission.

Conceptual Site Models for VI Mitigation

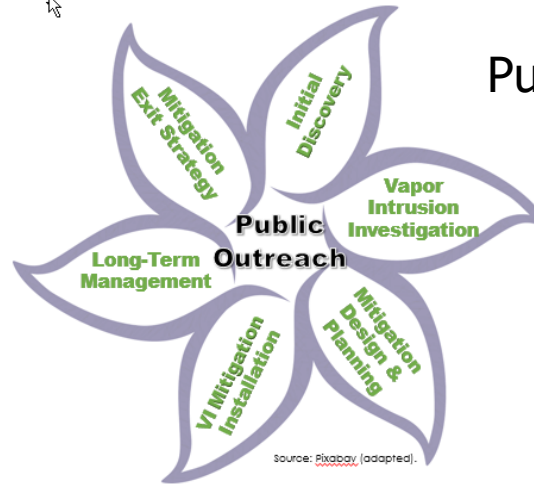

Source: Fixalpay (adapted).

Public Outreach during VI Mitigation

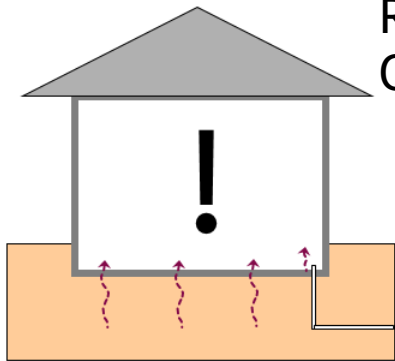

Source: Barr Engineering, 2020. Used with permission.

Rapid Response and Ventilation Outreach Materials

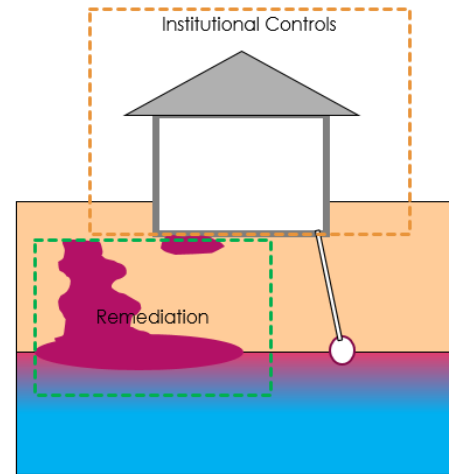

Source: Geosyntec & GSI Environmental, 2020. Used with permission.

Remediation and Institutional Controls as VIM Outreach Materials

What You Should Learn

- ▶ Background on the VIM Training team
- ▶ Overview of available documentation
- ▶ How access the mitigation strategies information
- ▶ Identify the sections that will be discussed in today's session

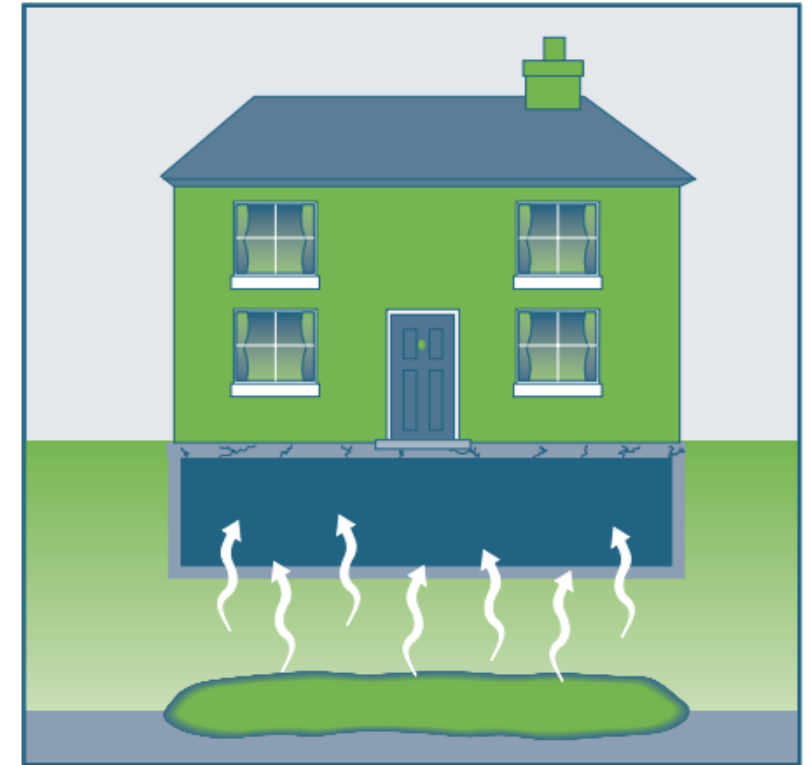

Not Covered in the VIM Training

- ▶ Emergency response actions –
Immediately contact first responders if
 - ▶ Reports of strong petroleum odors
 - ▶ Evidence of combustible, explosive, or oxygen-deficient conditions inside the building
- ▶ Methane mitigation or hazardous substances that have a high explosive potential
- ▶ Radon



Figure from ITRC Petroleum Vapor Intrusion: Fundamentals of Screening, Investigation, and Management (2014).

Emerging Technologies Outreach Materials

Capture technologies and strategies that are not exclusively “mitigation” or “remediation”

- ▶ Aerobic Vapor Migration Barriers (AVMBs) create an aerobic biobarrier for petroleum vapors
- ▶ Placeholder for inclusion of emerging technologies in the future

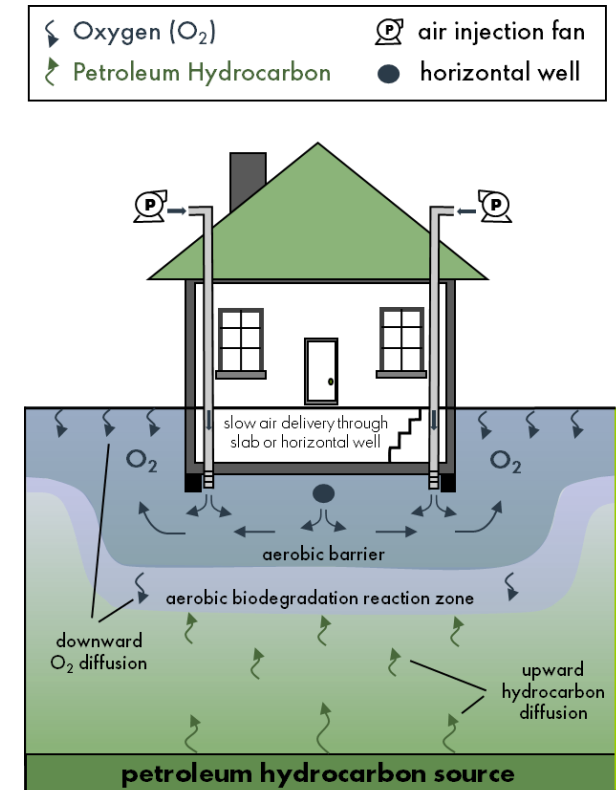
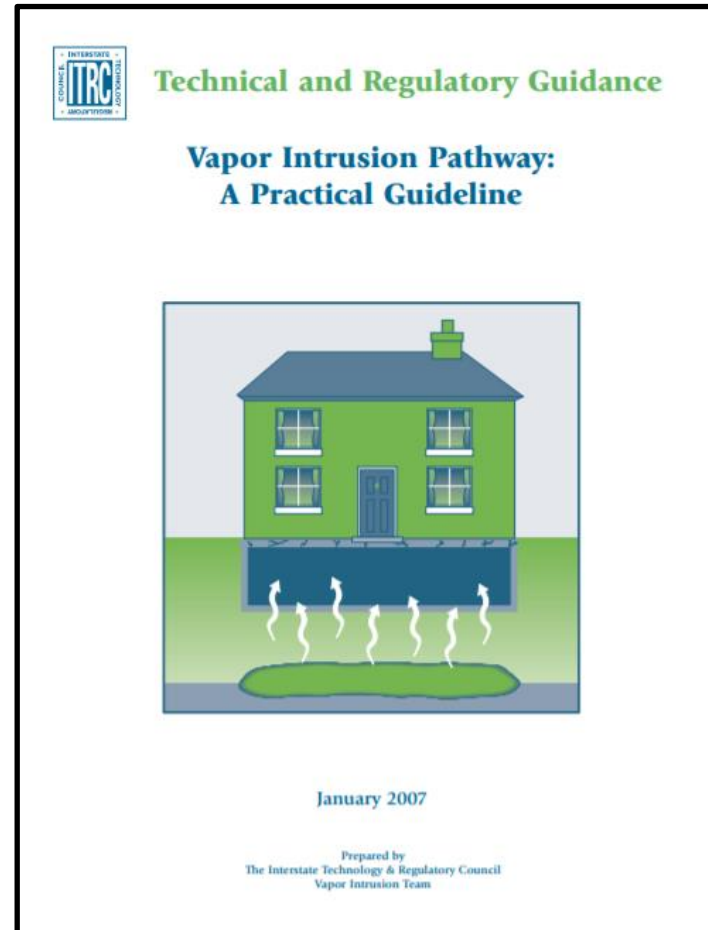

Figure 1 from the AVMB Technology Information Sheet.

Vapor Intrusion Mitigation (VIM) Training Team Background

- ▶ Previous ITRC guidance documents focused on investigative process
- ▶ Multiple requests for “...additional details and training on mitigation”



<https://www.itrcweb.org/Documents/VI-1.pdf>

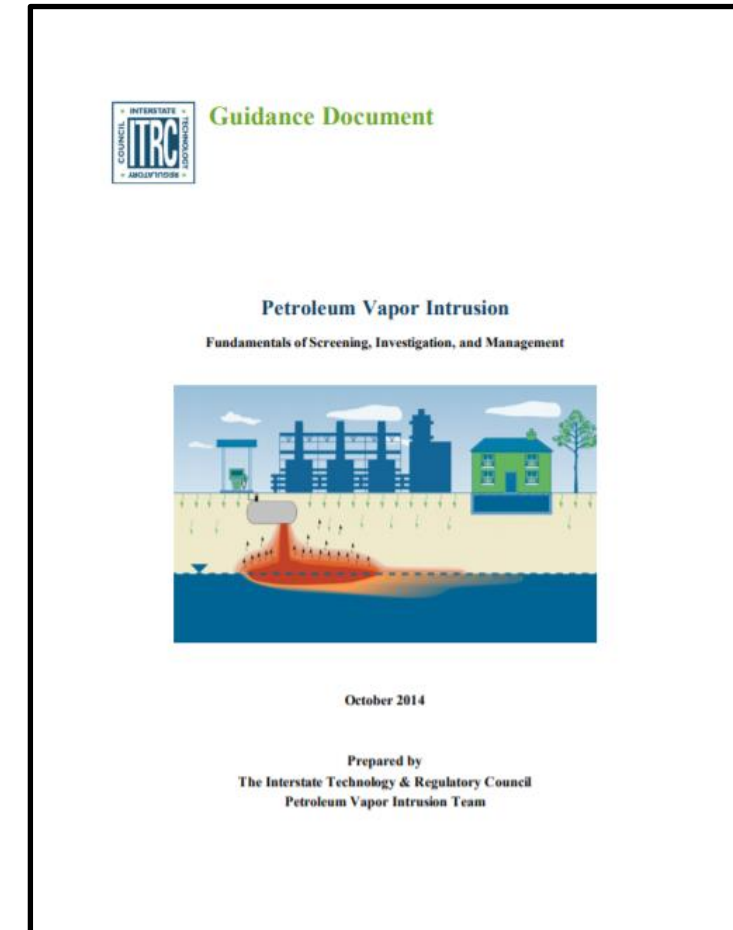

<https://www.itrcweb.org/PetroleumVI-Guidance/>

What is Vapor Intrusion (VI)

- ▶ Contaminants in soil and groundwater can volatilize into soil gas
- ▶ VI occurs when these vapors migrate upward into overlying buildings and contaminate indoor air
- ▶ If present at sufficiently high concentrations:
 - ▶ These vapors may present a threat to the health and safety of building occupants

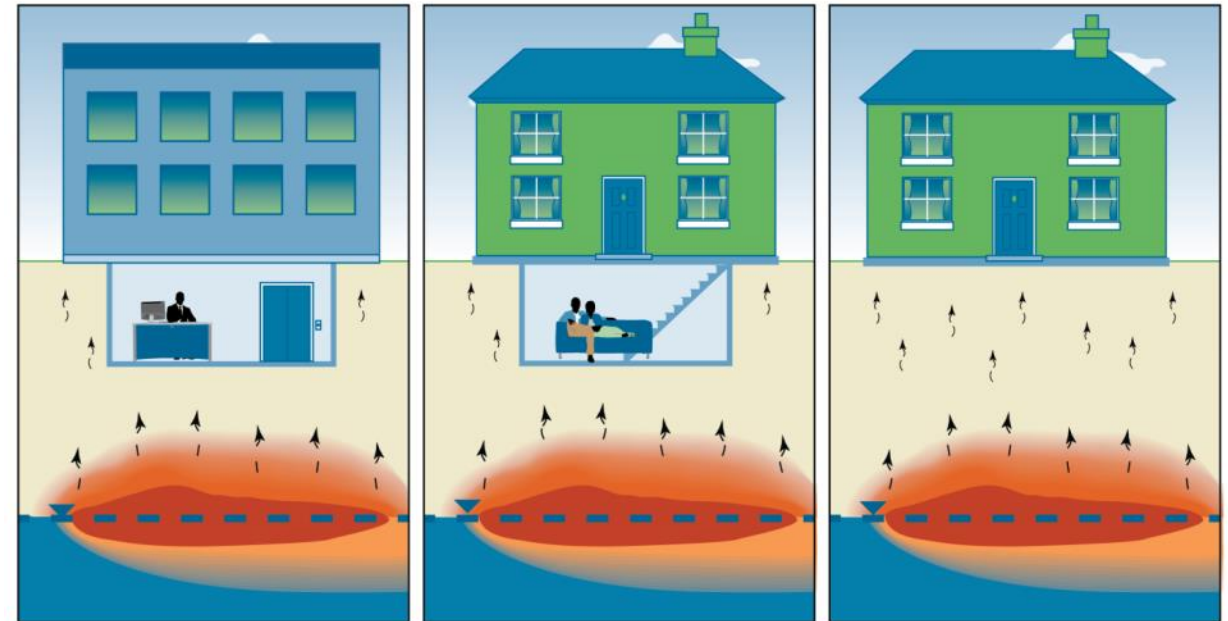

Source: ITRC Petroleum Vapor Intrusion Guidance (PVI-1, 2014)

Different Types of Vapor Intrusion

- ▶ Chlorinated Vapor Intrusion (CVI) which addresses chlorinated compounds
- ▶ Petroleum Vapor Intrusion (PVI) is a subset of VI that deals exclusively with petroleum hydrocarbon (PHC) contaminants



Source: ITRC Vapor Intrusion Pathway: A Practical Guideline (VI-1, 2007)

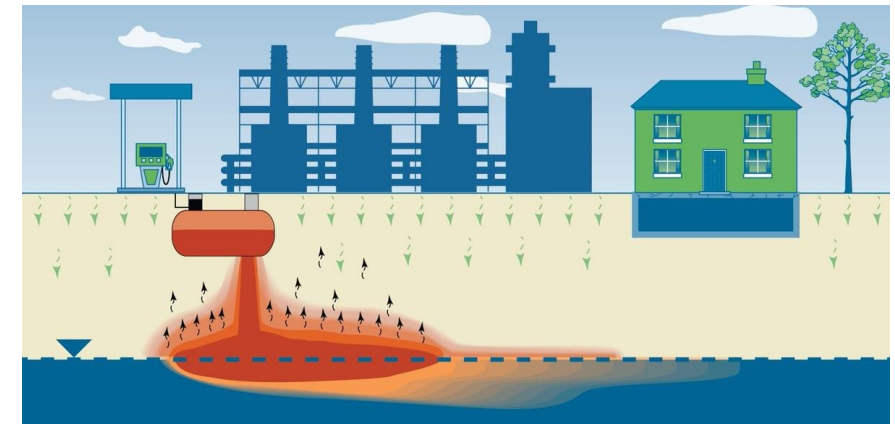

Source: ITRC Petroleum Vapor Intrusion Guidance (PVI-1, 2014)

VI Mitigation (VIM)

- ▶ Implemented to reduce indoor air contaminants due to VI below applicable action or screening levels
- ▶ Accomplished by
 - ▶ Modifying the VI pathway to reduce the mass flux of contaminants entering the building
 - ▶ Reducing indoor air contaminant concentrations by removal or dilution

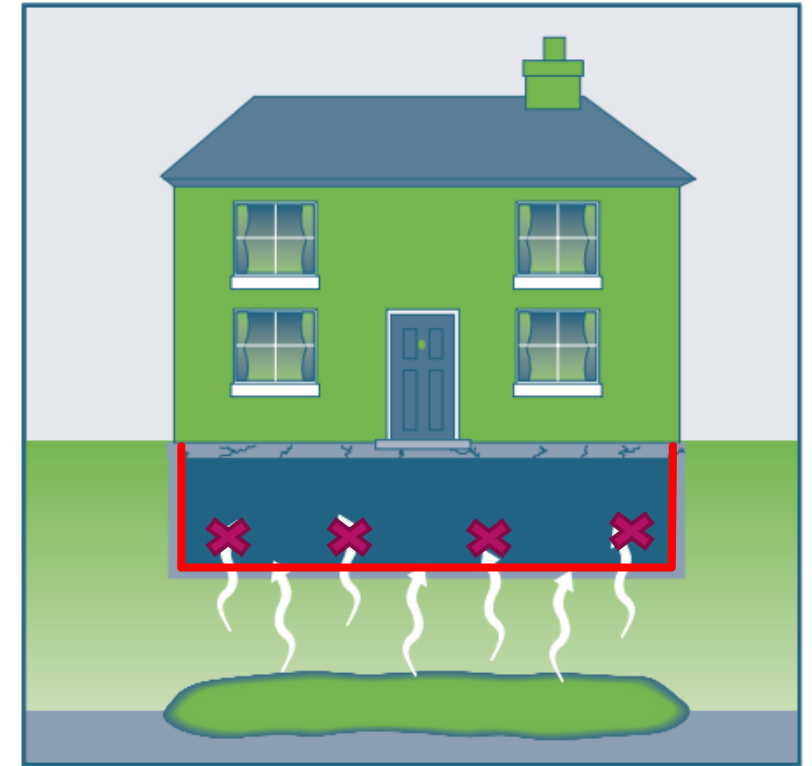

What is VI Mitigation (or Vapor Control)?

- ▶ VOC Vapor control can include
 - ▶ Source remediation
 - ▶ Active or passive mitigation
 - ▶ Rapid response
 - ▶ Institutional controls

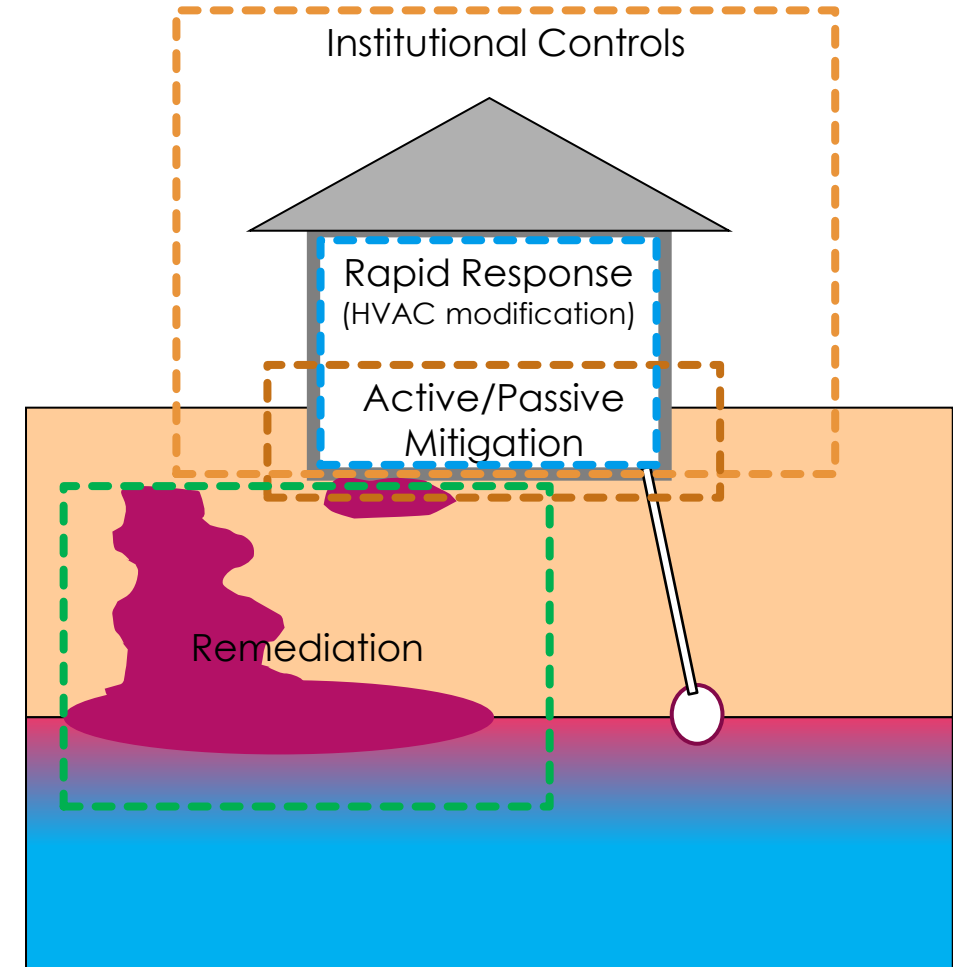

Source: Geosyntec & GSI Environmental, 2020. Used with permission.

Steps in the VIM Process

Pre-System Installation

1. Assessment of Site Conditions
2. Technology Selection
3. Develop and Document System Design



System Installation

4. Pre-construction Meeting
5. Installation
6. Installation Oversight

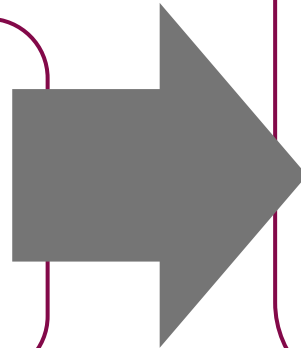

Post-System Installation

7. System Verification
 - a) Inspection
 - b) Verification Sampling
 - c) Confirming Performance QA/QC
8. Documentation
9. Operation, Maintenance, and Monitoring

ITRC VIM Webpage

- ▶ Interactive Directory
- ▶ Fact Sheets
- ▶ Technology Information Sheets
- ▶ Flow Chart for VIM CSM Development (Figure 2-1)
- ▶ Considerations and impacts of various VIM approaches
- ▶ Checklists
- ▶ Additional information

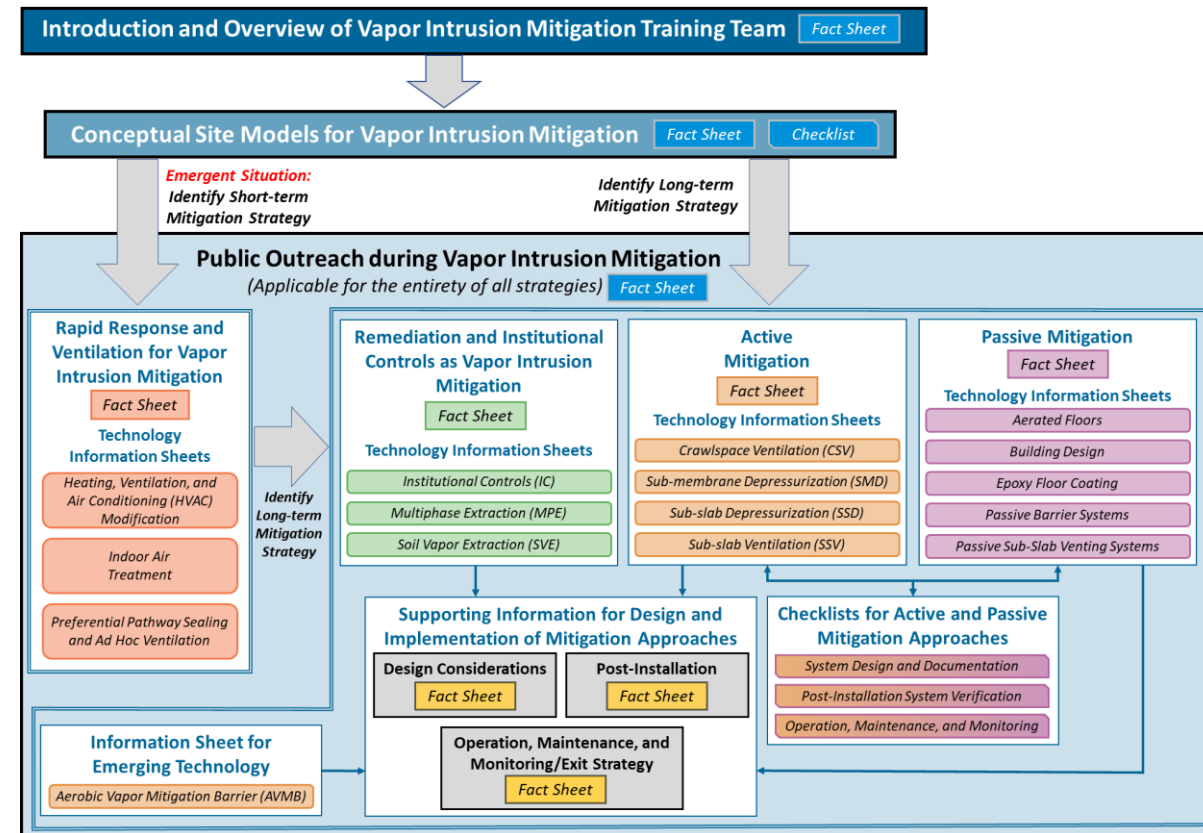

<https://vim-1.itrcweb.org/>

Process Fact Sheet Rating System

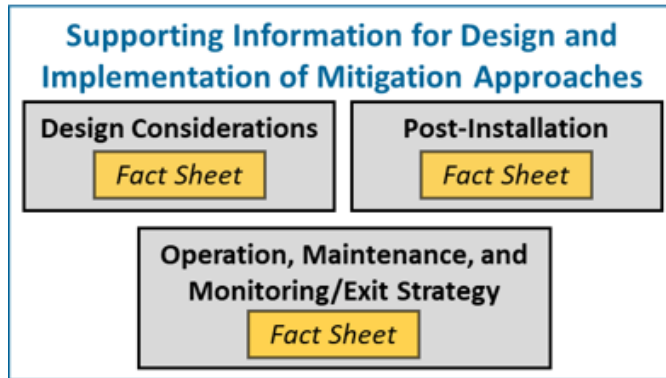

Ratings provided by mitigation "type"

Category →

Principal consideration →

Subject matter →

	Active approaches	Passive approaches	Remediation	Rapid response
Design consideration				
<i>VI CSM considerations</i>				
<i>Vapor source and concentration</i>				
Vapor source and concentration	●	●	●	●
<i>Geology and hydrogeology</i>				
Subgrade soil type	●	◐	●	◐
Depth to groundwater/high water conditions	●	●	●	●

Key | High impact ● | Medium impact ● | Low impact ◐ | Not applicable —

Process Fact Sheet Narrative

Supporting Information for Design and Implementation of Mitigation Approaches

Design Considerations

Fact Sheet

Post-Installation

Fact Sheet

Operation, Maintenance, and Monitoring/Exit Strategy

Fact Sheet

Design consideration	Active approaches	Passive approaches	Remediation	Rapid response
<i>VI CSM considerations</i>				
<i>Vapor source and concentration</i>				
Vapor source and concentration	●	●	●	●
<i>Geology and hydrogeology</i>				
Subgrade soil type	●	◐	●	◐
Depth to groundwater/high water conditions	●	●	●	●

Key | High impact ● | Medium impact ◐ | Low impact ◑ | Not applicable —

Subgrade Soil Type: In most cases, the properties of soils immediately adjacent to the building (e.g., below the slab or next to foundation walls and footings) have the greatest impact on active mitigation technologies that require the movement of air and/or the propagation of vacuum below the slab. Soil type plays a major consideration for active mitigation strategies and makes some remediation technologies difficult to implement. For a more detailed description of methods to test and mathematically model the sub-slab permeability and transmissivity see ([McAlary et al., 2018](#) >). See Section J.2.5 of [Appendix J in the 2014 ITRC PVI document \(ITRC, 2014](#) >) for more information on the consideration of soil type in active mitigation.

Active Mitigation	High Impact: Permeability of the sub-slab fill material and underlying soil controls the pressure field extension (PFE) and air flow rates and, therefore, the degree to which sub-slab depressurization (SSD) and sub-slab ventilation (SSV) contribute to indoor air quality protection. This affects the spacing of suction points and fan size required to induce and maintain the negative pressure field beneath the structure.
Passive Mitigation	Low Impact: Passive mitigation systems typically incorporate a permeable layer beneath barriers and around vent piping in new construction. It may not be feasible to incorporate a permeable layer beneath an existing building. Therefore, passive venting systems function best in soils that are highly permeable when retrofitting an existing building.
Environmental Remediation Technology	High Impact: Remediation technologies require the characterization of soils beyond the subsurface to evaluate the effectiveness of the proposed technology. MPE and SVE are generally not applicable to low-permeability soils.
Rapid Response	Low Impact: Rapid responses typically include ventilation changes, indoor air treatment, or other efforts that are focused inside the building, therefore sub-slab conditions are not relevant.

Checklists

Conceptual Site Models for Vapor Intrusion Mitigation

Fact Sheet

Checklist

Checklists for Active and Passive Mitigation Approaches

System Design and Documentation

Post-Installation System Verification

Operation, Maintenance, and Monitoring

Clickable Check Boxes

Category

Primary prompt

Prompt to record supporting information

Conditional (secondary) prompt

3. BUILDING CONDITIONS AND USE

3.1. Is the building's heating system or heating, ventilating, and air conditioning (HVAC) system operating?

Yes No NA

If yes, provide a summary below and explain in Section 5 if the HVAC system operation could impact the effectiveness of the mitigation system.

Editable Fields

Hours/day of HVAC operation 12

Climate controlled?

Yes No NA

3.1.1. Is the building's heating system or HVAC system on during this OM&M event?

Yes No NA

3.1.2. Is the building's heating system or HVAC system equipped with outside dampers?

Yes No NA

If yes, how many? _____ % opened _____

Coming Up Next...

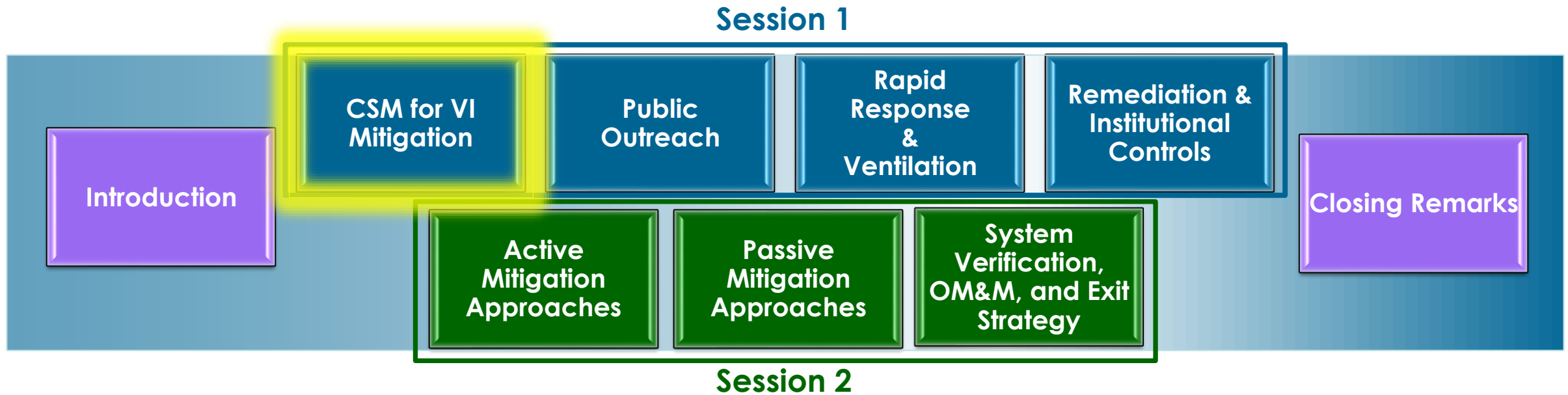



Advancing
Environmental
Solutions

Conceptual Site Models for Vapor Intrusion Mitigation

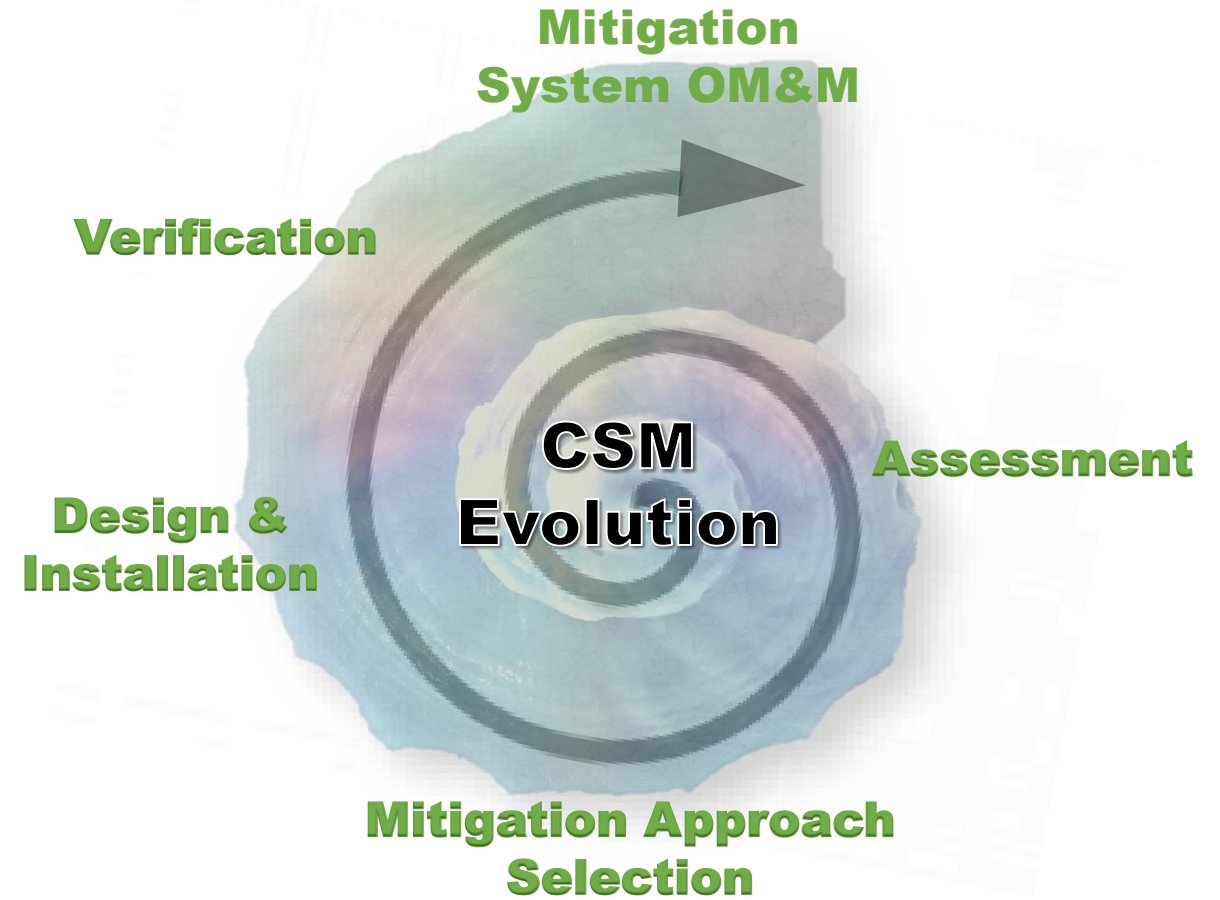

Source: Geosyntec & GSI Environmental, 2020. Used with permission.



ERIS
ENVIRONMENTAL RESEARCH
INSTITUTE OF THE STATES

E C O S

Objectives of Module

- ▶ Understand the importance of a VI “mitigation CSM”
- ▶ Identify data needed to enhance the CSM
- ▶ Use the enhanced CSM to evaluate mitigation options

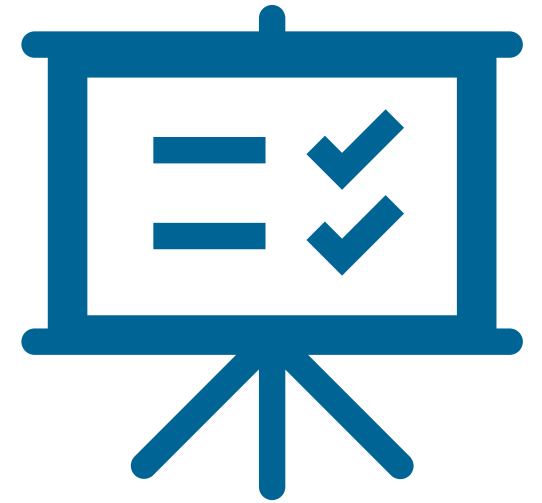

What is a Mitigation CSM?

- ▶ The VI CSM describes the VI pathway
- ▶ Mitigation modifies the VI pathway to reduce potential exposure
- ▶ A "mitigation-grade" CSM has sufficient information to evaluate mitigation alternatives

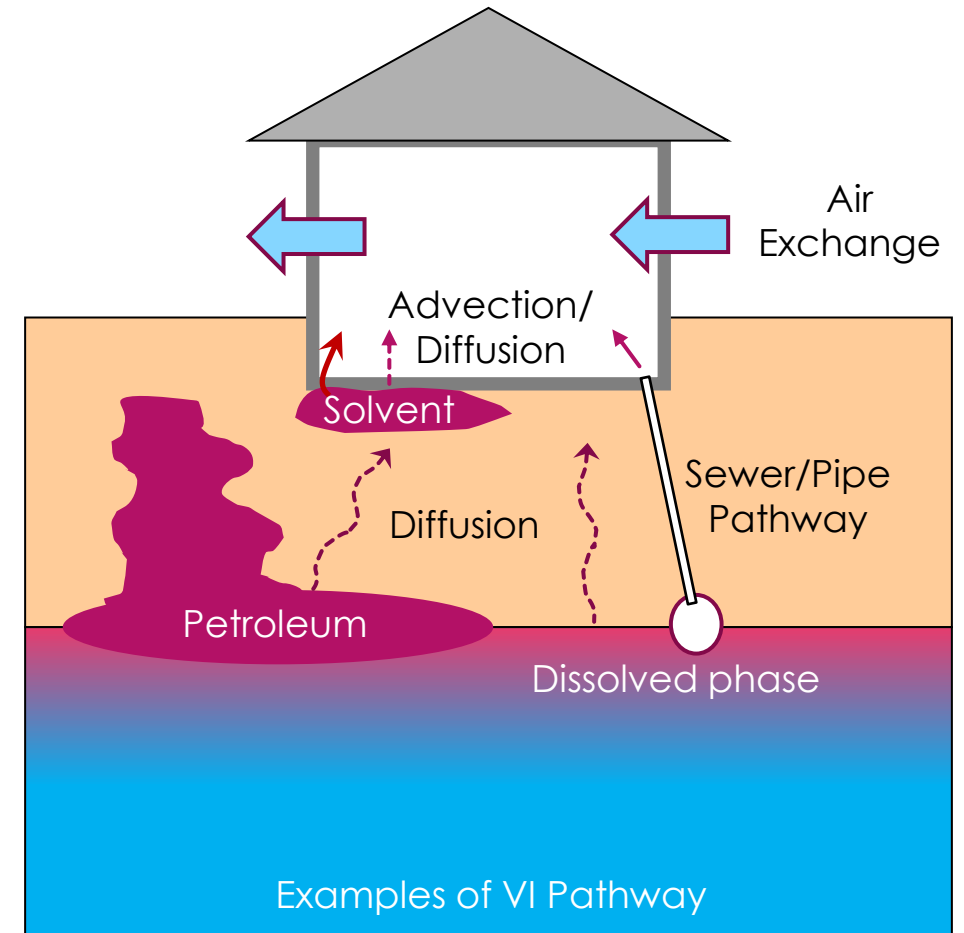

Source: Geosyntec & GSI Environmental, 2020. Used with permission.

How can we modify or control the VI Pathway?

- ▶ VOC Vapor control can include
 - ▶ Source remediation
 - ▶ Active or passive mitigation
 - ▶ Rapid response
 - ▶ Institutional controls

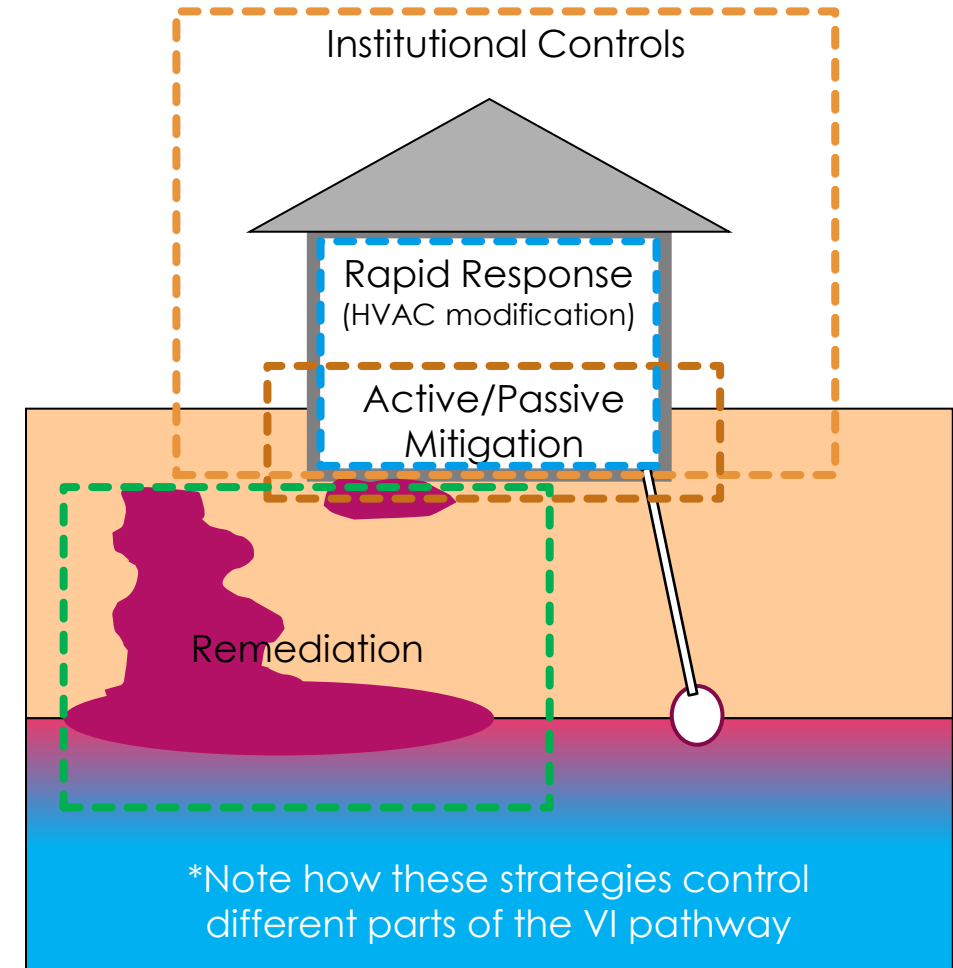

Source: Geosyntec & GSI Environmental, 2020. Used with permission.

Example of additional information needed to evaluate mitigation options

Evaluation of active/passive mitigation options may require additional information concerning:

- ▶ Sub-slab VOC concentrations
- ▶ Sub-slab soil and moisture conditions
- ▶ Slab integrity
- ▶ Building features that block or short-circuit sub-slab air flow

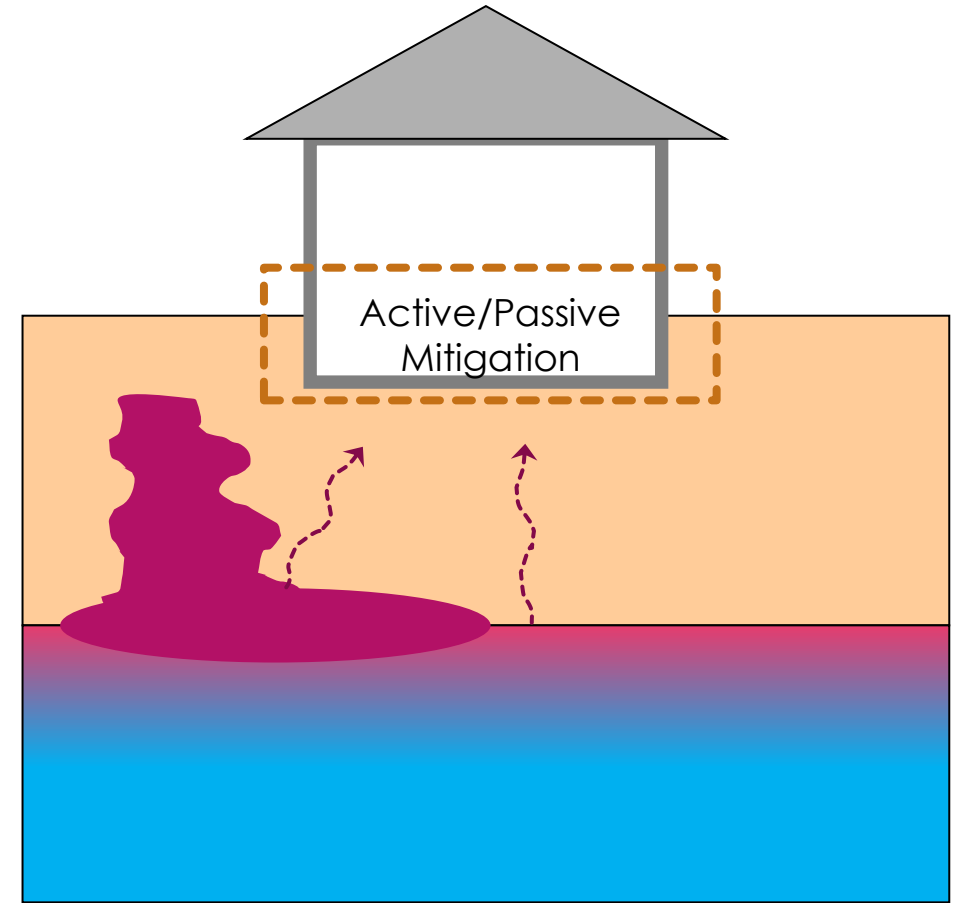

Source: Geosyntec & GSI Environmental, 2020. Used with permission.

Preferential Pathway Considerations

- ▶ The CSM should consider the potential for sewer/pipe preferential pathways
- ▶ Pathways that connect vapor sources to the building can dominate VI
- ▶ Mitigation options must control these pathways (potentially in addition to other pathways)

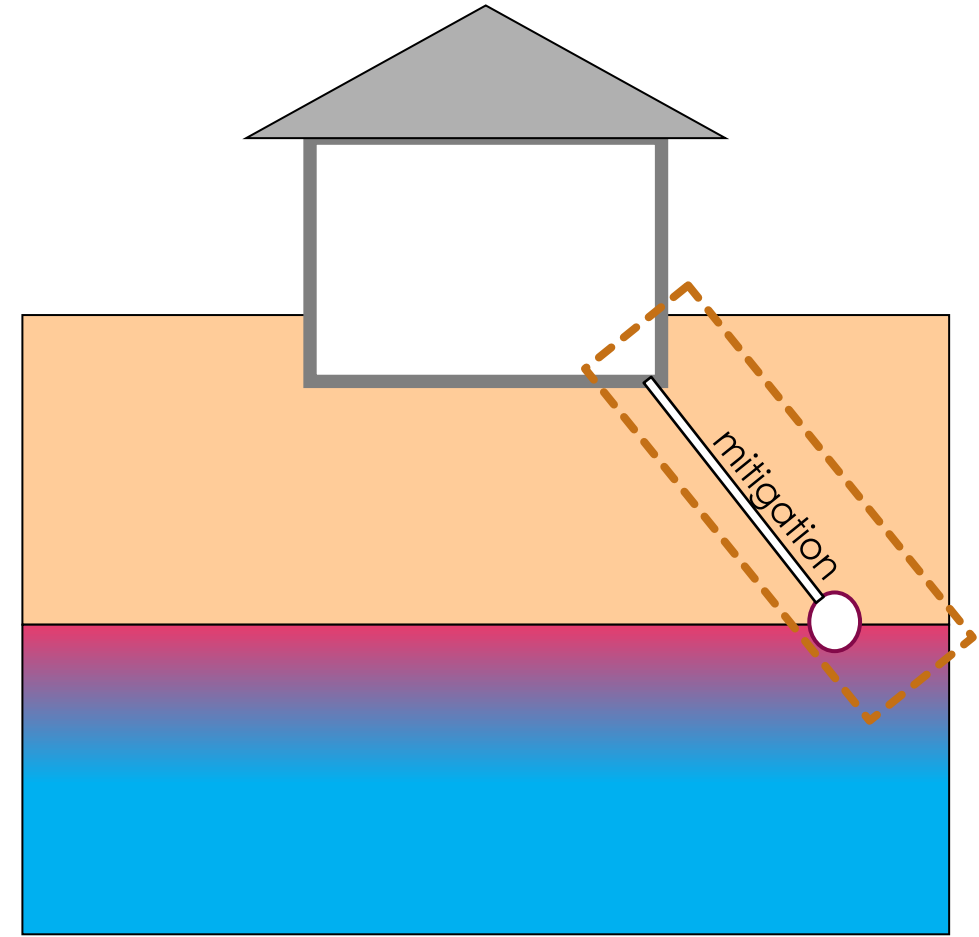

Source: Geosyntec & GSI Environmental, 2020. Used with permission.

Large buildings may have multiple Mitigation CSMs

Example of building with multiple sources, variable pathways, and variable building conditions

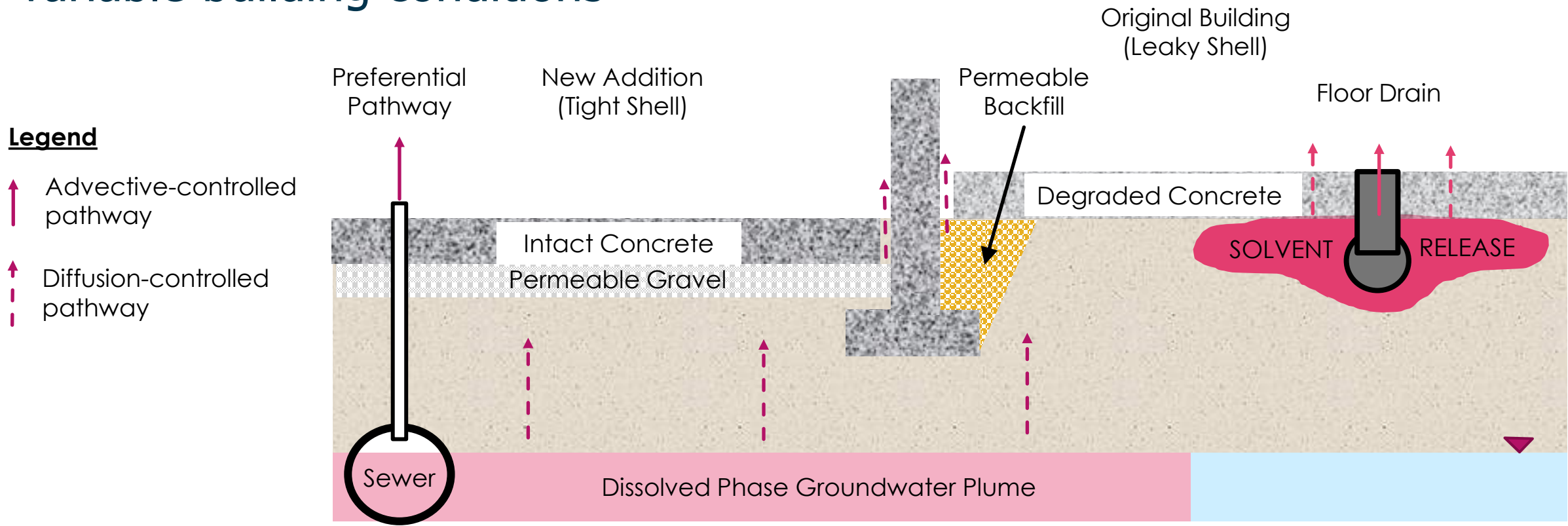

Source: Geosyntec & GSI Consultants, 2020. Used with permission.

Large buildings may have multiple VI pathways

Multiple Mitigation CSMs may require multiple vapor control strategies

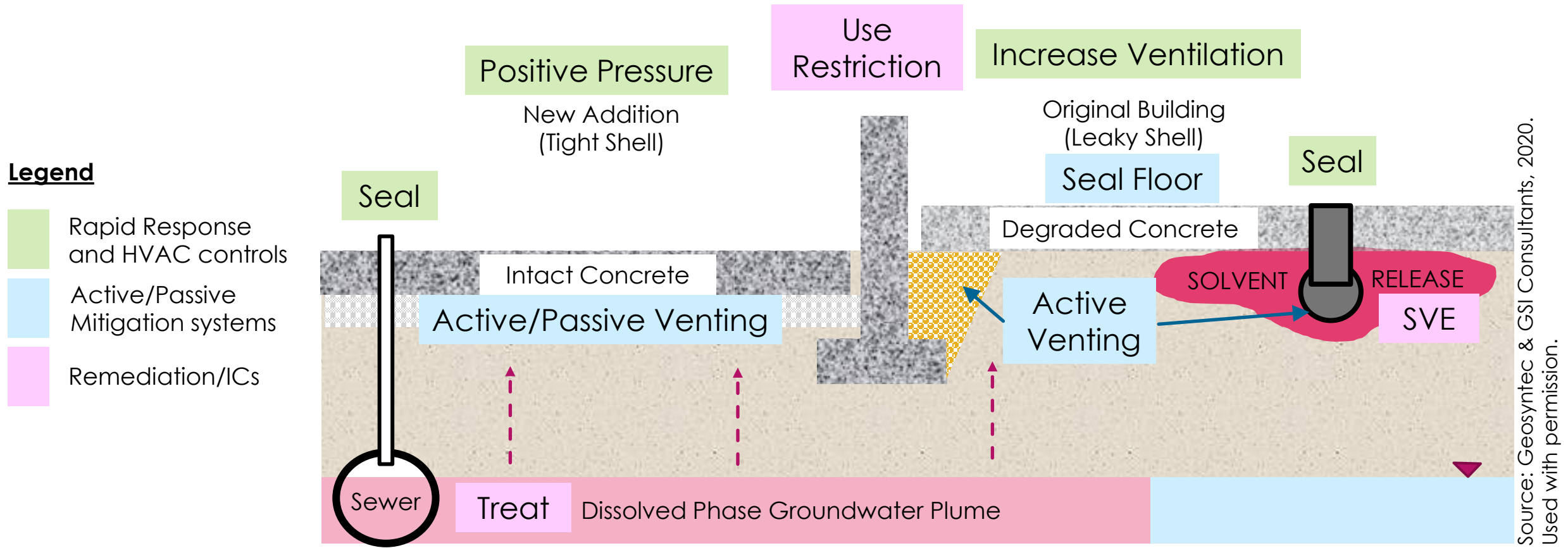

Knowledge Check

What is a component of the Mitigation CSM?

- ▶ Contaminant type
- ▶ Distance between VOC source and building
- ▶ Location and depth of sanitary sewers
- ▶ Condition of building slab
- ▶ All of the above
- ▶ None of the above



Image source: Pixabay

Knowledge Check

What is a component of the Mitigation CSM?

- ▶ Contaminant type
- ▶ Distance between VOC source and building
- ▶ Location and depth of sanitary sewers
- ▶ Condition of building slab
- All of the above
- ▶ None of the above



Source: Pixabay

CSM for VI Mitigation Flow Chart



Receptor
↑
Transport
↑
Source

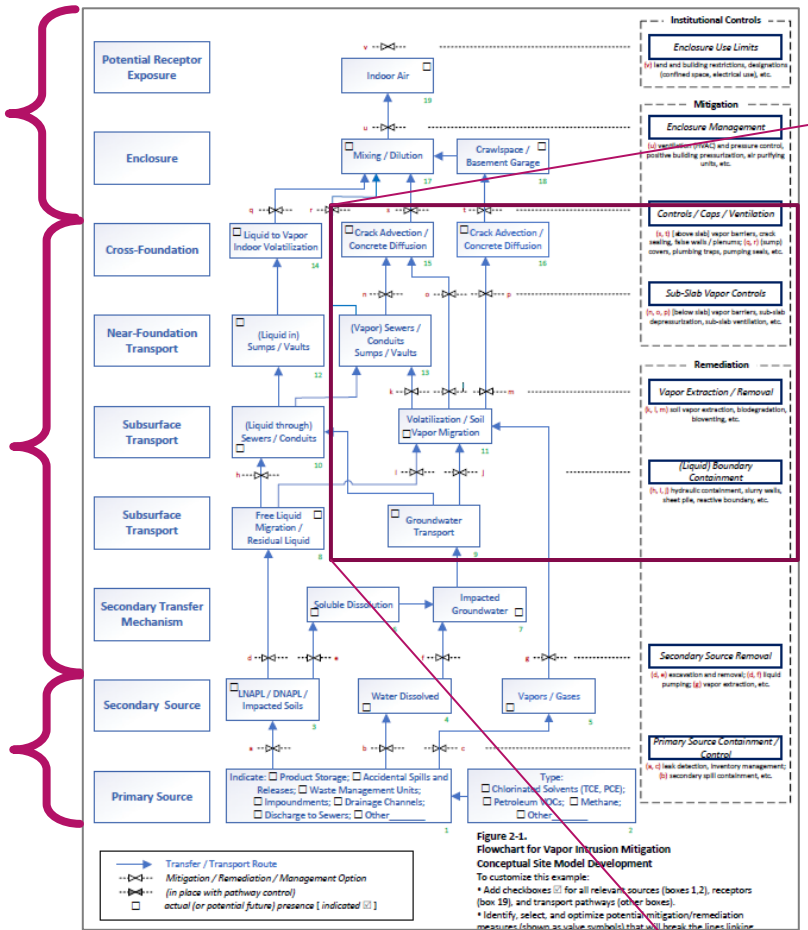
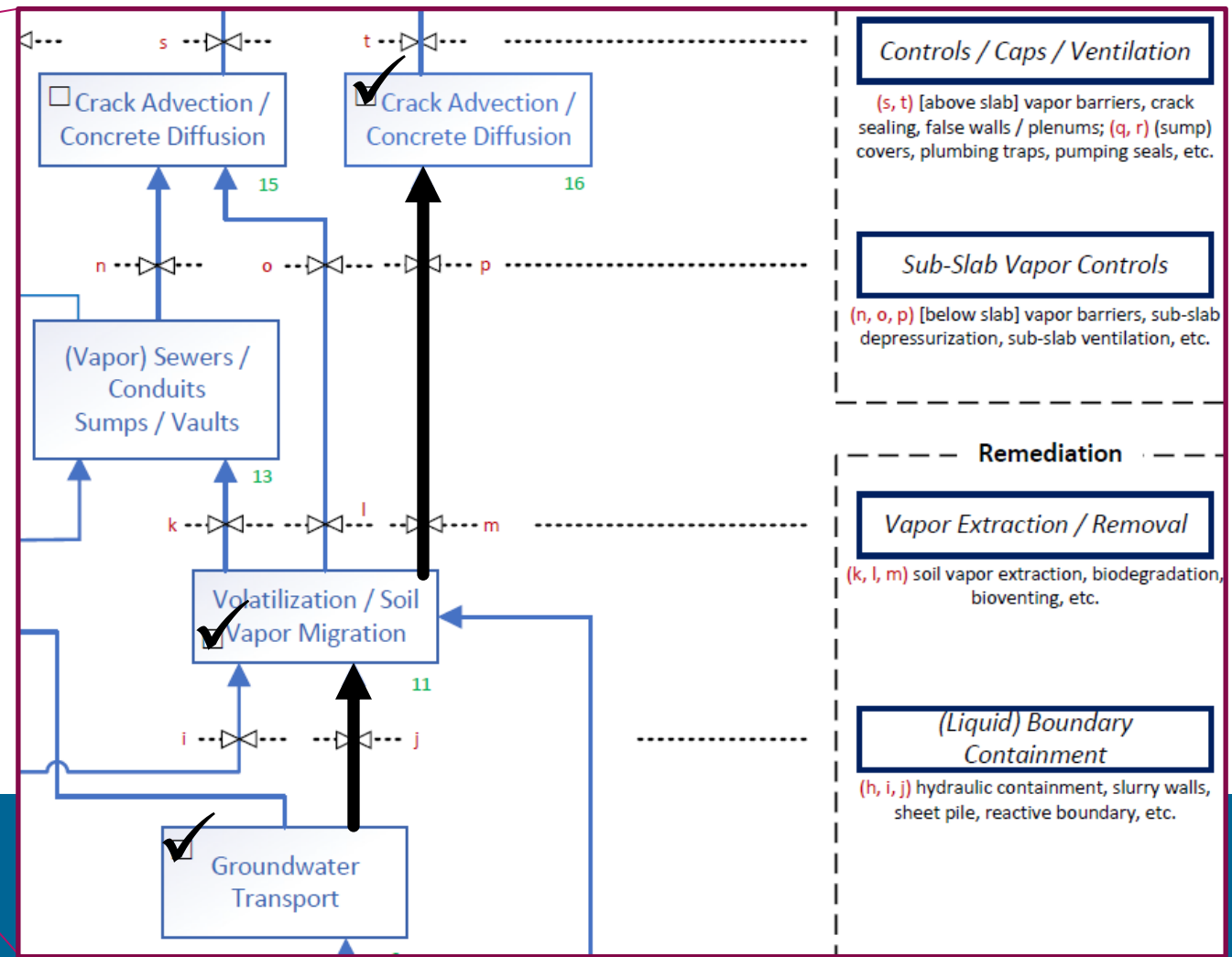

Figure 2-1 of the ITRC CSM Fact Sheet



CSM for VI Mitigation Checklist

- ▶ Supports a systematic site evaluation
- ▶ Helps verify understanding of important details
- ▶ Facilitates data gaps identification

Excerpt of “Building” Section of CSM Checklist

5. Buildings

Locate and map out existing buildings, identify square footage, and identify areas for potential future construction if known. If multiple buildings are being evaluated, tabulation of the following for each building may be necessary. Also, building additions may need to be evaluated separately. Note that a detailed, building-specific evaluation may not be needed if the VI mitigation effort is focused on the COC source area or pathway outside of the **building envelope**. In the descriptions below, include references to site reports, as necessary, to support the discussion. Attachments to this checklist with, for example, copies of figures may also be provided.

5.1 Structure

- Indicate current building use:

Residential

Non-Residential

If non-residential, could future use include residential? Yes No

Unknown

Are land use controls (LUCs), use restrictions, institutional controls, or equivalent in place? Yes No

Note: If current or future site use is or could be residential, the most conservative state and federal regulations apply for technology selection and design.

- Indicate structure status:

Existing construction

New construction

Potential future construction



Knowledge Check

When is it important to verify and update the Mitigation CSM?

- ▶ During mitigation design and planning
- ▶ At the time of mitigation implementation
- ▶ During long-term management
- ▶ All of the above
- ▶ Never



Image source: Pixabay

Knowledge Check

When is it important to verify and update the Mitigation CSM?

- ▶ During mitigation design and planning
- ▶ At the time of mitigation implementation
- ▶ During long-term management
- All of the above
- ▶ Never



Source: Pixabay

Additional CSM Resources

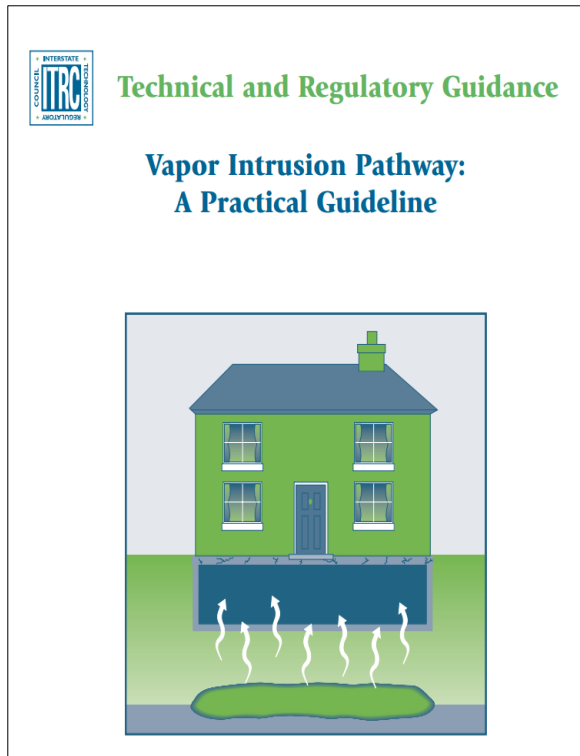

ITRC VI Pathway Guidance (2007)
<https://www.itrcweb.org/Documents/VI-1.pdf>

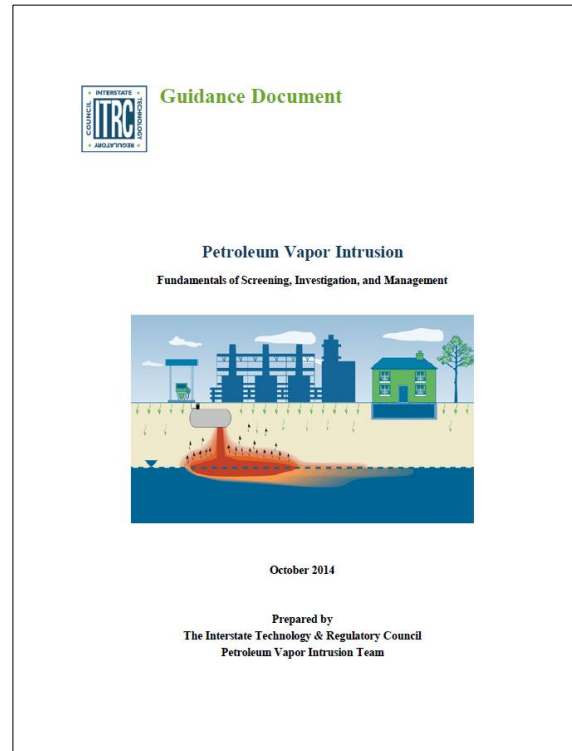

ITRC Petroleum VI Guidance (2014)
Appendix D (PVI CSM Checklist)
<https://www.itrcweb.org/PetroleumVI-Guidance/>

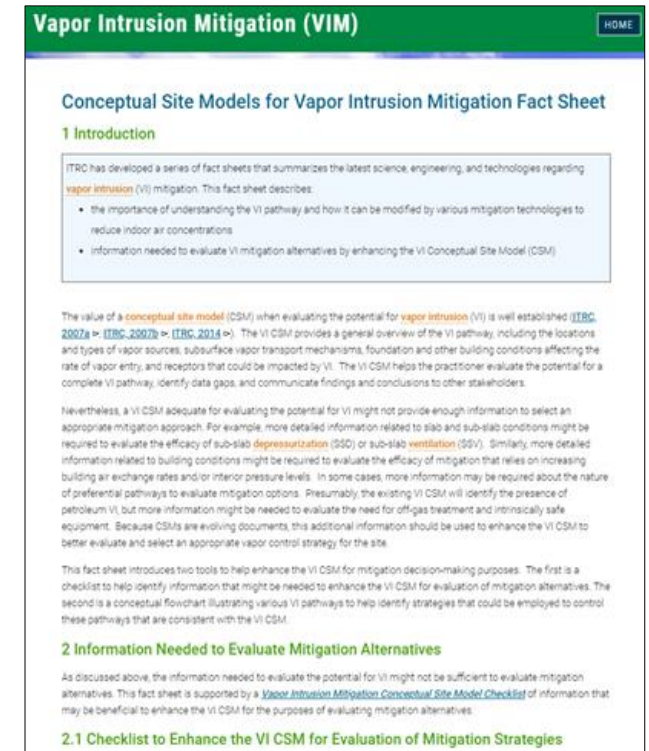

Fact sheet – Conceptual Site Models for Vapor Intrusion Mitigation (2020)
<https://vim-1.itrcweb.org/conceptual-site-models-for-vapor-intrusion-mitigation-fact-sheet/>

Summary

- ▶ VI CSM evolves throughout the life of a project
- ▶ “Mitigation CSM” helps to
 - ▶ Identify information needed to evaluate mitigation options
 - ▶ Support Public Outreach

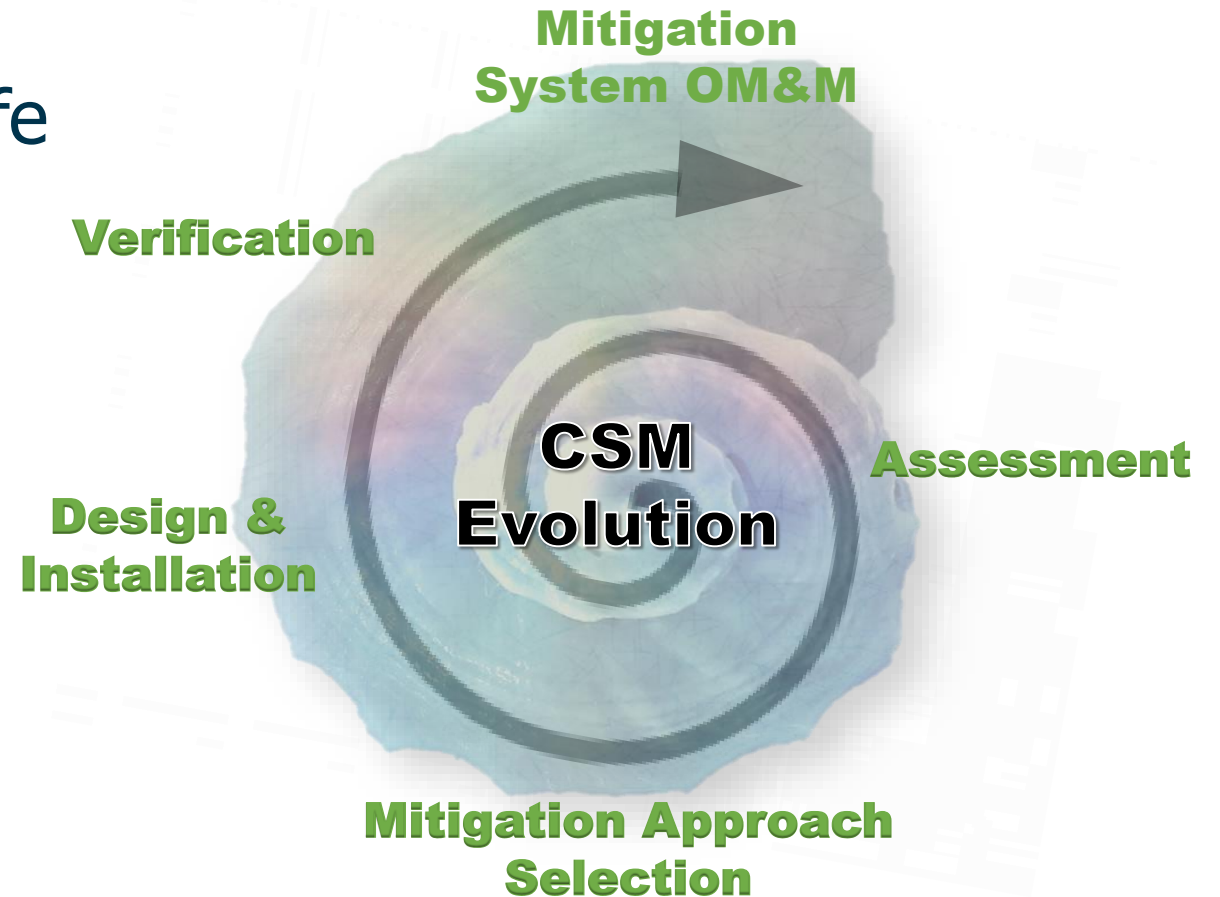

Source: Geosyntec & GSI Environmental, 2020. Used with permission.

Coming Up Next...

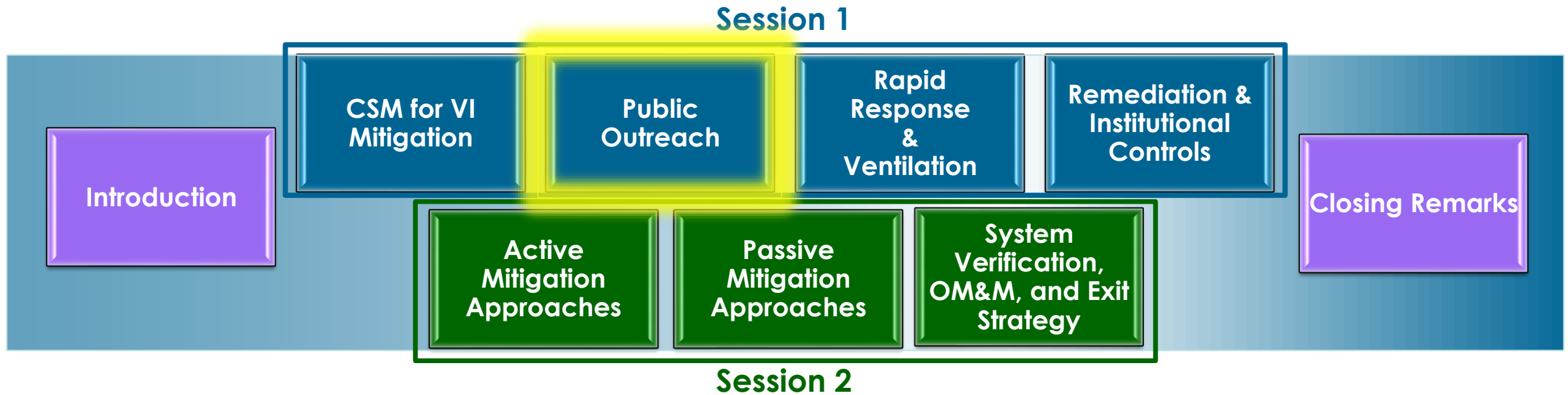



Advancing
Environmental
Solutions

Public Outreach During Vapor Intrusion Mitigation (VIM)



Source: Pixabay



E C O S

ERIS
ENVIRONMENTAL RESEARCH
INSTITUTE OF THE STATES

Objectives of Module

Understand public outreach for VI mitigation:

- ▶ differs from other environmental matters
- ▶ continues through long-term management
- ▶ is diverse, iterative and everyone's job

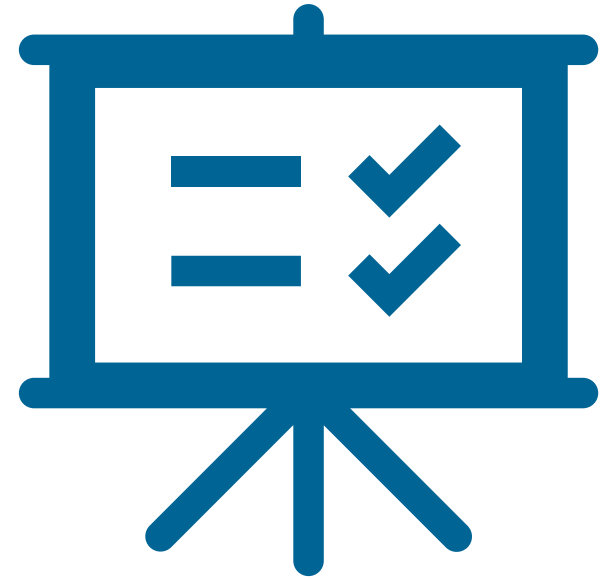

Public Outreach During Vapor Intrusion

- ▶ VI work takes place indoors
- ▶ Topic is unfamiliar to the public
- ▶ It's about the air we breathe
- ▶ Mitigation involves modifications to a building



Key Components of Public Outreach for VI

- ▶ Consider outreach early and often
- ▶ Be transparent
- ▶ Maintain relationships
- ▶ Recruit partners
(e.g., translators, community organizers)
- ▶ Listen

Hi, we're here
to install a vapor
intrusion mitigation
system.



What
questions do
you have?



Communicating Vapor Intrusion Mitigation is Also Complicated

- ▶ Use analogies (e.g., radon mitigation)
- ▶ Address questions and concerns
- ▶ Rely on intermediaries/partners as needed



Questions from the Public



Source: Pixabay (adapted)

Multiple Communication Tools Needed

- ▶ Repeated conversations with same party
- ▶ Emphasize that mitigation protects building occupants
- ▶ Communicate by multiple methods
 - ▶ Group setting
 - ▶ Fact sheets
 - ▶ Social media
 - ▶ One-on-one discussions

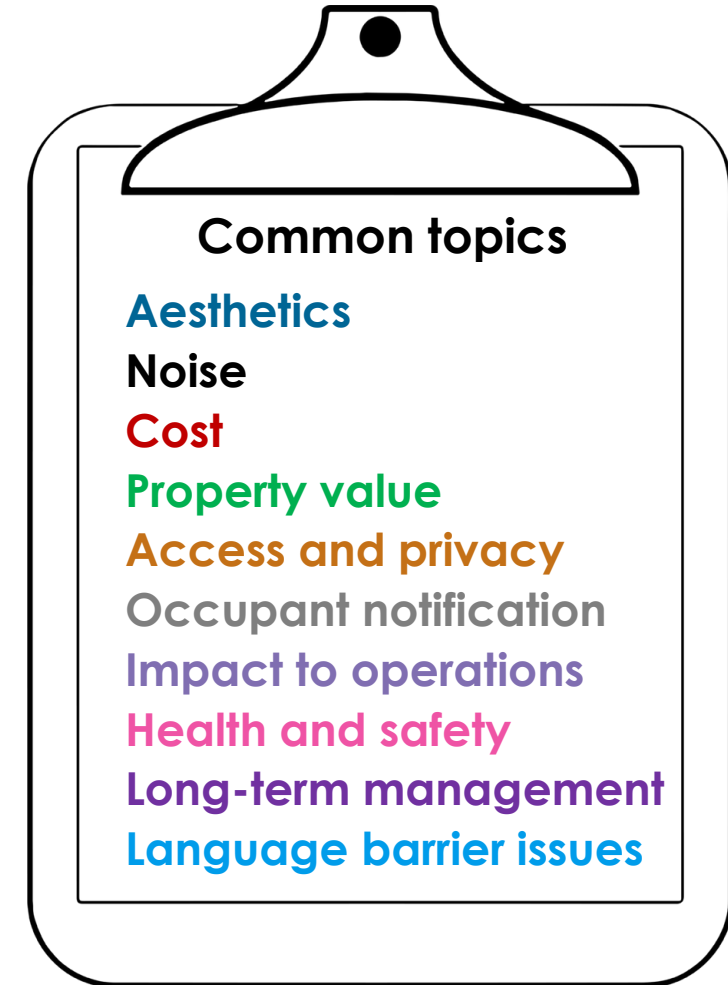

Source:
Pixabay
(adapted)

Communication is Everyone's Job

- ▶ Every interaction and perception matters
- ▶ Every stakeholder plays a role in communication
- ▶ Be mindful of situations where the occupant is not the owner

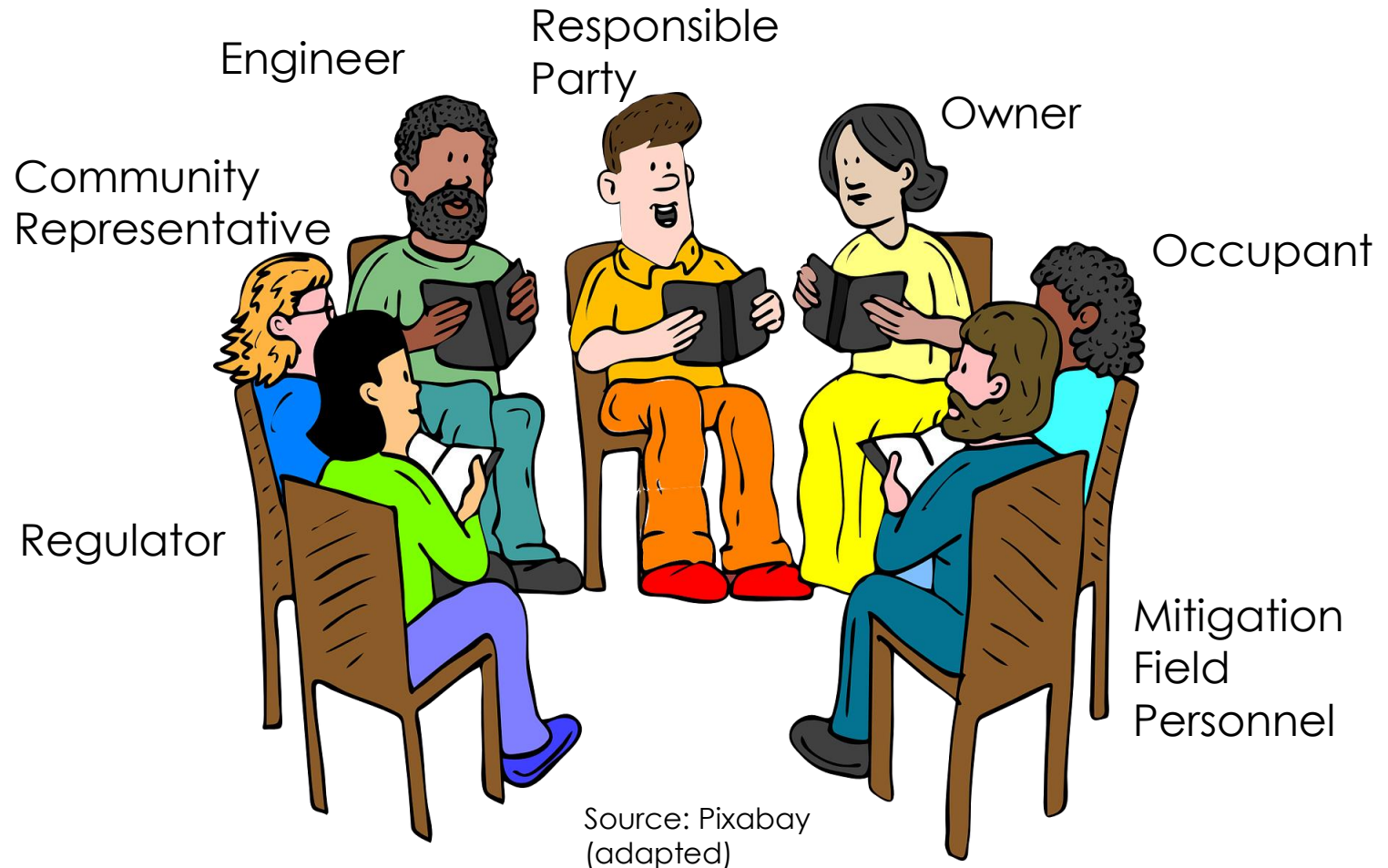

Communication on Long-Term Management

- ▶ Long-term management is a key part of mitigation success
- ▶ Need a plan for communicating:
 - ▶ System issues
 - ▶ Remodeling work
 - ▶ Institutional/engineering controls at property transfer
- ▶ Provide labeling, contact information, and essential documentation
 - ▶ Retain a copy if lost or misplaced

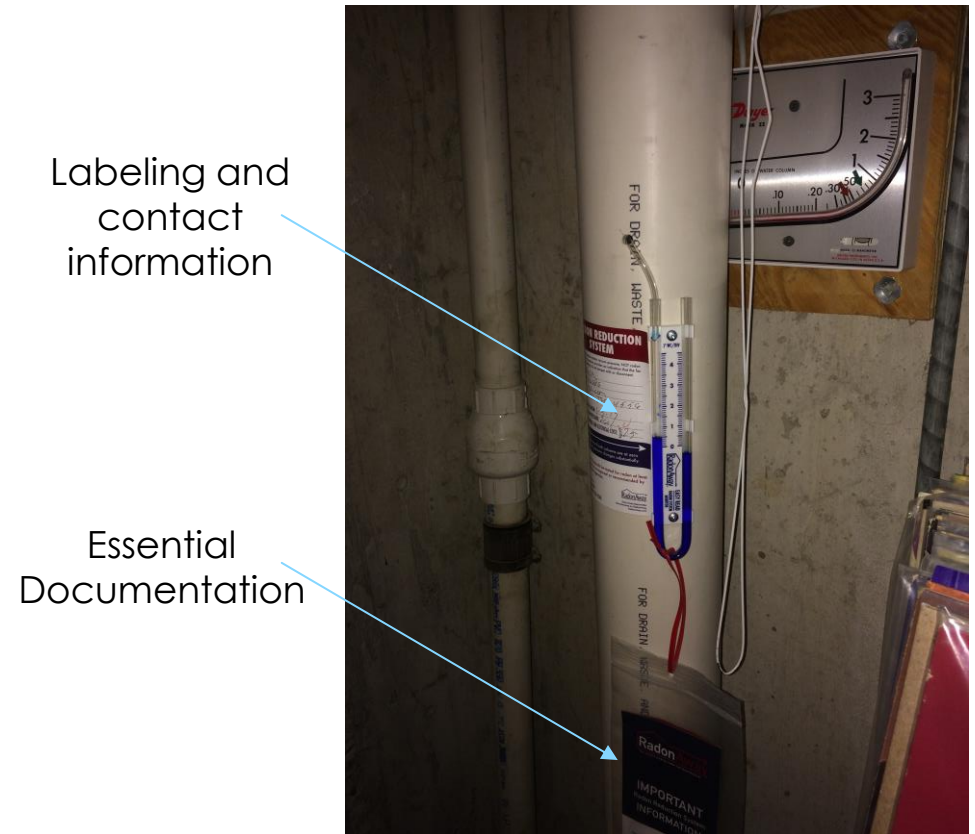

Source: L. Levy, 2020. Used with permission.

Knowledge Check

When is it important to do public outreach?

- ▶ During VI investigation
- ▶ During mitigation design and planning
- ▶ At the time of mitigation implementation
- ▶ During long-term management
- ▶ All the above



Image source: Pixabay

Knowledge Check

When is it important to do public outreach?

- ▶ During VI investigation
 - ▶ During mitigation design and planning
 - ▶ At the time of mitigation implementation
 - ▶ During long-term management
- All the above



Source: Pixabay

Additional Resources

VIM HOME

Public Outreach during Vapor Intrusion Mitigation

ITRC has developed a series of fact sheets that summarize the latest science, engineering, and technologies regarding vapor intrusion (VI) mitigation. This fact sheet describes:

- common concerns of communities affected by VI
- specific vapor intrusion considerations for development of a Community Engagement Plan
- references to support preparation of a Community Engagement Plan

1 Introduction

It is important to engage the public at environmental contamination sites, but at vapor intrusion sites it is *essential* to engage the people who own, live, work or study in, or otherwise occupy impacted buildings. Their cooperation, not just permission, makes it possible to investigate, remediate, mitigate, and monitor properties contaminated with hazardous substances. You may be asking them to agree to allow intrusive or disruptive activities such as drilling holes through their floors, attaching fans and piping to their buildings, or rearranging their basements for investigation or mitigation.

Before the first announcement or knock on a door, the environmental team should implement a Community Engagement Plan that recognizes the unique character of each community and the form of planned investigation or mitigation. While the contents and logistics of a Community Engagement Plan for a vapor intrusion issue are listed separately below, they are integrally related and will need to be developed together.

2 Possible Community Concerns for the Community Engagement Plan

Characterizing the community and listening to affected parties to determine their concerns are the first steps in developing a Community Engagement Plan. Some common concerns are listed in Table 2-1. The initial characterization will help determine when, where, and how to communicate in the future with the affected parties.

Occupant/Use	Possible Concerns					
	Communication Language Barriers	Operational Impact	Property Value (increase or decrease)	Health and Safety	Cooperation/Trust	Access/Privacy

Fact sheet – Public Outreach During Vapor Intrusion Mitigation (2020)

<https://vim-1.itrcweb.org/public-outreach-during-vapor-intrusion-mitigation/>

Guidance Document

Petroleum Vapor Intrusion
Fundamentals of Screening, Investigation, and Management



October 2014

Prepared by
The Interstate Technology & Regulatory Council
Petroleum Vapor Intrusion Team

ITRC Petroleum VI Guidance (2014) Section 7 Community Engagement

<https://www.itrcweb.org/PetroleumVI-Guidance/>

Risk Communication Toolkit HOME



Welcome

Risk Communication Toolkit

This Interstate Technology and Regulatory Council (ITRC) online document includes a brief overview of risk communication (Section 1), walks through the steps in developing a communication plan and stakeholder outreach activities (Section 4), presents an overview of risk communication concepts (Section 2), and applies these principles in case studies (Section 5) to facilitate risk communication plan development. Section 3.2 includes a summary of the tools included in the appendices (See Section 6 Additional Information) to facilitate risk communication plan development and stakeholder outreach activities. This toolkit is applicable to current, immediate, and emerging environmental issues and concerns. Examples of various tools, as presented in this toolkit, were developed by issue-specific ITRC teams; however, they are generally applicable to environmental issues and concerns. Additional examples will be developed by ITRC teams going forward and linked to the web document in the future. This toolkit will be updated with links to case studies published by future ITRC teams.

A short [Risk Communication Toolkit fact sheet](#) summarizing the information in this online document is available.

As part of the PFAS team training videos, a Risk Communication video has been developed. It is posted on ITRC's YouTube channel: <https://www.youtube.com/watch?v=Hq0aPip-z5g&feature=youtu.be>

Document navigation is provided with the menu on the left, or above on a mobile device.

Publication Date: June 2020

 Print this page/section

ITRC Risk Communication Toolkit (2020)

<https://rct-1.itrcweb.org/>

Question & Answer Break



Source: Pixabay



Advancing
Environmental
Solutions

Rapid Response for Vapor Intrusion Mitigation

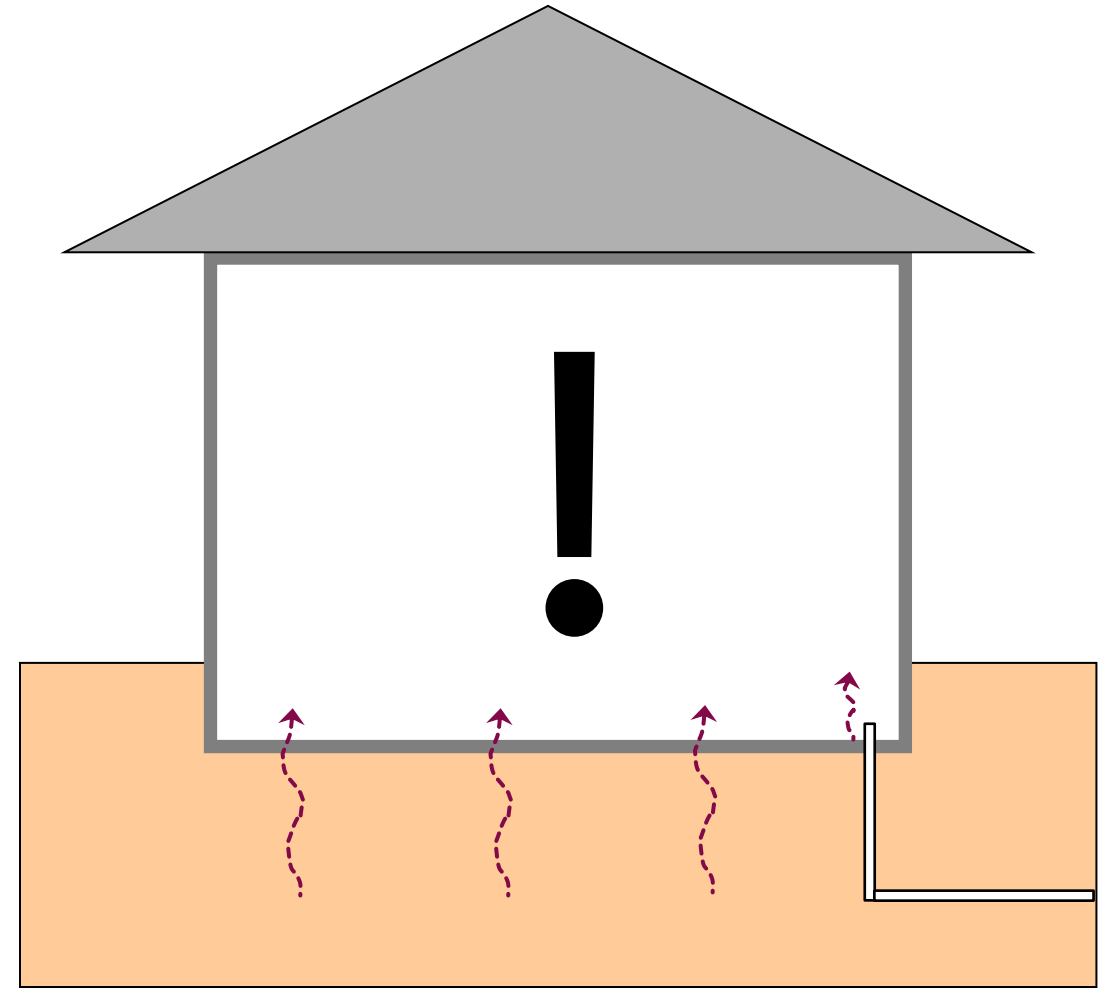

Source: Barr Engineering, 2020. Used with permission.



ECOS

ERIS
ENVIRONMENTAL RESEARCH
INSTITUTE OF THE STATES

Objectives of Module

- ▶ Definition of rapid response for vapor intrusion mitigation
- ▶ Overview
- ▶ When to implement
- ▶ Administrative and engineering controls for rapid responses

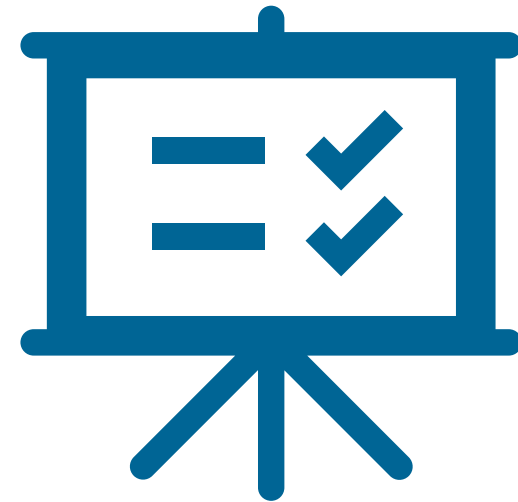

What is Rapid Response?

- ▶ Mitigation implemented within days or weeks of vapor intrusion discovery
- ▶ Addresses acute public health risk
- ▶ Interim response action
- ▶ May be different from final response
 - ▶ Limited design effort
 - ▶ Different verification testing considerations
 - ▶ Limited OM&M

Other Terms for Rapid Response

imminent hazard response
urgent response
emergency response
expedited response
immediate response
accelerated response

What is not covered in these presentations

- ▶ Emergency response actions –
Immediately contact first responders if
 - ▶ Reports of strong petroleum odors
 - ▶ Evidence of combustible, explosive, or oxygen-deficient conditions inside the building
- ▶ Methane mitigation or hazardous substances that have a high explosive potential
- ▶ Radon



Source: ITRC Petroleum VI Guidance (2014)

Knowledge Check

Which of these scenarios could warrant a rapid response?

- A. Petroleum vapor intrusion has been documented in a vacant gas station
- B. High levels of TCE have been detected in sub-slab soil gas at maternity clinic
- C. TCE levels have been detected slightly above state vapor intrusion action levels at an occupied commercial building
- D. Benzene has been detected at high levels in soil gas at a vacant lot planned for redevelopment



Image source: Pixabay

Knowledge Check

Which of these scenarios could warrant a rapid response?

- A. Petroleum vapor intrusion has been documented in a vacant gas station
- B. High levels of TCE have been detected in sub-slab soil gas at maternity clinic
- C. TCE levels have been detected slightly above state vapor intrusion action levels at an occupied commercial building
- D. Benzene has been detected at high levels in soil gas at a vacant lot planned for redevelopment



Source: Pixabay

Rapid Response & Ventilation Fact and Tech Sheets

- ▶ Defines what is a rapid response and when to implement
- ▶ Lists administrative and engineering controls for rapid responses

Vapor Intrusion Mitigation (VIM)

[HOME](#)

Rapid Response & Ventilation for Vapor Intrusion Mitigation Fact Sheet

ITRC has developed a series of fact sheets that summarizes the latest science, engineering, and technologies regarding [vapor intrusion](#) (VI) mitigation. The fact sheets are tailored to the needs of state regulatory program personnel who are tasked with making informed and timely decisions regarding VI-impacted sites. The content is also useful to consultants and parties responsible for the release of these contaminants, as well as public and tribal stakeholders. This fact sheet:

- provides an overview of rapid response as a preliminary method to consider
- describes the typical options related to rapid response
- describes the advantages and limitations of implementing a rapid response
- provides general cost considerations related to rapid response
- describes other special circumstances to consider when deciding if rapid response is applicable

More detailed information on specific rapid response options is included in the ITRC [Preferential Pathway Sealing and Ad Hoc Ventilation](#), [Indoor Air Treatment](#), and [HVAC Modification Technology Information Sheets](#).

1 Introduction

Rapid response is an interim VI mitigation approach that may be appropriate, under certain conditions (e.g., high contaminant concentrations and sensitive populations present), prior to implementing a long-term [mitigation strategy](#) for an occupied room or building. For the purposes of this fact sheet, a rapid response is one that could be easily implemented and verified on a timescale of days to weeks, whereas a long-term [mitigation strategy](#) typically

Other Terminology Used to Describe a Rapid Response

- Depending on the regulatory framework and the measured indoor or subsurface concentrations for the chemical(s) of concern, the term "rapid response" can correspond to one or more of the following:

<https://vim-1.itrcweb.org/rapid-response-ventilation-for-vapor-intrusion-mitigation-fact-sheet/>

Rapid Response Focused on Structure and Occupants

- ▶ Building occupants
- ▶ Preferential pathways
- ▶ Building pressure
- ▶ Air exchange rate

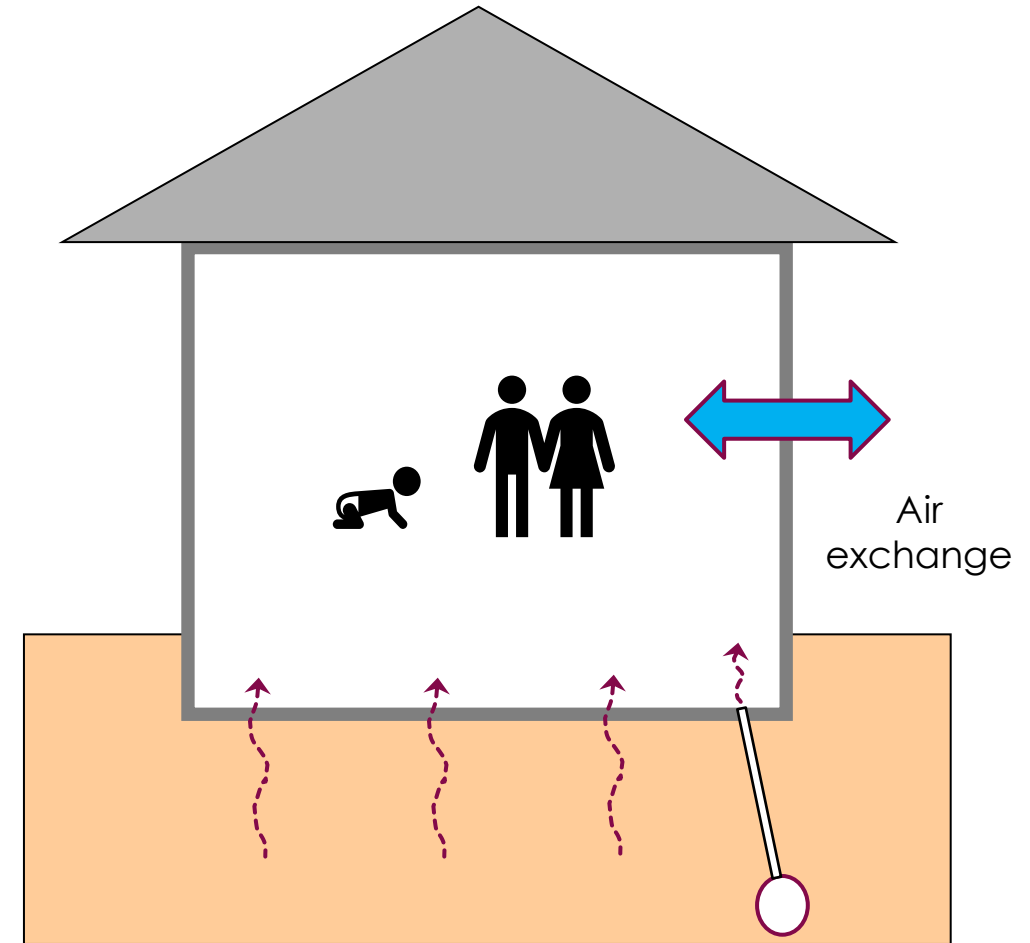

Source: Barr Engineering, 2020. Used with permission.

Categories of Rapid Response

Administrative Controls

- ▶ Notification
- ▶ Relocation

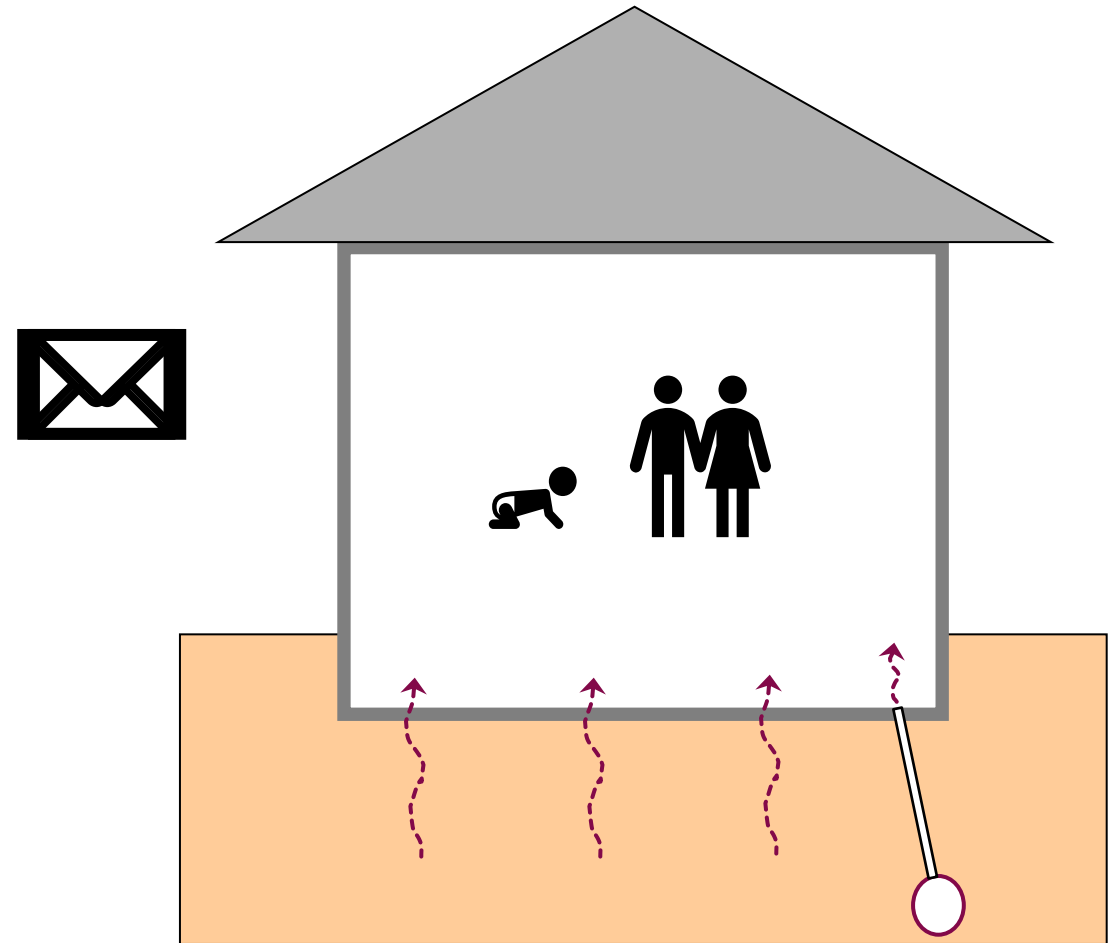

Source: Barr Engineering, 2020. Used with permission.

Categories of Rapid Response Engineering Controls

- ▶ Preferential pathway sealing
- ▶ Ad hoc ventilation

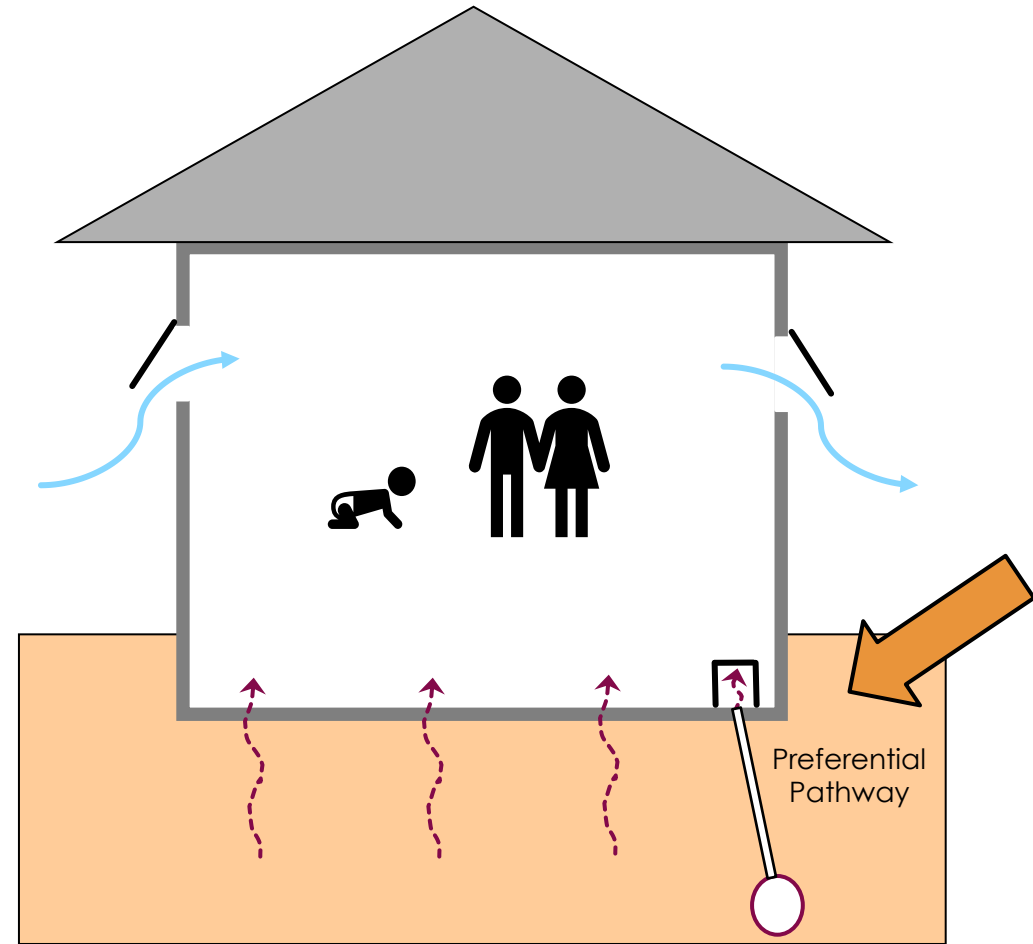

Source: Barr Engineering, 2020. Used with permission.

Categories of Rapid Response Engineering Controls

- ▶ Preferential pathway sealing
- ▶ Ad hoc ventilation
- ▶ Indoor air treatment

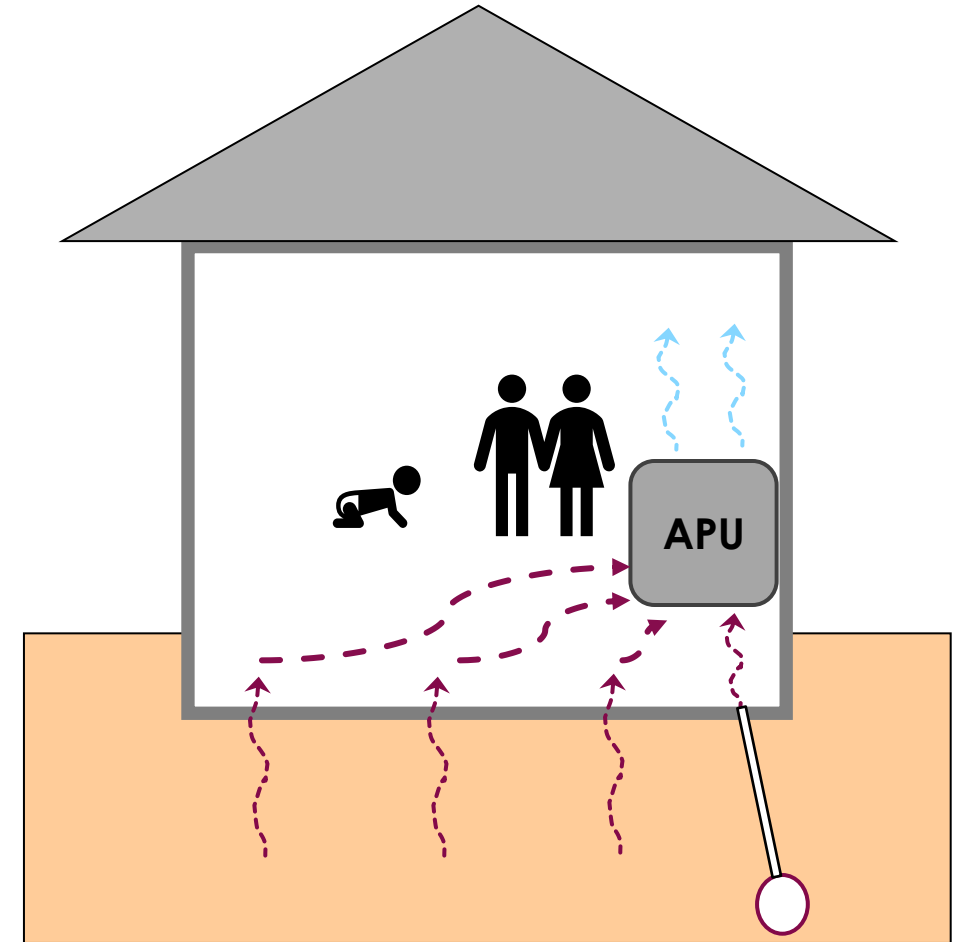

Source: Barr Engineering, 2020. Used with permission.

Categories of Rapid Response Engineering Controls

- ▶ Preferential pathway sealing
- ▶ Ad hoc ventilation
- ▶ Indoor air treatment
- ▶ HVAC modification

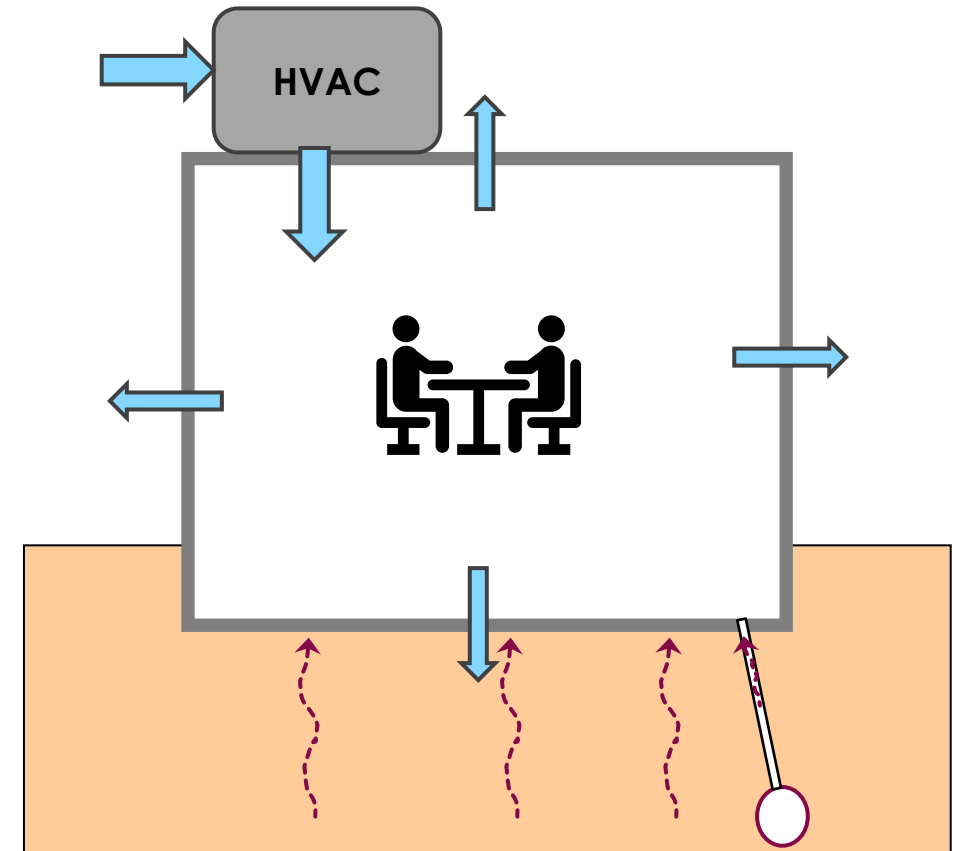

Source: Barr Engineering, 2020. Used with permission.

Rapid Response & Ventilation Technology Information Sheets

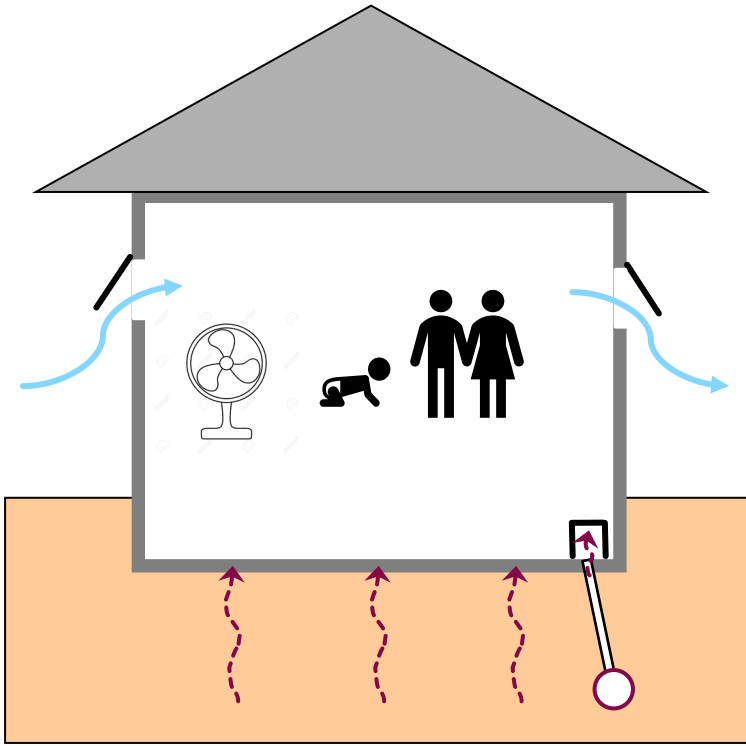

Preferential Pathway Sealing and
Ad Hoc Ventilation

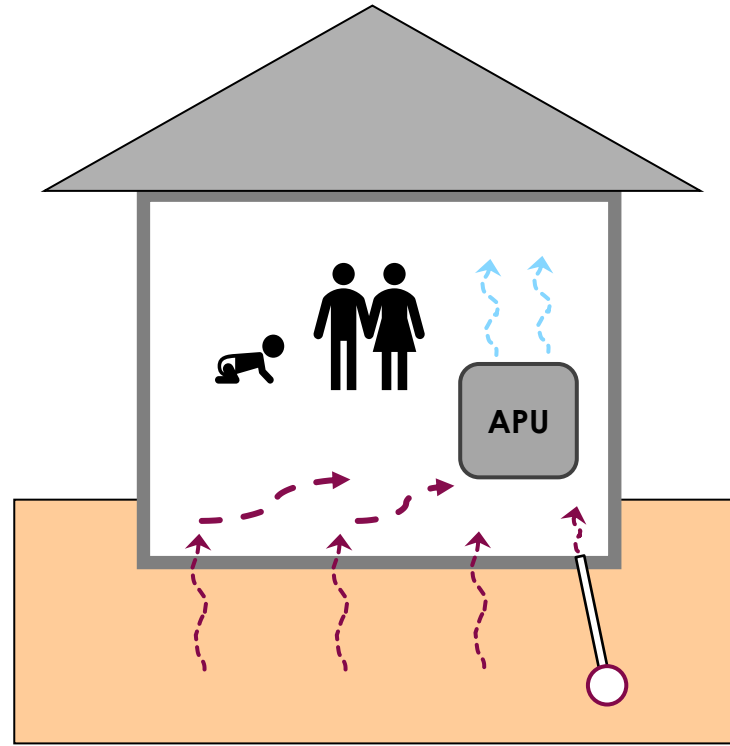

Indoor Air Treatment

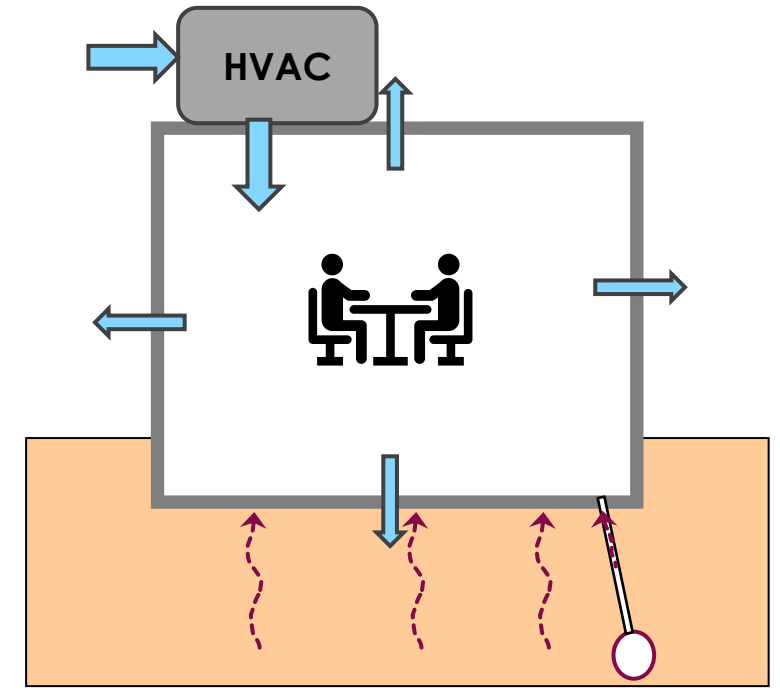

HVAC Modification

Source: Barr Engineering, 2020. Used with permission.

Poll

Which of these administrative and engineering controls have you implemented or seen implemented? (Check all that apply)

- A. Notification
- B. Relocation
- C. Preferential Pathway Sealing and Ad Hoc Ventilation
- D. Indoor Air Treatment
- E. HVAC Modification



Source: Clipartmax.com

Tech Sheet – Preferential Pathway Sealing

Overview

- ▶ Advection vs. Diffusion
- ▶ Preferential pathway sealing blocks advection
 - ▶ Benefits long-term mitigation

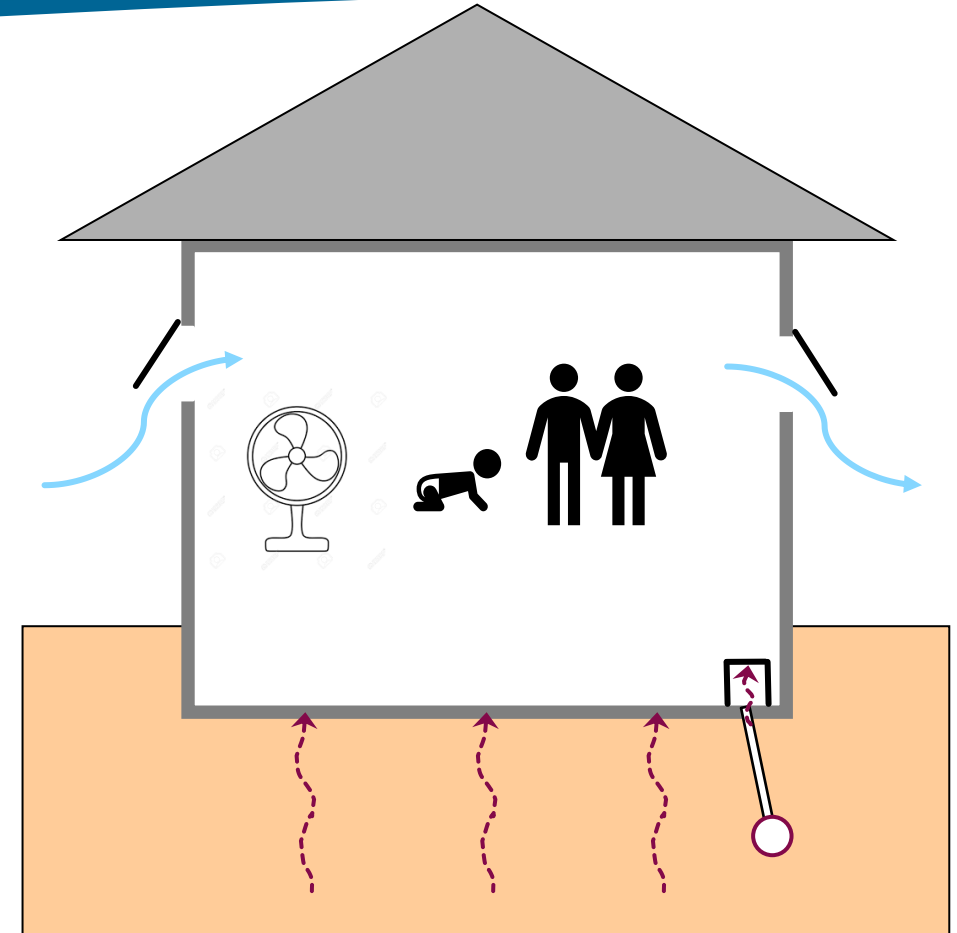

Source: Barr Engineering, 2020. Used with permission.

<https://vim-1.itrcweb.org/preferential-pathway-sealing-ad-hoc-ventilation-tech-sheet/>

Tech Sheet – Ad Hoc Ventilation

Overview

- ▶ Ad hoc ventilation = dilution
 - ▶ Weather dependent

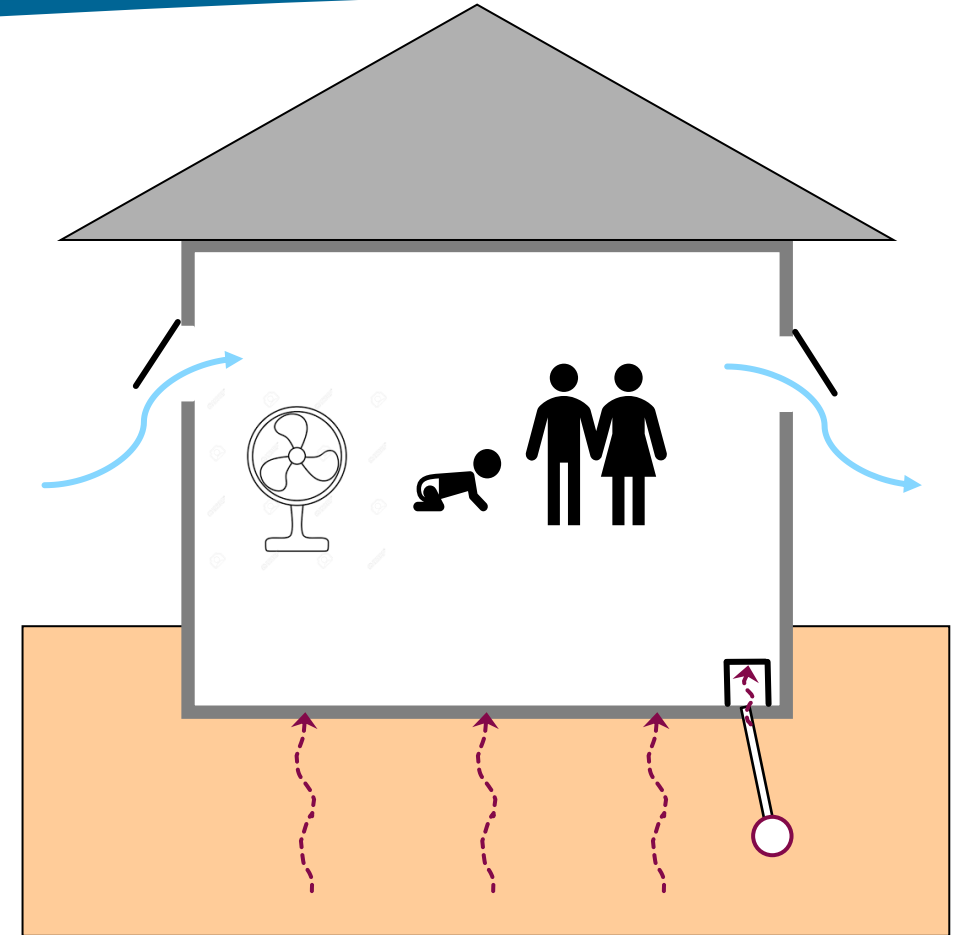

Source: Barr Engineering, 2020. Used with permission.

<https://vim-1.itrcweb.org/preferential-pathway-sealing-ad-hoc-ventilation-tech-sheet/>

Preferential Pathway Sealing Components



Source: Sanborn, Head & Associates, Inc.

Sealant applied to floor gap

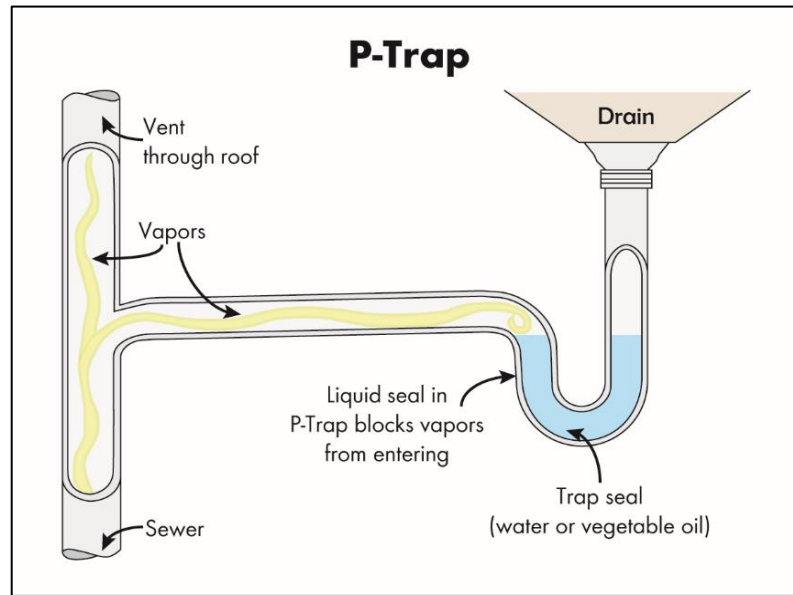

Source: Barr Engineering Co.

Add water to dry drain

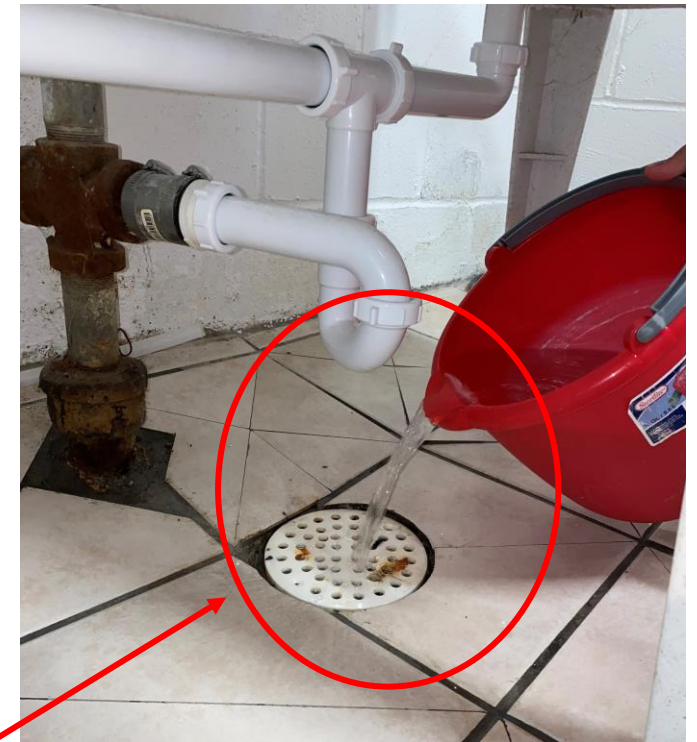

Source: Barr Engineering Co.

Tech Sheet – Indoor Air Treatment

Overview

- ▶ Implemented via air purifying units (APUs)
- ▶ Treats air inside building
- ▶ Subject to human interference

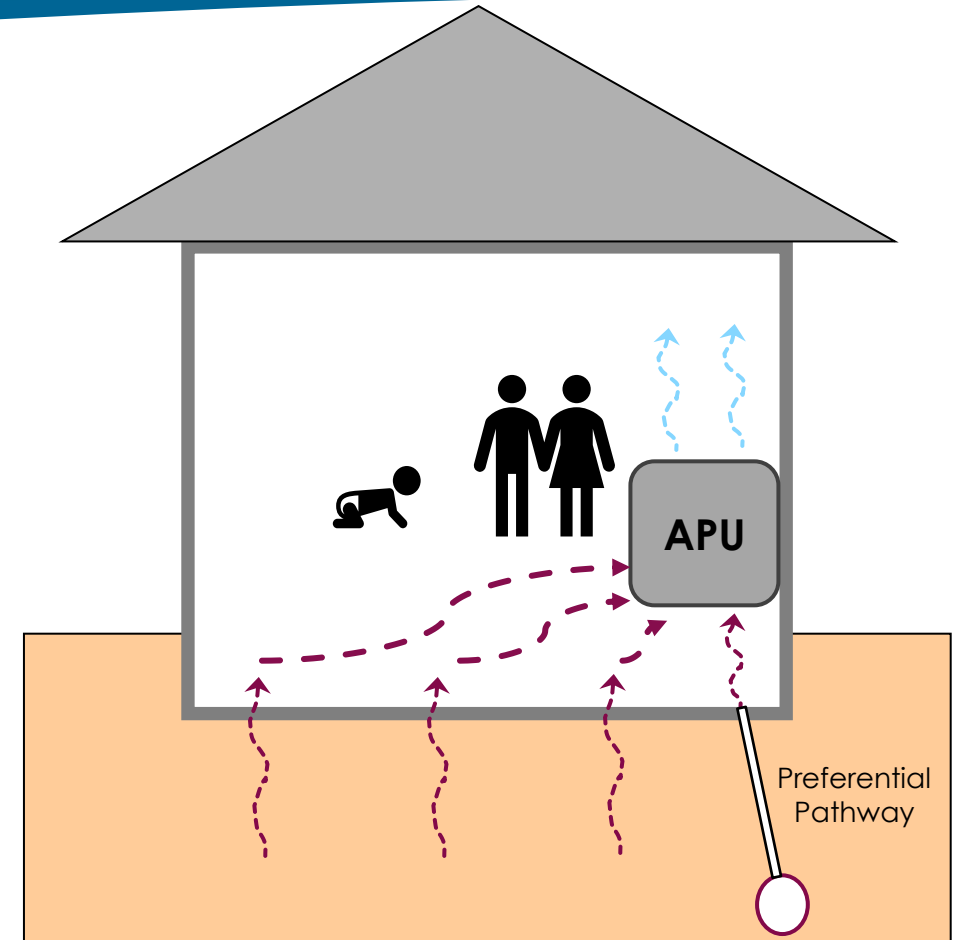

Source: Barr Engineering, 2020. Used with permission.

<https://vim-1.itrcweb.org/indoor-air-treatment-tech-sheet/>

Tech Sheet – Indoor Air Treatment Components

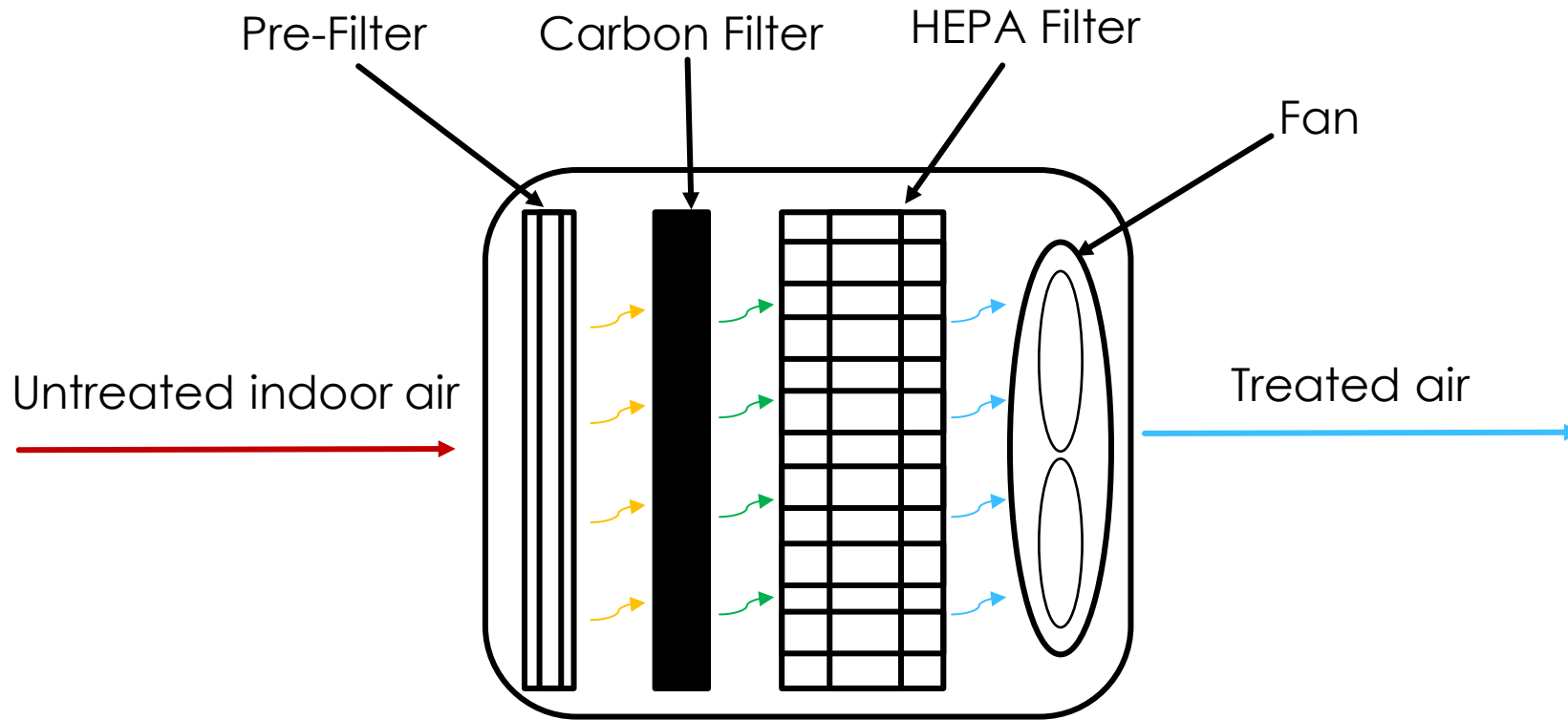

Example adsorption-based APU

Source: Sanborn, Head & Associates, 2021. Used with permission.



Photograph from Figure 1 of the Indoor Air Treatment Technology Information Sheet.

Tech Sheet – HVAC Modification

Overview

- ▶ Increase air exchange rate
- ▶ Increase building pressure
- ▶ Most suitable for commercial/industrial buildings
- ▶ Can supplement other mitigation methods

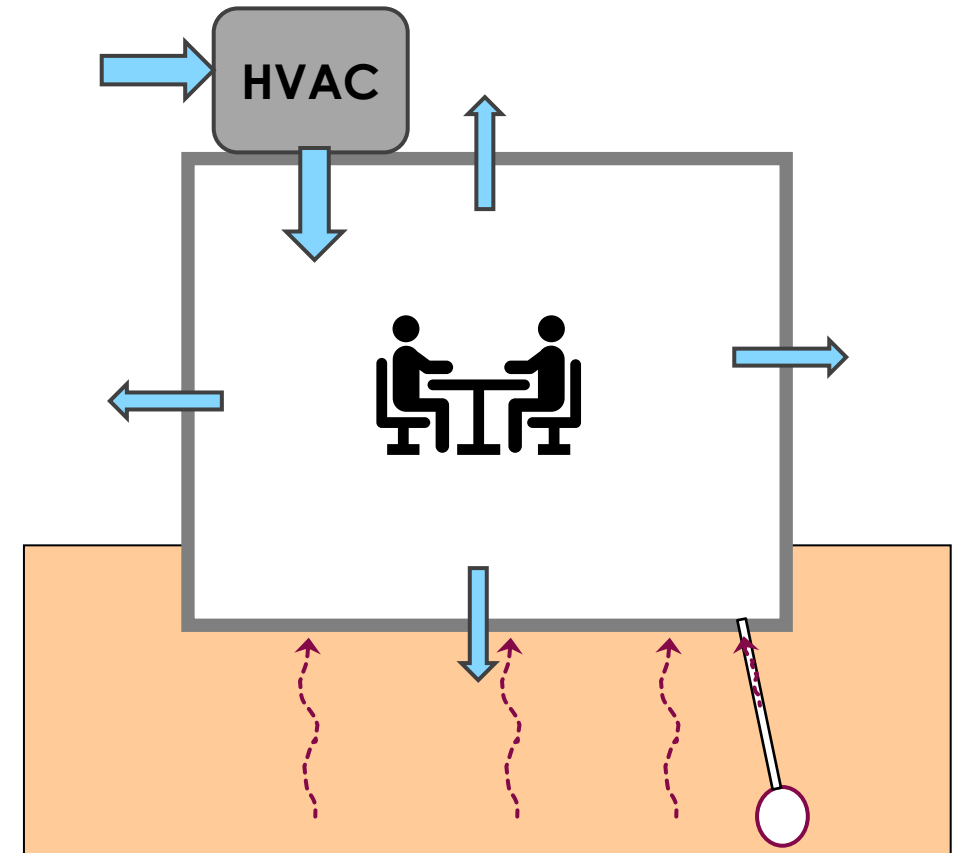

<https://vim-1.itrcweb.org/heating-ventilation-and-air-conditioning-hvac-modification-tech-sheet/>

Tech Sheet – HVAC Modification Components

Fresh outside air enters the HVAC unit through dampers and is distributed via a supply fan

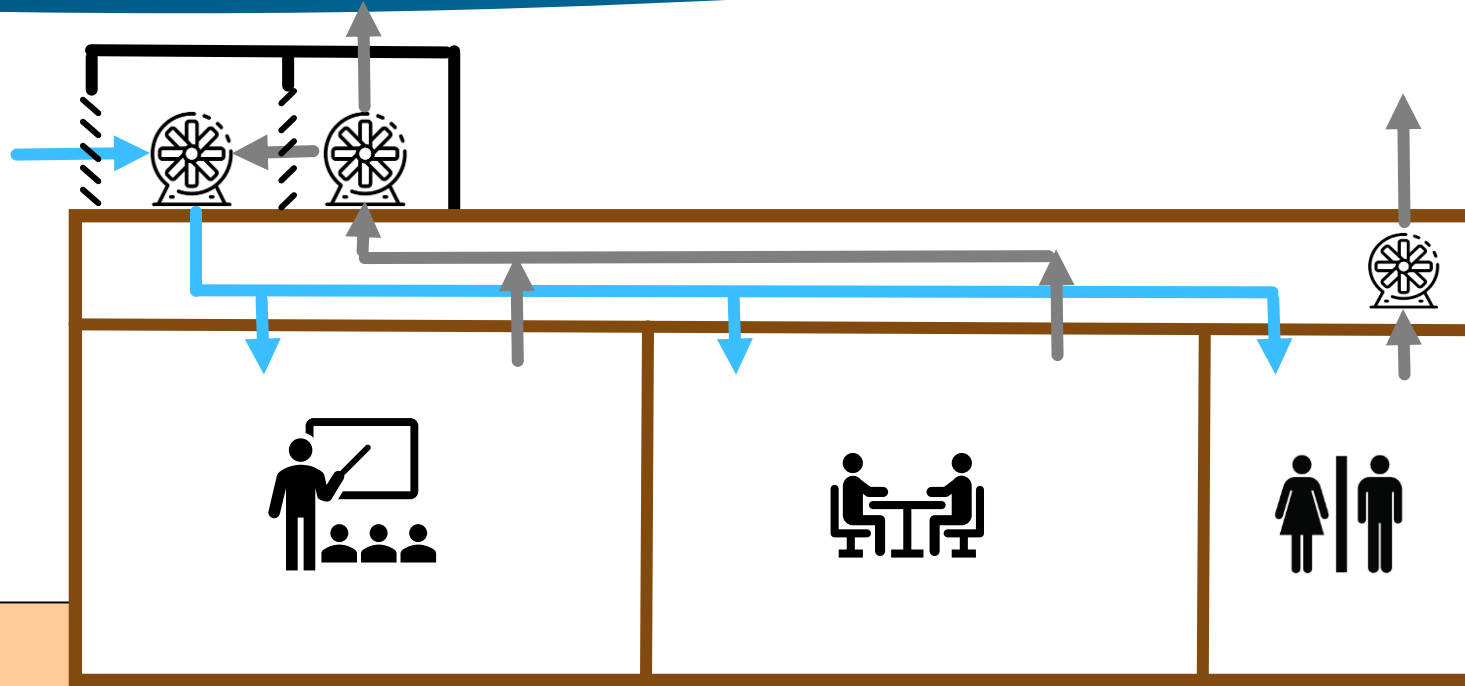

<https://vim-1.itrcweb.org/heating-ventilation-and-air-conditioning-hvac-modification-tech-sheet/>

Source: Sanborn, Head & Associates, 2020. Used with permission.

Tech Sheet – HVAC Modification Components

Indoor air is collected by the return air fan and is reused as makeup air, or discharged from the building

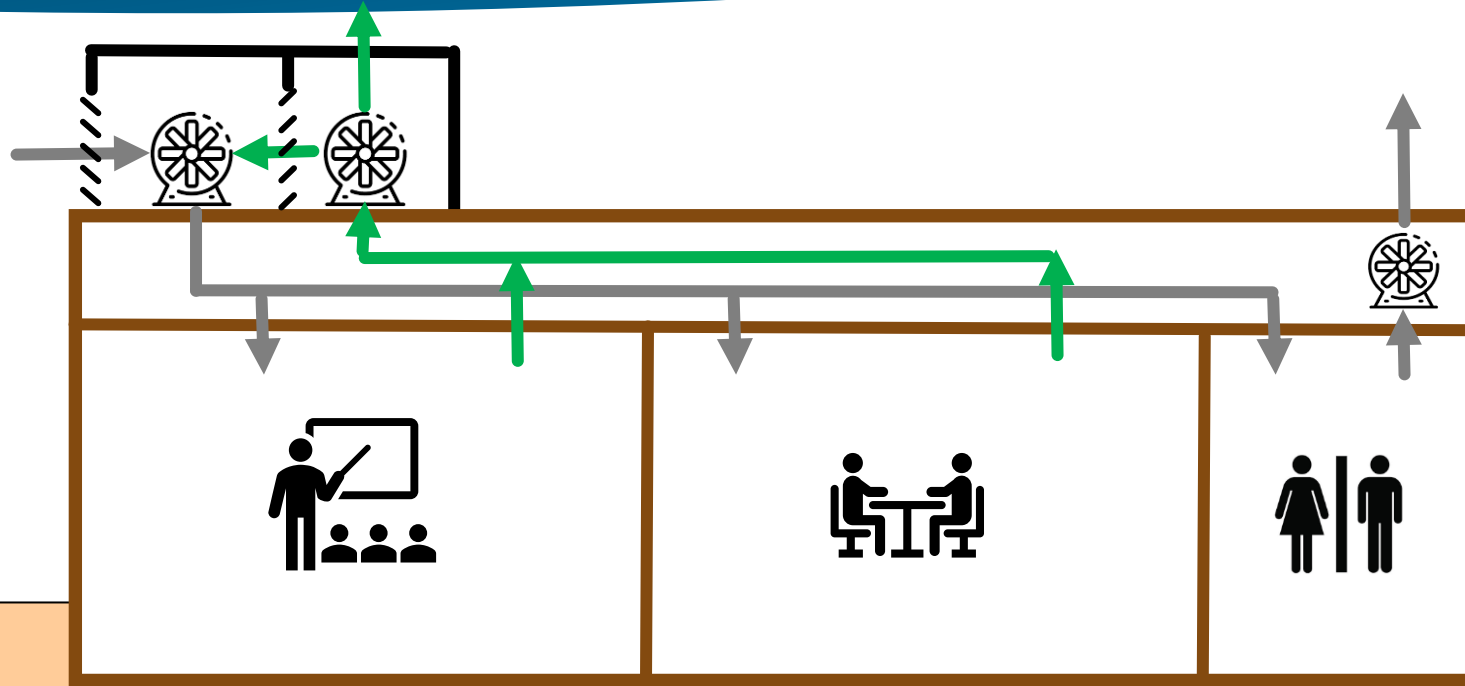

<https://vim-1.itrcweb.org/heating-ventilation-and-air-conditioning-hvac-modification-tech-sheet/>

Source: Sanborn, Head & Associates, 2020. Used with permission.

Tech Sheet – HVAC Modification Components

Some indoor air is directly exhausted from the building via exhaust fans

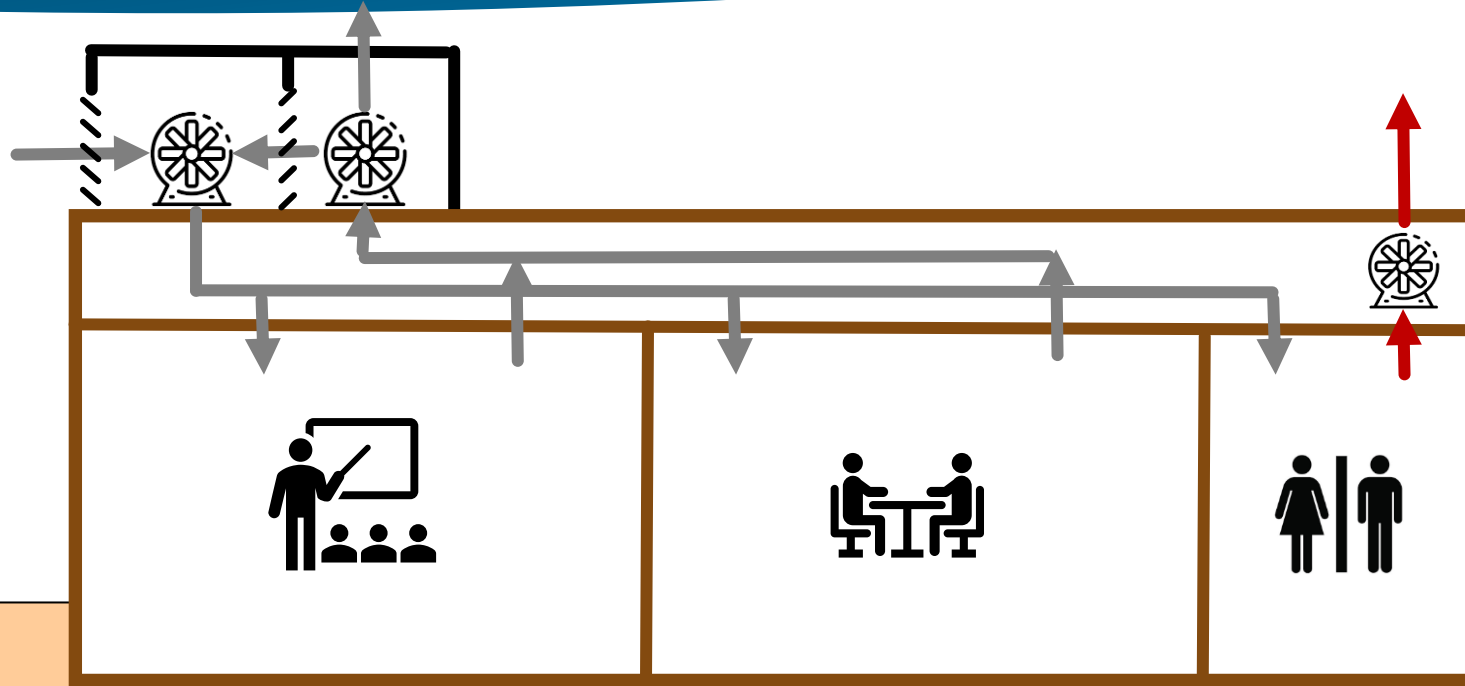

<https://vim-1.itrcweb.org/heating-ventilation-and-air-conditioning-hvac-modification-tech-sheet/>

Source: Sanborn, Head & Associates, 2020. Used with permission.

Coming Up Next...

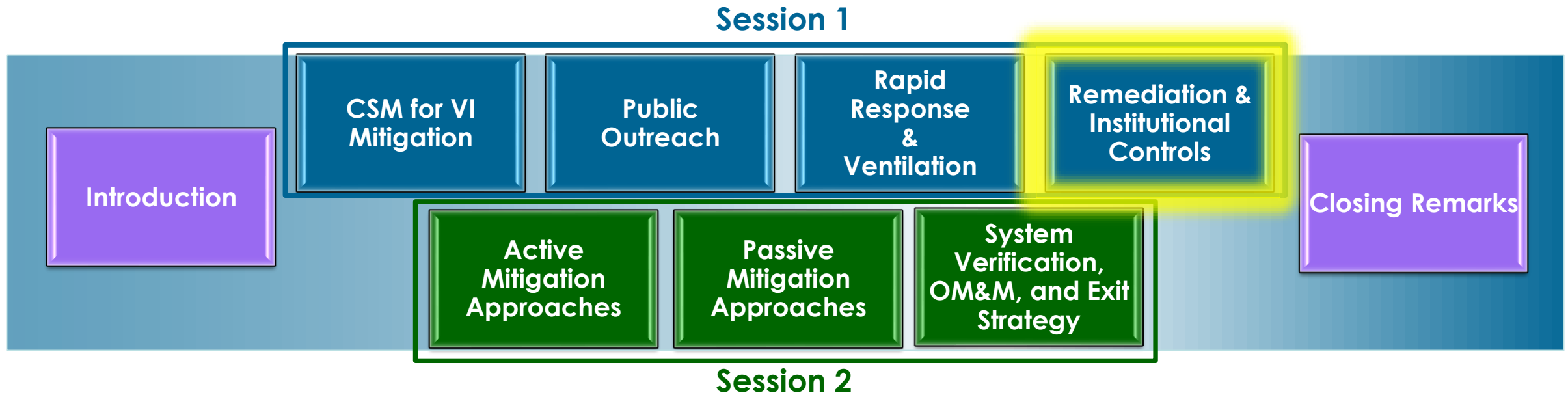



ADVANCED
ENVIRONMENTAL
SOLUTIONS

Environmental Remediation & Institutional Controls

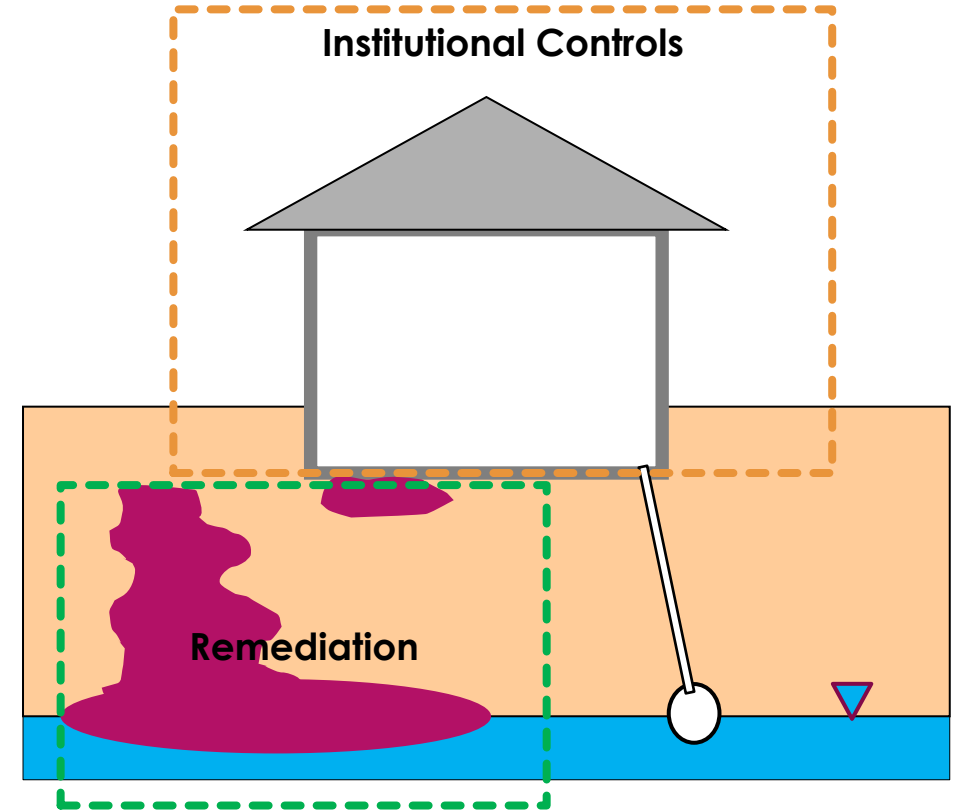

Source: Geosyntec & GSI Environmental, 2020. Used with permission.



ERIS
ENVIRONMENTAL RESEARCH
INSTITUTE OF THE STATES

E C O S

Objectives of Module

- ▶ Difference between remediation and mitigation
- ▶ Description of two soil vapor remediation methods that address vapor intrusion (VI)
- ▶ Introduction to institutional controls (IC)

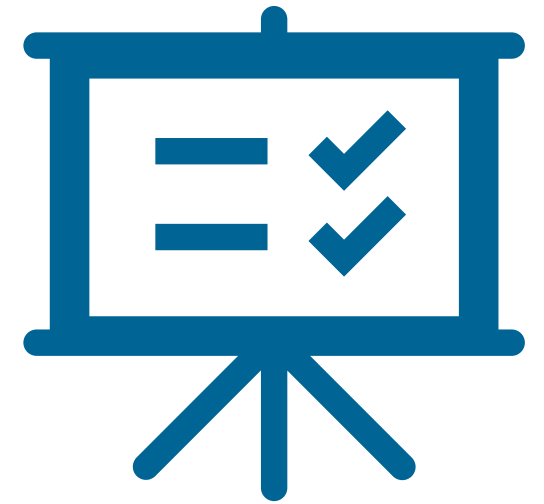

Remediation vs. Mitigation

REMEDIATION

- ▶ Reduce mass in the source medium: soil, groundwater, or free phase
- ▶ Site-wide
- ▶ Longer-term installation, i.e., months

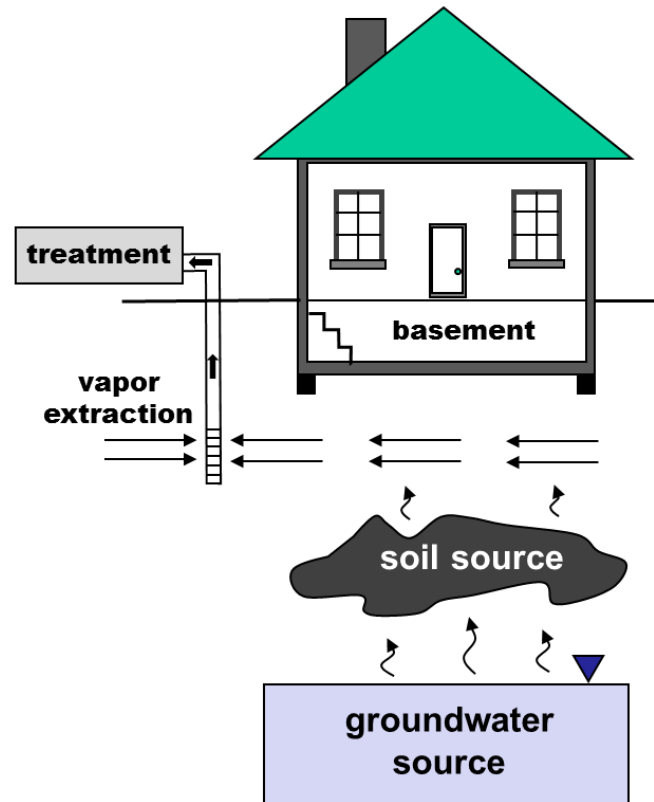

Source: Shell Global Solutions (US) Inc.
Used with permission.

MITIGATION

- ▶ Limit or prevent exposure at some point along the VI pathway
- ▶ Building-specific
- ▶ Shorter-term installation, i.e., weeks
- ▶ May also provide a remediation benefit

Remediation as Mitigation

Remediation Technologies for the Vadose Zone

- ▶ Targeted COCs: Hydrocarbon and chlorinated solvent vapors
 - ▶ Gas/vapor in the vadose zone, and exposure pathway drive the human health risk
 - ▶ Mitigation addresses the pathway, remediation can address both
 - ▶ Applicable remediation technologies: SVE and MPE

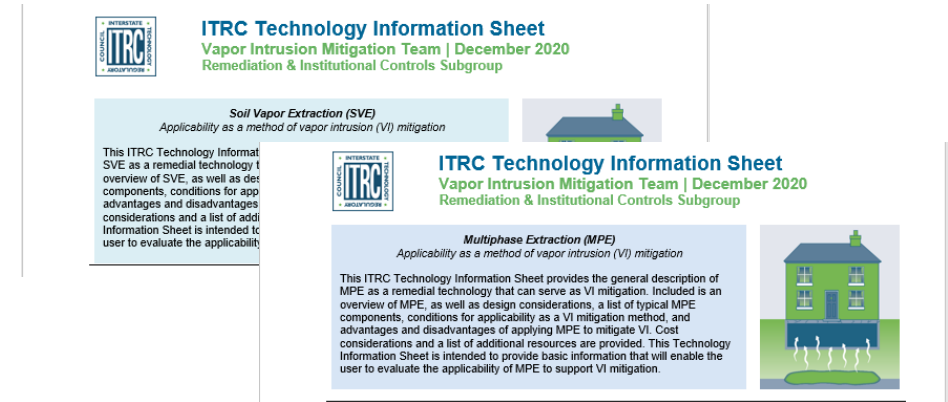

See SVE and MPE Tech Sheets.

<https://vim-1.itrcweb.org/soil-vapor-extraction-sve-tech-sheet/>

<https://vim-1.itrcweb.org/multiphase-extraction-mpe-tech-sheet/>

Tech Sheet – Soil Vapor Extraction (SVE)

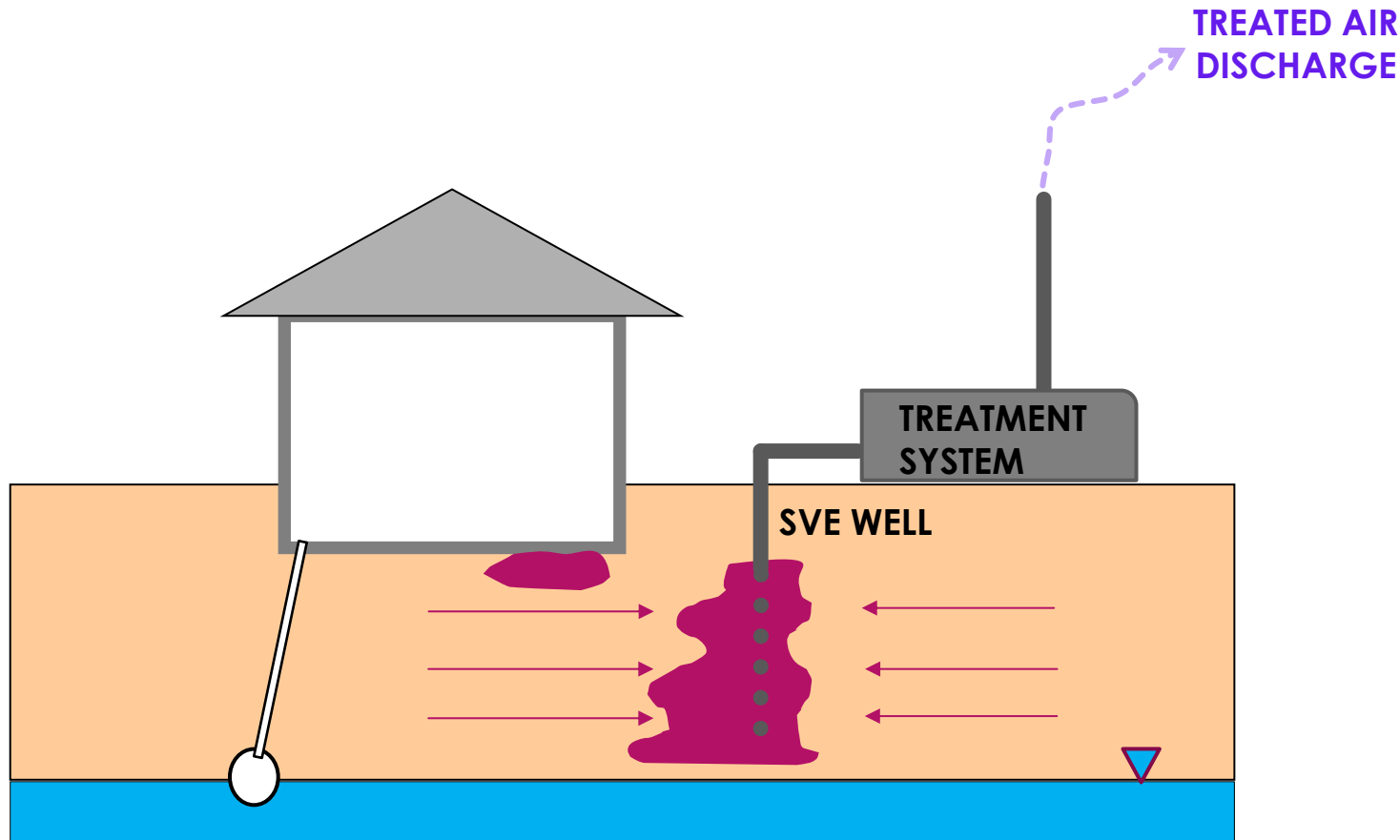
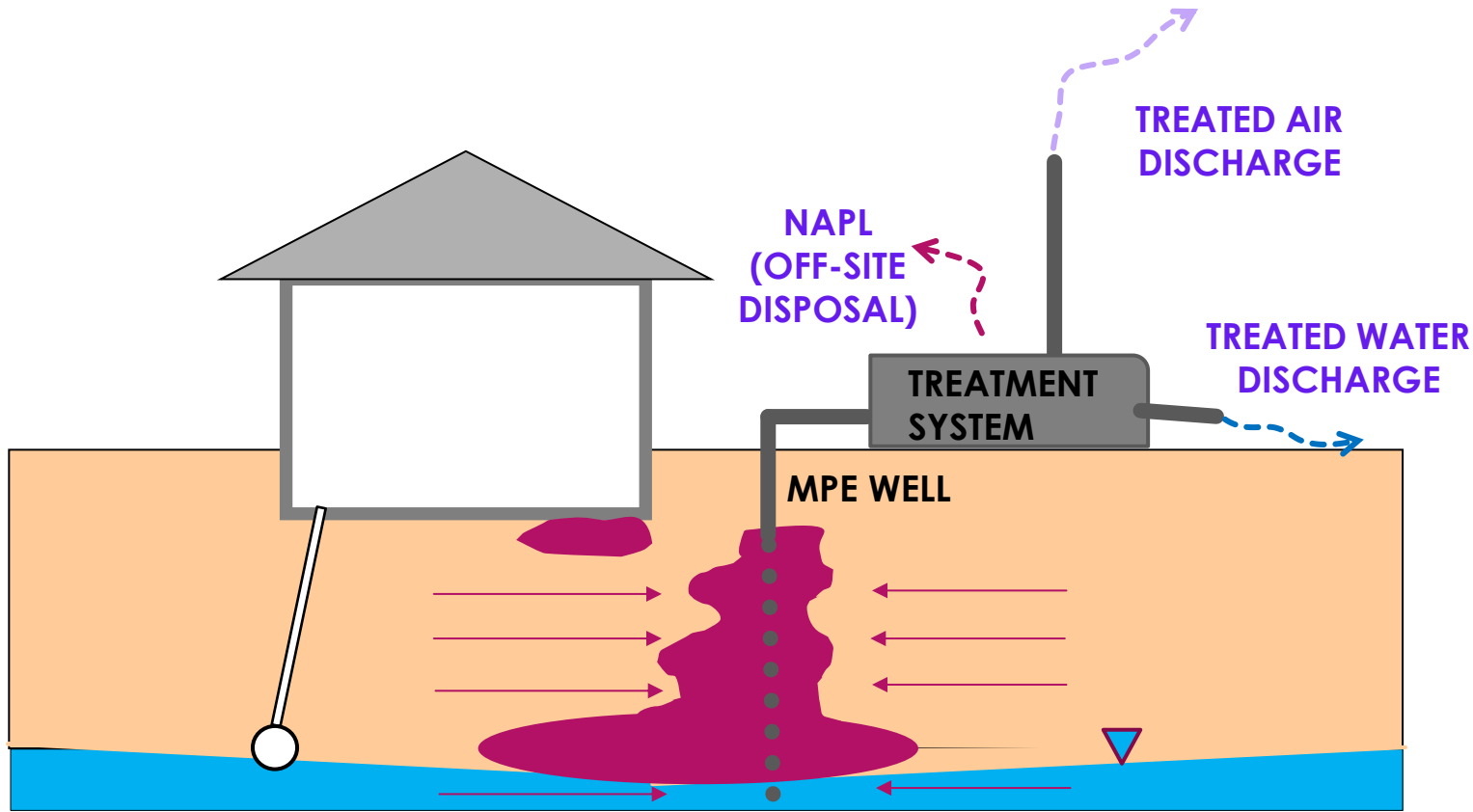

Figure 1 from the ITRC SVE Technology Information Sheet

- ▶ Targets only the vadose zone
- ▶ Intercepts soil vapors
- ▶ Creates sub-surface pressure gradient away from the building slab
- ▶ Performance typically evaluated based on current/planned site use

<https://vim-1.itrcweb.org/soil-vapor-extraction-sve-tech-sheet/>

Tech Sheet – Multi-phase Extraction (MPE)



- ▶ Targets vadose zone *and* saturated zone
- ▶ Intercepts soil vapors and withdraws water/free product (if present)
- ▶ Performance not linked to vadose zone thickness

<https://vim-1.itrcweb.org/multiphase-extraction-mpe-tech-sheet/>

Figure 1 from the ITRC MPE Technology Information Sheet

Poll

Have you been involved with a site that has a deed restriction or land use control as part of VI mitigation strategy; if so, which? (check all that apply)

- A. Construction requirements
- B. Building type
- C. Occupancy
- D. Required active or passive vapor mitigation
- E. Restrictions on groundwater use
- F. Other



Source: Clipartmax.com

Tech Sheet – Institutional Controls (IC)



Source: ITRC Long Term Contaminant Management Using Institutional Controls Guidance

<https://vim-1.itrcweb.org/institutional-controls-ic-tech-sheet/>

- ▶ Long-term measures that provide:
 - ▶ Protection from exposure to contaminants
 - ▶ Assurance that VI mitigation system will be maintained
- ▶ Applied alone or in combination with other remedies

Government controls: Zoning ordinances, groundwater use or drilling limitations, land development regulations, etc.

Proprietary controls: Private agreement between landowner and outside party that “run with the land”

Enforcement mechanisms: Government agency-issued permits, administrative orders, etc.

Informational devices: Provide information about risks from site COCs

Knowledge Check

When might you consider implementing ICs?

- A. Remediated site that includes a passive venting system
- B. Remediated site that includes an active venting system
- C. Potential future land development
- D. All of the above
- E. None of the above



Source: Pixabay

Knowledge Check

When might you consider implementing ICs?

- A. Remediated site that includes a passive venting system
- B. Remediated site that includes an active venting system
- C. Potential future land development
- All of the above
- E. None of the above



Source: Pixabay

Additional ITRC Resources

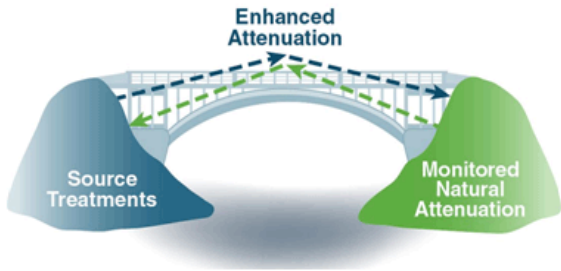

- ▶ “DNAPL Source Reduction: Facing the Challenge” ([DNAPLs-2, 2002](#))
- ▶ “Enhanced Attenuation: Chlorinated Organics” ([EACO-1, 2008](#))
- ▶ “Enhanced In-Situ Bioremediation of Chlorinated Solvents in Groundwater” ([ISB-6, 1998](#))
- ▶ “In-Situ Chemical Oxidation of Contaminated Soil & Groundwater” ([ISCO-2, 2005](#))
- ▶ “Evaluating LNAPL Remedial Technologies for Achieving Project Goals” ([LNAPL-2, 2009](#))
- ▶ “Long Term Management Using Institutional Controls” ([IC-1, 2016](#))

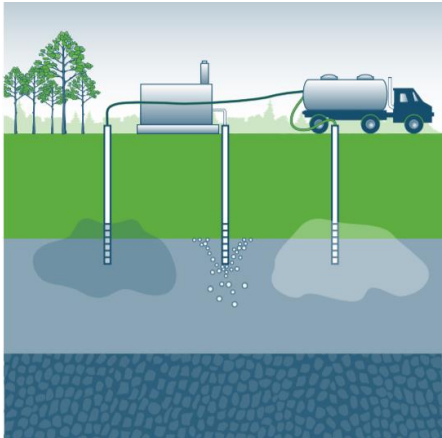

Thank you for attending!

Questions

- ▶ Email further questions on today's session to: training@itrcweb.org
- ▶ Feedback Form & Certificate of Completion: <https://clu-in.org/conf/itrc/VIM-1/feedback.cfm>
- ▶ Vapor Intrusion Mitigation Training: <https://clu-in.org/conf/itrc/vim-1>



Source: Pixabay