

Module 1:

Introduction and REOC Background



Introduction



How To . . .

- ◆ Ask questions
 - » “?” button on CLU-IN page
- ◆ Control slides as presentation proceeds
 - » manually advance slides
- ◆ Review archived sessions
 - » <http://www.clu-in.org/live/archive.cfm>
- ◆ Contact instructors



1-3

When you registered, you were directed to this seminar's specific URL, which is the front page

of today's seminar. The Front Page of the web cast contains a short abstract of today's session.

We have also included pictures and short biosketches of the presenters. Please note the

presenters' email addresses are hotlinked on that page in case you have any questions for one of

them after today's presentation.

For those of you joining us via the phone lines, we request that you put your phone on mute for

the seminar. We will have Q&A sessions at which point you are welcome to take your phone off

mute and ask the question. If you do not have a mute button on your phone, we ask that you take

a moment RIGHT NOW to hit *6 to place your phone on MUTE. When we get to the question

and answer periods you can hit #6 to unmute the phone. This will greatly reduce the background

noises that can disrupt the quality of the audio transmission.

Also, please do not put us on HOLD. Many organizations have hold music or advertisements that

can be very disruptive to the call.

Introduction of Instructors

- ◆ Instructor – Don Lininger, EPA Region 7
 - » On-Scene Coordinator
 - » RSC Coordinator
- ◆ Instructor – Mary Matthews, EPA Region 10
 - » RSC Coordinator
 - » RICT Alternate Chair
- ◆ Sherry Fielding, EPA Headquarters
 - » National RSC Coordinator



1-4

Instructor Note: ***All instructors should introduce themselves. The participants should then introduce themselves using the bulleted items on the slide as a guide.***

Overview of REOC Webinar

- ◆ Objectives
 - » Review important policy
 - » Describe background for establishment of REOCs
 - » Describe set-up and function of REOCs
- ◆ Topics
 - » Module 1: Introduction and Background
 - » Module 2: REOC ABC's
- ◆ REOC Webinar is a prerequisite for “Knowing and Working Within the REOC” at OSC Readiness 2010



1-5

Instructor Note: ***Review the agenda in the workshop manual and the objectives on this slide.***

REOC Background



Acronyms You Should Know

- ◆ NAR – National Approach to Response
- ◆ NIMS – National Incident Management System
- ◆ NRF – National Response Framework
- ◆ ICS – Incident Command System
- ◆ IMT – Incident Management Team
- ◆ IMH – Incident Management Handbook
- ◆ RSC – Response Support Corps
- ◆ REOC – Regional Emergency Operations Center



1-7

Program Development Timeline

1/2003	2/2003 HSPD-5 Management of Domestic Incidents
	6/2003 National Approach to Response
1/2004	3/2004 National Incident Management System
1/2005	12/2004 National Response Plan
1/2006	5/2006 NRP, Notice of Change
1/2007	
1/2008	1/2008 NRF released
	11/2008 EPA Orders 2070 – IMT & 2071 – NAR
1/2009	12/2008 NIMS Revision
	8/2009 EPA Order 2072 – Response Support Corps



EPA ICS Guidance Documents

- ◆ NIMS/ICS Implementation Plan
- ◆ EPA IMT Order 2070
- ◆ Incident Management Handbook
- ◆ Job Aids
- ◆ Training, Certification & Qualification Order
- ◆ EPA Order 2072 – Response Support Corps



NAR – RSC

- ◆ NAR identified establishment of comprehensive roster of EPA employees to assist during INS
- ◆ September 15, 2003, EPA announced the formation of a Response Support Corps (RSC) within each region and at EPA Headquarters
- ◆ RSC intended to augment the Agency's emergency response capacity
- ◆ RSC provides critical support ranging from telephone duty in the emergency operations centers to direct field work



1-10

Development of RSC Program

- ◆ Development of Core RSC Program and national guidelines
- ◆ Development of a national database of RSC skills/qualifications
- ◆ Establishment of monthly coordination calls and annual meeting of Regional RSC Coordinators



1-11

RSC Coordinators

- ◆ National – Sherry Fielding (202) 564-6174
- ◆ Region 1 – Chris Diehl (617) 918-1941
- ◆ Region 2 – Carl Pellegrino (732) 321-6794
- ◆ Region 3 – Felicia Fred (215) 814-5524
- ◆ Region 4 – Debbie Vaughn-Wright
(404) 562-8538
- ◆ Region 5 – Tom Geishecker (312) 866-0755



(continued)

1-12

RSC Coordinators

- ◆ Region 6 – Susan Webster (214) 665-6764
- ◆ Region 7 – Don Lininger (913) 551-7724
- ◆ Region 8 – Deirdre Rothery (303) 312-6431
- ◆ Region 9 – John Kennedy (415) 947-4128
- ◆ Region 10 – Mary Matthews (206) 553-0249



1-13

FY09 Core NAR – 10 Core Elements

- ◆ 1: Incident Notification and Mobilization
- ◆ 2: EPA Regional and National Assets
- ◆ 3: Professional Development, Training and Exercises
- ◆ 4: Health and Safety
- ◆ 5: Public Information and Community Involvement
- ◆ 6: External Response Coordination
- ◆ 7: Field Capabilities
- ◆ 8: Site Information and Data Management
- ◆ 9: Regional Emergency Operations Center Logistics
- ◆ 10: Acquisition Management



1-14

FY09 Core NAR Element 9: REOC Logistics

- ◆ Standard: The REOC is immediately available, fully equipped and configured for support of daily operations and Incidents of Regional and National Significance
- ◆ Element 9 criteria
 - » 9.1 REOC managed by ER and Removal program and has dedicated call center
 - » 9.2 Region has Top Secret Security Room with communications equipment
 - » 9.3 REOC has workspace, communications, AV/IT for routine to catastrophic events
 - » 9.4 REOC has quick start guides and trouble shooting tips for communication equipment



(continued)

1-15

FY09 Core NAR Element 9: REOC Logistics

◆ Element 9 criteria

- » 9.5 Required communication/AV/IT equipment tested at regular intervals
- » 9.6 Regional staff or contractors available 24/7 to support IT and communication equipment
- » 9.7 Region has 24/7 access to work stations/ printers w/GIS capabilities and staff to support
- » 9.8 Region has access to electronic and hardcopy maps of Region and backup Regions
- » 9.9 Region maintains/updates contact lists quarterly
- » 9.10 Region has electronic and hardcopy versions of references to support responders

(continued)



1-16

FY09 Core NAR Element 9: REOC Logistics

- ◆ Element 9 Criteria
 - » 9.11 Region can model air dispersion (IMAAC)
 - » 9.12 Region has plan for REOC and Alternate REOC that includes 24/7 Security, Access, and Systems Control
 - » 9.13 Region has REOC staffing plan
 - » 9.14 Alternate REOC has functionalities of primary REOC
 - » 9.15 Region has plan for transferring ops from primary to alternate REOC
 - » 9.16 Region has at least 1 REOC-involved exercise per year
 - » 9.17 Region has at least 1 alternative REOC-involved exercise per year



1-17

Regional Incident Coordinator (RIC)

- ◆ Serves as the primary point of contact with IC
- ◆ Provides strategic/management objectives and oversight to the IC
- ◆ Provides clarification of regional policy issues
- ◆ Ensures effective and timely communication flow between field activities and upper level management



1-18

EPA HQ Regional and Field Organizational Chart

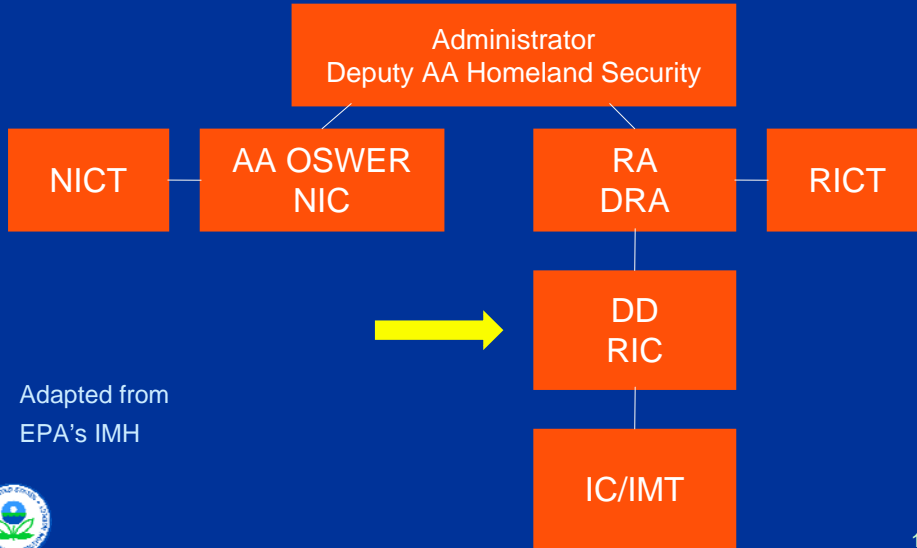

REOC National Guidance Outline

- I. Purpose
- II. Roles and Responsibilities
- III. Background
- IV. Purpose of REOC
- V. REOC Facility Elements
- VI. Staffing and Activation of REOC
 - A. Levels of activation
 - B. Activation of RSC in support of REOC
- VII. Span of Control/REOC Position Terminology
- VIII. Regional Alert System
- IX. Training and Exercises



1-20

Regional REOC Guides

- ◆ Each Region is responsible for developing specific guidelines for its REOC
- ◆ These Region-specific guides have different titles but they accomplish the same thing
 - » For example
 - Region 7 – Concept of Operations
 - Region 10 – Standard Operating Guidelines



1-21

Q&A

Questions?



1-22

Module 2:
REOC ABC's



2-1

Module Content

- ◆ REOC Set Up
- ◆ REOC Functional Definitions
 - » NIMS
 - » NRF
 - » IMH
 - » Core NAR



(continued)

2-2

Module Content

- ◆ REOC
 - » ICS Organization
 - » KLPs
 - » R7 and R10 Example Organizational Charts
- ◆ HQ EOC
 - » ICS Organization
 - » General Role
 - » Watch Officer
 - » EOC Reports
 - » EOC Relationship to REOC



(continued)

2-3

Module Content

- ◆ Characteristic features of the REOC
- ◆ What does the REOC produce?
- ◆ REOC position-specific email boxes
- ◆ Types of REOC activations



2-4

Region 3 REOC



2-5

Region 5 REOC

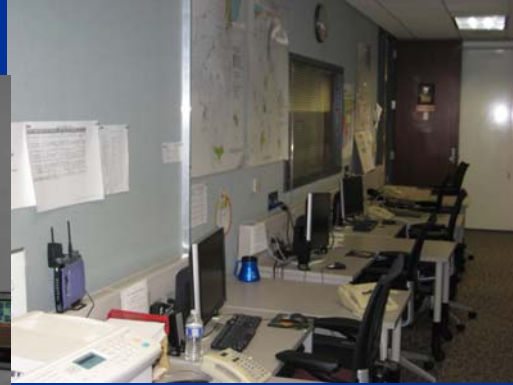

2-6

Region 7 REOC



2-7

Region 8 REOC



2-8

Region 8 REOC Set Up

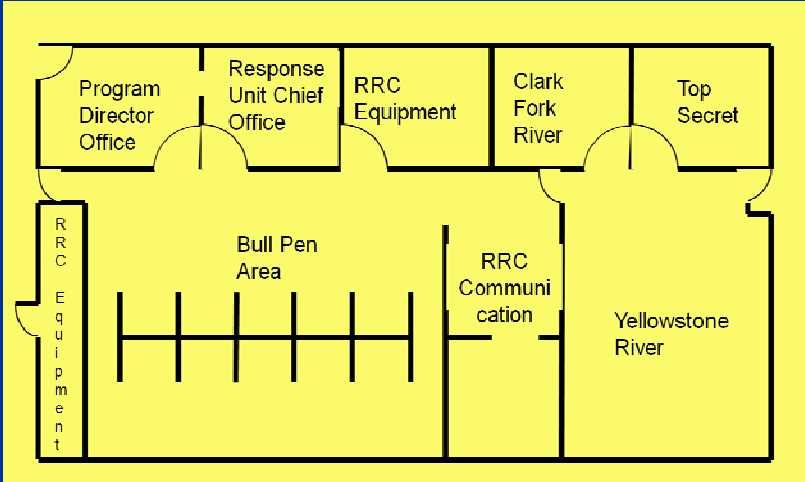

Region 10 REOC



2-10

Region 10 REOC Set Up

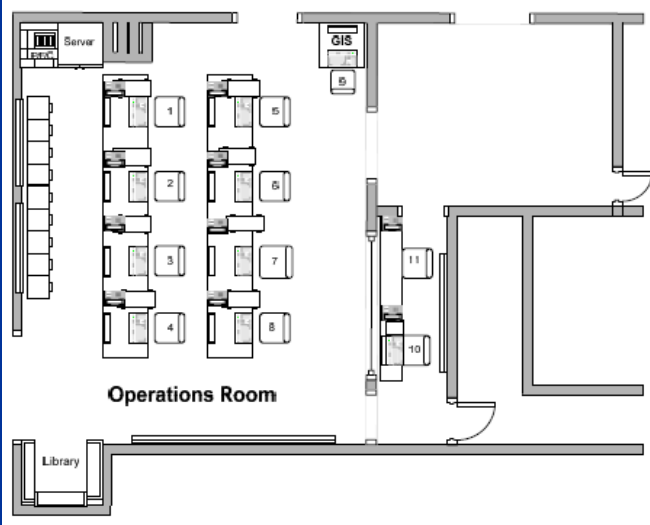

2-11

HQ EOC Set Up

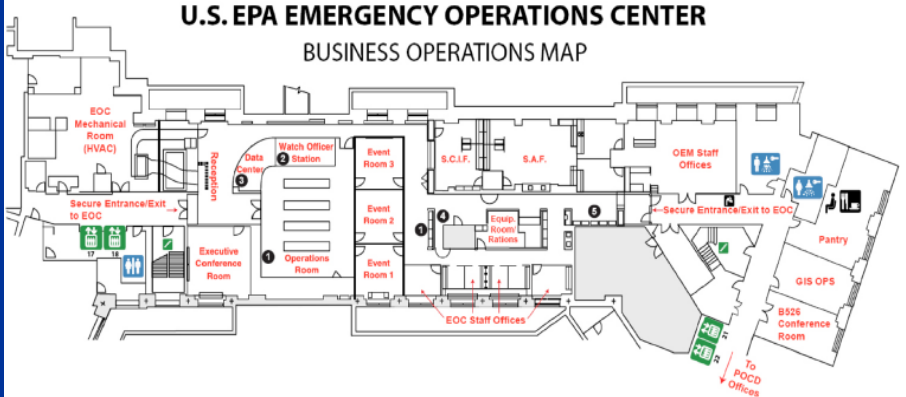

2-12

HQ EOC



2-13

REOC Definition

- ◆ REOC defined based on function
 - » NIMS definition
 - » NRF definition
 - » IMH definition
 - » Core NAR requirement



2-14

NIMS Definition of EOC

- ◆ Emergency Operations Centers
 - » Physical location to support on-scene operations
 - » Temporary or permanent
 - » Organized by functional disciplines, jurisdiction, or combination



2-15

NRF Definition of EOC

- ◆ EOC functions
 - » Common operational picture
 - » Relieves Burden of External Coordination
 - » Secures/Allocates Resources



2-16

IMH Definition of EOC

- ◆ Focus on functions
 - » Activation for effective support of an incident
 - » “Reach back” support
 - » Information conduit
 - » Assign resources and coordinate activities



2-17

Core NAR Requirements for REOC – Element 9

- ◆ Core NAR Standard
 - » Immediately available
 - » Fully equipped
 - » Manages small and large incidents
- ◆ 17 criteria for Element 9
- ◆ Annual Regional audit



2-18

REOC Uses Standard ICS Structure

Standard ICS Structure

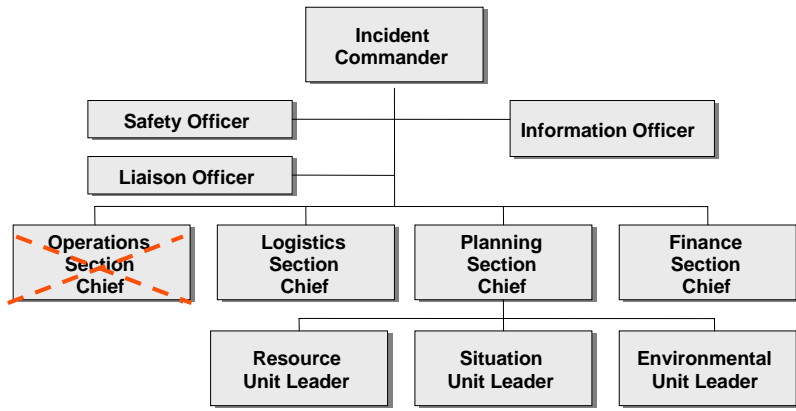

2-19

Key Leadership Positions and RSC Role in Filling Them

Standard ICS Structure

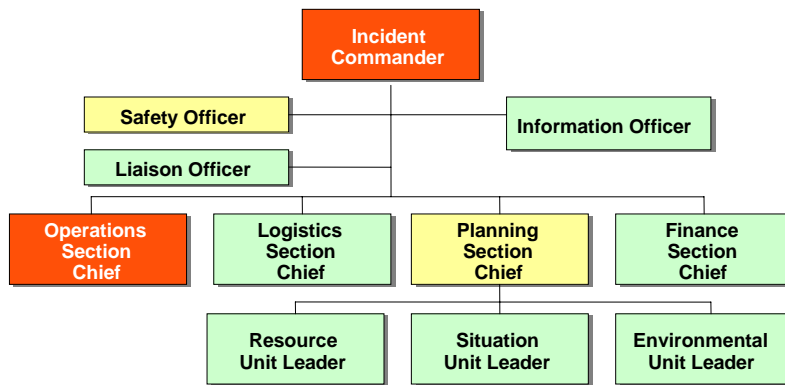

2-20

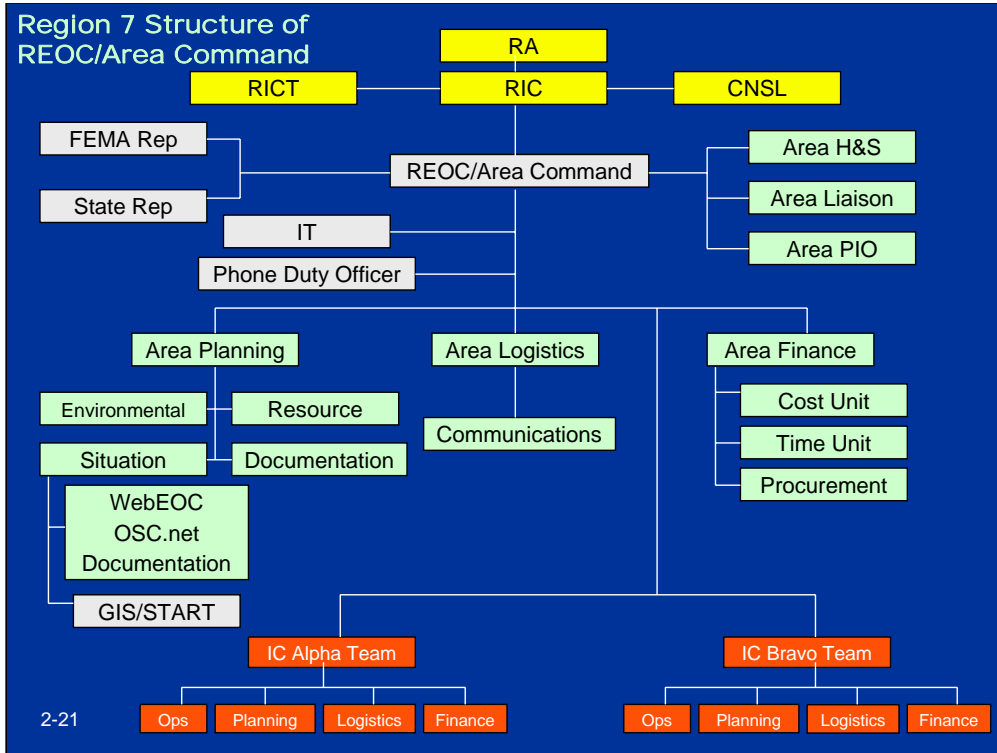

Region 10 REOC Organization

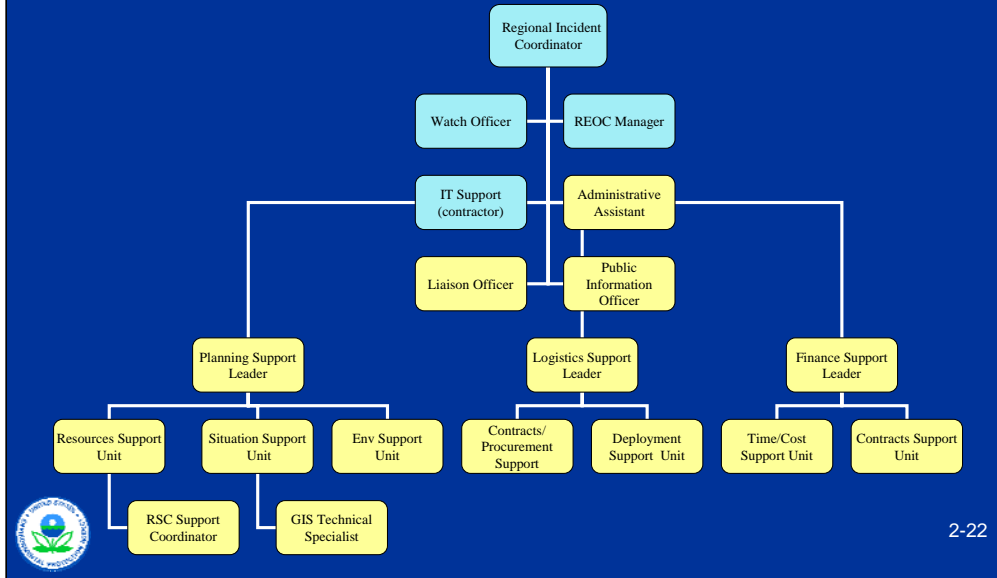

2-22

How is HQ EOC Organized Differently From REOC?

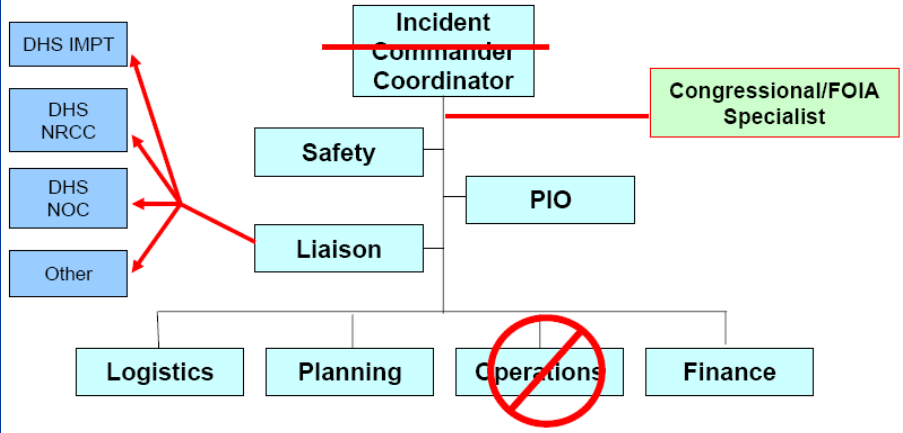

What is the Role of the HQ EOC?

- ◆ National level information hub
- ◆ Provides support to REOCs
- ◆ 24/7 Watch Officer
- ◆ Classified information



2-24

What is the Role of the HQ EOC Watch Officer?

- ◆ Maintains situational awareness
- ◆ Internal notifications
- ◆ Coordinates with DHS
- ◆ Receives and disseminates emergency alerts and warnings



2-25

HQ Model for National Incident Management



Level of Coordination	Organizational Structure	Organizational Position	Roles & Responsibilities
National Coordination	HQ Emergency Operations Center (EOC)	National Incident Coordinator (NIC)	Provides Strategic Objectives Communicates with the RIC and REOC Provides cross-program support
Regional Coordination	Regional Emergency Operations Center (REOC)	Regional Incident Coordinator (RIC)	Provides Management Objectives & cross-program support Communicates with IC and supports field ops
Tactical Coordination	Incident Management Team	Incident Commander	Operational Decision Making



2-26

Characteristic Features of the REOC

- ◆ Managed by Regional EPA ER organization
- ◆ Phone duty officer
- ◆ 24/7/365 availability
- ◆ Eating and sleeping provisions
- ◆ Modular work stations fully equipped
- ◆ Top Secret Security Room
- ◆ Nearby conference rooms
- ◆ News and weather feeds



(continued) 2-27

Characteristic Features of the REOC

- ◆ Communications
 - » Conventional telecom (hardwire and cell)
 - » Satellite phones
 - » VOIP
 - » HF radio
 - » Video conference capabilities
- ◆ Large screens
- ◆ Quick guides
- ◆ IT support
- ◆ GIS support



2-28

What Does the REOC Produce?

- ◆ What are POLREPs and SITREPs?
- ◆ POLREP/SITREP Guidance
 - » OSWER Directive 9360.3-03, “Guidance for Preparing POLREPS/SITREPS,” December 2007
 - » Memorandum, “Availability of the New POLREP/SITREP Format and Measures Fields on EPAOSC website,” September 22, 2008
- ◆ POLREPs required by NCP



2-29

What Does the REOC Produce – POLREPs

- ◆ “Owned” by OSC
- ◆ Document source and circumstances of the release
- ◆ Identify PRPs
- ◆ Describe removal activities performed
- ◆ Account for costs incurred
- ◆ Describe impact of the release



(continued) 2-30

What Does the REOC Produce – POLREPs

- ◆ Emergency, time-critical, and non-time-critical actions
- ◆ CERCLA and OPA responses
- ◆ New program measures
 - » Human exposure avoided/\$1M
 - » Acreage protective for people at ERs and removal sites
- ◆ Template at www.epaosc.net
- ◆ Initial and Final POLREP significance



2-31

What Does the REOC Produce – SITREPs

- ◆ Stafford Act/Incident of National Significance response
- ◆ Created by Situation Unit Leader
- ◆ Field report for each operational period
- ◆ Incident status
- ◆ Template on WebEOC



2-32

What Does the REOC Produce?

- ◆ Graphics
- ◆ Data tables and graphs
- ◆ Briefing documents
- ◆ EOC Action Plans



2-33

REOC Position-Specific Email Boxes

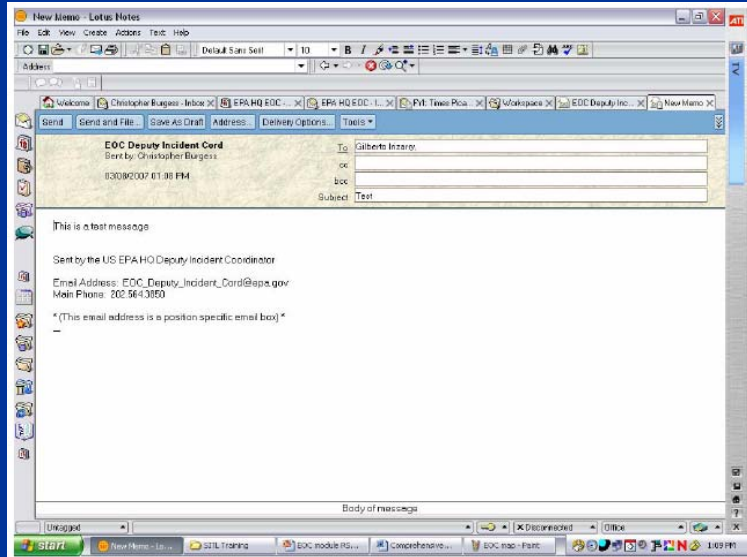

2-34



What Are the Various Types of REOC Activations?

- ◆ Routine
- ◆ Exercises
- ◆ Incident specific activation
 - » Flexible, scalable, and modular
 - » Activation scale defined in REOC SOP
 - » REOC SOPs



2-35

Questions?



2-36

FINAL INSTRUCTIONS FOR COMPLETING EVALUATION



2-37

Thank You

After viewing the links to additional resources,
please complete our online feedback form.



Thank You

[Links to Additional Resources](#)

[Feedback Form](#)



2-38