

# IN SITU THERMAL DESORPTION OF COAL TAR

Kirk S. Hansen and Denis M. Conley  
TerraTherm Environmental Services Inc.,

Harold J. Vinegar, John M. Coles, and James L. Menotti  
Shell Exploration & Production Technology Company

George L. Stegemeier  
GLS Engineering, Inc.

## ABSTRACT

In Situ Thermal Desorption (ISTD) is a soil remediation process in which heat and vacuum are applied simultaneously to subsurface soils. Depending on the depth of treatment, an array of either thermal blankets or vacuum/heater wells is used. Produced vapors are treated with an air pollution control (APC) system to remove residual contaminants that have not been destroyed *in situ*. ISTD has been applied previously for remediation of soils containing PCBs having boiling points of 350°C to 400°C. In order to extend this technology to treatment of Manufactured Gas Plant (MGP) waste, which potentially requires even higher treatment temperatures to remove polyaromatic hydrocarbons (PAHs), a series of treatability tests was carried out on samples of coal tar and contaminated soil from various MGP sites. Larger-scale heating experiments were also performed at a field test facility to remove tar from soil contained in a drum. These experiments were conducted to optimize thermal well designs for remediation of coal tar while minimizing the potential for coking.

In treatability samples, concentrations of benzene were reduced by a factor of over 1000 after as little as 1 day of heating at 200°C. Treatment at higher temperatures or for longer periods of time at the same temperature progressively reduced the PAH concentrations to very low residual levels. Three days of treatment at 300°C provided even better results than one day at 400°C, illustrating the beneficial results of the extended treatment times (days to weeks) that can be achieved with ISTD in the field. Results from the tar-drum experiments indicate that all of the contaminants from the tar in a mixed tar/soil layer were removed and that most of the tar was oxidized to CO<sub>2</sub> and H<sub>2</sub>O. These laboratory treatability studies and field tar-drum experiments show that, with proper well designs, the ISTD process can be used safely and effectively for remediating all organic components of MGP waste, including the carcinogenic PAHs.

# IN SITU THERMAL DESORPTION OF COAL TAR

## INTRODUCTION

In Situ Thermal Desorption (ISTD) is a remediation process in which heat and vacuum are applied simultaneously to subsurface soils. ISTD is remarkably versatile and effective. It can remediate virtually all organic contaminants, including Manufactured Gas Plant (MGP) waste such as coal tar, which typically contains polyaromatic hydrocarbons (PAHs) plus benzene and other volatiles. Additional targeted compounds for ISTD include chlorinated solvents, polychlorinated biphenyls (PCBs), pesticides, and dioxins.

Depending on the required depth of treatment, heat is typically applied to the soil using an array of thermal blankets [1-3] or heater/vacuum wells placed vertically in the ground in triangular patterns [4]. The blankets or wells are equipped with high-temperature electric heaters (1650°F, ~900°C) and connected to a vacuum blower. As heat is injected and soil temperatures rise, the vaporized products are drawn towards the blankets or wells by the applied vacuum and are mostly destroyed *in situ* as they pass through the hottest soil and over the heaters within the blankets and wells themselves. Produced vapors are treated in an air pollution control (APC) system to remove residual contaminants that have not been destroyed *in situ*.

Unlike fluid injection processes, ISTD is applicable to tight soils such as silt or clay layers [5], and to heterogeneous soils with wide variations in permeability and water content. The ISTD process possesses a high removal efficiency because the narrow range of soil thermal conductivities provides excellent sweep efficiency and because its very long residence time at high operating temperatures assures complete displacement efficiency. Figure 1 shows the time-temperature history at depth for a typical ISTD well demonstration to remove PCBs at the Missouri Electric Works Superfund site in Cape Girardeau, Missouri [5]. Initially, soil temperatures rise to the boiling point of water and level off at 212°F (100°C). The duration of the boiling phase is dependent on the pore water content and water inflow, and typically lasts for a few weeks. Subsequently, in the “superheating” phase, temperatures rise rapidly to the desired treatment temperature. For Cape Girardeau, maximum temperatures over 900°F (~480°C) were reached at the coldest spots in the centroids of heater well triangles, and about 50% of the treated soil volume was over 1100°F (~590°C) by the end of the heating cycle. Even the coldest spots exceeded 600°F (~320°C) for at least 228 hours. This remarkable combination of high temperatures and very long residence times enables the ISTD process to achieve exceptionally low levels of residual organic contamination.

ISTD is thus well suited for remediation of MGP sites, of which over 3,000 are estimated to exist in North America and over 7,000 worldwide. Manufactured gas plants were typically located on waterways within towns and cities. Today, the contaminated soil in these former MGP sites often underlies valuable commercial or residential real estate. Many sites continue to pose environmental hazards for groundwater and surface water. If excavated for remediation or construction, they expose workers and nearby residents to odiferous and potentially toxic vapors. In contrast, ISTD is a clean, odorless process that can be used without disrupting residential neighborhoods or ongoing commercial activities on site. Because the soil is not disturbed, there is minimal exposure to workers and the public. ISTD can also be applied underneath buildings and below the water table.

In order to extend ISTD technology to treatment of MGP waste, a series of treatability tests was performed on samples of coal tar and contaminated soil from various MGP sites. Treatment temperatures approaching the boiling point of benzo(a)pyrene (925°F = 496°C) are potentially required. Larger-scale tar-drum experiments to remove tar from soil in a controlled setting were also performed at Shell's

Gasmer Road test facility in Houston, Texas. These experiments were conducted to optimize thermal well designs for remediation of coal tar and to investigate other issues including pressure buildup due to low permeability in the tar-saturated soil, tar migration into clean areas during heating, surface subsidence, and design of offgas treatment equipment.

### Soil Temperature History at 6 Feet Depth

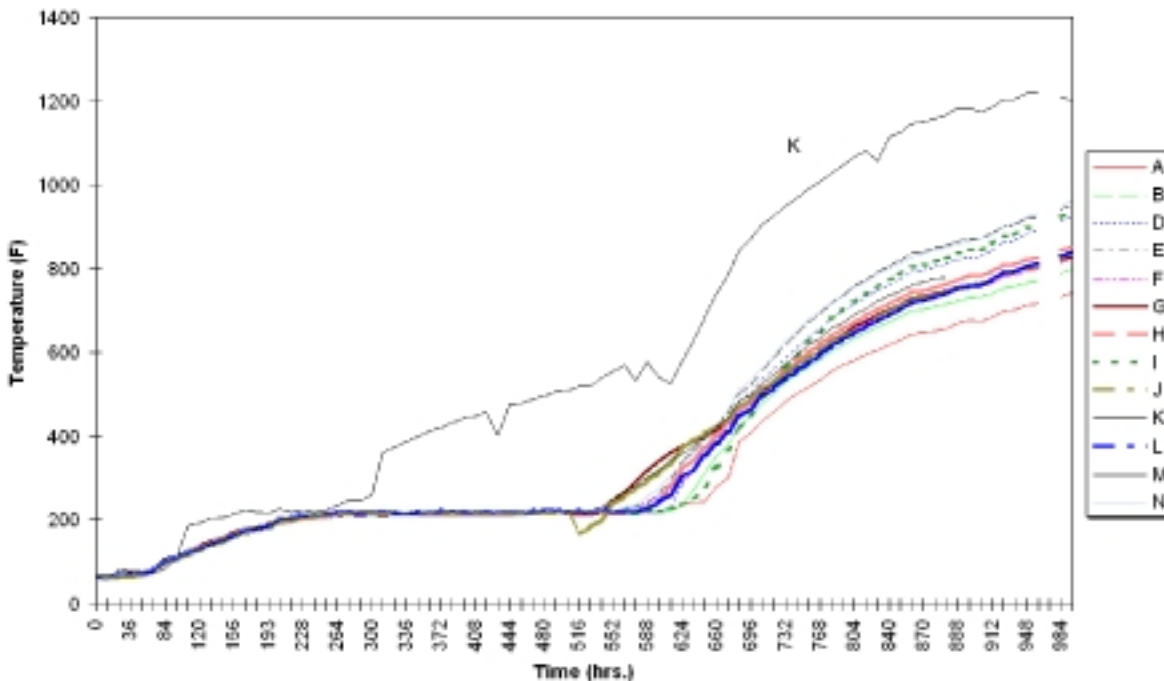

Figure 1. Soil temperatures from ISTD thermal well project at Cape Girardeau, Missouri. Depicted temperatures are at a depth of 6 feet for coolest spots between wells, except for curve K, which represents the median soil temperature at the end of heating.

### TREATABILITY STUDIES

Samples of coal tar or contaminated soil were obtained from three MGP sites for thermal treatability studies in the laboratory. The objective of the treatability tests was to determine the temperature and the time at elevated temperature required to reduce the MGP contaminants to very low residual levels. Nearly pure coal tar from MGP Site No. 1 had total concentrations of benzene, toluene, ethylbenzene, and xylene (BTEX) equal to 619 mg/kg and of PAHs greater than 57,700 mg/kg (Table 1). A mixture of coal-tar sludge and silty soil from Site No. 2 exhibited BTEX levels of 39 mg/kg and PAH concentrations of nearly 1,400 mg/kg. A silty sand from MGP Site No. 3 was less contaminated, having total PAH concentrations of 844 mg/kg.

### Test Procedures

The treatability tests were carried out by placing 50-100 g of each sample in uncovered crucibles and heating them in an EN-149 muffle oven at the temperatures and times indicated in Table 1. The treatment temperatures were chosen based on the boiling points of the primary constituents of concern

Table 1. Soil Analyses from Thermal Treatability Studies on MGP Samples

Constituent	MGP Site No. 1 (-----)					MGP Site No. 2 (Missouri)				MGP Site No. 3 (California)		Units
	Initial Coal Tar	1 Day at 200°C	1 Day at 300°C	1 Day at 400°C	3 Days at 300°C	Initial Sludge/Silt	1 Day at 200°C	1 Day at 300°C	3 Days at 300°C	Initial Silty Sand	1 Day at 350°C	
Volatile Organic Compounds												
	EPA Method 5030/8020					EPA Method 8240B						
Benzene	140,000	NA	NA	NA	NA	39,000	22	14	10	NA	NA	µg/kg
Toluene	180,000	NA	NA	NA	NA	NA	NA	NA	NA	NA	NA	µg/kg
Ethylbenzene	19,000	NA	NA	NA	NA	NA	NA	NA	NA	NA	NA	µg/kg
Total Xylenes	280,000	NA	NA	NA	NA	NA	NA	NA	NA	NA	NA	µg/kg
Detectable BTEX	619,000					39,000	22	14	10			µg/kg
Semivolatile Organic Compounds												
	EPA Method 8310 (Polycyclic Aromatic Hydrocarbons)					EPA Method 8270 (Semivolatile Organics)				EPA Method 8310		
Naphthalene	18,000,000	<33,000	<660	<33	<16.5	360,000	<330	<400	NA	230,000	7	µg/kg
1-Methylnaphthalene	2,700,000	<33,000	<660	<66	<33	NA	NA	NA	NA	51,000	<3.3	µg/kg
2-Methylnaphthalene	8,000,000	140,000	810	<66	<33	180,000	<330	<400	NA	100,000	<6.6	µg/kg
Acenaphthylene	1,300,000	<33,000	<660	<33	<16.5	94,000	<330	<400	NA	17,000	<3.3	µg/kg
Acenaphthene	750,000	<33,000	<1,660	<33	<41.5	14,000	<330	<400	NA	23,000	<8.3	µg/kg
Fluorene	3,200,000	<33,000	<1,660	<33	<41.5	75,000	<330	<400	NA	28,000	<8.3	µg/kg
Phenanthrene	7,600,000	970,000	19,000	<33	<16.5	230,000	<330	<400	NA	120,000	<3.3	µg/kg
Anthracene	2,100,000	210,000	<660	<33	<16.5	67,000	<330	<400	NA	29,000	<3.3	µg/kg
Fluoranthene	4,500,000	690,000	43,000	91	43	93,000	<330	<400	NA	63,000	<3.3	µg/kg
Pyrene	3,700,000	510,000	35,000	160	46	110,000	<330	<400	NA	76,000	<3.3	µg/kg
Benzo(a)anthracene*	1,000,000	140,000	9,200	130	25	35,000	<330	<400	NA	36,000	<3.3	µg/kg
Chrysene*	1,300,000	150,000	13,000	200	32	35,000	450	<400	NA	33,000	<3.3	µg/kg
Benzo(b)fluoranthene*	960,000	180,000	14,000	410	54	13,000	<330	<400	NA	17,000	<3.3	µg/kg
Benzo(k)fluoranthene*	390,000	46,000	5,600	140	20	21,000	<330	<400	NA	<3,300	<3.3	µg/kg
Benzo(a)pyrene*	1,100,000	98,000	5,900	360	37	31,000	<330	<400	NA	21,000	<3.3	µg/kg
Benzo(g,h,i)perylene	690,000	66,000	6,400	570	41	14,000	<330	<400	NA	<3,300	<3.3	µg/kg
Indeno(1,2,3-cd)pyrene*	400,000	33,000	900	380	71	11,000	<330	<400	NA	<3,300	<3.3	µg/kg
Dibenzo(a,h)anthracene*	44,000	<33,000	2,500	<33	<16.5	<6600	<330	<400	NA	<3,300	<3.3	µg/kg
Dibenzofuran	NA	NA	NA	NA	NA	15,000	<330	<400	NA	NA	<6.6	µg/kg
Detectable SVOCs	57,734,000	3,233,000	155,310	2,441	369	1,398,000	450			844,000	7	µg/kg
Total Petroleum Hydrocarbons (EPA Method 418.1 Modified)												
TPH	NA	NA	NA	NA	NA	NA	NA	NA	NA	430	NA	mg/kg
Total Organic Carbon (Soil Leachable, EPA Method 415.1 Modified)												
Soil Leachable Carbon	NA	NA	NA	NA	NA	NA	NA	NA	NA	190	NA	mg/kg

\*Carcinogenic [6].  
NA - not analyzed.

(Table 2). Temperatures of 200°C and 300°C were used for samples from MGP Site No. 2, where elimination of low-boiling BTEX was the main remedial objective. Higher treatment temperatures of up to 400°C were used for samples from the other two sites, where high-boiling carcinogenic PAHs such as chrysene and benzo(a)pyrene [6] are the primary constituents of interest. The temperatures were ramped up slowly (0.8 C°/min) over a period of several hours to avoid splattering of the samples, and then held constant at the desired treatment temperature for an additional 24 or 72 hours.

Table 2. Basic Properties and Derived Quantities from Treatability Tests

Constituent	Molecular Formula	Molecular Weight	Boiling Point (°C)	Residuals C/C <sub>0</sub> **		Decay Constants at 300°C	
				1 day at 400°C	3 days at 300°C	k <sub>i</sub> (day <sup>-1</sup> )	k <sub>f</sub> (day <sup>-1</sup> )
Volatile Organic Compounds							
Benzene	C <sub>6</sub> H <sub>6</sub>	78	80	..	2.6 x 10 <sup>-4</sup>	..	..
Toluene	C <sub>7</sub> H <sub>8</sub>	92	111	..	..	..	..
Ethylbenzene	C <sub>8</sub> H <sub>10</sub>	106	136	..	..	..	..
Xylenes	C <sub>8</sub> H <sub>10</sub>	106	138-144	..	..	..	..
Semivolatile Organic Compounds							
Naphthalene	C <sub>10</sub> H <sub>8</sub>	128	218	<1.8 x 10 <sup>-6</sup>	<9.2 x 10 <sup>-7</sup>	..	..
1-Methylnaphthalene	C <sub>11</sub> H <sub>10</sub>	142	241	<2.4 x 10 <sup>-5</sup>	<1.2 x 10 <sup>-5</sup>	..	..
2-Methylnaphthalene	C <sub>11</sub> H <sub>10</sub>	142	241	<8.3 x 10 <sup>-6</sup>	<4.1 x 10 <sup>-6</sup>	..	..
Acenaphthylene	C <sub>12</sub> H <sub>8</sub>	152	~270	<2.5 x 10 <sup>-5</sup>	<1.3 x 10 <sup>-5</sup>	..	..
Acenaphthene	C <sub>12</sub> H <sub>10</sub>	154	278	<4.4 x 10 <sup>-5</sup>	<5.5 x 10 <sup>-5</sup>	..	..
Fluorene	C <sub>13</sub> H <sub>10</sub>	166	294	<1.0 x 10 <sup>-5</sup>	<1.3 x 10 <sup>-5</sup>	..	..
Phenanthrene	C <sub>14</sub> H <sub>10</sub>	178	340	<4.3 x 10 <sup>-6</sup>	<2.2 x 10 <sup>-6</sup>	..	..
Anthracene	C <sub>14</sub> H <sub>10</sub>	178	340	<1.6 x 10 <sup>-5</sup>	<7.9 x 10 <sup>-6</sup>	..	..
Fluoranthene	C <sub>16</sub> H <sub>10</sub>	202	393	2.0 x 10 <sup>-5</sup>	9.6 x 10 <sup>-6</sup>	4.7	3.5
Pyrene	C <sub>16</sub> H <sub>10</sub>	202	394	4.3 x 10 <sup>-5</sup>	1.2 x 10 <sup>-5</sup>	4.7	3.3
Benzo(a)anthracene*	C <sub>18</sub> H <sub>12</sub>	228	400	1.3 x 10 <sup>-4</sup>	2.5 x 10 <sup>-5</sup>	4.7	3.0
Chrysene*	C <sub>18</sub> H <sub>12</sub>	228	448	1.5 x 10 <sup>-4</sup>	2.5 x 10 <sup>-5</sup>	4.6	3.0
Benzo(b)fluoranthene*	C <sub>20</sub> H <sub>12</sub>	252	481	4.3 x 10 <sup>-4</sup>	5.6 x 10 <sup>-5</sup>	4.2	3.0
Benzo(k)fluoranthene*	C <sub>20</sub> H <sub>12</sub>	252	480	3.6 x 10 <sup>-4</sup>	5.1 x 10 <sup>-5</sup>	4.2	2.8
Benzo(a)pyrene*	C <sub>20</sub> H <sub>12</sub>	252	496	3.3 x 10 <sup>-4</sup>	3.4 x 10 <sup>-5</sup>	5.2	2.5
Benzo(g,h,i)perylene	C <sub>22</sub> H <sub>12</sub>	276	500	8.3 x 10 <sup>-4</sup>	5.9 x 10 <sup>-5</sup>	4.7	1.3
Indeno(1,2,3-cd)pyrene*	C <sub>22</sub> H <sub>12</sub>	276	..	9.5 x 10 <sup>-4</sup>	1.8 x 10 <sup>-4</sup>	6.1	2.5
Dibenzo(a,h)anthracene*	C <sub>22</sub> H <sub>14</sub>	278	524	<7.5 x 10 <sup>-4</sup>	<3.8 x 10 <sup>-4</sup>	2.9	>2.5
Dibenzofuran	C <sub>12</sub> H <sub>8</sub> O	168	287	..	..	..	..

\*Carcinogenic [6].

\*\*Based on Site 2 samples for volatiles and Site 1 samples for semivolatiles.

Pre- and post-treatment analyses were performed on samples from all three sites to determine the initial and final concentrations of semivolatile organic compounds (SVOCs) using U.S. EPA Methods 8310 or 8270. Lower detection limits for Sites No. 1 and 3 were achieved using Method 8310, which utilizes high-performance liquid chromatography (HPLC) and UV fluorescence detection. Samples from Site 2 had higher detection limits because Method 8270 is a lower resolution gas chromatography/mass

spectrometry (GC/MS) technique. Initial BTEX concentrations were determined for MGP Site No. 1 using U.S. EPA Methods 5030/8020, while pre- and post-treatment levels of BTEX were determined for Site No. 2 using EPA Method 8240B. For Site No. 3, the initial concentrations of total petroleum hydrocarbons (TPH) and soil-leachable total organic carbon (TOC) were determined using U.S. EPA Methods 418.1 Modified and 415.1 Modified, respectively. All post-treatment analyses were performed within the applicable U.S. EPA holding times following removal of the heated samples from the oven.

## Treatability Results

Volatile Organics. Concentrations of benzene in samples from MGP Site No. 2 were reduced from 39,000 µg/kg initially to only 22 µg/kg after as little as 1 day of heating at 200°C (Table 1).

Semivolatile Organics. Contaminant concentrations were progressively reduced by heating at higher temperatures or for longer periods of time at the same temperature (Table 1). For the most heavily contaminated samples from Site 1, the percent of Detectable SVOCs removed was 99.9958% after one day of heating at 400°C. Heating for three days at only 300°C provided even better results, with 99.9994% contaminant mass removal. The greatest residual concentration of any individual PAH was 570 µg/kg following one day of heating at 400°C and only 71 µg/kg after 3 days of treatment at 300°C. Similar results were obtained for MGP Site No. 3, the least contaminated soil, with 99.9992% SVOC mass removal after one day of heating at 350°C.

The fraction of contaminant removed was generally greatest for the lightest PAH components having the lowest boiling points and gradually decreased as the molecular weight and boiling points increased (Table 2 and Figures 2-8). For Site 1, concentrations of the lightest PAH, naphthalene, were reduced to less than  $1.8 \times 10^{-6}$  of their initial values after one day of heating at 400°C, whereas the heaviest PAHs such as indeno(1,2,3-cd)pyrene and dibenzo(a,h)anthracene had residuals on the order of  $10^{-3}$  of their initial values. Final-to-initial ratios resulting from three days of heating at 300°C ranged from less than  $9.2 \times 10^{-7}$  for naphthalene to less than  $3.8 \times 10^{-4}$  for dibenzo(a,h)anthracene.

Initial concentrations of naphthalene as high as 18,000,000 µg/kg at Site No. 1 were reduced to non-detectable levels (less than 33 µg/kg) after one day of heating at 400°C. There was some variation in the naphthalene reduction with temperature from one site to another, with a greater rate of reduction in the Site 2 samples and a lesser rate of reduction for Site 3 in comparison with Site 1 (Figure 2). This variation probably results from differences in the initial concentrations and the type of matrix (coal tar or soil type).

Phenanthrene and anthracene, with molecular weights of 178 and boiling points of 340°C, exhibit similar behavior when their concentrations are normalized to their initial pre-treatment values (Figure 3). Similarly, fluoranthene and pyrene, with molecular weights of 202 and boiling points near 390°C, desorb almost identically with increasing temperature and time.

The reduction in concentrations of fluoranthene and pyrene with time for a constant temperature of 300°C is shown in Figure 4. Simple thermal desorption of adsorbed molecules from smooth surfaces should follow first-order kinetics, with  $C = C_0 e^{-k t}$ , where  $C_0$  is the initial contaminant concentration,  $C$  is the concentration at time  $t$ , and  $k$  is the first-order rate constant or exponential decay constant [7]. For most soils other than clean sands, the thermal desorption is more complex. Uzgiris et al. [7] described thermal desorption of PCBs from montmorillonite clay soils as having an initial exponential decay followed by a much slower reduction in concentration of the recalcitrant fraction that is presumably tightly bound in the intercrystalline water layers of the clays. Based on the limited data from our treatability study, it appears that the time decay shown in Figure 4 is likewise not purely exponential but

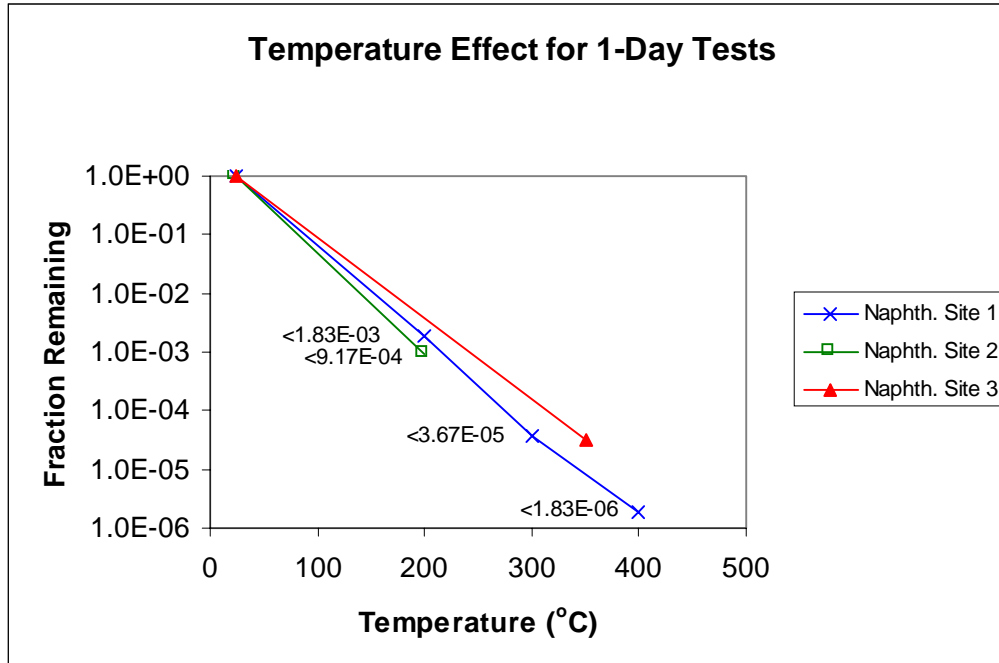

Figure 2. Fraction of initial concentration of naphthalene remaining after 1-day treatability tests as function of temperature for all sites.

is more rapid during the first day and somewhat less rapid thereafter. For comparative purposes, it is convenient to define apparent initial and final decay constants  $k_i$  and  $k_f$ , respectively, where:

$$C_1 = C_0 e^{-k_i (t_1 - t_0)} \quad (1a)$$

$$C_3 = C_1 e^{-k_f (t_3 - t_1)} \quad (1b)$$

Times  $t_0$ ,  $t_1$ , and  $t_3$  correspond to 0, 1, and 3 days, respectively, and  $C_0$ ,  $C_1$ , and  $C_3$  are the initial, one-day, and three-day concentrations. Solving Equations (1) for  $k_i$  and  $k_f$  yields

$$k_i = \ln(C_0/C_1) \text{ day}^{-1} \quad (2a)$$

$$k_f = \frac{1}{2} \ln(C_1/C_3) \text{ day}^{-1} \quad (2b)$$

The apparent decay constants defined by Equations (2) are  $k_i$  equals 4.7 per day for fluoranthene and pyrene, with  $k_f$  slightly smaller at 3.5 per day for fluoranthene and 3.3 per day for pyrene (Table 2).

The time and temperature behavior of the carcinogenic PAHs that have boiling points in the range of 400°C to 480°C are summarized in Figure 5. Benzo(a)anthracene and chrysene, with molecular weights of 228, have slightly lower contaminant fractions remaining after both one and three days of heating than the heavier benzo(b)- and benzo(k)fluoranthene (molecular weights of 252). The initial decay rates with time are again somewhat more rapid than the final decay rates (Figure 6). There is also a trend of decreasing decay rates with increasing molecular weight and boiling point (Table 2).

Figure 7 summarizes results for the heaviest PAHs, which have boiling points near 500°C. Benzo(a)pyrene, which is usually the heaviest PAH of concern, exhibits reduced concentrations with

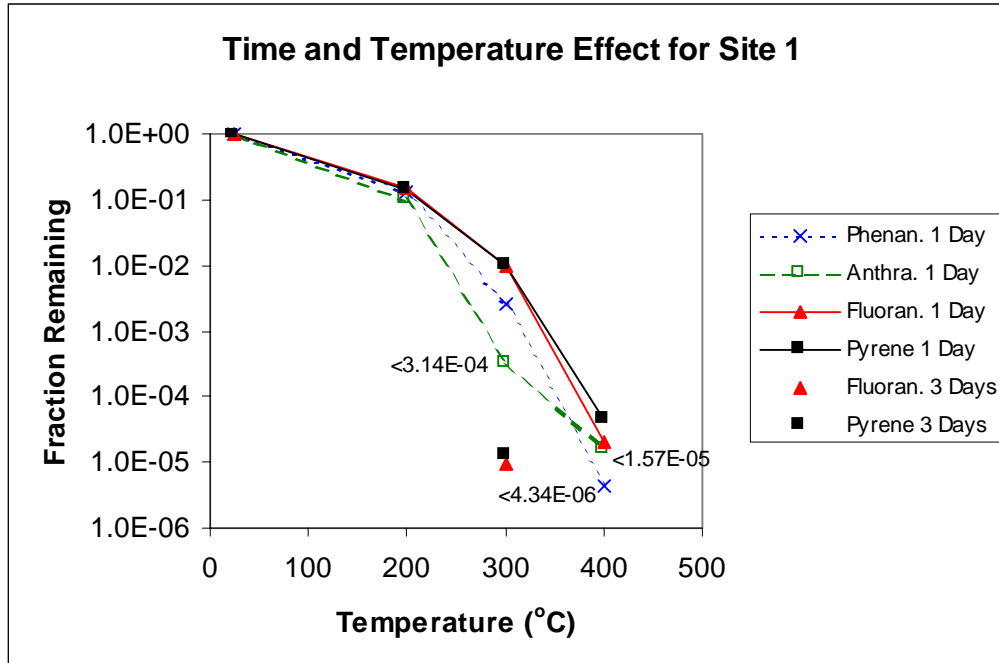

Figure 3. Fraction of initial concentration of phenanthrene, anthracene, fluoranthene, and pyrene remaining as function of temperature for Site 1 samples.

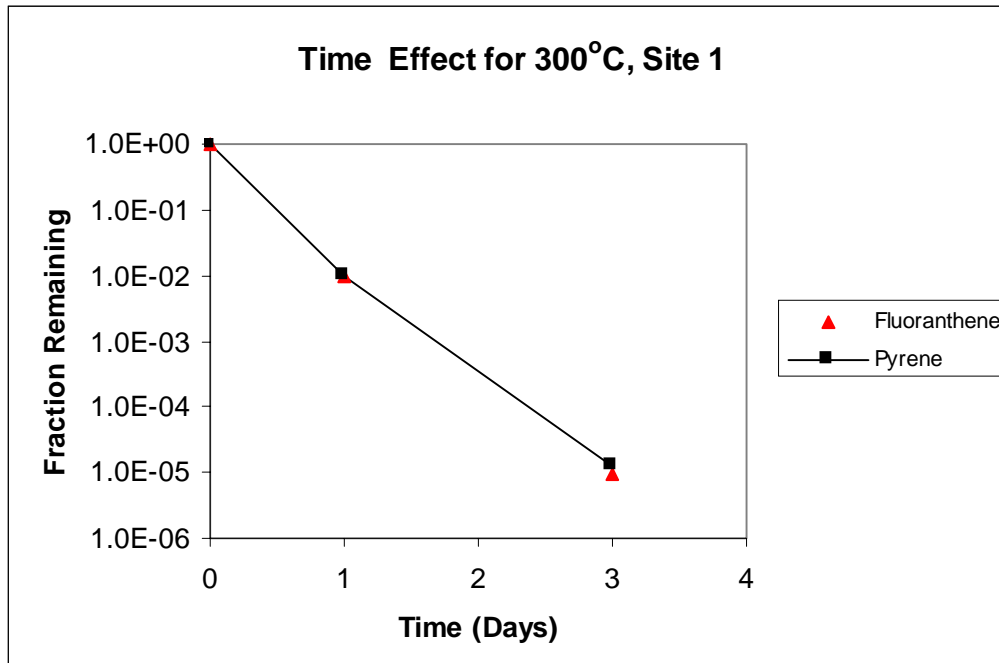

Figure 4. Fraction of initial concentration of fluoranthene and pyrene remaining as function of time at 300°C for Site 1 samples.



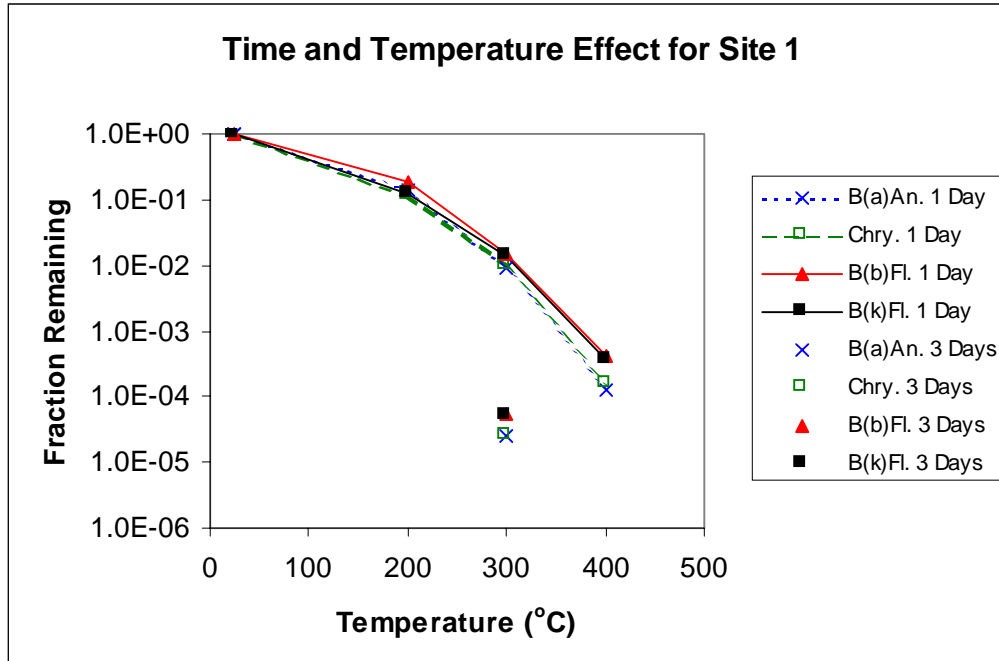

Figure 5. Fraction of initial concentration of benzo(a)anthracene, chrysene, and benzo(b)- and benzo(k)fluoranthene remaining as function of temperature for Site 1 samples.

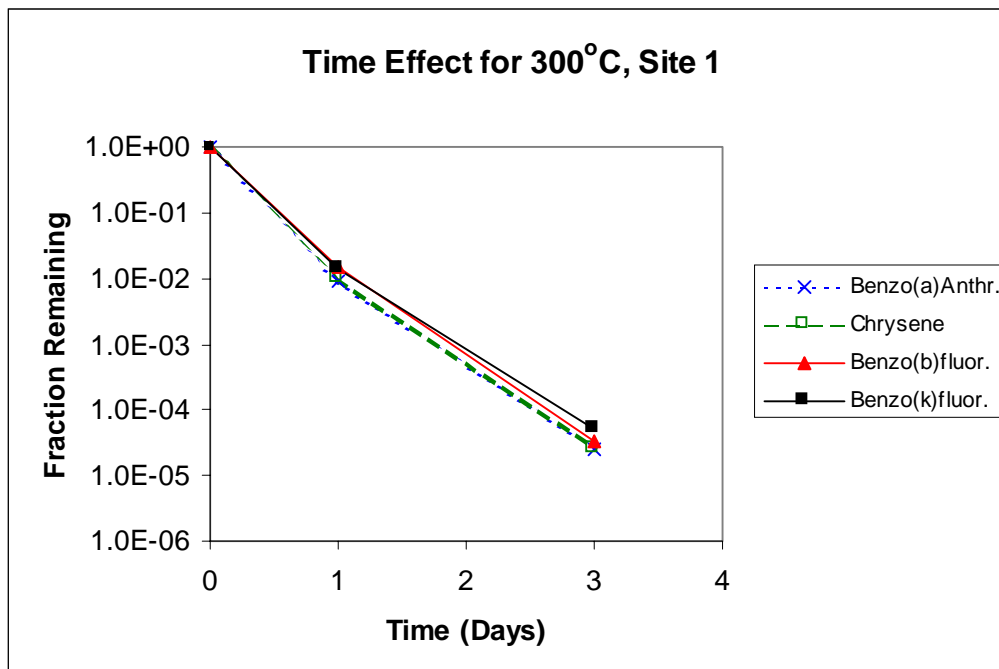

Figure 6. Fraction of initial concentration of benzo(a)anthracene, chrysene, and benzo(b)- and benzo(k)fluoranthene remaining as function of time at 300°C for Site 1 samples.

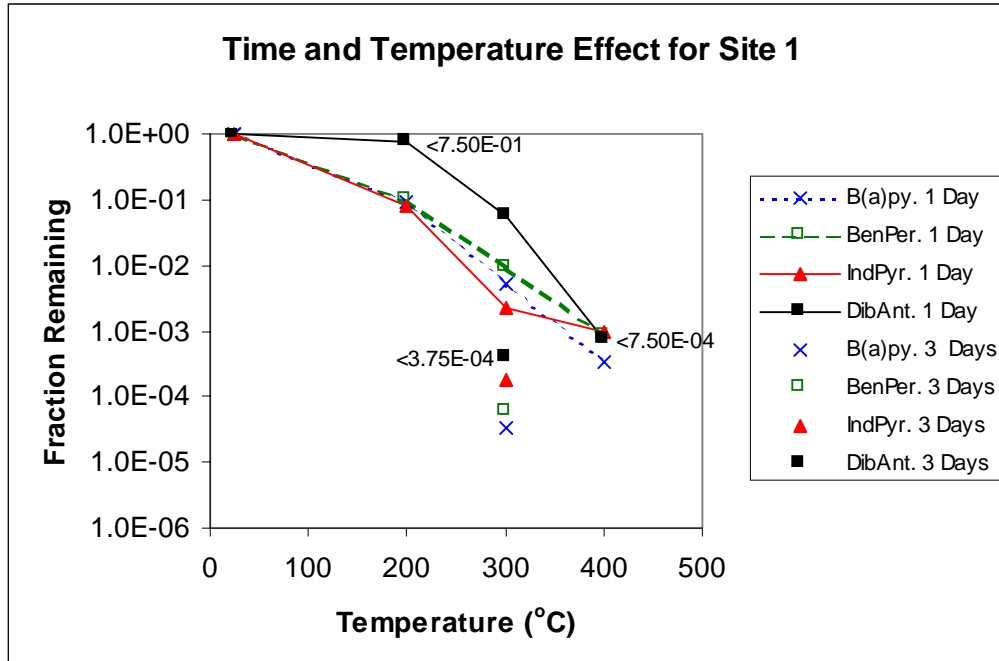

Figure 7. Fraction of initial concentration of benzo(a)pyrene, benzo(g,h,i)perylene, indeno(1,2,3-cd)pyrene, and dibenzo(a,h)anthracene remaining as function of temperature for Site 1 samples.

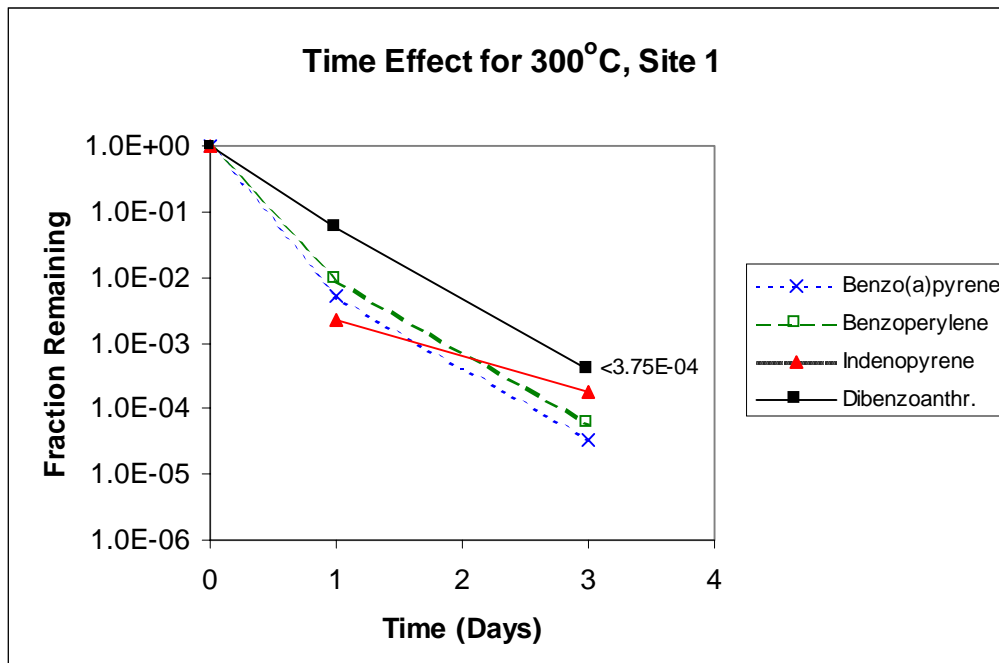

Figure 8. Fraction of initial concentration of benzo(a)pyrene, benzo(g,h,i)perylene, indeno(1,2,3-cd)pyrene, and dibenzo(a,h)anthracene remaining as function of time at 300°C for Site 1 samples.

temperature comparable to what was observed for benzo(b)- and benzo(k)fluoranthene, all with molecular weights of 252. The heaviest PAH, dibenzo(a,h)anthracene, has a potential carcinogenic potency comparable to that of benzo(a)pyrene [6] but typically occurs with much lower concentrations in MGP waste and is therefore of less concern. Nevertheless, significant reductions in the dibenzo(a,h)anthracene concentrations were realized for temperatures of 300°C and greater.

The time decay of these heavier PAHs (Figure 8) was more variable than for the lighter components, but dibenzo(a,h)anthracene had the slowest apparent decay constants ( $k_i = 2.9$  per day, and  $k_f \geq 2.5$  per day) consistent with the general trend of decreasing decay rates with increasing molecular weights. Dibenzo(a,h)anthracene was also the only PAH that exhibited nearly exponential decay ( $k_i$  equal to  $k_f$ ), and this decay rate was comparable to the apparent  $k_f$  for the lighter components. This may reflect that the treatment temperature of 300°C was well below the boiling point of dibenzo(a,h)anthracene such that the accelerated initial decay rate typically observed at this temperature for the lower boiling PAHs was not realized. Nonetheless, 300°C was sufficient to reduce the concentrations of dibenzo(a,h)anthracene to non-detectable levels (less than 16.5 µg/kg) after three days of treatment.

These treatability tests clearly demonstrate the beneficial effect of a combination of elevated temperature and long treatment time. Typical *ex situ* thermal desorbers, where residence times are measured in minutes rather than days, would not achieve the low contaminant residuals obtained above. In contrast, ISTD field projects [3,5] have maintained even higher temperatures for longer periods of time and can therefore achieve even lower residual levels of contamination.

#### TAR-DRUM EXPERIMENTS AT GASMER ROAD

Remediation experiments on drums filled with soil contaminated with tar were performed in March and April of 1998 at Shell's Gasmer Road test facility. The experiments were conducted with a commercial roofing tar as the surrogate contaminant representing MGP coal tar (Table 3). The tar was composed primarily of C<sub>32</sub>-C<sub>35</sub> hydrocarbons, with trace amounts of the lighter, noncarcinogenic PAHs such as naphthalene (Table 4). Thus successful removal of the heavy roofing tar would also confirm the ability of ISTD to remove the coal-tar PAHs, which are mostly in the range of C<sub>10</sub>-C<sub>22</sub> hydrocarbons.

Table 3. Tar Properties

Specific Gravity <sub>60°/60°F</sub>	1.0356
Specific Heat <sub>300°F</sub> , Btu/(lbm F°)	0.523 Btu/(lbm F°)
Specific Heat <sub>500°F</sub> , Btu/(lbm F°)	0.613 Btu/(lbm F°)
Softening Point, °F	195 - 205
Viscosity <sub>350°F</sub> , cp	900
Viscosity <sub>450°F</sub> , cp	90
Viscosity <sub>575°F</sub> , cp	15 (estimated)
Flash Point, °F	525-600
Composition, wt %	C = 85.5, H = 10.5, S = 2.75, O = 1.00

The experiments were run inside heavy-walled drums that could have built up pressure. The drums were therefore placed in a 5-foot x 12-foot x 1-foot deep spill pan and covered with a framework of pipe and a sheet-steel roof to protect the surrounding area from possible tar “burps” and spillage. The models were located within the bounds of two concrete walls for additional personnel protection.

Table 4. Soil Analyses from Tar Drum Experiments

Constituent	TD-1 and TD-2		Heated TD-2		Units
	Initial Sand	Initial Tar	Tar/Sand Layer (10-43 in.)	Clean Sand Layer (43-60 in.)	
Polyaromatic Hydrocarbons (EPA Method 8310)					
Naphthalene	<49.5	11	<3.3	NA	µg/kg
1-Methylnaphthalene	<99.0	<6.6	<6.6	NA	µg/kg
2-Methylnaphthalene	<99.0	<6.6	<6.6	NA	µg/kg
Acenaphthylene	<49.5	<3.3	<3.3	NA	µg/kg
Acenaphthene	<124.5	<8.3	<8.3	NA	µg/kg
Fluorene	<124.5	9	<8.3	NA	µg/kg
Phenanthrene	<49.5	13	<3.3	NA	µg/kg
Anthracene	<49.5	14	<3.3	NA	µg/kg
Fluoranthene	<49.5	33	<3.3	NA	µg/kg
Pyrene	<49.5	<3.3	<3.3	NA	µg/kg
Benzo(a)anthracene*	<49.5	<3.3	<3.3	NA	µg/kg
Chrysene*	<49.5	<3.3	<3.3	NA	µg/kg
Benzo(b)fluoranthene*	<49.5	<3.3	<3.3	NA	µg/kg
Benzo(k)fluoranthene*	<49.5	<3.3	<3.3	NA	µg/kg
Benzo(a)pyrene*	<49.5	<3.3	<3.3	NA	µg/kg
Benzo(g,h,i)perylene	<49.5	<3.3	<3.3	NA	µg/kg
Indeno(1,2,3-cd)pyrene*	<49.5	<3.3	<3.3	NA	µg/kg
Dibenzo(a,h)anthracene*	<49.5	<3.3	<3.3	NA	µg/kg
Detectable PAHs		80			µg/kg
Petroleum Hydrocarbons (ASTM D-2887 Modified)					
C8-C9	NA	<15,000	<10	NA	mg/kg
C10-C11	NA	<15,000	<10	NA	mg/kg
C12-C13	NA	<15,000	<10	NA	mg/kg
C14-C15	NA	<15,000	<10	NA	mg/kg
C16-C17	NA	<15,000	<10	NA	mg/kg
C18-C19	NA	<15,000	<10	NA	mg/kg
C20-C23	NA	<15,000	<10	NA	mg/kg
C24-C27	NA	<15,000	<10	NA	mg/kg
C28-C31	NA	<15,000	<10	NA	mg/kg
C32-C35	NA	17,000	<10	NA	mg/kg
C36-C39	NA	<15,000	<10	NA	mg/kg
C40-C43	NA	<15,000	<10	NA	mg/kg
C44+	NA	<15,000	<10	NA	mg/kg
Detectable PHCs		17,000			mg/kg
Total Organic Carbon (Weight Percent in Soil, Walkley-Black Method)					
Carbon in Soil	NA	1.8	<0.06	<0.06	wt%
Total Organic Carbon (Soil Leachable, EPA Method 9060 Modified)					
Soil Leachable Carbon	30	30	<10	NA	mg/kg

\*Carcinogenic [6].

NA - not analyzed.

## Objectives of Field Experiments

The overall objective of these tests was to learn if ISTD could be used to remediate MGP waste. The experiments were designed to study the level of cleanup that could be obtained starting from very high organic contaminant levels. A secondary objective was to test if coking of the MGP waste during the heating process would plug the well bore. Other issues addressed by the experiments were: (1) potential pressure buildup due to low permeability, (2) tar migration to clean areas, (3) surface subsidence, (4) design of surface equipment for this remedial process, and (5) the temperatures required to effectively operate a heater/suction well.

### Preliminary Experiment TD-1

A preliminary tar drum experiment, TD-1, was performed to determine the limits of contamination that could be treated with our first well completion design and to assess operational problems that might be encountered in an MGP remediation. Over 900 pounds of tar were used in this 3-foot diameter drum experiment. The tar was placed in three layers, consisting of 12 inches of 30% by weight of tar mixed with sand, 14 inches of pure tar, and 12 inches of 30% tar mixed with sand (Figure 9). Clean sand layers were placed below and above the tar layers. A free water table was established in the clean sand at the bottom of the drum, and the upper layers contained approximately 10% water by weight. A 2-inch clay layer on the upper sand provided a top seal for the vessel.

The central heater/vacuum well was a 4-inch diameter casing placed in an 8-inch diameter hole with a sand-packed annulus. The well was completed with 1/32-inch slots, 2 inches long. Inside the casing, a 2 7/8-inch diameter heater-can contained a nichrome heating element 50 inches long that supplied electrical energy for the experiment. In the sand outside the casing, a spirally wound 3/8-inch tubing, perforated with 1/32-inch orifices, could be used to inject air, other gases, or water for coke suppression.

The experiment was performed during the period of March 5-11, 1998. Initially, a vacuum of 5 inches of water that was imposed in the well provided a small negative pressure in the soil. The vacuum resulted in a flow of 20 standard cubic feet per minute (scfm) of vapors from the drum plus 10 scfm of air that was injected through the orifices. The heater was energized initially with about 5 kW of electrical power. During the test, the power was decreased to 3.5 kW in order not to exceed a maximum heater temperature of 1650°F (899°C). Two and one-half hours after the start of heating, the air injection through the orifices resulted in a noticeable exothermic reaction with the tar. Injection of nitrogen through the orifices quickly quenched the temperature rise, and heating was continued for 5 days. Early in this period, the tar layer melted and flowed freely into the well, exceeding the oxidation capacity of the orifice air stream and plugging the slots. As a result of these operational difficulties, the heating was terminated before the tar and sand layers were fully heated. Near the center of the drum, at 6 inches from the well screen, the temperature reached about 1000°F (~540°C). However, at 12 inches from the screen, the temperatures averaged only 400°F (~200°C), and at the walls near the top and bottom they were less than 200°F (~90°C).

In spite of the early termination of heating, the remediation removed almost 18 inches of tar from the drum. An inspection of the drum at the end of the test revealed: (1) some regions of clean sand, (2) a greater volume of sand coated with what appeared to be "dead carbon", (that is, dry non-vitreous carbon), and (3) a few regions of unaltered tar. The TD-1 experiment provided insight for well design improvements that were incorporated in the second test.

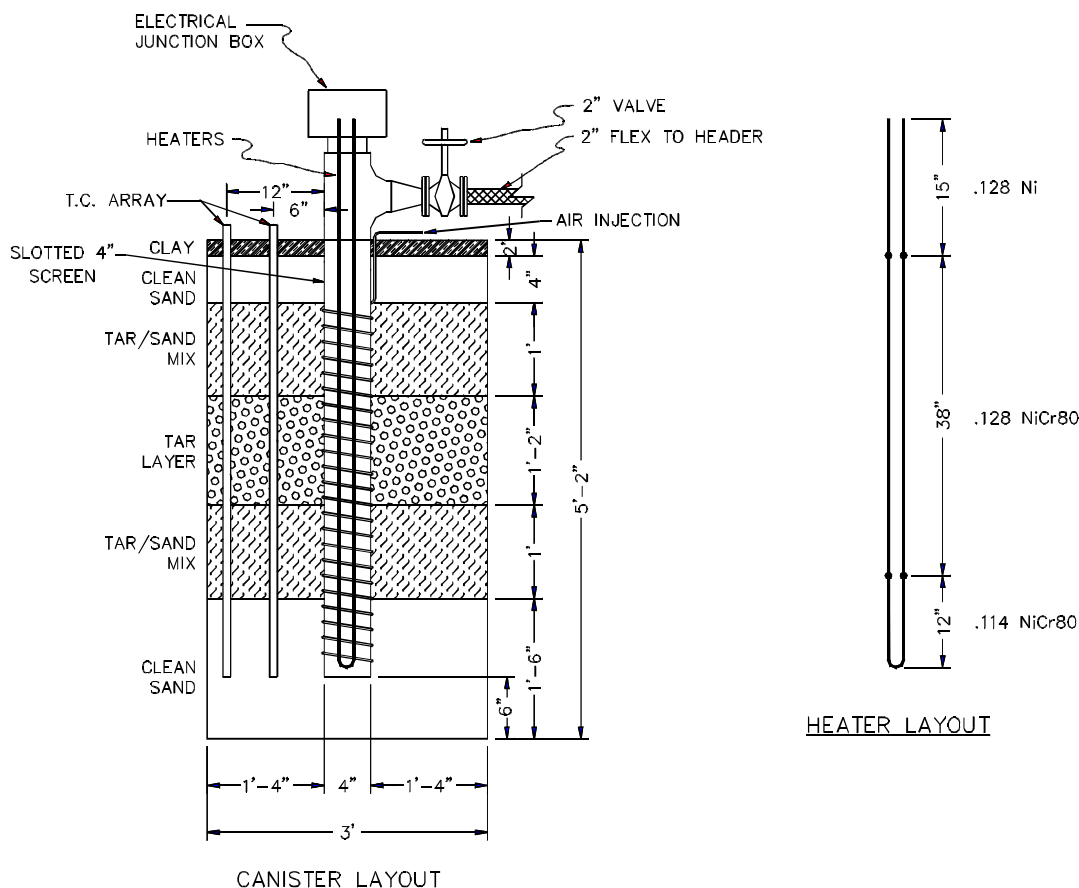

Figure 9. Schematic of tar drum and soil layers (left) and heater detail (right) for TD-1.

### Tar Drum Experiment TD-2: Description of Equipment

Model Construction. The model of the tar-contaminated soil was constructed using a 3-foot diameter, 3/8-inch-thick wall by 5-foot-long pipe, with a 1/4-inch steel plate welded to the bottom (Figure 10). The model contained three pressure ports in the soil, 8 inches from the wall, that were fitted with pressure/vacuum gauges capable of reading  $\pm 10$  inches  $H_2O$ . The upper port was located in the upper clean sand 2 inches above the tar layer, the middle port was centered in the tar layer, and the lower port was placed 2 inches below the tar layer. A 500-psi pressure relief valve was located 12 inches from the bottom of the vessel, and a drain/fill port was located in the bottom edge of the vessel. The port was used to raise and lower the water level during the initial wetting of the soil.

External heaters provided a no-heat-flow boundary condition at the outer wall of the drum. The external heaters were covered with five inches of insulation, and a sheet-metal cowling completed the drum exterior. The external heaters were adjusted to slightly lag the rise in wall temperature that resulted from heating of the soil at the center well.

A shimstock sheet was placed over the drum to provide the vapor barrier over the soil. Eight inches of high-temperature mineral wool insulation was placed over the shimstock cover to reduce heat losses at the top.

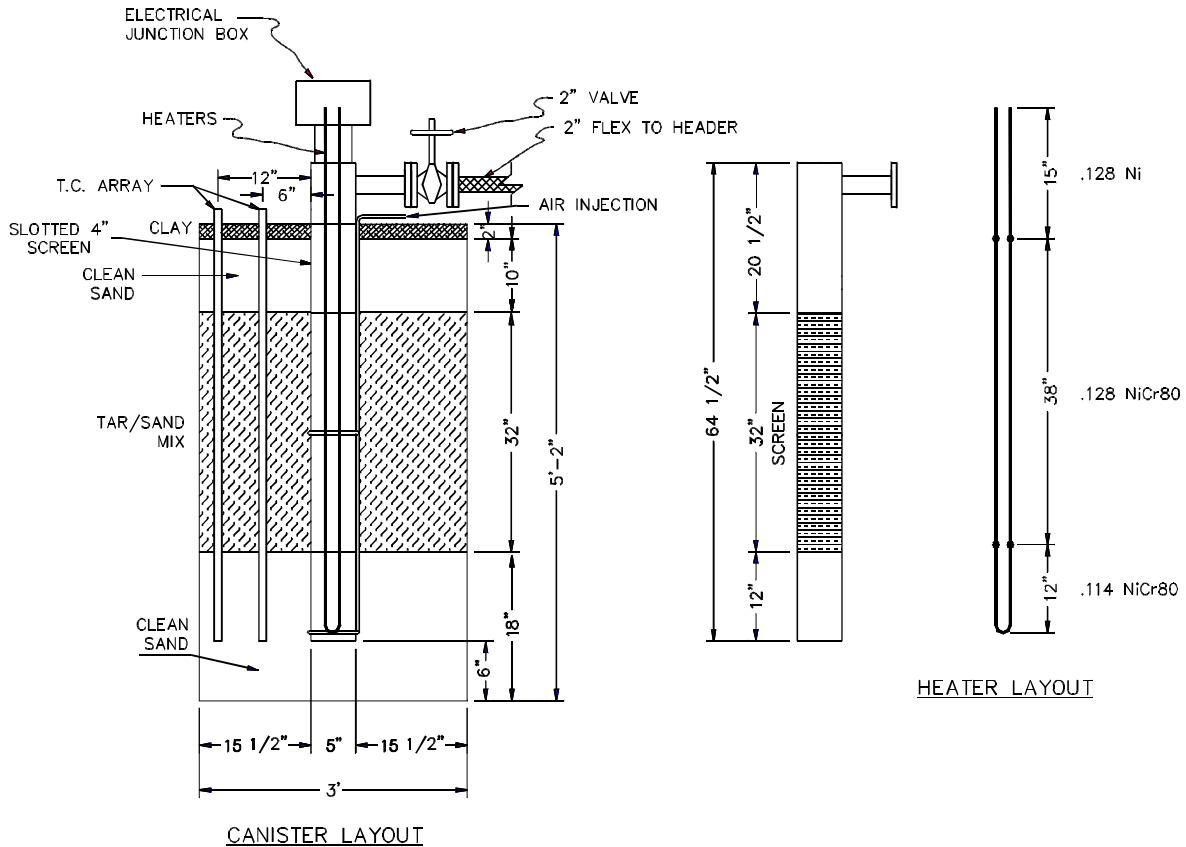

Figure 10. Schematic of tar drum and soil layers (left), well screen (middle), and heater detail (right) for experiment TD-2.

**Sand – Sand/Tar Mixture.** The drum model for TD-2 was filled in five layers using washed 40/70 mesh silica sand, roofing tar, and fresh water. The bottom layer was 18 inches of clean sand, which was packed using a hand tamper. The next 32-inch layer was comprised of 1800 lbs of sand and 200 lbs of tar chunks (10% by weight). The mixture was mixed in a wheelbarrow with a shovel, then placed in the vessel and packed. The remaining 10.5 inches was filled with clean sand. A 2-inch layer of clay was placed on this upper sand to reduce air influx from the surface. After filling the drum, the sand was saturated with water and allowed to drain back to residual water saturation.

**Well Construction.** An 8-inch diameter cylinder was temporarily placed in the vessel during the filling phase to hold open an 8-inch well bore. A 5-inch diameter well screen was then placed in the vessel and the annulus was packed to the surface with 16/30 mesh sand. The top foot and bottom foot of the well casing were solid pipe. The center 32-inch section of the well opposite the contaminated soil was standard well screen with 0.020-inch openings and 40% open area. The bottom of the casing pipe was welded closed with a plate, and the top of the pipe had a 5-inch welded tee, which functioned both as the suction port and the heater entrance. The vacuum/heater well extended 12 inches into the clean sand below the contaminated sand zone.

The well had two perforated 3/8-inch tubes wrapped around it for coke suppression: one tubing ring at the midpoint of the screen and one tubing at the bottom of the well in the solid pipe section. The

tubing was drilled with six 1/32-inch diameter holes on the underside that could be used for injecting air or water for coke suppression. The orifices were sized for a critical flow of 1 scfm per tube at 30 psi upstream air pressure.

The heater was constructed of two nichrome bead heaters, wired in series to a 480-volt power source; each heater was 4 feet 2 inches long. The electric heating elements were constructed of 0.128-inch o.d. nichrome wire in the center section and a one-foot boosted power section at the bottom with 0.114-inch wire. The boosted section supplied 28% more power than the main section. The nichrome wire was insulated with high alumina beads. The heaters hung freely inside a 2 7/8-inch diameter, 304 stainless-steel heater can with the lower end sealed. The controller could deliver up to 1750 watts/foot to the heater using 480-volt single-phase power. This design was capable of higher heating rates than used in previous ISTD projects because of the airflow through the coke suppression tubes. The heater temperatures were monitored with inconel-sheathed, mineral-insulated type K thermocouples located in holes in the alumina beads. The control thermocouples were not allowed to exceed 1750°F (954°C).

Temperature Measurements. A total of 36 thermocouples was used to monitor heating within the soil, wells, and surface equipment. The temperature in the soil was measured at three radial distances (0, 6, and 12 inches from the well screen) and at five depths (10, 20, 28, 36, and 45 inches from the top of the drum). Two thermocouples were installed inside the heater can; one was located in the power-boosted section of heater and the other in the normal section of heater. A thermocouple was installed in the piping at six locations: the outlet of the well, before and after the blower, before the carbon bed, after the carbon bed, and in the stack.

Process System. The outlet of the well screen was flanged to a stainless steel knife-gate valve and connected to a 1½-inch diameter flex hose, and then to the header. The header was a 4-inch diameter steel pipe, approximately 30 feet long and extending from the well to the separator. The 4-inch pipe was insulated and could be heated to a maximum of 700°F (371°C).

The separator was cooled by circulating tap water through a copper tubing wrapped along the length of the vessel. The bottom of the separator had a reservoir, which was heated to approximately 300°F (~150°C). This heated reservoir allowed any tar condensing from the stream to be drained from the system. The separator could also be heated electrically to avoid plugging, but it had a vertical-access cleanout port in case plugging did occur.

The vapor collection system used a high-volume New York blower to evacuate the soil. A knife valve was installed immediately upstream of the blower to control the airflow from the well. A fresh air inlet was also installed upstream of the blower to provide dilution air, if necessary.

Airflow measurements from the wells were made with a large (30-scfm) wet test meter located between the blower and the carbon bed. A Pitot tube was used to make the velocity measurements in the fume line between the well and the separator.

A 500-lb granular activated carbon (GAC) bed was installed in the system exhaust to adsorb odors from the vapor stream. A 20-foot-high stack was placed at the outlet of the carbon bed. Thermocouples were placed along the flow line to the stack in order to measure exhaust vapor temperatures. The emissions were monitored with five continuous emission analyzers, logged continuously for dry oxygen, wet oxygen, carbon monoxide (CO), carbon dioxide (CO<sub>2</sub>), and total hydrocarbons (THC). Samples were taken in the exhaust stack after the blower using an extractive sample probe.



## Operation of Experiment TD-2

Startup of Experiment. In preparation for startup, pressure instruments were checked and emission analyzers were calibrated with certified standard reference gases. The blower was started to balance the flow from the well with approximately 15 inches H<sub>2</sub>O vacuum. Computer data collection was started, and emission data were recorded for two hours to establish a baseline before heat was applied. Next, the heaters were energized at an average initial injection rate of 1700 watts/foot (7100 watts/4.17-foot heater length, see Figure 11). When any heater temperature exceeded 1750°F (954°C), power was turned off to the heaters for up to one hour.

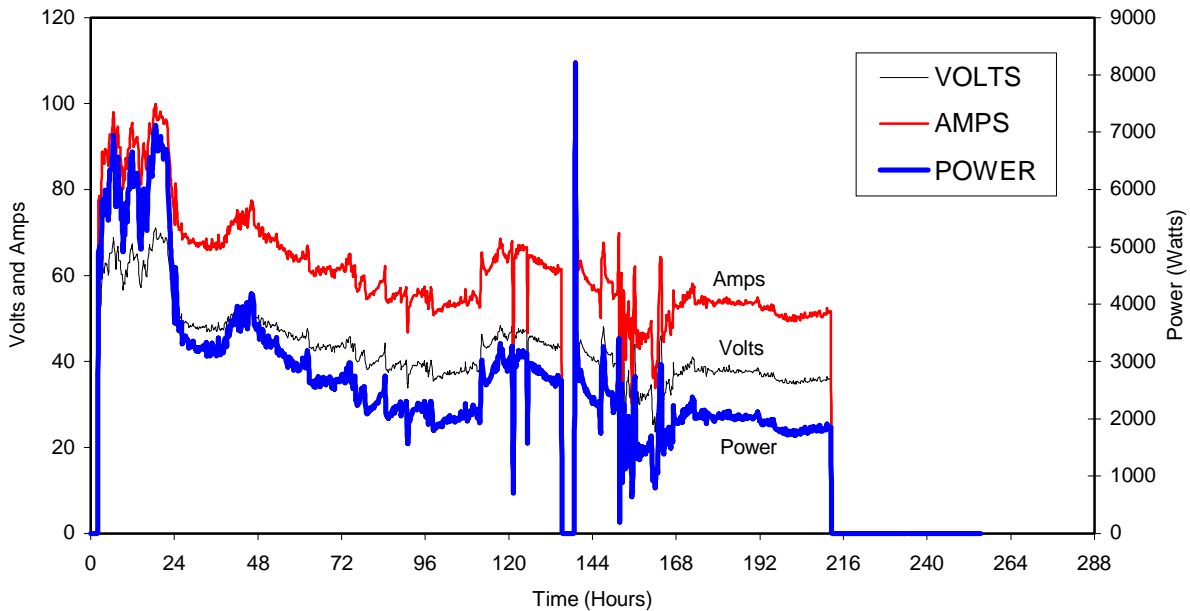

Figure 11. Current (amps), potential (volts), and power (watts) utilized by well heater for TD-2.

The flow rate from the heater/suction well was maintained at 4-5 scfm. During initial heating, the vacuum at the well was -5 inches H<sub>2</sub>O, and the vacuum in the soil near the drum was -4 inches H<sub>2</sub>O. As the soil dried out and the vapor flow increased, the well was throttled back to 4-5 scfm. A vacuum was maintained in the soil throughout the test.

Operational Results. Tar drum experiment TD-2 was run until all the temperatures within the drum exceeded 900°F (~480°C) and the THC and water content of the vapor had dropped to negligible levels. The drum was heated for approximately 211 hours and allowed to cool for another 48 hours before it was dismantled. During the 211 hours of the experiment there was no odor emitted from the drum or from the stack. Based on temperature and emission data, virtually all the organics were oxidized in the first 175 hours of heating.

No process problems were encountered in the drum; however, a build-up of condensed compounds in a short, uninsulated 2-inch header line between the wellhead and the main header resulted in a nearly complete tar plug in the line at 130 hours. The plug was removed and the section was insulated. No further problems were encountered in the remainder of the experiment.

The heater temperatures show the onset of the exothermic oxidation of the tar at about 12 hours (Figure 12). Thermocouple W2-B1 in the boosted section below the tar zone was initially hotter than the mid section thermocouple W2-H1; therefore, W2-B1 was used to control the heater temperature. When the tar began to oxidize, W2-H1 rapidly became the hottest thermocouple and was used to control the heater temperature. After 175 hours, when virtually all the organics were oxidized, W2-H1 dropped in temperature and control was switched back to W2-B1.

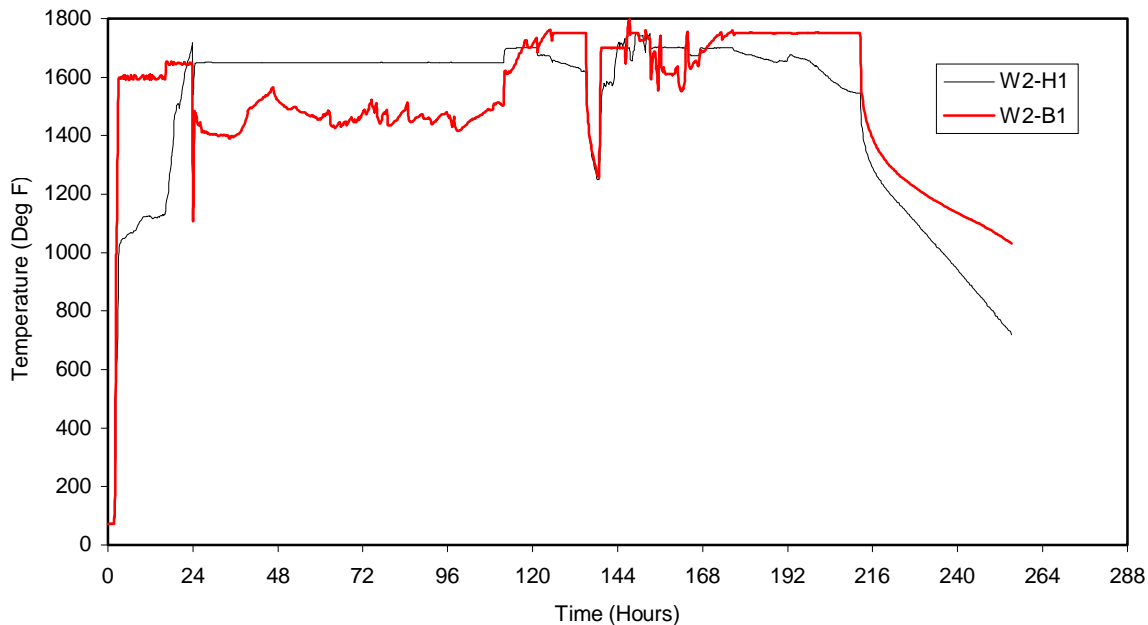

Figure 12. Heater temperatures for tar-drum experiment TD-2.

Figure 13 shows that the reaction started in the center of the contaminated zone (28-inch depth) and propagated downwards along the well screen to the 45-inch depth. The highest temperatures reached at the well screen were less than 1700°F (~930°C) and were controlled by the automatic decrease in the silicon controlled rectifier (SCR) power at about 20 hours. The electric power was automatically decreased during the remainder of the experiment as required to keep the well heater below 1750°F (954°C). The external heaters were controlled to slightly lag the 12-inch radial distance temperatures (Figure 14) to achieve essentially no radial heat losses at the drum wall. The maximum power applied on the external heaters was about 3 kW.

Figure 15 shows the temperature versus time at several positions along the piping train. The wellhead exhaust peaked at about 1000°F (540°C), and the vapor temperature decreased with distance towards the blower. There was no indication of combustion in the header piping train, which was gradually raised in temperature to 700°F (371°C) to oxidize any condensed carbon deposits. After dismantling, the header train was found to contain no carbon residue.

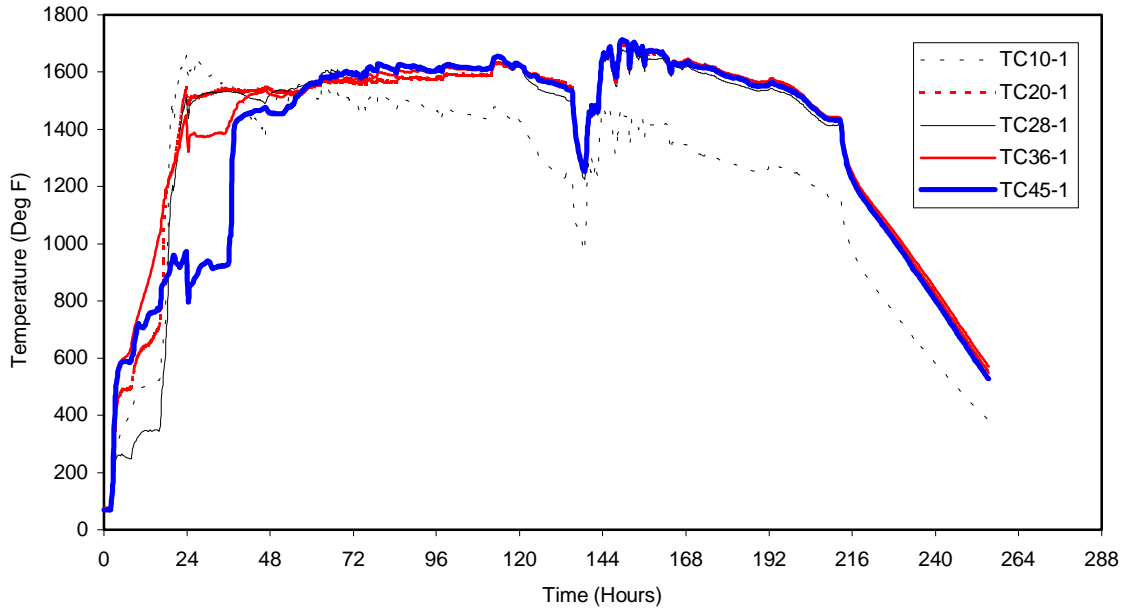

Figure 13. Well screen temperatures for experiment TD-2 at depths of 10, 20, 28, 36, and 45 inches.

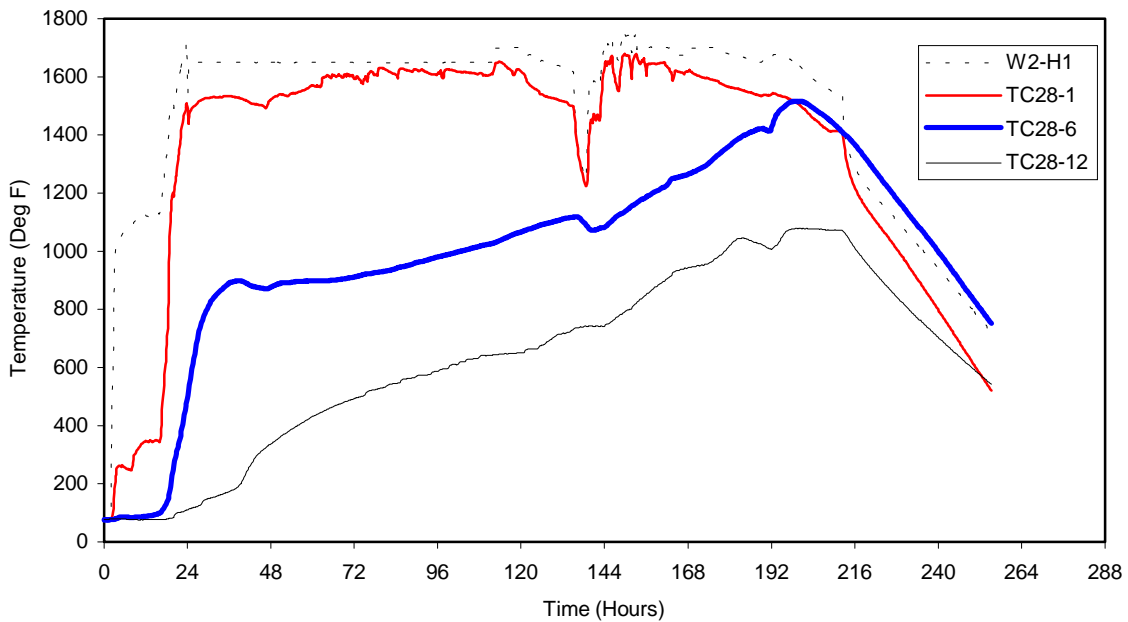

Figure 14. Temperature summary at depth of 28 inches for TD-2: heater temperature (W2-H1), well screen temperature (TC28-1), and soil temperatures at radial distances of 6 and 12 inches from well screen.

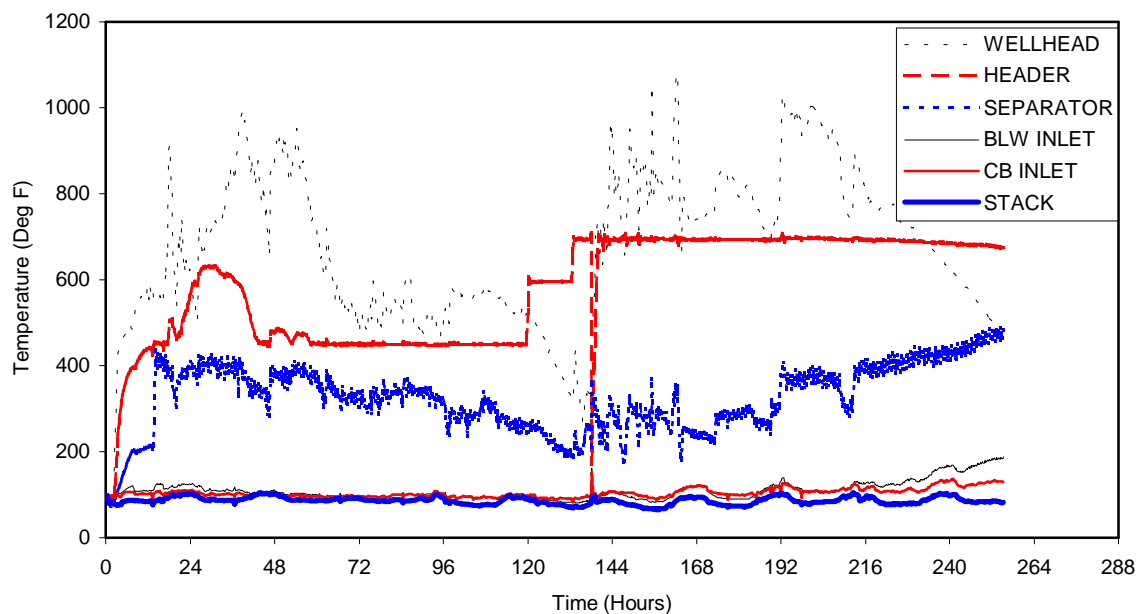

Figure 15. Temperatures associated with the offgas treatment system for TD-2, including the wellhead, header, separator, blower, carbon bed, and stack.

The stack emissions shown in Figure 16 reveal a sharp increase in THC and CO<sub>2</sub> beginning at 12 hours and lasting to 48 hours. After 48 hours the high-temperature zone around the heater well achieved temperatures high enough to oxidize the majority of the hydrocarbons *in situ*. The difference between wet and dry O<sub>2</sub> is a measure of the water vapor in the stack. Note that the moisture in the stack dries up at about 175 hours and the THC approaches zero parts per million (ppm).

### Post-Heating Results for TD-2

Excavation of Soil from the Drum. After allowing the soil to cool for two days, the drum was carefully dismantled, inspected, and sampled. On initial removal of the shimstock cover, the soil in the drum was observed to have subsided 3 ½ inches. This is consistent with having removed the 10% of load-bearing tar from the 32-inch contaminated section. The clay layer was desiccated and broken up, clearly no longer providing a flow seal. As the soil was excavated, it was observed to be completely clean sand down to 45 inches at all radial distances out to the wall of the drum. The soil was clean within a 6-inch radius of the well, even at the end below the heater. Coke residue was found in the soil by the wall of the drum between 45 and 62 inches. The lower portion of the tar appears to have been liquefied and moved below its initial lower boundary before being remediated at this deeper location. This region however had been heated above the expected remediation temperature. There was no odor associated with the coke residue inside the drum. There was no odor from inside the drum. No coke was visible within the well bore. The well screen appeared to be in good condition except for some surface oxidization. The orifices in the air-injection tubes were all open and flowing.

Sampling Results. Composite soil samples were taken at each 3-inch depth from the top to the bottom of the drum. These samples were then composited into two samples, one from the initially contaminated interval (10-43 in.) and the other from the underlying clean sand (43-60 in.). The resultant samples were analyzed for TOC, petroleum hydrocarbons (PHCs), and PAHs at Southern Petroleum Laboratories (SPL) in Houston, Texas (Table 3). All post-treatment analyses were non-detect.

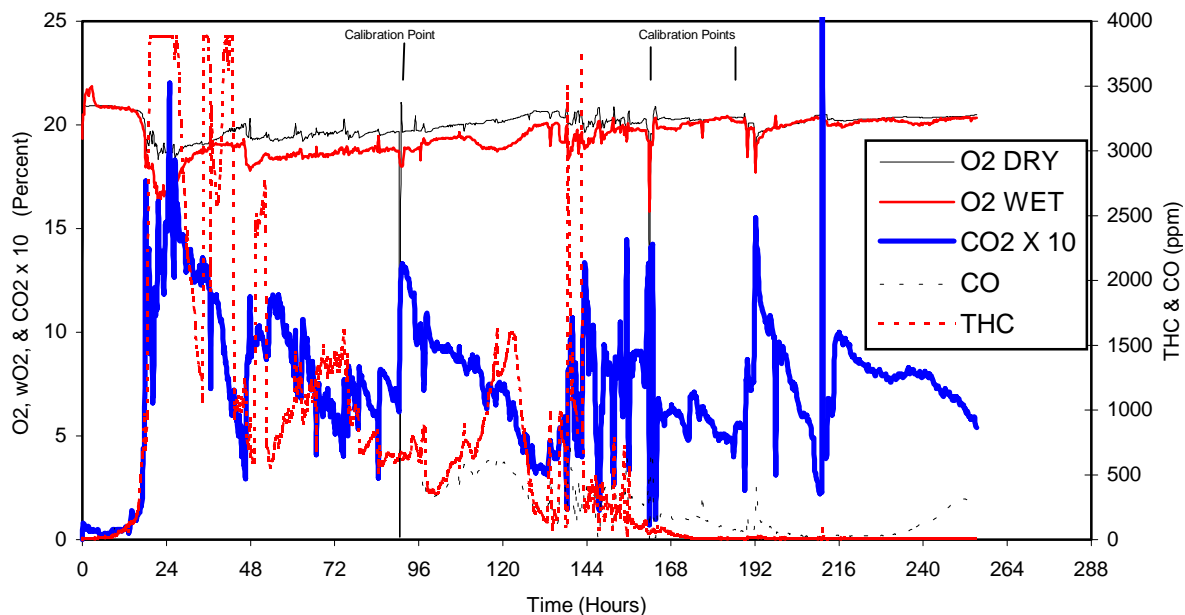

Figure 16. Stack emissions of dry O<sub>2</sub>, wet O<sub>2</sub>, CO<sub>2</sub>, CO and THC for tar-drum experiment TD-2. Because of instrument problems, CO was not recorded until 96 hours.

## CONCLUSIONS

### Treatability Studies

Concentrations of benzene in treatability samples were reduced from 39,000 µg/kg initially to only 22 µg/kg after as little as 1 day of heating at 200°C. Treating PAHs at higher temperatures or for longer periods of time at the same temperature progressively reduced their concentrations. For the most heavily contaminated samples, 99.9958% of the detectable SVOCs were removed after one day of heating at 400°C. Heating for three days at only 300°C provided even better results, with 99.9994% contaminant mass removal. The fraction of contaminant removed was generally greatest for the lightest components having the lowest boiling points.

At a constant treatment temperature of 300°C, the decrease in PAH concentrations was most rapid during the first day. The decay constants generally decreased with increasing molecular weight. The thermal desorption with both time and temperature was virtually identical for compounds having similar molecular weights and boiling points, such as fluoranthene and pyrene. Variations in the contaminant reduction in samples from different MGP sites probably resulted from differences in the initial PAH concentration and the amount of coal tar versus soil, indicating that site-specific treatability studies should be performed on MGP waste for optimum design of ISTD remediation projects. If required, even higher temperatures and longer heating times than those used in these treatability studies can be applied in the field.

### Drum Experiments

Results from the tar-drum experiments indicate that large amounts of tar can be removed by ISTD. For TD-2, all of the contaminants in the mixed tar/soil layer were removed and most of the tar was oxidized to CO<sub>2</sub> and H<sub>2</sub>O. Subsidence equal to the amount of original tar unsupported by mineral sand

grains occurred in both TD-1 and TD-2. In TD-2, no plugging occurred in the well screen or sand pack inside the drum. The well bore did not overheat from the tar oxidation, and temperatures were easily controlled in the surface piping and equipment. However, heat-traced and insulated header lines were required to prevent plugging of the lines.

### **Implications for Field Applications**

The laboratory treatability studies and the tar-drum experiments demonstrated that thermal-conduction heating and vacuum extraction is capable of completely removing even the highest boiling-point organic compounds from soil. The particular advantage of this process is its ability to attain very high temperatures and maintain them for many days. Both of these conditions are shown to be advantageous in the removal of contaminants to extremely low levels. With proper well designs, ISTD can safely and effectively remediate MGP wastes containing high concentrations of volatile and semi-volatile contaminants.

### **ACKNOWLEDGMENTS**

The authors thank TerraTherm Environmental Services Inc. and Shell Technology Ventures Inc. for permission to publish this paper, and Jim Behn of Lewiston Heat Gas Company and Terry Sciarotta of Southern California Edison for providing field samples for the treatability studies. John Reed of TerraTherm assisted with drafting and with assembly of the manuscript.

### **REFERENCES CITED**

1. Stegemeier, G. L. and Vinegar, H. J., "Soil Remediation by Surface Heating and Vacuum Extraction," paper SPE 29771 presented at the SPE/EPA Exploration & Production Environmental Conference, Houston, Texas, March 27-29, 1995.
2. Iben, I. E. T. et al., "Thermal Blanket for In-Situ Remediation of Surficial Contamination: A Pilot Test," *Environmental Science & Technology*, Vol. 30, No. 11, 3144-3154 (1996).
3. Sheldon, R. B. et al., "Field Demonstration of a Full-Scale In Situ Thermal Desorption System for the Remediation of Soil Containing PCBs and Other Hydrocarbons," paper presented at HazWaste World/Superfund XVII, Washington, DC, October, 1996.
4. Vinegar, H. J. et al., "Remediation of Deep Soil Contamination Using Thermal Vacuum Wells," paper SPE 39291 presented at the SPE Annual Technical Conference and Exhibition, San Antonio, Texas, October 6-7, 1997.
5. Vinegar, H. J. et al., "In Situ Thermal Desorption (ISTD) of PCBs," paper presented at HazWaste World/Superfund XVIII, Washington, DC, December, 1997.
6. U.S. Environmental Protection Agency, "Provisional Guidance for Quantitative Risk Assessment of Polycyclic Aromatic Hydrocarbons," EPA Report 600/R-93/089, July, 1993.
7. Uzgiris, E. E., Edelstein, W. A., Philipp, H. R., and Iben, I. E. T., "Complex Thermal Desorption of PCBs from Soil," *Chemosphere*, Vol. 30, No. 2, 377-387 (1995).