



United States
Department of
Agriculture

Forest Service

Forest
Products
Laboratory

Research
Paper
FPL-RP-617



In cooperation
with the

United States
Department of
Transportation

Federal
Highway
Administration



Polycyclic Aromatic Hydrocarbon Migration From Creosote-Treated Railway Ties Into Ballast and Adjacent Wetlands

Kenneth M. Brooks



Abstract

Occasionally, creosote-treated railroad ties need to be replaced, sometimes in sensitive environments such as wetlands. To help determine if this is detrimental to the surrounding environment, more information is needed on the extent and pattern of creosote, or more specifically polycyclic aromatic hydrocarbon (PAH), migration from railroad ties and what effects this would have on the surrounding environment. This study is a report on PAH level testing done in a simulated wetland mesocosm. Both newly treated and weathered creosote-treated railroad ties were placed in the simulated wetland. As a control, untreated ties were also placed in the mesocosm. Samples were taken of the ballast, wetland sediments, groundwater, stormwater, and soil cores. Ballast and sediment samples were taken at intervals during the 18 months of the study. Results of the study showed that there was an initial pulse of PAH moving from the treated railway ties into the ballast during the first summer of the study. More PAH moved from the newly treated ties than

from the weathered ties at this time. No significant PAH loss was observed from ties during the second summer. A small portion of PAH appeared to move vertically down into the ballast to approximately 60 cm. Small amounts of PAH may have migrated from the ballast into adjacent wetlands during the second summer, but these amounts were not statistically significant. These results suggest that it is reasonable to expect a detectable migration of creosote-derived PAH from newly treated railway ties into supporting ballast during their first exposure to hot summer weather. The PAH rapidly disappeared from the ballast during the fall and winter following this initial loss. Then statistically insignificant vertical and horizontal migration of these PAH suggests that they either evaporated or were degraded in the ballast. Effects of PAH on the environment are discussed in the Appendix.

Keywords: creosote, leaching, railway ties, wetlands, polycyclic aromatic hydrocarbons

June 2004

Brooks, Kenneth M. 2004. Polycyclic aromatic hydrocarbon migration from creosote-treated railway ties into ballast and adjacent wetlands. Res. Pap. FPL-RP-617. Madison, WI: U.S. Department of Agriculture, Forest Service, Forest Products Laboratory. 53 p.

A limited number of free copies of this publication are available to the public from the Forest Products Laboratory, One Gifford Pinchot Drive, Madison, WI 53726-2398. This publication is also available online at www.fpl.fs.fed.us. Laboratory publications are sent to hundreds of libraries in the United States and elsewhere.

The Forest Products Laboratory is maintained in cooperation with the University of Wisconsin.

The use of trade or firm names in this publication is for reader information and does not imply endorsement by the U.S. Department of Agriculture of any product or service.

The United States Department of Agriculture (USDA) prohibits discrimination in all its programs and activities on the basis of race, color, national origin, sex, religion, age, disability, political beliefs, sexual orientation, or marital or familial status. (Not all prohibited bases apply to all programs.) Persons with disabilities who require alternative means for communication of program information (Braille, large print, audiotape, etc.) should contact the USDA's TARGET Center at (202) 720-2600 (voice and TDD). To file a complaint of discrimination, write USDA, Director, Office of Civil Rights, Room 326-W, Whitten Building, 1400 Independence Avenue, SW, Washington, DC 20250-9410, or call (202) 720-5964 (voice and TDD). USDA is an equal opportunity provider and employer.

Contents

	<i>Page</i>		<i>Page</i>
Background	1	Appendix—Occurrence and Toxicity of PAH in the Environment	34
Introduction	1	Sources of PAH in Aquatic Environments	34
Methods	2	Observed Levels of PAH in Terrestrial Environments ...	35
Mesocosm Site Description	2	Observed Concentrations of PAH in Aquatic Environments	36
Mesocosm Design and Construction	2	Fate of PAH in the Environment	36
Sample Collection, Schedule, and Location	6	PAH From Different Sources	37
Transect Locations and Sample Dates	6	Biological Effects Associated With PAH	41
Sampling Equipment and Protocols	6	Recommended Numerical Benchmarks for Evaluating Environmental Risks Associated with PAH	51
Quality Assurance Requirements	8		
Photographic Record	8		
Data Analysis	8		
Results	9		
Baseline PAH Levels	9		
10-Day Postconstruction PAH Levels	9		
3-Month PAH Levels	9		
6-Month PAH Levels	11		
9-Month PAH Levels	12		
12-Month PAH Levels	12		
15-Month PAH Levels	14		
18-Month PAH Levels	15		
Distribution of TPAH as Function of Depth in Ballast and Sediments at End of Study	16		
Hydrologic Profile and Storm and Groundwater PAH Concentrations	17		
Discussion	18		
Data Quality Assurance	18		
PAH in Ballast	19		
PAH in Wetland Sediments	20		
Summary	23		
Biological Assessment	23		
Conclusions	26		
Recommendations	27		
Literature Cited	27		

Polycyclic Aromatic Hydrocarbon Migration From Creosote-Treated Railway Ties Into Ballast and Adjacent Wetlands

Kenneth M. Brooks, Owner and Principal Scientist
Aquatic Environmental Sciences, Port Townsend, Washington

Background

Creosote has been widely used to protect wood from attack by fungi, marine borers, and insects in the United States since 1865. It is a distillate derived from coal tar produced by the carbonization of bituminous coal. Creosote is a complex mixture of at least 160 detectable hydrocarbon compounds, and all 18 major components are cyclic and aromatic. According to Environment Canada (1992), 80% of creosote is composed of polycyclic aromatic hydrocarbons (PAH). Although PAH occur naturally in the environment, they are potentially harmful to a broad range of organisms (Eisler 1987). Thus, deposition of PAH in the environment may be a concern, especially if endangered species are present.

The preservative treatment of railway ties with creosote is accomplished in accordance with the American Wood-Preservers' Association (AWPA) Standard C2. For durability, most railway ties are cut from hardwoods, particularly red or white oak (*Quercus* spp.). AWPA (1996) requires an average retention of 96 kg creosote per m³ of treated red oak with a minimum penetration depth equal to 65% of the annual rings or to refusal. Because the cells in white oak are filled with tyloses, this species is typically treated to refusal. Treatment to refusal is achieved when no more than 2% additional preservative is taken up by the wood in two consecutive half-hour periods of treatment.

The life expectancies of creosote-treated railway ties depend on rail traffic, tie placement, and environmental hazards. The service life of creosote-treated railway ties is typically 30 years in southern regions, 46 years in eastern regions, and 51 years in western regions of the United States (Zarembski 1990).

Introduction

Commonwealth Edison (Chicago, Illinois) operates a spur railroad line, the Midwest Generation rail line, that crosses the Des Plaines River wetlands in Will County, Illinois. These wetlands are inhabited by the endangered Hines

emerald dragonfly (*Somatochlora hineana*). This rail line, built in the 1950s, has been infrequently used in the last 30 years. In 1996, Commonwealth Edison replaced unserviceable creosote-treated ties supporting the rails with newly treated ties, raising concerns within the U.S. Fish and Wildlife Service that creosote preservative might migrate from ties, through the ballast, and into adjacent wetlands used by the endangered dragonfly. Unfortunately, predicting the amount of creosote that might enter the wetland from the new ties is not possible with the current knowledge base. More information on this subject is needed to make accurate environmental assessments.

One element that confuses the issue is that there are many potential sources of PAH associated with railway rights-of-way (Wan 1991). These include coal and coal dust from cargo entering a coal-fired plant, herbicides used to control vegetation along rights-of-way, diesel exhaust from diesel-electric locomotives, and heated lubricating oils and greases. With all these sources, it is very difficult to determine the specific contribution from creosote-treated railway ties. Coal is a potential source of PAH along the Midwest Generation rail line because this line carries coal into the Will County power station.

This paper reports on a mesocosm study of a simulated rail line running through a wetland. The extent of PAH migration from creosote-treated railway ties into the adjacent environment was examined. A mesocosm design was chosen in an attempt to minimize the other sources of PAH and to focus on those released from new and used creosote-treated railway ties. The mesocosm design is intended to very closely mimic the railway passing through the Des Plaines River wetland of concern. This study analyzed PAH in the ballast, adjacent wetland soils, shallow groundwater, and stormwater at quarterly or annual intervals, depending on the type of railway tie treatment, for 2 years.

Three PAH migration pathways were examined: direct contamination from surface stormwater, infiltration into shallow groundwater and then laterally into the wetland, and lateral movement out of right-of-way ballast.

In this study, weathered, newly treated, and untreated ties were each placed in the wetland mesocosm. Samples were taken of groundwater, stormwater, sediment, ballast rock, and cores. All samples were analyzed for PAH content. Ballast and sediment samples were taken at 10 days, and 3, 6, 9, 12, 15, and 18 months after the ties were placed in the mesocosm.

Methods

Mesocosm Site Description

Several wetland sites were evaluated as potential locations for the mesocosm study. An upland site near the town of Romeoville, Illinois, was chosen where there was minimal potential for overtopping during high water. The chosen site was located in a relatively undisturbed area of Material Service Corporation's property. It lies at an elevation of approximately 8.7 m above the Des Plaines River wetland. The mesocosm soils were originally 504D (Sogn Loam). However, overburden from the Material Service Corporation's gravel quarry of mixed and unknown soil type had been deposited at this site. Wetland soils were excavated with an appropriate Corps of Engineers Section 404 permit. These wetland soils are 316 (Romeo Silty Clay Loam). Soil types are those listed in the Soil Conservation Service Soils Inventory for Will County.

Baseline PAH concentrations were determined in three random surficial soil samples collected at the mesocosm site on May 6, 1997, and submitted to National Environmental Testing (NET) (Bartlett, Illinois) for PAH analysis using U.S. Environmental Protection Agency (EPA) Method 8310 following Soxhlet extraction. Harkey and Young (2000) have suggested that Soxhlet extraction overestimates biological effects because aromatic compounds are released from sediments that would not normally be bioavailable. They recommended a supercritical fluid extraction as more representative of actual toxicity. To be conservative, and in light of its long use, Soxhlet extraction was used throughout these studies. The results for baseline total PAH (TPAH) are summarized in Table 1.

Table 1—Summary report of baseline PAH levels observed in surficial soils taken from the mesocosm study site right before construction. Reported values have been corrected for the surrogate (p-Terphenyl) recovery in each analysis.

Replicate	Detected PAH (µg/g)
1	none
2	0.09
3	0.14
Mean ± 95% CI ^a	0.08 ± 0.17

^aCI, confidence interval.

The mean TPAH value reported from Des Plaines River wetland samples by Brooks (1997b) was 0.833 ± 0.520 µg TPAH/g. The mesocosm was isolated from the underlying soils by an impermeable 6 mil polypropylene liner. This evaluation suggested that there were no significant sources of PAH to this upland site and that it was suitable from this perspective.

Mesocosm Design and Construction

A plan view of the mesocosm is provided in Figure 1 and a cross-sectional view in Figure 2. The Corps of Engineer's permit condition required only a comparison of used railway ties with untreated ties. However, a third mesocosm containing new creosote-treated ties was also constructed. Figure 3 shows the basic excavation at the mesocosm site.

Mesocosm Liners and Subsurface Irrigation System

Each mesocosm was isolated from the native soils with a 6 mil polypropylene liner with welded seams to ensure that PAH in water percolating down through the mesocosm was contained. This allowed for an understanding of the bulk loss of PAH from the railway ties to underlying groundwater. In addition, the impermeable membrane prevented shallow groundwater, or stormwater, from transporting PAH laterally out of the mesocosms. The liner was bedded in sand to prevent underlying rocks from compromising it.

These mesocosms were constructed in upland areas but needed to function as wetlands. The impermeable membrane was incorporated to help retain natural rainfall. However, additional water was made available through an underground delivery system mimicking the groundwater that flows in the Des Plaines River wetland. To accomplish this, the design included a 3.8-kL water tank, supply lines, and float valves to maintain saturation at a level mimicking that found in the wetland adjacent to the Midwest Generation rail line. Each valve floated in its own sump connected to a 51-mm, perforated polyvinyl chloride (PVC) pipe, which extended around the perimeter of the bottom of the mesocosm in contact with the impermeable membrane. Because PVC will absorb PAH, this PVC water distribution pipe was placed on the perimeter of each mesocosm and it did not extend under, or immediately adjacent to, any area that was sampled for PAH. The liner and subsurface irrigation system are shown in Figure 4.

To assist in determining the level of water in the natural wetland adjacent to the actual rail line, a similar sump (constructed of PVC instead of stainless steel) was installed at a distance of 30 cm from the right-of-way. This facilitated determination of natural wetland saturation levels and corresponding adjustment of the float valves in the mesocosms. Water was added to the mesocosms several times during the summer of 1998, and wetland hydrology was maintained during the entire testing period.

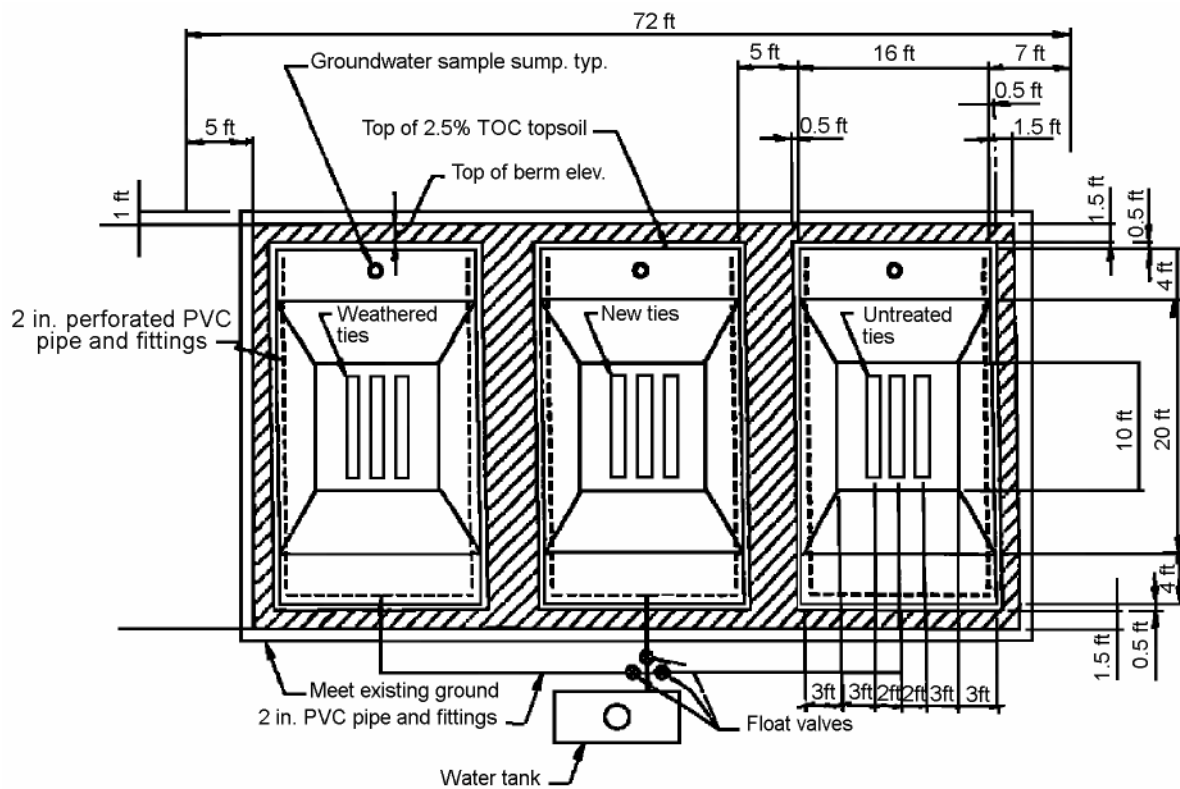

Figure 1—Detailed plan view of the mesocosms (1 in. = 25.4 mm; 1 ft = 0.3 m).

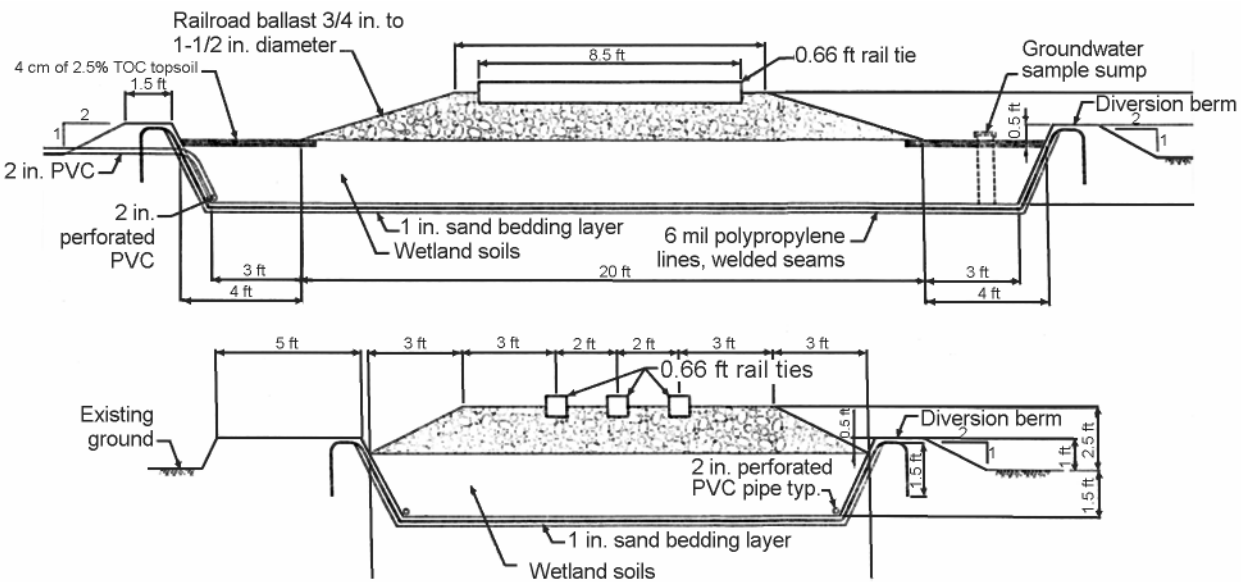

Figure 2—Cross sections of one of three mesocosm compartments (one cross section each direction across mesocosm) (1 in. = 25.4 mm; 1 ft = 0.3 m).



Figure 3—Basic mesocosm excavation.

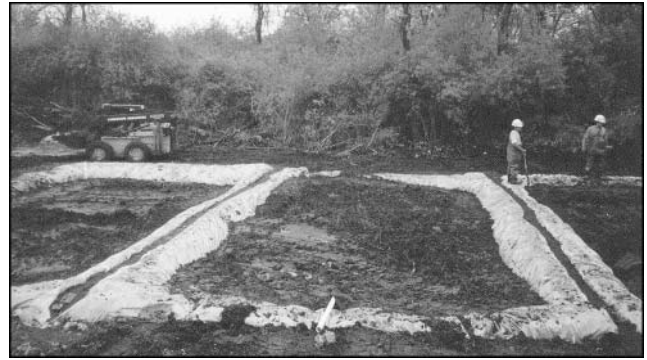

Figure 5—Mesocosms after placement of wetland soils.

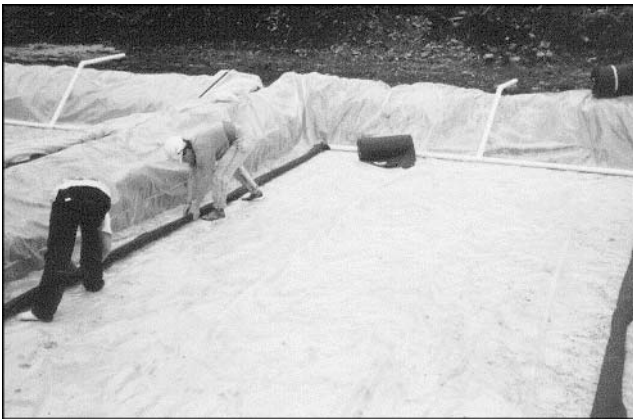

Figure 4—Impermeable liner and subsurface irrigation system installed to maintain and control wetland hydrology.



Figure 6—Mesocosm after placement of broken limestone ballast in an identical configuration with the right-of-way crossing the Des Plaines River wetland.

Placement of Wetland Soils

Following installation of the liner and subsurface irrigation system, each mesocosm was filled to a depth of 60 cm with native wetland soil, excavated from the adjacent area. Figure 5 shows the mesocosms following placement of the wetland soils. Wetland soils were tested for PAH and total organic carbon (TOC) content prior to placement in the mesocosms.

Placement of Limestone Ballast

Broken limestone ballast (19 to 38 mm) was added to the mesocosms from May 12 to 14, 1998, using a tractor-mounted backhoe. Both the backhoe and the dump truck used to transport the ballast to the mesocosm site were thoroughly pressure-washed prior to use. Railway ballast extended to the edges of each subsection, along the length of the mimicked railway, to model the infinitely long aspect of the typical railroad right-of-way. Figure 6 shows the mesocosms following placement of the ballast.

Baseline ballast samples were collected from random locations in each mesocosm just prior to placing the treated crossties. Baseline ballast samples were collected in the untreated tie mesocosm within 1 h of placing the untreated ties. The laboratory conducting the PAH analysis (NET) purchased large Soxhlet extractors allowing retrieval of PAH from ballast of the specified size without further mechanical reduction.

Railway Tie Installation

Newly treated and weathered ties, removed from the Midwest Generation rail line, were installed in two of the mesocosms on May 18, 1998. Untreated hardwood ties, of the same tree species (red oak) were placed in the third mesocosm as a control. The weathered ties were cut to the same length as the new ties and the untreated ties prior to installation. Each mesocosm contained three standard-sized crossties placed in a fashion identical to the actual right of way.



Figure 7—Completed wetland mesocosms.

Table 2—Measured creosote retention for new and old railway ties used in the mesocosm study. Each measurement is the mean of 12 borings.

New ties (kg/m ³)	Old ties (kg/m ³)
44.64	55.52
28	84.96
57.28	39.36

Each tie was identified with a plastic label. Day 0 samples were collected on the day the ties were placed in the ballast. The completed mesocosms are shown in Figure 7.

Actual creosote retentions in randomly selected new ties were determined by Kerr McGee (Oklahoma City, Oklahoma), the producer of the newly treated ties. Used ties, previously taken out of service and stored at Commonwealth Edison were assayed for retention on site by personnel from Kerr McGee. Twelve 7.6-cm-long cores were taken from each tie (three per longitudinal surface). The target retention specified by AWWA Standard C6 (AWWA 1996) for oak crossties is 112 kg/m³ or treatment to refusal. Oak is a difficult to treat hardwood, and ties are usually treated to refusal. The actual retentions measured in new and old ties are provided in Table 2.

The mean retention for the three new ties (43 kg/m³) was less than the mean for the three old ties (60 kg/m³), but the differences were not statistically significant ($\alpha = 0.05$ ($t_{crit} = 2.78$ and $t_{calc} = 1.09$)).

Vegetation Management

The area where wetland soils were acquired was covered with reed canary grass (*Phalaris arundinacea*), which is aggressively invasive. It was important to minimize introduction of this species into the mesocosm because the additional organic matter contributed by a heavy growth of reed canary grass would greatly complicate the measurement of TOC and PAH. In addition, the hardy roots would bind the

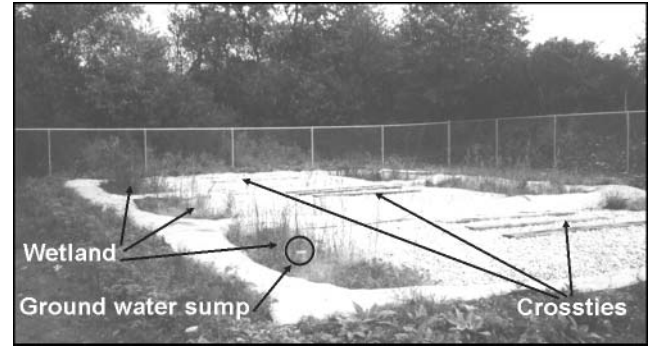

Figure 8—Mesocosm study site in the fall of 1998, approximately 6 months following construction.

Table 3—Number of plant species and wetness values observed in mesocosms containing new and weathered creosote-treated ties and untreated red oak ties.

Mesocosm	Number of plant species	Overall average value of wetness ^a
Untreated red oak ties	24	-0.9
Newly treated creosote ties	38	-1.0
Weathered creosote ties	28	-1.0

^aWetness values range from obligate wetland species (-5) to obligate upland species (5).

wetland soils, making sampling difficult. The native wetland soils were scalped to a depth sufficient to exclude any viable roots of this plant (30 to 40 cm). Wetland vegetation did grow in the mesocosm during 1998. However, the plant community did not include reed canary grass and it did not become heavy enough to warrant the use of an herbicide. Following completion of all construction, a 2-m-high chain-link fence, equipped with a locked gate, was installed around the mesocosm to enhance security. Figure 8 shows the mesocosms in the fall of 1998.

Volunteer Mesocosm Vegetation

Mesocosm vegetation was inventoried by Christopher B. Burke Engineering Ltd. (CBBEL, Rosemont, Illinois) on June 29, 1999. Vegetation grew in the wetland areas of the mesocosm located on either side of the ballast. The plants growing within each cell were identified and assigned wetland indicator values (*W*). These values range from *W* = -5, indicative of obligate wetland species occurring in wetlands with a probability of >99% to *W* = 5, representing species that are obligate upland species with a probability of being found in wetland areas of <1%. Wetland indicator values were those given in Swink and Wilhelm (1994). The results of this inventory are summarized in Table 3.

No attempt was made in this report to analyze the vegetation data provided by CBBEL and Swink and Wilhelm (1994). It is apparent that the hydrology created and maintained in these mesocosms was able to sustain a community of plants that included many obligate wetland species and that on average would meet the requirements of a regulated wetland. The number of different plant species and wetness factors observed in the mesocosms containing creosote-treated railway ties exceeded that observed in the untreated tie mesocosm. This suggests that the presence of creosote-treated ties in the ballast did not adversely affect the plant community. However, no quantitative assessment was attempted and none should be inferred.

Groundwater Sampling

Groundwater sampling was attempted through a 15-cm-diameter stainless steel sump installed at full depth in the wetland soils. The sump was covered with a stainless steel cover when not in use. The bottom of the sump had four orthogonal holes, each 5.0 cm in diameter, that were screened with 500- μ m stainless steel screens. The sump was located on the opposite side of the mesocosm from the wetland water delivery system. No perforated PVC pipes were located in the vicinity of the sump. The tops of these sumps can be seen in Figure 8.

Water did not migrate vertically in these Des Plaines River wetland soils, and the sumps collected insufficient amounts of water for sampling during this study, even though the soils remained saturated during the entire study and wetland portions of the mesocosms were periodically inundated during heavy rainfall. Beginning in the summer of 1998, stormwater was collected in deep glass beakers inserted into the wetland soils with their tops flush with the surrounding wetland soils.

Construction Notes

All excavation, transportation of construction materials, and other mesocosm work was accomplished using equipment that had been thoroughly pressure-washed and checked for oil and hydraulic leaks prior to use. All equipment was serviced at a minimum distance of 30 m from the mesocosm. All nonessential hydrocarbons, not part of the design, were kept a minimum of 30 m from the mesocosm.

Approximately 0.4 m³ of additional ballast was set aside, inside the fenced area, and covered with a tarp. This additional ballast rock was used to replace that taken from the mesocosms during sampling. Likewise, approximately 0.1 m³ of wetland soil was set aside to replace surficial wetland soils removed during sampling. The sampling schedule is designed so as not to sample in the same location twice. However, it was important to maintain the geomorphology of the mesocosms' surface throughout the study, and therefore, replacement of sampling material was necessary.

Each mesocosm was identified by a sign, located on the outside edge of the sampling area, designating it as either new tie, weathered tie, or untreated tie.

Sample Collection, Schedule, and Location

Stormwater

Three stormwater samples from the untreated mesocosm and five samples each from the newly treated and weathered tie mesocosms were collected during this study to evaluate the migration of PAH from ballast in surface flows using gas chromatography/mass spectroscopy (GC/MS) (EPA 2003a). A total of 13 stormwater samples were analyzed for PAH.

Sediment

Samples for PAH analysis in mesocosm wetland soils at distances of 0.0, 0.25, 0.50, and 0.75 m from the edge of the ballast along three transects (one transect adjacent to each tie) (high-pressure liquid chromatography (HPLC); EPA 2003b). In total, 229 surficial wetland sediment samples (upper 2 cm) were collected and analyzed for PAH analysis.

Ballast Rock

Ballast rock was collected for PAH analysis at distances of 5, 20, and 30 cm from the east or west face of each tie (HPLC; Modified EPA Method 8310). In total, 174 ballast samples were collected and analyzed from the surface of the mesocosms.

Core Samples

Core samples were collected at 10-cm increments to the full depth of the ballast and wetland sediments at the end of the study. These core sections were analyzed individually for PAH to determine the potential for vertical migration (HPLC; EPA Method 8310). In each mesocosm, 36 ballast core samples were collected from two locations, and 11 wetland sediment core samples were collected from the edge of the ballast in the new tie mesocosm.

Transect Locations and Sample Dates

The position of transects for each sampling period is provided in Table 4 along with the date on which samples were collected. Transect positions are relative to either the east end of individual railway ties or to the south end of the simulated railway line in each mesocosm. These relationships are shown in Figure 9.

Sampling Equipment and Protocols

Gloves and Booties

New latex gloves and synthetic booties were worn for all sampling except the final event. A single pair of booties were dedicated to each mesocosm. A new pair of gloves was worn for each transect.

Table 4—Transect location in centimeters from the origin described in Figure 9

Sample event	Untreated tie	Weathered tie	New tie	Wetland
Baseline (5/18/98)	N40/N120/N80	N0/S80/S160	S200/S60/S120	E20/E110/W80
Post construction (5/28/98)	S20/N60/N240	N100/S60/N240	N90/S240/S180	W120/W60/W20
Quarter 2 (8/18/98)	N160/S100/S200	S100/S180/N40	N0/S140/N220	E40/W50/E30
Quarter 3 (11/18/98)	S0/N200/S160	N140/N60/S240	N40/N200/N80	E10/E90/E100
Quarter 4 (2/18/99)	N20/N240/S180	S140/N180/N80	S0/S160/N140	E70/W70/W30
Quarter 5 (5/24/99)	S120/S140/N180	N20/S20/S120	S80/S160/N240	W130/W90/W10
Quarter 6 (8/24/99)	N0/S220/S80	S200/N160/N220	N100/S20/S100	E140/E60/W100
Quarter 7 (11/24/99)	N220/N110/N60	N120/S0/S40	N120/N180/N60	E120/E50/E130

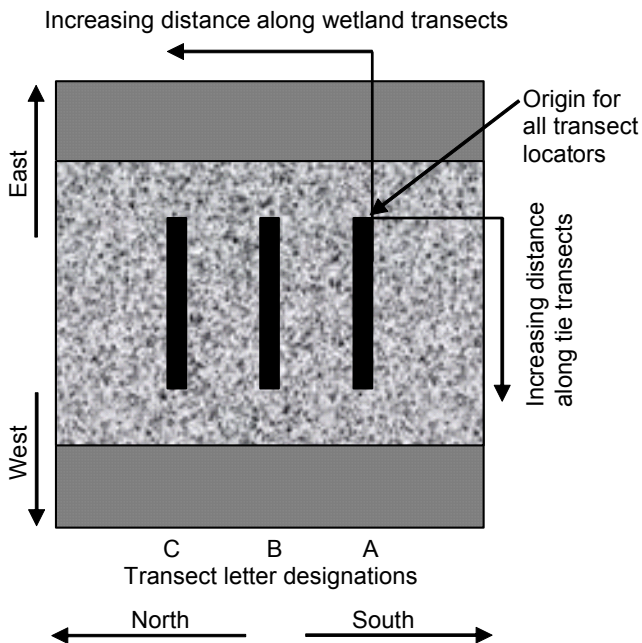

Figure 9—Location of randomly chosen transects for the mesocosm study. Three numbers are provided for each date and mesocosm, corresponding to each of the three transects. The letter N or S, associated with the tie transects, refers to the north or south face of the tie. Likewise, the E or W letter associated with wetland transects refers to the east or west side of the mesocosm.

Sample Site Access

Clean wooden planks (one for each mesocosm) were used to span the wetland soils located between the ballast and the mesocosm's berm. Any disturbance could redistribute accumulating PAH, confounding the results. All human trespass was avoided in the simulated wetland areas. The entire mesocosm was protected with a cyclone fence and locked gate.

Sediment Sample Containers

Sediment sample containers for PAH analysis were made of glass and held 500 mL of wetland soil. Larger, 2-L wide-mouth glass containers were used for the ballast rock. All sample containers were washed with a phosphate-free detergent solution, followed by a thorough rinse with hot tap water and analyte-free water. This was followed by an acetone rinse and a final rinse using high-purity methylene chloride. Lids were placed on the sample containers during the final rinse step. Firing of glass containers at approximately 350°C for 4 h was allowed as a substitute for the final solvent rinse only if precautions were taken to avoid contamination as the container was dried and cooled.

Water Sample Containers

Water sample containers for PAH analysis were made of glass and held a minimum sample size of 1 L. Containers were precleaned as described for sediment sampling equipment.

Sample Containers for Total Organic Carbon and Sediment Grain Size

Sample containers for TOC and sediment grain size analysis were made of either glass or low-density polyethylene. They were first washed with a phosphate-free detergent solution, followed by a thorough rinse with hot tap water and analyte-free water.

Wetland Sediment Sampling Equipment

Wetland sediment sampling equipment was constructed of stainless steel. A separate spatula was used for each transect (nine required). These spatulas were precleaned with a phosphate-free detergent solution, followed by a thorough rinse with hot tap water and analyte-free water. Before use, equipment was rinsed with solvent (acetone, hexane, or methanol) and air-dried. The spatulas were transported into the field in sealed polyethylene bags. Samples were taken in order of least anticipated contamination (furthest from the ballast to closest to the ballast), and field cleaning was not required.

Ballast Sediment Sampling Equipment

Stainless steel tongs, one for each transect, were precleaned and transported as described for wetland sediment sampling equipment.

Stormwater and Groundwater Sampling

A field (battery-operated) peristaltic pump was used for all water sampling. All tubing, excepting a short section of tubing for the pump was made of Teflon (Dupont Corp., Wilmington, Delaware) or glass. Glass was recommended because it is easy to clean, using the same procedures as described for sediment sample containers. Separate tubing was used for each mesocosm groundwater sample (three required) or for each stormwater sample (three required). Replicate samples within the same mesocosm were obtained using the same tubing.

Sample Documentation and Handling

Samples were tightly capped in prelabeled bottles and stored on ice in the field. Samples were kept at <4°C until arrival at the analytical laboratory. Water samples for PAH analysis were held at 4°C for a maximum of 7 days prior to analysis. Sediment samples for PAH analysis were held for a maximum of 14 days at 4°C. Longer holding times, such as for archiving samples or sample residues, required freezing at <-18°C. Frozen samples can be held for one or more years before extraction. Extracted samples should be analyzed within 40 days (PSWQA 1996).

Testing Laboratory

National Environmental Testing is an Illinois State accredited laboratory, and they proposed the special detection limits for this study. All of the detection limits provided by NET were less than, or equal to, the recommended detection limits provided in PSWQA (1996) for the Puget Sound Ambient Monitoring Program Marine Sediment Monitoring Task (0.020 to 0.100 µg/g).

Quality Assurance Requirements

The following quality assurance (QA) program was required according to Brooks (1997c) for each batch of samples (batches not to exceed 20 samples).

PAH Analysis

The following QA tests and data qualification criteria were stipulated for PAH analysis. Most of these QA requirements could be met using standard protocols. However, the matrix spike of ballast (2- to 4-cm stones) is an unusual requirement. National Environmental Testing verified their extraction procedures for ballast using spiked samples prior to evaluating samples collected from the mesocosms during the baseline evaluation.

Total Organic Carbon

One certified reference material standard was required per survey. Five percent of the samples or a minimum of one sample was required to be run in triplicate, and one blank sample was required at the same interval.

Sediment Grain Size Analyses

Triplicate samples were conducted on one, or a minimum of 5%, of the samples. The root square deviation was ≤20% for these triplicate samples.

Field

One randomly chosen field replicate for groundwater sampling in each mesocosm and one random field replicate for the wetland soil sampling were required during each sample period. No field replicates were collected for the ballast samples because this would require too many sample locations, resulting in resampling of the same location during the study. Container blanks, field blanks, preservation blanks, rinsate blanks, and trip blanks were not required for this study. A temperature blank was included in each cooler, and the temperature of the cooler was determined on receipt at NET.

Chain of Custody

Chain of custody procedures complied with American Society for Testing and Materials (ASTM) D4840–88.

QA requirement	Data qualifier criteria
Method blank (1 per batch)	None detected in blanks
Replicates (1 per batch)	≤100% relative percentage difference
Matrix spike (1 per batch)	50% to 150% matrix spike recovery
Surrogate in all samples and QA samples	±95% confidence interval

Photographic Record

A photographic record of the project was created. Specific photographic requirements were defined in the study protocols.

Data Analysis

The experimental design used in this study includes sufficient replicates to enable statistical tests of the difference between samples collected at control (untreated ties) and treatment (new and weathered tie) sites. The design is such that statistical significance can be examined using either regression analysis of values at varying distances along transects, *t*-tests, or analysis of variance (ANOVA).

Results

Baseline PAH Levels

Before the mesocosms were constructed, nine random samples of wetland soil were collected and composited in three samples that were analyzed by NET for total volatile solids (TVS), TOC, and 16 EPA priority PAH. Polycyclic aromatic hydrocarbons were not observed above the method detection limits in any of these samples. The sum of half the detection limit for each compound was 0.257 ± 0.026 μg TPAH/g dry sediment weight. Total organic carbon was measured at $24.6 \pm 9.7\%$. These TOC values are suspect because TVS were measured at $18.3 \pm 3.0\%$ and TOC is normally about 60% of TVS. In either case, these wetland soils have high organic carbon content that will bind PAH released from the railway ties. Nine subsamples of this material were analyzed for TVS by Aquatic Environmental Sciences (Port Townsend, Washington) at the end of the study. The percentage TVS varied between 14.19% and 21.32% suggesting a range in TOC of 8.5% to 12.8%. The mean TOC value of 11.9% is typical of organic soils found in wetlands.

Ballast

Polycyclic aromatic hydrocarbons were not observed above the method detection limits in any of the ballast samples. The sum of the detection limits for all 16 PAH was 0.51 μg TPAH/g dry ballast.

Wetland Soils

Polycyclic aromatic hydrocarbons were observed above detection limits in five of six baseline wetland soil samples. Total PAH concentrations ranged from 0.183 to 0.893 μg TPAH/g dry soil with a mean and 95% confidence interval of 0.430 ± 0.183 . These values are within the range of values reported by Brooks (1997b) for reference sediments in the River South PAH study (0.833 ± 0.520).

Surrogate Recovery

Analysis of the rocks comprising ballast was accomplished using a protocol developed by Aquatic Environmental Sciences and NET. Surrogate (p-Terphenyl) recovery was excellent for ballast samples analyzed to date with a mean recovery of 93.8%, median of 98.1%, and a range of 56% to 122%. These results are more consistent than surrogate recovery in the wetland soils that averaged 81.2% with a median of 90.2% and a range of 11.5% to 119.5%. The surrogate compound was masked in 3 of 45 (7%) ballast samples and 22% of wetland soil samples. Analytical results have not been corrected for surrogate recovery. This would have required invoking uncertain assumptions regarding the corrections to be applied to the samples in which surrogate recovery was masked.

10-Day Postconstruction PAH Levels

Replicate ballast and sediment samples were collected from each mesocosm to determine PAH levels 10 days following completion of construction.

Ballast

Significant increases in PAH concentrations were not observed in the untreated wooden tie mesocosm 10 days following tie placement. Low levels of PAH were observed in all ballast samples adjacent to creosote-treated wood ties (Table 5). The PAH clines, particularly in ballast next to the newly treated railway ties, suggest that the source of the PAH was in fact the ties. This observation is further supported by the lack of PAH observed in ballast adjacent to untreated wooden ties. Furthermore, it appeared that more PAH had migrated from the newly treated ties into adjacent ballast than from the weathered ties. However, the high variance to mean ratios suggested that the distribution of PAH was very patchy.

Wetland Sediments

Wetland sediments were sampled at 0.0, 25, 50, and 75 cm from the toe of the ballast 10 days after construction (Table 6). Excepting a single high sample at the closest distance (0.0 cm) in the weathered tie mesocosm, significant increases in wetland sediment PAH concentrations were not observed.

The single high sample collected from the weathered tie mesocosm sediments (11.2 μg TPAH/g dry sediment weight) did not contain a PAH profile consistent with creosote. Polycyclic aromatic hydrocarbon profiles in ballast were high in acenaphthene, fluoranthene, fluorene, phenanthrene, and pyrene—a mixture consistent with creosote following treatment. The sediment sample in question consisted mainly of high molecular weight (HMW) compounds including benzo(a)anthracene, benzo(a)pyrene, benzo(ghi)perylene, chrysene, and pyrene. This profile is more characteristic of creosote contamination that has weathered for many years or of another PAH source. Other than the single elevated sample, PAH did not appear to be migrating from the ballast into the wetland.

3-Month PAH Levels

Replicate samples were collected from ballast and sediments in the newly treated and untreated railway tie mesocosms 3 months after placement of the ties. Samples were not collected in the weathered tie mesocosm at this time.

Ballast

Concentrations of PAH were elevated (814.7 μg TPAH/g dry ballast) in a single ballast sample collected immediately adjacent (5.0 cm station) to an untreated railway tie. There is no source of PAH in the untreated tie mesocosm and this result suggests that care must be exercised when evaluating

Table 5—Concentrations of PAH observed in railway right-of-way ballast at distances of 5, 20, and 30 cm from new and weathered creosote-treated railway ties and untreated ties 10 days following tie placement. The detection limit was used as a minimum value for each compound

Mesocosm	Distance (cm)	Mean TPAH ($\mu\text{g/g}$)	95% confidence
Untreated	5	0.153	0.014
Untreated	20	0.173	0.052
Untreated	30	0.153	0.014
New	5	2.498	1.931
New	20	1.330	1.179
New	30	0.578	0.332
Weathered	5	0.668	1.605
Weathered	20	0.175	0.483
Weathered	30	0.358	2.502

Table 6—Concentrations of PAH observed in wetland sediments at distances of 0, 25, 50, and 75 cm from the toe of right-of-way ballast in mesocosms containing newly treated, weathered, and untreated railway ties. Samples were collected 10 days following completion of construction. The detection limit was used as a minimum value for each compound

Mesocosm	Distance (cm)	Mean TPAH ($\mu\text{g/g}$)	$\pm 95\%$ confidence
Weathered	0	3.964	7.065
Weathered	25	1.108	1.549
Weathered	50	0.378	0.132
Weathered	75	0.274	0.012
Untreated	0	0.292	0.024
Untreated	25	0.325	0.022
Untreated	50	0.425	0.290
New	75	0.314	0.029
New	0	0.727	0.722
New	25	0.456	0.050
New	50	0.376	0.171
New	75	0.319	0.085

the meaning of a single high result in replicated PAH studies.

All 10 ballast samples collected from the area adjacent to the newly treated ties contained elevated levels of PAH with a profile characteristic of creosote. These values ranged from 80 to 1,984 μg TPAH/g dry ballast weight. Creosote was clearly migrating from the ties into the adjacent crushed limestone rock ballast (Table 7). The variance to mean ratios in those samples where PAH was detected were >1.0 , indicating a very patchy PAH distribution. This distribution is consistent with the particulate PAH transport hypothesis developed by Goyette and Brooks (1999).

Table 7—Concentrations of PAH observed in railway right-of-way ballast at distances of 5, 20, and 30 cm from new creosote-treated railway ties and untreated ties 3 months following tie placement. The detection limit was used as a minimum value for each compound

Mesocosm	Distance (cm)	Mean TPAH ($\mu\text{g/g}$)	SD	$\pm 95\%$ confidence
Untreated	5	271.6	470.4	532.3
Untreated	20	0.0	0.0	0.000
Untreated	30	0.0	0.0	0.000
New	5	942.3	907.4	1,026.8
New	20	1,052.1	683.0	772.9
New	30	373.0	325.7	368.6

Table 8—Concentrations of PAH observed in mesocosm wetland sediments at distances of 0, 50, and 75 cm from new and weathered creosote-treated railway ties and untreated ties 3 months following tie placement. The detection limit was used as a minimum value for each compound

Mesocosm	Distance (cm)	Mean TPAH ($\mu\text{g/g}$)	SD	95% confidence
Untreated	0	0.356	0.057	0.065
Untreated	50	0.744	0.851	0.963
Untreated	75	0.366	0.120	0.136
Weathered	0	0.712	0.168	0.190
Weathered	50	6.743 (0.320)	10.8 (0.247)	12.248 (0.280)
Weathered	75	0.534	0.506	0.572
New	0	0.444	0.168	0.190
New	50	0.743	0.413	0.467
New	75	0.407	0.065	0.074

Wetland Sediments

Similar to the first sampling period, a single high sample (19.2 μg TPAH/g dry sediment) was collected 50 cm from the toe of the ballast in the weathered tie mesocosm. Elevated PAH concentrations were not observed in other wetland sediments. The other two samples collected at 50 cm in the weathered tie mesocosm were low (≈ 0.3 $\mu\text{g/g}$). In addition, like the previous sample, this one was also rich in HMW compounds and contained low concentrations of those compounds characteristic of creosote, particularly phenanthrene and fluoranthene, which were not observed above the detection limits. However, the detection limits were very high in this sample, further confounding the analysis. When this sample is excluded from the analysis, the results (provided in parentheses in Table 8) indicate no movement of PAH from the right-of-way into the wetland environment during the first 3 months following construction.

Table 9—Concentrations of PAH observed in railway right-of-way ballast at distances of 5, 20, and 30 cm from new and weathered creosote-treated railway ties and untreated ties 6 months following tie placement. The detection limit was used as a minimum value for each compound

Mesocosm	Distance (cm)	Mean TPAH (µg/g)	SD	95% confidence
Untreated	5	0.661	1.145	1.295
Untreated	20	0.000	0.000	0.000
Untreated	30	0.000	0.000	0.000
New	5	54.561	80.740	91.364
New	20	32.928	50.529	57.178
New	30	8.782	3.218	3.641
Weathered	5	1.082	1.874	2.121
Weathered	20	0.088	0.152	0.172
Weathered	30	1.489	2.578	2.918

6-Month PAH Levels

Replicate samples were collected from ballast in the newly treated and untreated railway tie mesocosms and from sediments in all three mesocosms 6 months after placement of the ties (Table 9).

Ballast

Polycyclic aromatic hydrocarbons were observed in a single ballast sample collected 5 cm from a tie in the untreated mesocosm. However, the mean TPAH concentration in the untreated tie mesocosm ballast was not significantly different ($\alpha = 0.05$) than observed in reference area sediments from the Des Plaines River wetland.

All nine ballast samples collected from the area adjacent to the newly treated ties contained elevated levels of PAH with a profile characteristic of creosote. These values declined from a high of 54.6 mg/kg dry weight immediately adjacent to the tie (5.0 cm) to 32.9 mg/kg at 20 cm and 8.8 mg/kg at 30 cm from the newly treated ties. Creosote was clearly migrating from these ties into the adjacent ballast. Total PAH concentrations observed in the weathered tie mesocosm were lower than those observed in the new tie mesocosm but were significantly higher than observed in the untreated tie mesocosm.

The variance to mean ratios in those samples where PAH was significantly elevated were >1.0 , indicating a patchy distribution. This is shown in Figure 10, which provides box and whisker plots (mean \pm 1.0 and 1.96 standard errors of the mean) for the data as a function of both distance and treatment. Analysis of variance indicates that differences between the treatments were marginally significant ($p = 0.0518$). Post hoc testing using Duncan's test with multiple ranges indicates that TPAH concentrations in the new tie mesocosm ballast were significantly higher than in either the weathered tie ($p = 0.036$) or the untreated tie ($p = 0.041$) mesocosms but that TPAH concentrations in the weathered tie and untreated tie mesocosms were not significantly different at $\alpha = 0.05$ ($p = 0.963$). Differences in TPAH concentrations were not significantly a function of distance ($p = 0.62$). This is because single high TPAH concentrations were observed at distances of 5 and 20 cm from the face of one newly treated tie 6 months after placement of the ties.

Wetland Sediments

Wetland sediment concentrations of polycyclic aromatic hydrocarbons observed 6 months after placement of the ties, are summarized in Table 10. No sample was significantly elevated above Des Plaines River baseline PAH levels.

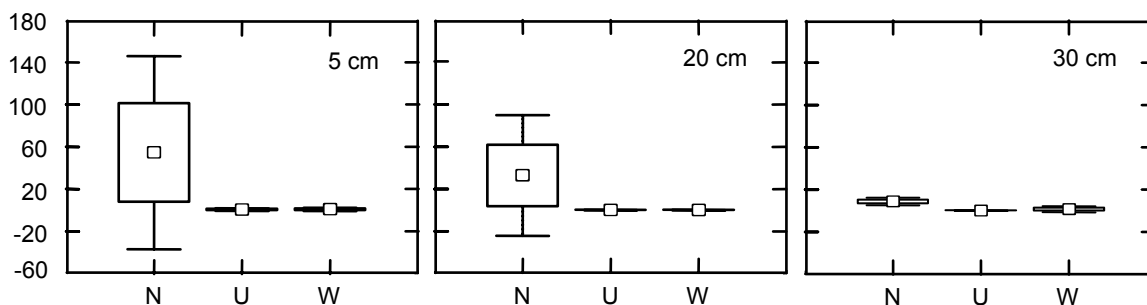

Figure 10—Box and whisker plots describing the concentrations of all PAH observed in ballast rocks at distances of 5.0, 20.0, and 30.0 cm from the faces of newly treated railway ties (N), untreated railway ties (U), and weathered creosote-treated ties (W) in the mesocosm study. These data were collected 6 months after placement of the ties.

Table 10—Concentrations of PAH observed in mesocosm wetland sediments at distances of 0, 50, and 75 cm from new and weathered creosote-treated ties and untreated ties 6 months following placement of the ties. The detection limit was used as a minimum value for each compound

Mesocosm	Distance (cm)	Mean TPAH (µg/g)	SD	95% confidence
Untreated	0	0.476	0.257	0.675
Untreated	50	0.438	0.127	0.030
Untreated	75	0.542	0.300	0.239
New	0	0.581	0.204	0.291
New	50	0.434	0.097	0.144
New	75	0.335	0.017	0.339
Weathered	0	0.708	0.597	0.675
Weathered	50	0.363	0.026	0.030
Weathered	75	0.399	0.211	0.239

treatments or distances. The null hypothesis that wetland sediment PAH concentrations were equal in all treatments and/or at all distances was not rejected at $\alpha = 0.05$. There is no evidence in the 27 sediment samples collected at 6 months that polycyclic aromatic hydrocarbons were moving from the ballast into the adjacent wetland.

9-Month PAH Levels

Nine months after tie placement, three replicates of ballast rock were collected from each of three distances located 5, 20, and 30 cm from the face of untreated and newly treated ties. In addition, three replicate wetland soil samples were collected in each mesocosm at distances of 0.0, 25, 50, and 75 cm from the toe of the ballast carrying the ties.

Ballast

Polycyclic aromatic hydrocarbon concentrations in ballast rock continued to decline rapidly between 6 and 9 months after tie placement (Table 11). The variance to mean ratios in the untreated mesocosm were all <1 suggesting an even distribution of PAH consistent with atmospheric deposition. In contrast, the variance to mean ratios in the two ballast stations closest to the newly treated ties (5 and 20 cm) were approximately 2.0, indicating a moderately patchy distribution. The distribution of individual PAH at the five elevated stations in the newly treated tie mesocosm remained high in phenanthrene and fluoranthene with only minor contributions from the HMW compounds. The results for TPAH in ballast rock are summarized in Table 11 and Figure 11. The concentration of TPAH observed in the newly treated tie mesocosm had declined from a mean of 789 µg TPAH/g dry ballast at 3 months to 1.598 µg TPAH/g dry sediment at 9 months.

Table 11—Concentrations of PAH observed in railway right-of-way ballast at distances of 5, 20, and 30 cm from new creosote-treated railway ties and untreated ties 9 months following tie placement. Each value is the mean of three replicates. The detection limit was used as a minimum value for each compound

Mesocosm	Distance (cm)	Mean TPAH (µg/g)	SD	Variance
Untreated	5	0.313	0.165	0.000
Untreated	20	0.307	0.005	0.000
Untreated	30	0.301	0.000	0.000
New	5	1.974	2.124	4.512
New	20	1.950	1.426	2.034
New	30	0.872	0.466	0.218

Wetland Sediments

One replicate at the 75-cm station in the new tie mesocosm was excluded from the analysis. Detection limits in this sample were exceptionally high, ranging from 0.75 to 3.4 µg PAH/g dry sediment. Compounds typical of creosote were not detected but benzo(a)anthracene, benzo(b)fluoranthene, benzo(a)pyrene, chrysene, and pyrene were. The TPAH (including the value of the detection limit where PAH were not detected) was 75.8 µg/g. The TPAH for the other two replicates at this distance in this mesocosm on this date were 0.64 and 0.78 µg TPAH/g. The sample was deleted because of the abnormally high detection limits, because compounds associated with creosote were not detected, and because the compounds detected were not typical of creosote. Summary statistics for PAH in the remaining sediment samples are provided in Table 12. Variance to mean ratios were all less than one, suggesting a rather uniform PAH distribution. Analysis of variance indicated that the null hypothesis (that all means were equal as a function of distance or treatment) was not rejected with $p = 0.88$. These results suggest that PAH had not migrated from the ballast into adjacent wetland sediments up to this point in the study. The observed means are similar to those reported by Brooks (1997b) for River South reference sediments (0.833 µg TPAH/g dry sediment).

12-Month PAH Levels

Ballast

Fluoranthene, phenanthrene, chrysene, and pyrene were detected at low levels in 6 of 27 ballast samples 12 months after tie placement. These compounds are characteristic of creosote. No sample was excluded for QA reasons on this date. The results are summarized in Table 13. The variance to mean ratios were all <1.0, suggesting a homogeneous distribution of the PAH. That is, in part, because detection limits were used where PAH was not detected. The null hypothesis that ballast concentrations of PAH were equal in all treatment and at all distances was not rejected ($\alpha = 0.05$ (ANOVA, $F = 1.72$, $p = 0.16$)).

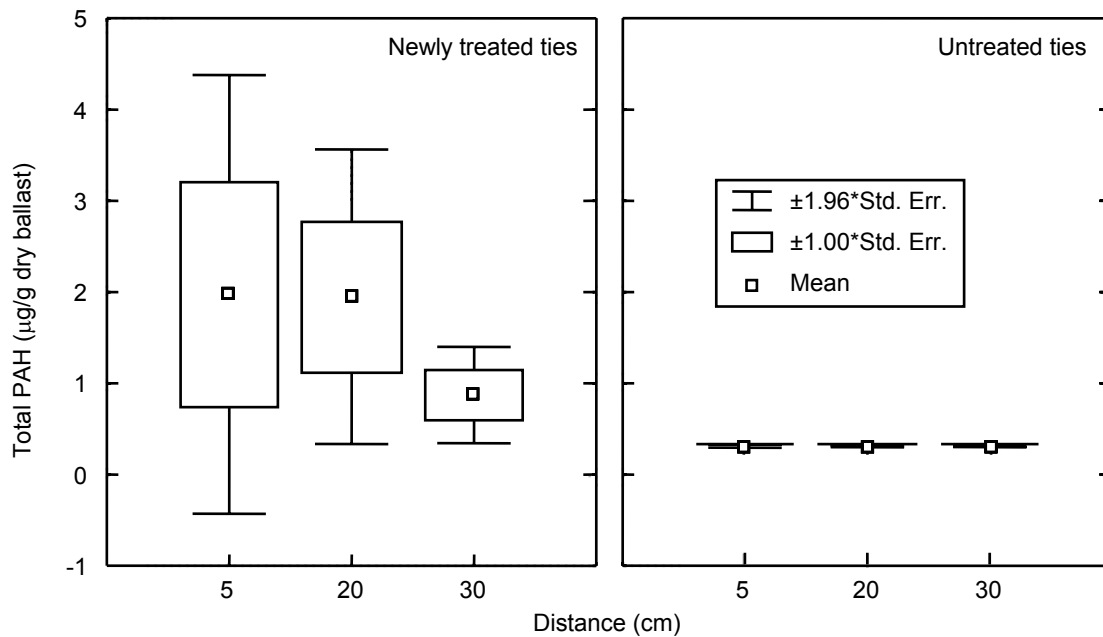

Figure 11—Box and whisker plots describing the concentrations of all PAH observed in ballast rocks at distances of 5.0, 20.0, and 30.0 cm from the faces of newly treated railway ties (N) and untreated railway ties (U) in the mesocosm study. These data were collected 9 months after placement of the ties.

Table 12—Concentrations of PAH observed in mesocosm wetland sediments at distances of 0, 25, 50, and 75 cm from new and weathered creosote-treated ties and from untreated ties 9 months following placement of the ties. The detection limit was used as a minimum value for each compound

Mesocosm	Distance (cm)	Mean TPAH (µg/g)	SD	95% confidence
Untreated	0	0.797	0.183	0.033
Untreated	25	0.756	0.124	0.015
Untreated	50	0.687	0.081	0.007
Untreated	75	0.702	0.018	0.000
New	0	0.789	0.340	0.116
New	25	0.724	0.058	0.003
New	50	0.658	0.078	0.006
New	75	0.694	0.077	0.006
Weathered	0	0.795	0.380	0.144
Weathered	25	0.760	0.352	0.124
Weathered	50	1.046	0.557	0.310
Weathered	75	0.934	0.270	0.073

Table 13—Concentrations of PAH observed in railway right-of-way ballast at distances of 5, 20, and 30 cm from new and weathered creosote-treated railway ties and untreated ties 12 months following tie placement. Each value is the mean of three replicates. The detection limit was used as a minimum value for each compound

Mesocosm	Distance (cm)	Mean TPAH (µg/g)	SD	Variance
Untreated	5	0.640	0.000	0.000
Untreated	20	0.640	0.000	0.000
Untreated	30	0.735	0.164	0.027
New	5	1.024	0.437	0.191
New	20	0.643	0.005	0.000
New	30	0.672	0.027	0.001
Weathered	5	0.640	0.000	0.000
Weathered	20	0.640	0.000	0.000
Weathered	30	0.735	0.183	0.027

Table 14—Concentrations of PAH observed in mesocosm wetland sediments at distances of 0, 25, 50, and 75 cm from new and weathered creosote-treated ties and from untreated ties 12 months following placement of the ties. The detection limit was used as a minimum value for each compound

Mesocosm	Distance (cm)	Mean TPAH (µg/g)	SD	95% confidence
Untreated	0	4.160	3.487	12.160
Untreated	25	4.213	3.699	13.679
Untreated	50	1.520	0.215	0.046
Untreated	75	1.347	0.220	0.049
New	0	1.136	0.147	0.022
New	25	1.439	0.464	0.215
New	50	1.610	0.646	0.417
New	75	1.319	0.287	0.082
Weathered	0	1.503	0.203	0.041
Weathered	25	1.187	0.049	0.002
Weathered	50	1.313	0.159	0.025
Weathered	75	1.232	0.097	0.009

Wetland Sediments

Table 14 summarizes PAH concentrations observed in sediments at 12 months after placement of the ties. The elevated PAH concentrations observed in sediments from the untreated mesocosm must be interpreted with caution. They are associated with moderately high detection limits (0.075 to 0.530 µg PAH/g) created by low solids in the samples. Only fluoranthene was actually detected at a concentration of 0.100 µg/g in the 12 samples collected in this mesocosm. Phenanthrene and benzo(ghi)perylene were detected at low levels in sediments from the new tie mesocosm. Only phenanthrene was consistently detected at low concentrations in the weathered tie mesocosm. These data suggest that low levels of PAH have migrated from the ballast into adjacent wetlands. As will be discussed in a later section, the observed PAH concentrations are below those associated with any biological effects and the highest TPAH concentrations were observed in the untreated tie mesocosm where there is no known source of PAH, other than atmospheric deposition.

15-Month PAH Levels

A single sediment sample from the weathered tie mesocosm was excluded from the analysis on this date. The exclusion was based on high detection limits (1.6 µg PAH/g for all compounds). The only compounds detected were benzo(b)fluoranthene and benzo(k)fluoranthene. Because of the absence of phenanthrene, fluoranthene, and other intermediate-weight PAH compounds associated with

Table 15—Concentrations of PAH observed in railway right-of-way ballast at distances of 5, 20, and 30 cm from new and weathered creosote-treated railway ties and untreated ties 12 months following tie placement. Each value is the mean of three replicates. The detection limit was used as a minimum value for each compound

Mesocosm	Distance (cm)	Mean TPAH (µg/g)	SD	Variance
Untreated	5	0.640	0.000	0.000
Untreated	20	0.640	0.000	0.000
Untreated	30	0.640	0.000	0.000
New	5	0.840	0.010	0.000
New	20	0.887	0.427	0.183
New	30	0.747	0.185	0.034
Weathered	5	0.640	0.000	0.000
Weathered	20	0.640	0.000	0.000
Weathered	30	0.640	0.000	0.000

creosote, these were presumed to be unassociated with the weathered ties.

Ballast

At 15 months, PAH were detected only in the ballast of the new tie mesocosm. The suite of PAH dominated by fluoranthene, phenanthrene, and pyrene was characteristic of creosote. Much higher levels of PAH were anticipated due to summer heating of the ties. However, the increases observed in the summer of 1998 were not repeated in 1999, and it appears that the initial loss from newly treated ties was associated only with their first exposure to hot summer temperatures. It is possible that the volatile, lighter weight compounds were lost in the first year and that the residual creosote remaining in the ties was not as susceptible to migration associated with high ambient air temperatures. The results for ballast are summarized in Table 15. Differences as a function of treatment and/or distance were not statistically significant at $\alpha = 0.05$ (ANOVA, $F = 1.22$, $p = 0.34$).

Wetland Sediments

The results of these analyses are provided in Table 16. Polycyclic aromatic hydrocarbons were not observed above detection limits in sediments from the untreated tie mesocosm. A single sample at the 75-cm station in the weathered tie mesocosm contained a TPAH of 4.87 µg/g. The PAH spectrum was not dominated by fluoranthene or phenanthrene but instead contained 13 compounds, all at low levels.

This sample might be associated with aged creosote-derived PAH or with another source. A single sample in the new tie mesocosm contained 9.83 µg TPAH/g with a suite of PAH characteristic of creosote. This is the first sediment sample

Table 16—Concentrations of PAH observed in mesocosm wetland sediments at distances of 0, 25, 50, and 75 cm from new and weathered creosote-treated ties and from untreated ties 12 months following placement of the ties

Mesocosm	Distance (cm)	Mean TPAH (µg/g)	SD	95% confidence
Untreated	0	2.277	1.215	1.476
Untreated	25	1.499	0.114	0.013
Untreated	50	1.813	0.562	0.316
Untreated	75	1.328	0.080	0.006
New	0	1.045	0.049	0.002
New	25	1.168	0.122	0.015
New	50	1.076	0.073	0.005
New	75	3.945	5.100	6.015
Weathered	0	1.353	0.317	0.101
Weathered	25	1.058	0.067	0.004
Weathered	50	1.040	0.068	0.005
Weathered	75	2.327	2.202	4.849

observed in this study that shows evidence of creosote-derived PAH migrating from the ballast into adjacent wetland sediments.

18-Month PAH Levels

Two samples collected on the final sampling date were excluded from the analysis. One of these was a 75-cm sediment sample collected in the weathered tie mesocosm. The sample contained elevated concentrations of the HMW compounds benzo(a)anthracene (2.7 µg/g), benzo(b)fluoranthene (1.1 µg/g), benzo(k)fluoranthene (1.2 µg/g), benzo(a)pyrene (2.0 µg/g), and chrysene (3.4 µg/g) plus 2.1 µg/g of naphthalene. Fluoranthene (0.41 µg/g) and phenanthrene (0.598 µg/g) were observed at low levels, and the suite of PAH is not characteristic of creosote. The second sample excluded from the analysis was collected in the untreated tie mesocosm. The TPAH in this sample was 36.555 µg TPAH/g, of which 35.6 µg/g was naphthalene. National Environmental Testing confirmed the results. However, it appears likely that this sample was contaminated during handling or analysis. The results for the remaining 101 samples collected at 18 months are presented below.

Ballast

Significant increases in the concentration of PAH in ballast were not observed in any of the mesocosms on the final day of the study. The initial pulse of PAH that apparently migrated from the newly treated ties into the ballast during the summer of 1998 had weathered and/or dispersed from the ballast by the 6-month testing. The observed mean concentrations are summarized in Table 17. The null

Table 17—Concentrations of PAH observed in railway right-of-way ballast at distances of 5, 20, and 30 cm from new and weathered creosote-treated railway ties and untreated ties 18 months following tie placement. Each value is the mean of three replicates. The detection limit was used as a minimum value for each compound

Mesocosm	Distance (cm)	Mean TPAH (µg/g)	SD	Variance
Untreated	5	0.304	0.000	0.000
Untreated	20	0.305	0.002	0.000
Untreated	30	0.305	0.001	0.000
New	5	0.595	0.139	0.019
New	20	0.638	0.516	0.266
New	30	0.937	0.693	0.481
Weathered	5	0.303	0.000	0.000
Weathered	20	0.303	0.000	0.000
Weathered	30	0.303	0.000	0.000

Table 18—Concentrations of PAH observed in mesocosm wetland sediments at distances of 0, 25, 50, and 75 cm from new and weathered creosote-treated ties and from untreated ties 18 months following placement of the ties

Mesocosm	Distance (cm)	Mean TPAH (µg/g)	SD	95% confidence
Untreated	0	1.060	0.397	0.158
Untreated	50	1.589	1.317	1.735
Untreated	75	1.191	0.662	0.439
New	0	1.357	0.436	0.190
New	50	1.306	0.753	0.557
New	75	0.747	0.286	0.052
Weathered	0	3.437	2.528	6.388
Weathered	50	1.959	1.147	1.317
Weathered	75	1.708	0.312	0.138

hypothesis that all of the means (as a function of distance and treatment) were equal was not rejected at $\alpha = 0.05$ (ANOVA, $F = 1.85$, $p = 0.13$).

Wetland Sediments

Sediment concentrations of PAH are summarized in Table 18. A single high sample (6.26 µg TPAH/g) was observed in one of three replicates collected at the 0.0-cm station in the weathered tie mesocosm. Benzo(a)anthracene (0.99 µg/g), benzo(b)fluoranthene (0.500 µg/g), benzo(k)fluoranthene (0.650 µg/g), benzo(a)pyrene (0.930 µg/g), and chrysene (1.300 µg/g) dominated the suite of PAH. In this sample, fluoranthene was not detected and

Table 19—Concentrations of PAH observed in core samples in mesocosm limestone ballast immediately adjacent to treated and untreated ties. These samples were collected 18 months following placement of the ties

Mesocosm	Depth (cm)	Mean TPAH (µg/g)	SD	95% confidence
Newly treated	0	0.311	0.000	0.000
Newly treated	10	0.430	0.000	0.000
Newly treated	20	0.448	0.000	0.000
Newly treated	30	0.308	0.000	0.000
Newly treated	40	0.745	0.000	0.000
Newly treated	50	0.681	0.000	0.000
Newly treated	60	0.802	0.000	0.000
Newly treated	70	0.626	0.000	0.000
Newly treated	80	0.585	0.000	0.000
Untreated	0	0.452	0.210	0.044
Untreated	10	0.432	0.182	0.033
Untreated	20	0.478	0.238	0.057
Untreated	30	0.670	0.000	0.000
Untreated	40	0.778	0.165	0.027
Untreated	50	1.223	0.000	0.000
Untreated	60	1.291	0.000	0.000
Untreated	70	0.656	0.000	0.000
Untreated	80	0.679	0.000	0.000
Weathered	0	0.724	0.533	0.284
Weathered	10	0.605	0.427	0.182
Weathered	20	0.654	0.495	0.245
Weathered	30	0.969	0.941	0.885
Weathered	40	0.490	0.264	0.070
Weathered	50	0.812	0.000	0.000
Weathered	60	0.617	0.000	0.000
Weathered	70	0.500	0.000	0.000

phenanthrene was detected at a low level (0.410 µg/g), which was not characteristic of creosote. However, the sample was included in the analysis because phenanthrene was detected. The null hypothesis that these means were all equal was not rejected at $\alpha = 0.05$ (ANOVA, $F = 1.41$, $p = 0.26$).

Distribution of TPAH as Function of Depth in Ballast and Sediments at End of Study

Core samples were collected at 10-cm-depth increments from the surface to the plastic mesocosm liner on the last day of this study. The results are summarized in Table 19 and Figure 12 for ballast and in Table 20 and Figure 13 for

Table 20—Concentrations of PAH observed in core samples in mesocosm sediments immediately adjacent to ballast carrying the newly treated ties. These samples were collected 18 months following placement of the ties

Mesocosm	Depth (cm)	Mean TPAH (µg/g)	SD	95% confidence
Newly treated	0	1.207	0.039	0.001
Newly treated	10	1.640	1.338	1.790
Newly treated	20	0.720	0.000	0.000
Newly treated	30	0.614	0.202	0.041
Newly treated	40	0.642	0.296	0.088
Newly treated	50	0.650	0.000	0.000
Newly treated	60	0.482	0.000	0.000

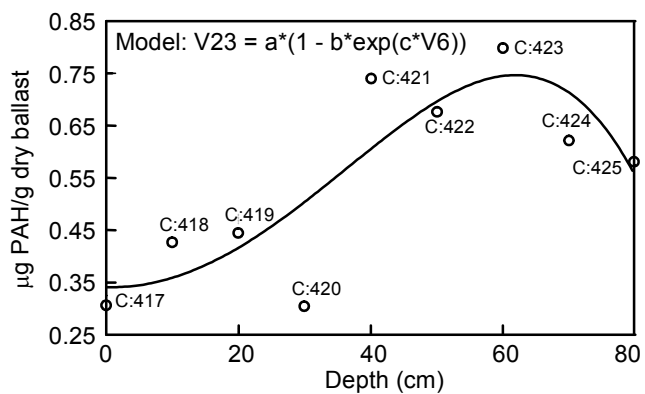

Figure 12—Distribution of the sum of observed concentrations of PAH after 18 months in railway ballast under newly treated crossties.

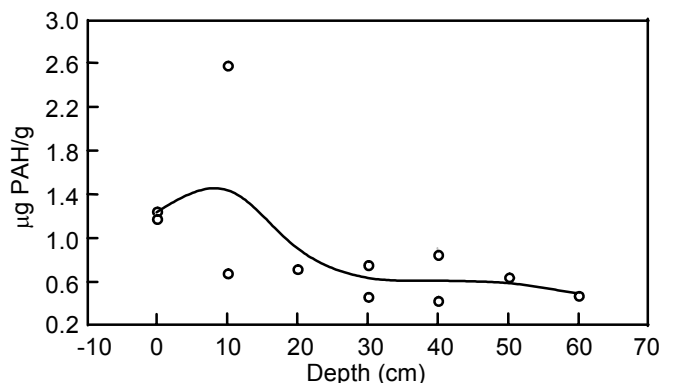

Figure 13—Distribution of the sum of observed concentrations of PAH after 18 months in wetland sediments adjacent to the ballast carrying newly treated crossties.

sediments. A broad spectrum of PAH compounds was observed at very low levels in most samples. Linear and nonlinear regression analysis gave significant coefficients for the constant term and the independent variable depth in ballast. The nonlinear result given in Figure 12 explained more of the variation ($R^2 = 0.55$) than did the linear regression ($R^2 = 0.40$). However, the residuals were not normally distributed in either regression. The results are presented without further transformation because regression analysis is fairly robust with respect to departures from normality and because the observed PAH concentrations are at, or below, baseline PAH levels observed in the Des Plaines River wetland and are of no biological consequence. Having said that, it appears that either small amounts of PAH migrated downward in the ballast during the 18 months of the study or that rates of PAH degradation are higher on the surface, which is exposed to more sunlight. Also, the highest TPAH concentrations in ballast were found in the untreated tie mesocosm at depths of 50 and 60 cm.

In contrast, as seen in Table 20 and Figure 13, little, if any, PAH migrated from the new tie ballast into adjacent sediments and the coefficient describing TPAH as a function of sediment depth was not significantly different from zero. The PAH that did migrate into the sediments at the toe of the ballast appear to be bound in the top 10 cm, and there is little evidence of vertical migration downward into this high organic carbon matrix. Mean sediment values at all depths below 10 cm are somewhat lower but close to baseline sediment TPAH concentrations found in the Des Plaines River wetland.

Hydrologic Profile and Storm and Groundwater PAH Concentrations

Rainfall recorded at the National Oceanic and Atmospheric Association (NOAA) Romeoville, Illinois, station located approximately 0.8 km from the mesocosm site is summarized in Figure 14 for the period of this study. A total of 2.6 m of precipitation fell during this study. Heaviest precipitation occurred in January 1999 when 75.1 cm of rain and snow were recorded. Temperatures were near or below freezing, and the creosote would have been in a solidified almost glass-like state that is insoluble and immobile. Other than the late winter of 1998–1999, precipitation was relatively evenly spread out over the year. The area experienced frequent storm events throughout the summer, and surface water was generally present following these events. Stormwater contamination was most likely after rain showers on warm summer days when the creosote was more mobile.

The water tank supplying the subsurface irrigation system was installed on June 1 and 2, 1998. Water was added to the new and weathered tie mesocosms using this system on June 4, 1998, and again on August 18, 1998. Wetland soils in the mesocosms remained saturated throughout the study period and the subsurface irrigation system functioned as designed.

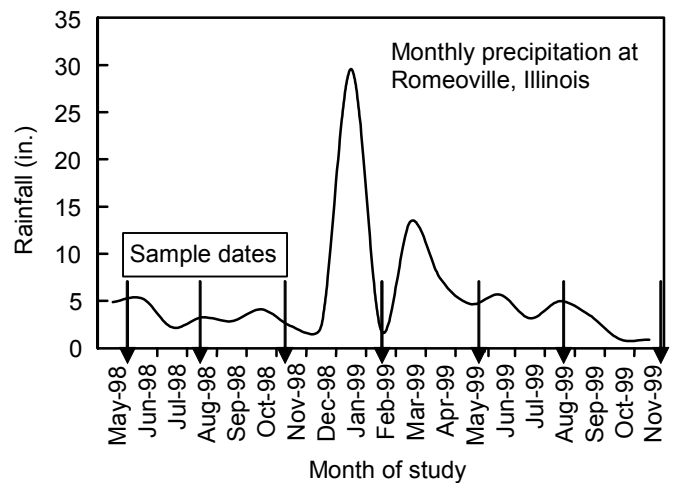

Figure 14—Rainfall reported at the Romeoville, Illinois, NOAA station located ~0.8 km from the mesocosm study site. The smooth line is a fourth order polynomial fit to the data (1 in. = 25.4 mm).

The untreated tie mesocosm was frequently observed to have standing water. Excess surface water was pumped out of the untreated tie mesocosm on July 10 and 11, 1998. No pumping was required in either the new or weathered tie mesocosms.

Significant quantities (enough to sample) of water were not observed in the groundwater monitoring ports, even when the wetlands were inundated. It appears that Des Plaines River wetland soils are so finely textured that water did not percolate downward into the groundwater sumps. Rainwater remained perched on top of the wetland, and water added at the floor of the mesocosm, simulating water flowing in the fractured limestone under the Des Plaines wetland, may have flowed to the surface between the impermeable barrier and the wetland soils. The wetland soils were saturated during the entire study.

Surface water was collected from the mesocosms at about 10 days and 2, 3, 12, 15, and 18 months after tie placement. Polycyclic aromatic hydrocarbons were not detected in any of these 16 samples at the analytical detection limits on any date except the final sample when nanogram per liter quantities of five PAH were detected in all three mesocosms. The results for 18 months are presented in Table 21, which also includes the results of a biological assessment using the methodology of Swartz and others (1995). Swartz and others (1995) recommended a TU benchmark of 0.186 for the protection of biological resources. All of the reported values for mesocosm stormwater were less than this value. This assessment is considered conservative because both particulate and dissolved PAH were measured in this mesocosm study. However, the analysis assumed that all of the reported PAH were in the dissolved phase.

Table 21—Dissolved and particulate PAH observed in mesocosm stormwater at 18 months after tie installation^a

Compound	Un-treated ties (mg/L)	New ties (mg/L)	Weath-ered ties (mg/L)
Acenaphthene	ND	ND	ND
Acenaphthylene	ND	ND	ND
Anthracene	ND	ND	ND
Benzo(a)anthracene	0.00016	0.00019	ND
Benzo(b)fluoranthene	ND	ND	ND
Benzo(k)fluoranthene	ND	ND	ND
Benzo(a)pyrene	ND	ND	ND
Benzo(ghi)perylene	ND	ND	ND
Chrysene	ND	ND	ND
Dibenzo(a,h)anthracene	ND	ND	ND
Fluoranthene	ND	ND	0.0013
Fluorene	ND	ND	ND
Ideno(1,2,3-cd)pyrene	ND	ND	ND
Naphthalene	ND	ND	ND
Phenanthrene	ND	0.00066	0.00058
Pyrene	ND	ND	0.00082
Swartz and others (1995) TPAH toxic units	0.059	0.075	0.104
Swartz and others (1995) benchmark	0.186	0.186	0.186

^aND, no data.

The lack of observable PAH in water adjacent to the simulated railway right-of-way in this mesocosm study was expected. Colwell and Seesman (1976), Wade and others (1987, 1988), and Goyette and Brooks (1999) have all observed very low (biologically inconsequential) levels of PAH in the water column adjacent to creosote-treated wood projects, even when surface sheens were present and high concentrations of PAH were observed in sediments. Bestari and others (1998a) examined water column concentrations of PAH migrating from creosote-treated piling immersed in microcosms (12,000-L tanks). They concluded that “The rapid loss of creosote from water in conjunction with the slow rate of leaching from the pilings suggests that risks associated with the use of creosote-impregnated pilings in aquatic environments may be minimal.” This accumulated evidence fully supports the conclusion of Brooks (1997a) that water column concentrations of PAH associated with creosote-treated wood are simply not of biological significance. It is the accumulation of PAH in sediments that must be managed.

This mesocosm study may provide a mechanism for the study of water movement through hydric soils in the Des Plaines River area. Based on observations to date, it appears that water does not move vertically in these soils. Hypothetically, groundwater is moving primarily through the fractured limestone, which is capped by the hydric wetland soils.

Discussion

The mesocosms were constructed without significant PAH contamination. In other words, this study started with a relatively clean PAH slate. Polycyclic aromatic hydrocarbons, in a profile characteristic of creosote, were observed in ballast immediately adjacent to the newly treated ties within 10 days. A single sample of ballast from the untreated tie mesocosm also contained significantly elevated levels of PAH at about 3 months. Since there were no known sources of PAH in the untreated tie mesocosm, this suggested that care must be taken in evaluating PAH data to not give too much weight to single samples that are different from trends or other replicates.

Data Quality Assurance

Goyette and Brooks (1999) documented changes in the distribution of the proportions of individual PAH compounds during the treatment of wood with creosote and in the weathering of creosote following its loss from treated wood structures in marine environments. These results demonstrated a dramatic shift in PAH composition from one rich in LMW compounds in raw creosote oil to one rich in intermediate-weight compounds in treated wood (particularly phenanthrene, anthracene, fluoranthene, and pyrene). Initially, the distribution of PAH in sediments associated with losses from creosote-treated wood was similar to that found in the wood. However, physicochemical and biological degradative processes appeared to preferentially degrade the remaining LMW compounds during the first 6 months to 1 year leaving a higher proportion of the intermediate and HMW compounds in aged deposits. The result was that new deposits of PAH associated with creosote-treated wood were dominated by intermediate-weight compounds and historic (>1- to 3-year-old) deposits, while still dominated by phenanthrene and fluoranthene, contained increasing proportions of the HMW compounds (four through seven ring structures). This information is useful because PAH are ubiquitous with many natural and anthropogenic sources. In studies such as these, it is informative to be able to distinguish between historic deposits of PAH from unknown sources and newly lost PAH associated with creosote-treated wood. In this study, five of the 450 PAH analyses (1.1%) were excluded from the database because the observed distribution of individual compounds was not characteristic of the suite of PAH compounds observed in association with creosote-treated wood products. One sediment sample in the untreated tie mesocosm contained 35 µg naphthalene/g dry

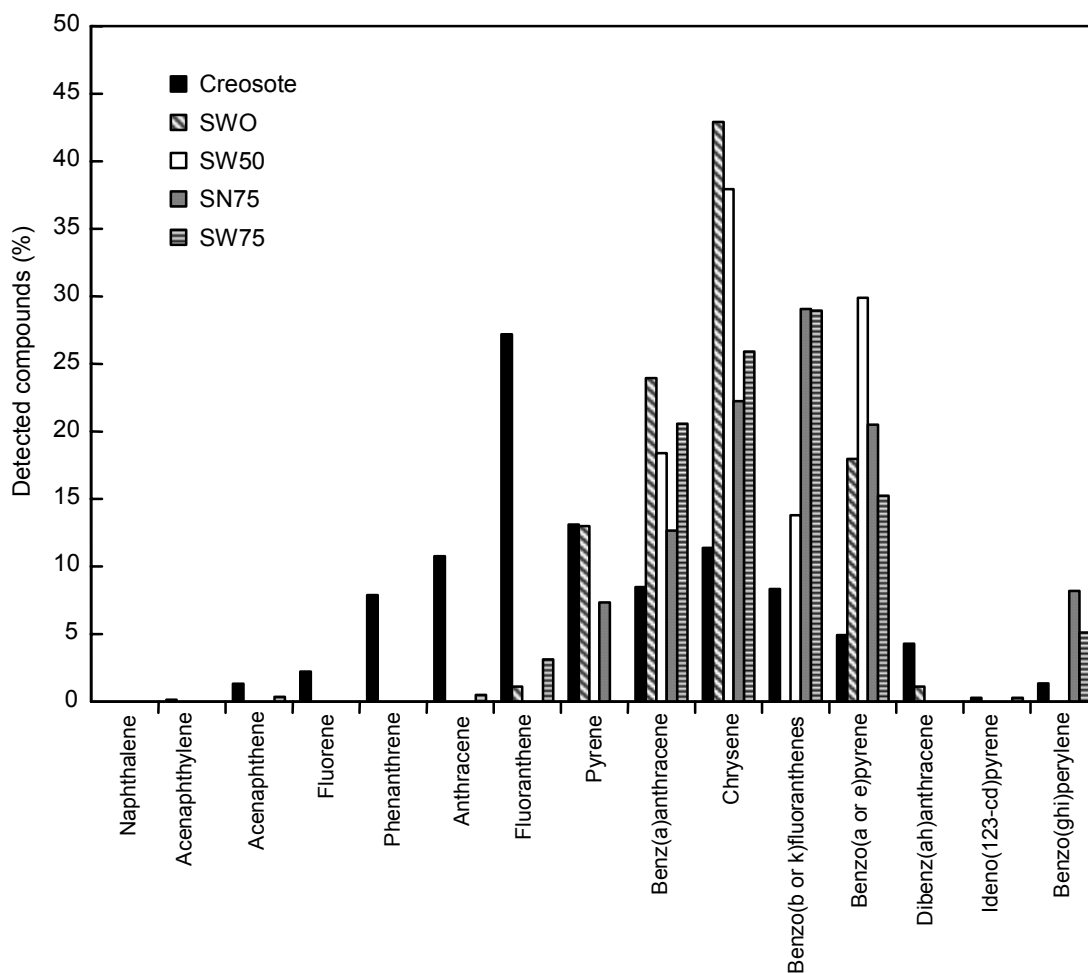

Figure 15—Comparison of 44-month-old creosote-derived mixtures of PAH in sediments with the PAH spectrum observed in samples excluded from the mesocosm study database.

sediment with no other PAH observed. This sample was probably contaminated during collection or analysis. The spectra of PAH compounds observed in the other four excluded samples is compared with the suite of PAH observed in several-year-old creosote deposits in Figure 15. Three of the remaining four samples were collected in the weathered tie mesocosm, and one sample was collected in the new tie mesocosm. Dominant compounds in creosote, including phenanthrene, anthracene, and fluoranthene were either absent or detected at low levels in these samples. The spectrum of PAH in the excluded samples was dominated by benz(a)anthracene, chrysene, benzo(b or k)fluoranthene, benzo(a or e)pyrene, and/or benzo(ghi)perylene. As noted in the Appendix, this spectrum is more likely to be associated with crankcase oil or with very old (>5 to 10 years) creosote-derived PAH. They are not associated with 1- to 3-year-old creosote deposits. The remainder of this analysis excludes these five samples.

PAH in Ballast

Polycyclic aromatic hydrocarbons appeared to migrate from the new creosote-treated ties into adjacent ballast during the first summer following placement. The maximum concentration in ballast reached $\approx 1,000 \mu\text{g TPAH/g}$ dry ballast within 5 cm of the tie face by 3 months. Concentrations declined with distance but remained high at 20 cm. The initially high ballast PAH concentrations declined significantly during the remainder of the study. A second pulse of PAH was not observed during the second summer of this study and significant PAH loss from the ties appeared restricted to the first period of high temperatures. Creosote-treated wood is black and is expected to absorb a broad spectrum of solar radiation. Temperatures high enough to volatilize the LMW compounds could be achieved during hot summer weather.

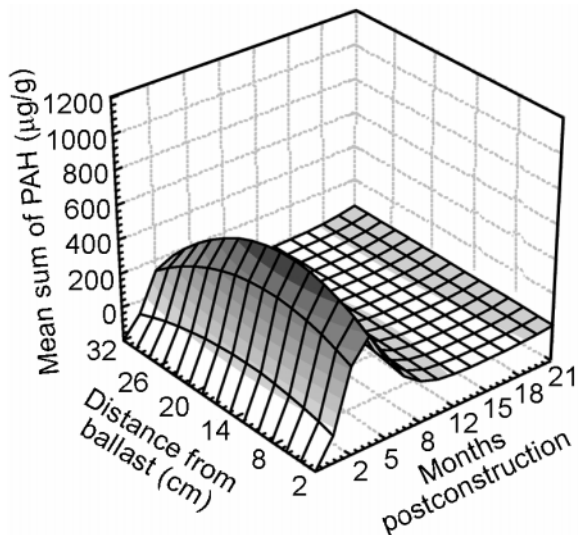

Figure 16—Spatial and temporal trends in the concentration of PAH observed in ballast adjacent to newly treated railway ties during the first 18 months following construction. Analysis of 16 PAH was accomplished in broken limestone ballast at distances of 5, 20, and 30 cm from the face of the ties.

This may explain the elevated ballast concentrations observed in August of the first year of the study (3 months). Polycyclic aromatic hydrocarbons migrating into the crushed limestone ballast would most likely evaporate and be chemically and photochemically degraded in the dry, porous ballast environment. Little microbial degradation was expected in ballast. As discussed in a previous section of this report, it is also possible that a small portion of the creosote-derived PAH moved vertically downward in the ballast and/or was washed out of ballast into the surrounding wetland. Figure 16 is a three-dimensional contour plot constructed using a distance-weighted least squares algorithm. It describes the spatial and temporal distribution of PAH in limestone ballast supporting newly treated railway ties during the 18 months of this study.

Other than one sample, significantly elevated concentrations of PAH were not observed in the untreated tie mesocosm. As shown in Figure 16, a small pulse of PAH was also observed in ballast immediately adjacent to the weathered ties during the first summer. However, the PAH concentrations were low with a maximum observed mean concentration of $1.489 \pm 2.918 \mu\text{g TPAH/g ballast}$. Figure 17 is a three-dimensional contour plot describing ballast concentrations of TPAH as a function of time and distance from the faces of weathered ties in this study.

PAH in Wetland Sediments

Concentrations of TPAH varied with time and distance in all three mesocosms. The TPAH values used in this analysis assume that undetected compounds were present at the

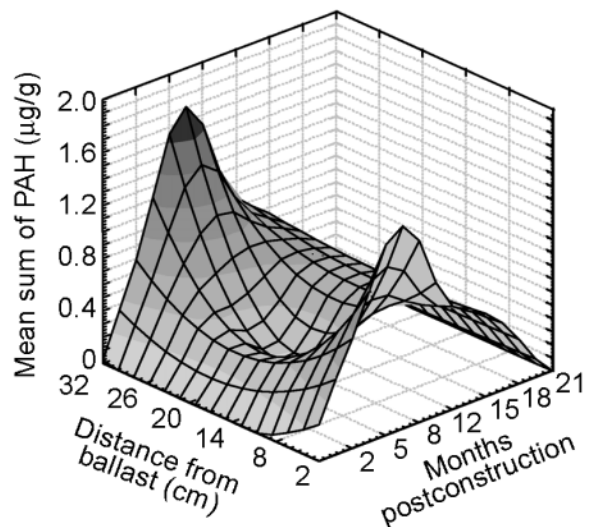

Figure 17—Spatial and temporal trends in the concentration of PAH observed in ballast adjacent to old, weathered railway ties during the 18 months following construction. Analysis of 16 PAH was accomplished in broken limestone ballast at distances of 5, 20, and 30 cm from the face of the ties.

detection limit. That assumption is probably overly conservative and will be discussed in a subsequent section of this report. The spatial and temporal profiles associated with PAH in wetland sediments are described in Figure 18 for the untreated, weathered, and newly treated tie mesocosms. In general, the concentration of PAH increased during the summer of the second year of the study. Wetland sediment concentrations then declined in the new tie and untreated tie mesocosms but remained slightly elevated at the zero meter ($1.708 \pm 0.421 \mu\text{g TPAH/g}$) and 0.75 meter ($3.435 \pm 2.860 \mu\text{g TPAH/g}$) stations. Values are mean \pm 95% confidence intervals.

The highest sediment concentration ($3.945 \mu\text{g TPAH/g}$) was observed in the newly treated tie mesocosm after 15 months at the furthest station from the ballast (75 cm). The variance to mean ratio for these three samples was 1.46, suggesting a slightly more patchy distribution than would be expected from a randomly distributed variable. At 18 months, sediment concentrations had declined to between 0.209 and $1.357 \mu\text{g TPAH/g dry sediment}$. The 18-month sediment concentrations observed in the new tie mesocosm were less than those observed in the untreated tie mesocosm (0.486 to 1.541). However, the lower value was not significant at $\alpha = 0.05$.

Goyette and Brooks (1999) presented evidence suggesting that the creosote remains in a particulate form in sediments and that these particles gradually work their way deeper into sediments or that they adhere to inorganic and organic surfaces such as cobbles and gravel. Brooks (unpublished data) has observed that microspheres or particles of creosote oil

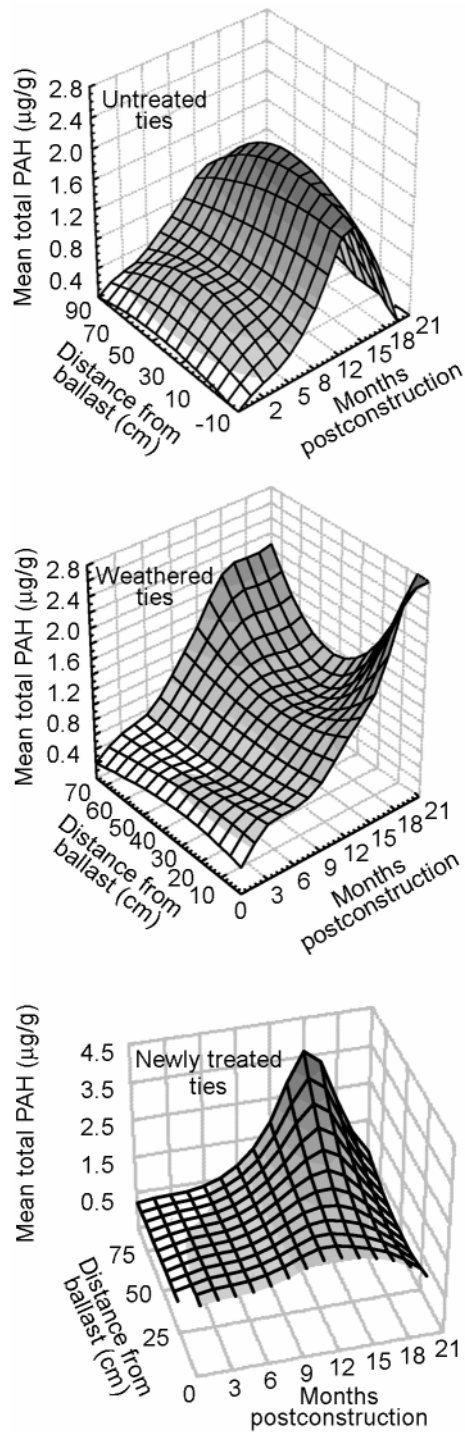

Figure 18—Spatial and temporal distribution of the TPAH observed in sediments from the untreated tie, weathered tie, and newly treated tie mesocosms.

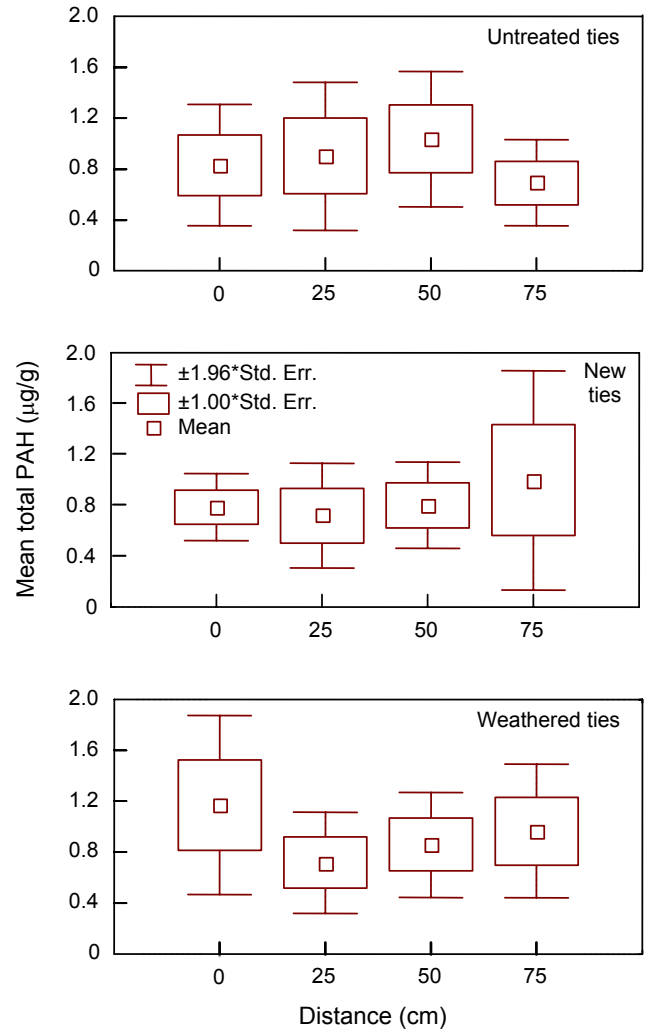

Figure 19—Box and whisker plots describing the nonsignificant differences in mean TPAH concentrations in sediments as a function of distance from railway tie faces and tie treatment.

remain intact in ground oyster shell and/or white sand for up to 2 years. The patchy distribution of PAH observed in this study (variance to mean ratios much >1) is consistent with observations in Sooke Basin and supports the particulate transport hypothesis for creosote-derived PAH.

Observed differences in mean TPAH values were not significantly different as a function of the sample's distance from the face of the tie (ANOVA, $F = 0.33$, $p = 0.96$). These relationships are described in Figure 19. Mean TPAH values were also not significantly different between treatments (ANOVA, $F = 0.76$, $p = 0.72$). However, these differences were significantly different as a function of day (ANOVA, $F = 12.46$, $p = 0.000$). These differences are described in Figure 20 using box and whisker plots for each treatment as a function of time. This suggests that seasonal changes in

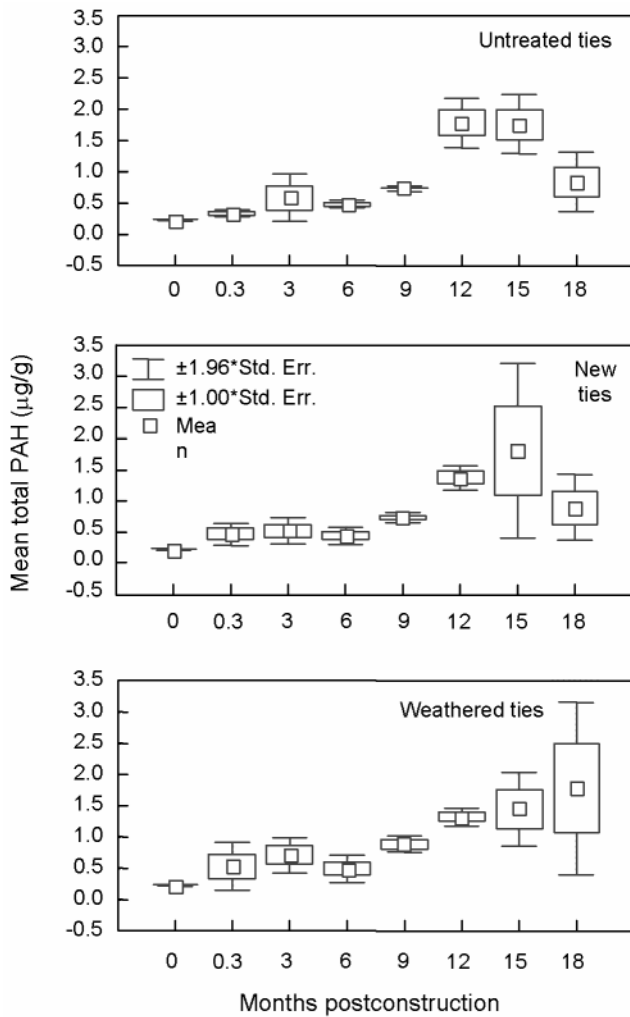

Figure 20—Box and whisker plots describing significant (ANOVA, $P = 0.000$) differences in mean TPAH concentrations in sediments as a function of time following placement of untreated oak ties and newly treated or weathered creosote-treated oak ties.

wetland sediment concentrations of PAH were not associated with the presence of the ties but rather with atmospheric deposition, which would affect all mesocosm treatments and all distances equally, as was observed.

The preceding summary was based on the conservative assumption that undetected PAH compounds were present at the analytical detection limit. Figure 21 shows the relationship between the reported TPAH concentrations and only the detected PAH. The apparent seasonal trend in observed differences may be associated with the proportion of solids in the samples, which changes with water content and therefore with season. This analytical phenomenon was not investigated as part of the study. Each value is the mean for all treatments and distances on a particular day. This is considered a valid grouping because significant differences were not observed as a function of either of these variables.

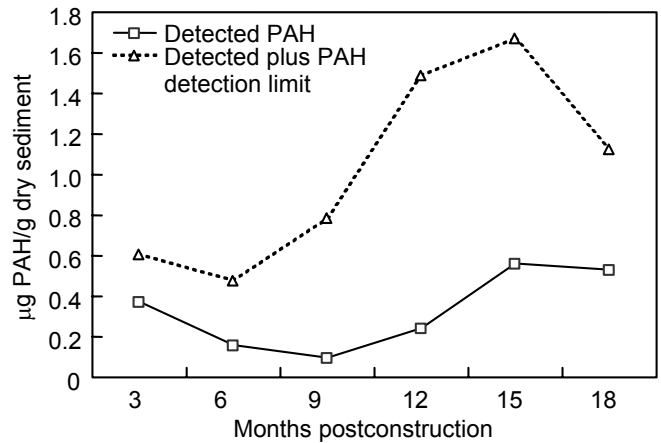

Figure 21—Relationship between sum of the detected PAH and the detected PAH plus the analytical detection limit for each compound. Each value is the mean for all treatments and distances on a particular day in the study.

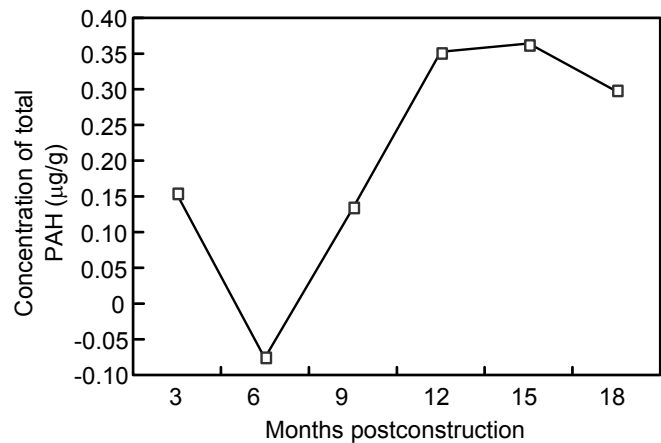

Figure 22—Differences in detected PAH between mesocosms containing creosote-treated railway ties and a mesocosm containing identical untreated oak ties.

These results strongly suggest that seasonally varying atmospheric PAH deposition is a major source of the observed low levels of PAH. The question of whether or not the creosote-treated railway ties contribute PAH to adjacent wetlands remains. This question is explored in Figure 22 which summarizes the mean concentrations of the sum of PAH observed in the weathered and new tie mesocosms less the mean observed in the untreated tie mesocosm. This summary suggests that the concentrations of PAH in treated tie mesocosm sediments were not elevated above that observed in the untreated tie mesocosm during the first 9 months of the study. However, it also appears that during the last three sample periods, the concentrations of detected PAH were elevated by $\approx 0.35 \mu\text{g PAH/g}$ dry sediment in the mesocosms containing creosote-treated ties compared with the untreated mesocosm. The significance of these increases

was investigated using a new variable equal to the detected PAH in creosote-treated wood mesocosm samples less the mean detected PAH concentration observed in sediment samples collected from the untreated mesocosm on the same day. This variable was subjected to ANOVA using a nested design with treatment, day, and distance as dependent variables. Increases in detected PAH observed in the weathered and new tie mesocosms were not significantly different as a function of treatment ($p = 0.47$), day ($p = 0.10$), or distance ($p = 0.86$). Increases in the TPAH would have been significant for day at $\alpha = 0.10$.

Summary

The results from this study suggest the following:

- An initial pulse of PAH was observed moving from the treated railway ties into their supporting ballast during the summer of the first year following construction. More PAH migrated from the newly treated ties into ballast than from the weathered ties during this first summer.
- Creosote oil, containing PAH, is heated during the summer. Creosote-treated wood surface temperatures were not measured. However, the black surface of the railway ties probably attracts sunlight, and high temperatures are quite possible.
- At sufficiently high temperatures, the expansion of the wood forces creosote oil to the surface where it coalesces to form droplets that may run down the face of the treated wood into ballast. Alternately, these droplets may form blisters that pop, projecting minute particles of creosote an unknown distance (probably within 30 cm).
- Polycyclic aromatic hydrocarbons, particularly the intermediate and HMW compounds are hydrophobic with solubilities ranging from 0.07 mg/L for anthracene to 0.00026 mg/L for benzo(g,h,i)perylene. They adhere to most dry surfaces (like ballast rocks) and are immobilized.
- Railway ballast contains little organic material, and it is unlikely that bacterial communities capable of metabolizing PAH would thrive in this environment. However, PAH are degraded by photo- and chemical oxidation (weathering), and these processes probably represent the primary degradative pathways for creosote-derived PAH in railway ballast.
- The sampling schedule was changed in an effort to determine if similar PAH losses would occur during the second summer of the study. No significant loss from ties in either mesocosm was observed during the second summer.
- A small portion of these PAH appear to have moved vertically down into the ballast to a depth of approximately 60 cm. The observed TPAH concentrations, including the value of the detection limit for undetected compounds was less than 0.85 μg TPAH/g dry ballast at any depth.

- It appears that atmospheric deposition of PAH contributes much of the observed baseline to Des Plaines River wetland sediments.
- Small amounts of PAH may have migrated from the ballast into adjacent wetlands during the second summer of this study. The PAH spectrum in these samples and a comparison of PAH concentrations in the untreated mesocosm with the creosote treatments suggests that these increases ($\sim 0.3 \mu\text{g/g}$) were real. However, the observed increases were not statistically significant as a function of distance, treatment, or day of the study.
- PAH were detected in 1 of 16 water samples. Those samples were collected on the final day of the study. Benzo(a)anthracene was observed in the untreated and new tie mesocosms. Phenanthrene was detected in the new tie mesocosm, and fluoranthene, phenanthrene, and pyrene were detected in stormwater from the weathered tie mesocosm. The PAH concentrations were all very low, and an assessment using the sum of TU described by Swartz and others (1995) indicated that none of the samples approached the benchmark recommended by those authors for the protection of aquatic life.

These results suggest that it is reasonable to expect a detectable migration of creosote-derived PAH from newly treated railway ties into supporting ballast during their first exposure to hot summer weather. The PAH rapidly disappeared from the ballast during the fall and winter following this initial loss. The statistically insignificant vertical and horizontal migration of these PAH suggests that they either evaporated or where chemically and/or photochemically degraded.

Biological Assessment

Much of the preceding discussion focused on the migration of PAH from creosote-treated railway ties into supporting ballast and from the ballast into the adjacent wetland environment. Regardless of the source of PAH, it is the cumulative effect of all observed PAH that contribute to potential stress and at low concentrations to chronic toxicity. The following assessment will assume that individual PAH compounds were present at the analytical detection limit when they were not detected. This is a very conservative assessment, which probably overestimates the potential for adverse effects.

As previously discussed, PAH were only observed in stormwater on the final day of sampling. These compounds were observed in all three mesocosms on that day at levels below the sum of TU threshold defined by Swartz and others (1995). Biological stress, including that associated with photo enhanced PAH toxicity, cannot reasonably be predicted at the observed concentrations. Brooks (1997a) has argued that dissolved concentrations of PAH found in association with creosote-treated wood are not expected to create

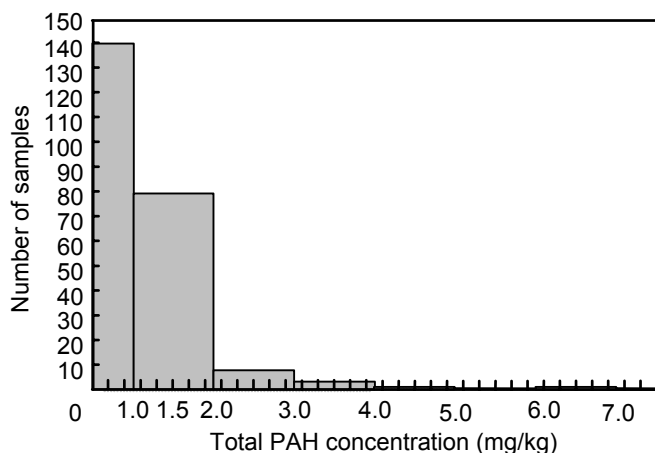

Figure 23—Number of mesocosm sediment samples as a function of the observed TPAH in the sample.

environmental stress. It is sedimented PAH that must be managed to ensure the integrity of plants and animals living in the vicinity of treated wood. Swartz (1999) was chosen as a conservative benchmark for use in evaluating the biological response to sedimented PAH in this study.

Polycyclic aromatic hydrocarbons are hydrophobic and bind with organic molecules in aquatic environments. This reduces their bioavailability and potential toxicity. In recognition of this, most organic contaminant benchmarks are based on the concentration of the contaminant expressed in micrograms of contaminant per gram of organic carbon. Des Plaines River wetland sediments used in this study were analyzed for TOC and/or TVS at the beginning and end of the study. A mean TOC value of 11.91% was determined.

Figure 23 is a histogram describing the number of sediment samples as a function of observed TPAH in the sample (including the detection limit for undetected compounds). Of the 234 samples, 140 contained PAH concentrations <1.0 µg TPAH/g. Concentrations in an additional 80 samples were between 1.0 and 2.0 µg TPAH/g. Only 2 of the 234 sediment samples exceeded 3.93 µg TPAH/g, the toxicity threshold for TPAH given by Swartz (1999) in 1% TOC sediments. None of the samples exceeded the Swartz (1999) benchmark for TPAH in 11.9% TOC sediments. The two samples higher than 3.93 µg TPAH/g were chosen for an evaluation of individual compounds because one was from the weathered tie mesocosm (6.26 µg TPAH/g) and the other from the newly treated tie mesocosm (9.83 µg TPAH/g). The results of computing the sum of TU at the mean sediment TOC are presented in Table 22. Three benchmarks were presented for each compound in constructing Table 23. However, in this case, the PAH levels are so low that the observed TU calculations will be compared only with the toxic threshold benchmark. Recall that this is the value below which no adverse biological affects should be

anticipated in any species. The LC₅₀ value represented the concentration above which significant adverse affects should always be anticipated, and the mean of these two values was suggested as representative of the concentration above which adverse affects were likely to be observed in sensitive species. In sediments containing 11.9% TOC, the TPAH mixture LC₅₀ is 251.8 µg TPAH/g dry sediment and the mean value is 149.3 µg TPAH/g. The sediment PAH concentrations observed in this study were between one and two orders of magnitude lower than these levels. Tables 22 and 24 compare the observed sediment concentrations of PAH in the highest weathered tie and newly treated tie mesocosms with their respective toxicity thresholds.

None of the PAH compounds exceeded their toxic threshold, nor did any of the classes of mixtures. No toxicity could be expected in association with either of these two highest samples, and therefore, no toxicity can reasonably be expected with the several hundred samples in which the TPAH compounds were in the range of 1 to 2 µg TPAH/g dry sediment. Aside from the lack of evidence of toxicity, there are several interesting points in Tables 22 and 24.

- Consistent with the Sooke Basin study (Goyette and Brooks 1999), phenanthrene was the most problematic compound associated with the new tie mesocosm. The phenanthrene concentration in the single highest sample collected from the new tie mesocosm represented 0.657 toxicity threshold units.
- Low molecular weight PAH compounds made up 34.7% of the observed PAH in the highest newly treated tie mesocosm sediment sample but only 14.5% of the PAH in the highest sediment sample from the weathered tie mesocosm. This is consistent with the preferential loss of LMW compounds as creosote-treated wood ages.
- Similarly, the LMW compounds resulted in a higher TU value (0.310) than did the HMW compounds (0.166 TU) in the new tie mesocosm sample. In contrast, the LMW compounds were represented by a very low TU value (0.070) in comparison with the HMW compounds (0.122 TU) in the weathered tie mesocosm.

This discussion should not be misunderstood. The preceding analysis focuses on the two sediment samples with the highest PAH concentrations in a dataset consisting of 234 samples, most of which contained less than 2.0 µg TPAH/g dry sediment. The reason for belaboring these two samples is that they show spectra similar to that expected from creosote and to demonstrate the lack of toxicity in even the highest samples. There is no indication in this study that PAH lost from either the newly treated or weathered ties presents any potential stress for dragonflies or any other sensitive species in this wetland.

Table 22—Summary of the TPAH toxicity threshold and the observed concentration of PAH compounds and classes of compounds in the newly treated tie mesocosm sample with the highest concentration of PAH. These sediments contained a mean of 11.9% total organic carbon

PAH compound	TPAH toxicity threshold (µg PAH/g dry sediment)	Observed concentration (µg PAH/g dry sediment)	Toxic units ^a
Naphthalene	1.548	0.062	0.040
Acenaphthylene	0.357	0.062	0.174
Acenaphthene	0.476	0.150	0.315
Fluorene	2.025	0.220	0.109
Phenanthrene	3.454	2.270	0.657
Anthracene	2.501	0.450	0.180
Fluoranthene	8.218	2.220	0.270
Pyrene	10.719	1.400	0.131
Benz(a)anthracene	2.501	0.680	0.272
Chrysene	3.692	0.630	0.171
Benzo(b)fluoranthene	3.930	0.350	0.089
Benzo(k)fluoranthene	3.454	0.340	0.098
Benzo(a)pyrene	3.930	0.430	0.109
Low molecular weight PAH	10.362	3.214	0.310
High molecular weight PAH	36.445	6.050	0.166
Total PAH	46.806	9.264	0.198

^aNumber of toxic units (Swartz 1999) associated with each compound.

Table 23—Summary of freshwater and estuarine benchmarks for PAH^{a, b}

PAH level (µg/g)	Benchmark type	Jurisdiction	Source
Freshwater			
100 (TPAH)	SLCA severe effects level	British Columbia	BCMOELP (1994)
110 (TPAH)	SLCA severe effects level	Ontario	Persaud and others (1992)
13.3 (TPAH)	Recommended threshold concentration	United States	Ingersoll and others (1996)
2.0 (TPAH)	OMOE provincial SQG—lowest effect level	Ontario	Persaud and others (1992)
22.0 (TPAH)	AETA apparent effects threshold	British Columbia	BCMOELP (1994)
4.0 (TPAH)	WEA effects range low	British Columbia	BCMOELP (1994)
2.9 (TPAH–OC)	Threshold effects concentration		Swartz (1999)
18.0 (TPAH–OC)	Median effects concentration		Swartz (1999)
Marine and estuarine			
205 (TPAH)	AET (estuarine)	Mississippi	Lytle and Lytle (1985)
4.0 (TPAH)	Effects range-low	NOAA	Jones and others (1997)
44.8 (TPAH)	Effects range-median	NOAA	Jones and others (1997)
13.3 (LPAH & HPAH)	AET (estuarine and marine)	Washington	WAC 173-204

^aUnited Nations University (2001).

^bTPAH, total PAH; OC, organic carbon; LPAH, low molecular weight PAH; HPAH, high molecular weight PAH; SLCA, screening level concentration approach; OMOE, Ontario Ministry of the Environment; SQG, sediment quality guideline; AET apparent effects threshold; AETA, apparent effects threshold approach; WEA, weight of evidence approach; NOAA, National Oceanic and Atmospheric Association; WAC, Washington Administrative Code.

Table 24—Summary of the TPAH toxicity threshold and the observed concentration of PAH compounds and classes of compounds in the weathered tie mesocosm sample with the highest concentration of PAH. These sediments contained a mean of 11.9% total organic carbon^a

PAH compound	TPAH toxicity threshold ($\mu\text{g PAH/g dry sediment}$)	Observed concentration ($\mu\text{g PAH/g dry sediment}$)	Toxic units ^b
Naphthalene	1.548	0.037	0.024
Acenaphthylene	0.357	0.089	0.249
Acenaphthene	0.476	0.030	0.063
Fluorene	2.025	0.100	0.049
Phenanthrene	3.454	0.410	0.119
Anthracene	2.501	0.059	0.024
Fluoranthene	8.218	0.190	0.023
Pyrene	10.719	0.430	0.040
Benz(a)anthracene	2.501	0.990	0.396
Chrysene	3.692	1.300	0.352
Benzo(b)fluoranthene	3.930	0.500	0.127
Benzo(k)fluoranthene	3.454	0.650	0.188
Benzo(a)pyrene	3.930	0.930	0.237
Low molecular weight PAH	10.362	0.725	0.070
High molecular weight PAH	36.445	4.990	0.137
Total PAH	46.806	5.715 ¹	0.122

^aThe TPAH for these samples given in Tables 23 and 24 is slightly lower than determined in this study because the model of Swartz (1999) considers only 13 PAH compounds and, in this study, 16 PAH compounds were evaluated. This is not considered a significant flaw in the analysis because the PAH not considered by Swartz (1999) were not detected or detected at low levels in these samples.

^bNumber of toxic units (Swartz 1999) associated with each compound.

Conclusions

Brooks (1996) assessed the potential impact of this railway right-of-way on the Hines emerald dragonfly (*Somatochlora hineana*) and concluded that, based on the limited data available at that time, “There was no indication that the past use of creosote ties, or their current replacement (new ties) had compromised the biological integrity of wetland plants or animals (including *Somatochlora hineana*).” The completion of the River South PAH study (Brooks 1997b) and the results from this study have added significantly to the database on biological effects associated with creosote-treated railway ties. The following conclusions are substantiated by the results presented herein:

- The PAH spectrum associated with creosote changes with time. The proportion of HMW compounds increases as the LMW compounds are degraded or evaporate. However, creosote-derived PAH mixtures are dominated by phenanthrene and fluoranthene for at least the first 2 to 3 years following migration from the wood. The PAH spectra provided in this report give insight into discriminating sources of PAH. However, mixtures of PAH derived from creosote and other sources may not be as amenable to simple analysis.
- Creosote-derived PAH probably migrated from newly treated railway crossties into supporting ballast during the summer of the first year. In this study, this pulse was not observed during the second summer. However, other site-specific behavior will depend on the wood species, creosote retention, and solar insolation and ambient air temperatures.
- Creosote oil, containing PAH, is heated during the summer because the black surface of the railway ties absorbs sunlight. However, creosote-treated wood surface temperatures were not measured.
- At sufficiently high temperatures, the expansion of the wood forces creosote oil to the surface where it coalesces to form droplets that may run down the face of the treated wood into ballast. Alternately, these droplets may form blisters that burst, projecting minute particles of creosote an unknown distance (probably up to 30 cm).
- Polycyclic aromatic hydrocarbons, particularly the intermediate and HMW compounds are hydrophobic, with solubilities ranging from 0.07 mg/L for anthracene to 0.00026 mg/L for benzo(ghi)perylene. They adhere to most dry surfaces (like ballast rocks) and are immobilized.

- Railway ballast contains little organic material, and it is unlikely that bacterial communities capable of metabolizing PAH would thrive in this environment. However, PAH are degraded by photo- and chemical oxidation (weathering), and these processes probably represent the primary degradative pathways of creosote-derived PAH in railway ballast.
- A small portion of these PAH appeared to have moved vertically down into the ballast to a depth of approximately 60 cm. The observed TPAH concentrations, including the value of the detection limit for undetected compounds, was less than 0.85 µg TPAH/g dry ballast.
- It appears that atmospheric deposition of PAH contributes much of the observed baseline to the Des Plaines River wetland sediments.
- Small amounts of PAH may have migrated from the ballast into adjacent wetlands during the second summer of this study. The PAH spectrum in these samples and a comparison of PAH concentrations in the untreated mesocosm with the creosote treatments suggests that these increases (~0.3 µg/g) were real. However, the observed increases were not statistically significant as a function of distance, treatment, or day of the study.
- PAH were detected in 1 of 16 water samples. Those samples were collected on the final day of the study. Benzo(a)anthracene was observed in the untreated and new tie mesocosms. Phenanthrene was detected in the new tie mesocosm, and fluoranthene, phenanthrene, and pyrene were detected in stormwater from the weathered tie mesocosm. The PAH concentrations were all very low, and an assessment using the sum of TU described by Swartz and others (1995) indicated that none of the samples approached the benchmark recommended by those authors for the protection of aquatic life.
- The PAH concentrations observed in the highest wetland sediment samples collected in the newly treated tie or weathered tie mesocosms are not predicted to be stressful using the consensus sediment benchmark methodology of Swartz (1999). No adverse biological effects can reasonably be predicted at the observed levels of PAH. This assessment assumed that undetected PAH compounds were present at the analytical detection limit. This makes this assessment, particularly the biological assessment, very conservative because the reported TPAH concentrations probably overestimate those present.

As discussed in the introduction to this study, there are many sources of PAH associated with railway transportation systems. These include diesel exhaust, lubricating oils, cargo (coal and oil), and herbicides. A mesocosm study was designed to minimize these compounding sources of PAH and to focus on those associated with creosote-treated railway ties. These results suggest that seasonally variable

atmospheric deposition of PAH contributes a significant portion of the baseline observed throughout the Des Plaines River wetland. It also appears that on average, the use of creosote-treated railway ties may add an additional 0.3 µg TPAH/g dry sediment within half a meter of the toe of the ballast. Even the two highest observed PAH concentrations did not reach toxic threshold levels in these wetland sediments.

Recommendations

This study suggests that newly treated railway ties pose minimal environmental risk, even in sensitive wetland environments. However, experience from this study suggests the following three management practices to ensure that risks are minimized:

1. Numerous derelict railway crossties were observed after having been discarded alongside this right-of-way in the Des Plaines River wetland. Ties taken out of service should be properly disposed of.
2. The early loss of creosote from treated wood during first exposure to summer heat was observed in this study and has been reported by Brooks (2000) in association with creosote-treated timber bridges. The temporary storage of newly treated railway crossties in sensitive environments while awaiting installation should be avoided. Ties should be stored on the ballast or on railway cars.
3. Railway ties should be produced using management practices that reduce the probability of significant creosote loss from deep checks in the wood or from excess surface deposits. The ties used in this study were randomly selected. They were relatively clean and free from surface creosote deposits.

Literature Cited

- Ames, B.W., McCann, J.; Yanasaki, E.** 1975. Methods for detecting carcinogens and mutagens with the *Salmonella/mammalian-microsome* mutagenicity test. *Mutation Research*. 31: 347–363.
- Ankley, G.T.; Erickson, R.J.; Phipps, G.L. [and others].** 1995. Effects of light intensity on the phototoxicity of fluoranthene to a benthic macroinvertebrate. *Environmental Science and Technology*. 29: 2828–2833.
- AWPA.** 1996. Book of standards. Woodstock, MD: American Wood-Preservers' Association.
- Axelman, J.; Naes, K.; Naf, C.; Broman, D.** 1999. Accumulation of polycyclic aromatic hydrocarbons in semipermeable membrane devices and caged mussels (*Mytilus edulis* L.) in relation to water column phase distribution. *Environmental Toxicology and Chemistry*. 18(11):2454–2461.

- Baekken, T.** 1994. Effects of highway pollutants on a small Norwegian lake. Hamilton, R.S.; Revitt, D.M; Harrison, R.M; Monzon de Caceres, A., eds. Highway-Pollution. 146–147:131–139.
- Basu, D.K.; Saxena, J.; Stoss, F.W. [and others].** 1987. Comparison of drinking water mutagenicity with leaching of polycyclic aromatic hydrocarbons from water distribution pipes. *Chemosphere CMSHAF*. 16(10–12): 2592–2612.
- BCMOELP.** 1994. Approved and working criteria for water quality—1994. Victoria, British Columbia: British Columbia Ministry of Environmental Lands and Parks, Water Quality Branch, Environmental Protection Department. 45 p.
- Bender, M.E.; Roberts, M.H.; deFur, P.O.** 1987. Unavailability of polynuclear aromatic hydrocarbons from coal particles to the Eastern oyster. *Environmental Pollution*. 44(4): 243–260.
- Bestari, K.T.J.; Robinson, R.D.; Solomon, K.R. [and others].** 1998a. Distribution and composition of polycyclic aromatic hydrocarbons within experimental microcosms treated with creosote-impregnated Douglas Fir pilings. *Environmental Toxicology and Chemistry*. 17(12): 2369–2377.
- Bestari, K.T.; Robinson, R.D.; Solomon, K.R. [and others].** 1998b. Distribution and composition of polycyclic aromatic hydrocarbons within experimental microcosms treated with liquid creosote. *Environmental Toxicology and Chemistry*. 17(12): 2359–2368.
- Bogan, B.W.; Lamar, R.T.** 1995. One-electron oxidation in the degradation of creosote polycyclic aromatic hydrocarbons by *Phanerochaete chrysosporium*. *Applied and Environmental Microbiology*. 61(7): 2631–2635.
- Boldrin, B.; Tiehm, A.; Fritasche, C.** 1993. Degradation of phenanthrene, fluorene, fluoranthene and pyrene by a *Mycobacterium* sp. *Applied and Environmental Microbiology*. 59: 1927–1930.
- Borthwick, P.W.; Patrick, J.M.** 1982. Use of aquatic toxicology and quantitative chemistry to estimate environmental deactivation of marine-grade creosote in seawater. *Environmental Toxicology and Chemistry*. 1: 281–288.
- Bouloubassi, I.; Saliot, A.** 1991. Composition and sources of dissolved and particulate PAH in surface waters from the Rhone Delta (NW Mediterranean). *Marine Pollution Bulletin*. 22(12): 588–594.
- Bradley, L.J.N.; Magee, B.H.; Allen, S.L.** 1994. Background levels of polycyclic aromatic hydrocarbons (PAH) and selected metals in New England urban soils. *Journal of Soil Contamination*. 3(4): 349–361.
- Brisou, J.** 1972. Lipids, sterols, terpenes and bacterial biosynthesis of 3, 4-benzopyrene. In: Mallet, L., ed. *Pollution des Mileaux Vitaux par les Hydrocarbures Polybenzeniques du Type Benzo-3, 4-pyrene*: 181–183. (In French).
- Broman, D.; Naf, C.N.; Lundbergh, I.; Zebuhr, Y.** 1990. An in situ study on the distribution, biotransformation and flux of polycyclic aromatic hydrocarbons (PAHs) in an aquatic food chain (Seston–*Mytilus edulis*–*Somateria mollissima*) from the Baltic: an ecotoxicological perspective. *Environmental Toxicology and Chemistry*. 9:429–442.
- Brooks, K.M.** 1996. Risk assessment for Hines emerald dragonfly (*Somatochlora hineana*) associated with the use of creosote treated railway ties. Chicago IL: Commonwealth Edison Company, Environmental Services Department. 22 p. plus appendices.
- Brooks, K.M.** 1997a. Literature review, computer model and assessment of the potential environmental risks associated with creosote treated wood products used in aquatic environments. Vancouver, WA: Western Wood Preservers Institute. 139 p.
- Brooks, K.M.** 1997b. PAH sediment sampling study in River South Parcel—July 17, 1996 to August 26, 1997. Final report. Chicago IL: Commonwealth Edison Company, Environmental Services Department. 22 p. plus appendices.
- Brooks, K.M.** 2000. Assessment of the environmental effects associated with wooden bridges preserved with creosote, pentachlorophenol or chromated-copper-arsenate. Res. Pap. FPL–RP–587. Madison, WI: U.S. Department of Agriculture, Forest Service, Forest Products Laboratory. 100 p.
- Burns, W.A.; Mankiewicz, P.J.; Bence, A.E. [and others].** 1997. A principal-component and least-squares method for allocating polycyclic aromatic hydrocarbons in sediment to multiple sources. *Environmental Toxicology and Chemistry*. 16(6): 1119–1131.
- Caldwell, R.S.; Caldarone, E.M.; Mallon, M.H.** 1977. Effects of a seawater-soluble fraction of Cook Inlet crude oil and its major aromatic components on larval stages of the Dungeness crab, *Cancer magister* Dana. In: Wolfe, D.A., ed. *Fate and effects of petroleum hydrocarbons in marine ecosystems and organisms*. New York, NY: Pergamon Press: 210–220.
- Carman, K.R.; Fleeger, J.W.; Means, J.C.; Pomarico, S.M.; McMillan, D.J.** 1995. Experimental investigation of the effects of polynuclear aromatic hydrocarbons on an estuarine sediment food web. *Marine Environmental Research*. 40:289–318.
- Catallo, W.J.; Gambrell, R.P.** 1987. The effects of high levels of polycyclic aromatic hydrocarbons on sediment physicochemical properties and benthic organisms in a polluted stream. *Chemosphere*. 16(5):1053–1060.
- Cerniglia, C.E.** 1984. Microbial metabolism of polycyclic aromatic hydrocarbons. *Advanced Applied Microbiology*. 30: 31–71.

- Cerniglia, C.E.; Heitkamp, M.A.** 1989. Microbial degradation of polycyclic aromatic hydrocarbons (PAH) in the aquatic environment. p. 41–68. In: Varanasi, U. ed. Metabolism of polycyclic aromatic hydrocarbons in the aquatic environment. Boca Raton, FL: CRC Press, Inc.
- Christensen, E.R.; Li, A.; Razak, I.A. [and others].** 1997. Sources of polycyclic aromatic hydrocarbons in sediments of the Kinnickinnic River, Wisconsin. *Journal of Great Lakes Research*. 23(1): 61–73.
- Colwell, R.R.** 1986. Microbial ecology studies of biofouling of treated and untreated wood pilings in the marine environment. Final Report. Office of Naval Research: U.S. Navy; Contract. N00014–75–C–0340 P0003. 22 p.
- Colwell, R.R.; Seesman, R.A.** 1976. Progress report on Roosevelt roads pilings project, preliminary work. Reston, VA: American Wood Preservers Institute.
- Davenport, R.; Spacie, A.** 1991. The acute phototoxicity of harbor and tributary sediments from lower Lake Michigan. *Journal of Great Lakes Research*. 17(1): 51–56.
- DeLaune, R.D.; Gambrell, R.P.; Pardue, J.H.; Patrick, Jr., W.H.** 1990. Fate of petroleum hydrocarbons and toxic organics in LA coastal environments. *Estuaries*. 13(1): 72–80.
- Dickhut, R.M.; Gustafson, K.E.** 1995. Atmospheric wash-out of polycyclic aromatic hydrocarbons in the southern Chesapeake Bay region. *Environmental Science Technology*. 29: 1518–1525.
- Dobroski, C.J.; Epifanio, C.E.** 1980. Accumulation of benzo(a)pyrene in a larval bivalve via trophic transfer. *Canadian Journal of Fisheries and Aquatic Sciences*. 37: 2318–2322.
- Driscoll, S.K.; Harkey, G.A.; Landrum, P.F.** 1997. Accumulation and toxicokinetics of fluoranthene in sediment bioassays with freshwater amphipods. *Environmental Toxicology and Chemistry*. 16(4): 742–753.
- Dunn, B.P.** 1980. Polycyclic aromatic hydrocarbons in marine sediments, bivalves, and seaweeds: analysis by high-pressure liquid chromatography In: Bjorseth, A.; Dennis, A.J., eds. Polynuclear aromatic hydrocarbons: chemistry and biological effects. Columbus, OH: Battelle Press: 367–377.
- Dunn, B.P.; Stich, H.F.** 1976. Monitoring procedures for chemical carcinogens in coastal waters. *Journal of the Fisheries Research Board of Canada*. 33: 2040–2046.
- Eaton, P.; Zitko, V.** 1978. Polycyclic aromatic hydrocarbons in marine sediments and shellfish near creosoted wharf structures in Eastern Canada. *International Council for the Exploration of the Sea*. E:25: 1–6.
- Eisler, R.** 1987. Polycyclic aromatic hydrocarbon hazards to fish, wildlife, and invertebrates: a synoptic review. Final report 11. Washington, DC: U.S. Department of the Interior—Contaminant Hazard Reviews. Laurel, MD: U.S. Fish and Wildlife Service, Patuxent Wildlife Research Center. 81 p.
- Environment Canada.** 1992. Creosote impregnated waste materials. Background technical report. Konasewich, D., N. Hutt, and G.E. Brudermann. ed. Edmonton, Alberta, Canada: Environment Canada, Western and Northern Region. 111 p. plus appendices.
- EPA.** 1980. Ambient water quality criteria for polynuclear aromatic hydrocarbons. Rep. 440/5–80–069. Washington, DC: U.S. Environmental Protection Agency. 180 p.
- EPA.** 1993. Sediment quality criteria for the protection of benthic organisms: Fluoranthene. EPA-822-R-93-012. Washington, DC: U.S. Environmental Protection Agency, Office of Science and Technology.
- EPA.** 2003a. Method 625-Base/nuetrals and acids. In: Methods for organic and chemical analysis of municipal and industrial wastewater. Washington, DC: U.S. Environmental Protection Agency. <http://www.epa.gov/waterscience/methods/guide/methods.html>.
- EPA.** 2003b. Method 8310-Polynuclear aromatic hydrocarbons. In: Test methods for evaluating solid wastes. Physical chemical methods. Washington, DC: U.S. Environmental Protection Agency. <http://www.epa.gov/epaoswer/hazwaste/test/main.htm>
- Gagne, F.; Blaise, C.** 1993. Hepathic metallothionein level and mixed function oxidase activity in fingerling rainbow trout (*Onchorhynchus mykiss*) after acute exposure to pulp and paper mill effluents. *Water Research*. 27: 1669–1682.
- Gala, W.R.; Giesy, J.P.** 1992. Photo-induced toxicity of anthracene to the green alga, *Selenastrum capricornutum*. *Arch. Environ. Contamination Toxicology* 23: 316–323.
- Godsy, E.M.; Goerlitz, D.F.; Grbić-Galić, D.** 1992. Methanogenic biodegradation of creosote contaminants in natural and simulated ground-water ecosystems. *Ground Water GRWAAP*. 30(2): 232–242.
- Goyette, D.; Boyd, J.** 1989. Distribution and environmental impact of selected benthic contaminants in Vancouver Harbour, BC. 1985–1987. Environment Canada, Environmental Protection Pacific, and Yukon Regional Program Rep. 89–02. North Vancouver, British Columbia, Canada: Environment Canada. 99 p.
- Goyette, D.; Brooks, K.M.** 1999. Creosote evaluation: phase II, Sooke Basin study—baseline to 535 days post construction—1995–1996. Rep. PR98–04. North Vancouver, British Columbia, Canada: Environment Canada. 568 p.

- Grifoll, M.; Selifonov, S.A.; Chapman, P.J.** 1994. Evidence for a Novel Pathway in the Degradation of Fluorene by *Pseudomonas* sp. Strain F274. *Applied and Environmental Microbiology*. 60(7): 2438–2449.
- Haitzer, M.; Abbt–Braun, G.; Traunspurger, W.; Steinberg, C.E.W.** 1999. Effects of humic substances on the bioconcentration of polycyclic aromatic hydrocarbons: correlations with spectroscopic and chemical properties of humic substances. *Environmental Toxicology and Chemistry*. 18(12): 2782–2788.
- Harkey, G.A.; Young, T.M.** 2000. Effect of soil contaminant extraction method in determining toxicity using the Microtox® assay. *Environmental Toxicology and Chemistry*. 19(2): 276–282.
- Hart, J.L.** 1973. Pacific fishes of Canada. Bulletin—Fisheries Research Board of Canada. Vol. 180. 730 p.
- Hatch, A.C.; Burton, G.A., Jr.** 1998. Effects of photoinduced toxicity of fluoranthene on amphibian embryos and larvae. *Environmental Toxicology and Chemistry*. 17(9): 1777–1785.
- Herbes, S.E.; Schwall, L.R.** 1978. Microbial transformation of polycyclic aromatic hydrocarbons in pristine and petroleum contaminated sediments. *Applied and Environmental Microbiology*. 35: 306–316.
- Hoffman, E.J.; Mills, G.L.; Latimer, J.S.; Quinn, J.G.** 1984. Urban runoff as a source of polycyclic aromatic hydrocarbons to coastal waters. *Environmental Science and Technology*. 18: 580–587.
- Hoffman, E.J.; Latimer, J.S.; Hunt, C.D. [and others].** 1985. Stormwater runoff from highways. *Water Air Soil Pollution*. 25(4): 349–364.
- Horness, B.H.; Lomax, D.P.; Johnson, L.L.; Myers, M.S.; Pierce, S.M.; Collier, T.K.** 1998. Sediment quality thresholds: Estimates from hockey stick regression of liver lesion prevalence in English sole (*Pleuronectes vetulus*). *Environmental Toxicology and Chemistry*. 17(5): 872–882.
- Huang, X.D.; Dixon, D.G.; Greenberg, B.M.** 1993. Impacts of UV radiation and photomodification on the toxicity of PAHs to the higher plant *Lemna gibba* (Duckweed). *Environmental Toxicology and Chemistry*. 12: 1067–1077.
- Huggett, P.A.; Van Veld, P.A.; Smith, C.L. [and others].** 1992. The effects of contaminated sediments in the Elizabeth River. In: Burton, G.A., ed. *Sediment toxicity assessment*. Lewis Publications: 403–430.
- Ingersoll, C.G.; Haverland, P.S.; Brunson, E.L. [and others].** 1996. Calculation and evaluation of sediment effect concentrations for the amphipod *Hyaella azteca* and the midge *Chironomus riparius*. *Journal of Great Lakes Research*. 22: 602–623.
- Ingram, L.L.; McGinnis, G.D.; Gjovik, L.R.; Roberson, G.** 1982. Migration of creosote and its components from treated piling sections in a marine environment. In: *Proceedings of the American Wood-Preservers' Association*. 78: 120–127.
- Jackim, E.; Lake, C.** 1978. Polynuclear aromatic hydrocarbons in estuarine and nearshore environments. In: Wiley, M.L., ed. *Estuarine interactions*. New York, NY: Academic Press: 415–428.
- Johnsen, S.** 1987. Interactions between polycyclic aromatic hydrocarbons and natural aquatic humic substances. Contact time relationship. *The Science of the Total Environment*. 67: 269–278.
- Johnson, L.L.; Myers, M.S.; Goyette, D.; Addison, R.F.** 1994. Toxic chemicals and fish health in Puget Sound and the Strait of Georgia. In: Wilson, R.C.H.; Beamish, R.J.; Aitkens, F.; Bell, J., eds. *Review of the marine environment and biota of Strait of Georgia, Puget Sound and Juan de Fuca Strait: Proceedings of the BC/Washington symposium on the Marine environment; 1994 January 13 and 14*. Canadian Technical Report of Fisheries and Aquatic Sciences No. 1948: 304–329.
- Johnston, W.R.; Harrison, R.M.** 1984. Deposition of metallic and organic pollutants alongside the M6 motorway. *Science of the Total Environment*. 33: 119–127.
- Jones, D.S.; Suter, G.W., II; Hull, R.N.** 1997. Toxicological benchmarks for screening contaminants of potential concern for effects on sediment-associated biota: 1997 Rev. Rep. ES/ER/TM-95/R4. Oak Ridge, TN: U.S. Department of Energy Office of Environmental Management under budget and reporting code EW 20. 31 p.
- Kanaly, R.A.; Bartha, R.** 1999. Cometabolic mineralization of benzo(a)pyrene caused by hydrocarbon additions to soil. *Environmental Toxicology and Chemistry*. 18(10): 2186–2190.
- Khalili, N.R.; Scheff, P.A.; Holsen, T.M.** 1995. PAH source fingerprints for coke ovens, diesel and gasoline engines, highway tunnels and wood combustion emissions. *Atmospheric Environment*. 29(4): 533–542.
- Krylov, S.N.; Huang, X.; Zeiler, L.F. [and others].** 1997. Mechanistic quantitative structure-activity relationship model for the photoinduced toxicity of polycyclic aromatic hydrocarbons: I. Physical model based on chemical kinetics in a two-compartment system. *Environmental Toxicology and Chemistry*. 16(11): 2283–2295.
- Lamar, R.T.; Davis, M.W.; Dietrich, D.M.; Glaser, J.A.** 1994. Treatment of a pentachlorophenol- and creosote-contaminated soil using the lignin-degrading fungus *Phanerochaete sordida*- a field demonstration. *Soil Biology and Biochemistry*. 26:1603–1611.

- Landrum, P.F.; Giesy, J.P.; Oris, J.T.; Allred, P.M.** 1987. Photoinduced toxicity of polycyclic aromatic hydrocarbons to aquatic organisms. In Vandermeulen, J.H.; Hrudy, S., eds. Oil in freshwater: chemistry, biology, countermeasure technology. Elmsford, NY: Pergamon Press: 304–318.
- Landrum, P.F.; Eadie, B.J.; Faust, W.R.** 1992. Variation in the bioavailability of polycyclic aromatic hydrocarbons to the amphipod *Diporeia* (spp.) with sediment aging. Environmental Toxicology and Chemistry. 11: 1197–1208.
- Larsen, P.F.; Gadbois, D.F.; Johnson, A.C.** 1986. Polycyclic aromatic hydrocarbons in Gulf of Maine sediments: distributions and mode of transport. Marine Environmental Research. 18: 231–244.
- Lawrence, J.F.; Weber, D.F.** 1984. Determination of polycyclic aromatic hydrocarbons in some Canadian commercial fish, shellfish, and meat products by liquid chromatography with confirmation by capillary chromatography-mass spectrometry. Journal of Agricultural and Food Chemistry. 32: 789–794.
- Lipkin, R.** 1993. Cosmic dust can ferry in organic molecules. Science News. 144: 278.
- Long, E.R.; MacDonald, D.D.; Smith, S.L.; Calder, F.D.** 1995. Incidence of adverse biological effects within ranges of chemical concentrations in Marine and Estuarine sediments. Environmental Management. 19(1): 81–97.
- Long, E.R.; Fiel, L.J.; MacDonald, D.D.** 1998. Predicting toxicity in marine sediments with numerical sediment quality guidelines. Environmental Toxicology and Chemistry. 17(4): 714–727.
- Lowe, D.M.; Pipe, R.K.** 1985. Cellular responses in the mussel *Mytilus edulis* following exposure to diesel oil emulsions: Reproductive and nutrient storage cells. In: Heath, G.W.; Moore, M.N.; Stegeman, J.J., eds. Responses of the marine organism to pollutants. Marine Environmental Research, Special Issue. 17(2–4): 234–237.
- Lytle, T.F.; Lytle, J.S.** 1985. Pollutant transport in Mississippi Sound. Ocean Springs, Mississippi: Gulf Coast Research Laboratory. 127 p.
- Malins, D.C.; Krahn, M.M.; Myers, M.S. [and others].** 1985. Toxic chemicals in sediments and biota from a creosote-polluted harbor: Relationships with hepatic neoplasms and other hepatic lesions in English sole *Parophrys vetulus*. Carcinogenesis. 6: 1463–1469.
- Mallet, L.; Priou, M.L.; Leon, M.** 1972. Biosynthesis and biodegradation of the polycyclic aromatic hydrocarbon benzo-3, 4-pyrene in the sediments of the Bay of Saint-Malo. In: Mallet, L., ed. Pollution des Mers par les Hydrocarbures Polybenzeniques du Type Benzo-3, 4-pyrene: 159–163. (In French).
- Marcus, J.M.; Stokes, T.P.** 1985. Polynuclear aromatic hydrocarbons in oyster tissue around three coastal marinas. Environmental Contamination Toxicology Bulletin. 35: 835–844.
- Maruya, K.A.; Risebrough, R.W.; Horne, A.J.** 1997. The bioaccumulation of polynuclear aromatic hydrocarbons by benthic invertebrates in an intertidal marsh. Environmental Toxicology and Chemistry. 16(6): 1087–1097.
- Masclat, P.; Hoyau, V.; Jaffrezo, J.L.; Legrand, M.** 1995. Evidence for the presence of polycyclic aromatic hydrocarbons in the polar ice of Greenland. Analisis. 23: 250–252.
- McConkey, B.J.; Duxbury, C.L.; Dixon, D.G.; Greenberg, B.M.** 1997. Toxicity of PAH photooxidation product to the bacteria *Photobacterium phosphoreum* and the duckweed *Lemna gibba*: Effects of phenanthrene and its primary photoproduct, phenanthrenequinone. Environmental Toxicology and Chemistry. 16(5): 892–899.
- Meador, J.P.; Stein, J.E.; Reichert, W.L.; Varanasi, U.** 1995. Bioaccumulation of polycyclic aromatic hydrocarbons by marine organisms. Reviews of Environmental Contamination and Toxicology. 143: 79–165.
- Mikkelsen, P.S.; Haefliger, M.; Ochs, M. [and others].** 1996. Experimental assessment of soil and groundwater contamination from two old infiltration systems for road runoff in Switzerland. In: Hamilton, R.S.; Harrison, R.M., eds. Highway and urban pollution. Science of the Total Environment. 189–190: 341–347.
- Millette, D.; Barker, J.F.; Comeau, Y. [and others].** 1995. Substrate interaction during aerobic biodegradation of creosote-related compounds: A factorial batch experiment. Environmental Science and Technology. 29(8): 1944–1952.
- Misitano, D.A.; Casillas, E.; Haley, C.R.** 1994. Effects of contaminated sediments on viability, length, DNA and protein content of larval surf smelt, *Hypomesus pretiosus*. Marine Environmental Research. 37: 1–21.
- Monson, P.D.; Call, D.J.; Cox, D.A. [and others].** 1999. Photoinduced toxicity of fluoranthene to northern leopard frogs (*Rana pipiens*). Environmental Toxicology and Chemistry. 18(2): 308–312.
- Moore, M.N., Livingston, D.R.; Widdows, J.** 1989. Hydrocarbons in marine mollusks: biological effects and ecological consequences. In: Varanasi, U., ed. Metabolism of polycyclic aromatic hydrocarbons in the aquatic environment. Boca Raton, FL: CRC Press, Inc. 321 p.
- Mueller, J.G.; Chapman, P.J.; Pritchard, P.H.** 1989. Creosote-contaminated sites—Their potential for bioremediation. Environmental Science and Technology. 23(10): 1197–1201.

- Mueller, J.G.; Middaugh, D.P.; Lantz, S.E.; Chapman, P.J.** 1991. Biodegradation of creosote and pentachlorophenol in contaminated groundwater: Chemical and biological assessment. *Applied and Environmental Microbiology*. 57(5): 1277–1285.
- Munoz, M.J.; Tarazona, J.V.** 1993. Synergistic effect of two- and four component combinations of the polycyclic aromatic hydrocarbons: phenanthrene, anthracene, naphthalene and acenaphthene on *Daphnia magna*. *Bulletin of Environmental Contamination Toxicology*. 50: 363–368.
- Neff, J.M.** 1979. Polycyclic aromatic hydrocarbons in the aquatic environment; sources, fates and biological effects. London: Applied Science Publishers LTD. ISBN: 0-85334-832-4.
- Neff, J.M.** 1982. Accumulation and release of polycyclic aromatic hydrocarbons from water, food, and sediment by marine animals. Duxbury, MA: Battelle New England Marine Research Laboratory.
- O'Connor, T.P.** 1991. Concentrations of organic contaminants in mollusks and sediments at NOAA national status and trend sites in the Coastal and Estuarine United States. *Environmental Health Perspectives*. 90: 69–73.
- Olive, P.L.** 1988. DNA precipitation assay: a rapid and simple method for detecting DNA damage in mammalian cells. *Environmental and Molecular Mutagenesis*. 11: 487–495.
- O'Malley, V.P.; Abrajano, T.A., Jr.; Hellou, J.** 1996. Stable carbon isotopic apportionment of individual polycyclic aromatic hydrocarbons in St. John's Harbour, Newfoundland. *Environmental Science and Technology*. 30(2): 634–639.
- Ott, F.S.; Harris, R.P.; O'Hara, S.C.M.** 1978. Acute and sublethal toxicity of naphthalene and three methylated derivatives to the estuarine copepod, *Eurytemora affinis*. *Marine Environmental Research*. 1: 49–58.
- Padma, T.V.; Hale, R.C.; Roberts, M.H., Jr.** 1998. Toxicity of water-soluble fractions derived from whole creosote and creosote-contaminated sediments. *Environmental Toxicology and Chemistry*. 17(8): 1606–1610.
- Pastorok, R.A.; Peek, D.C.; Sampson, J.R.; Jacobson, M.A.** 1994. Ecological risk assessment for river sediments contaminated by creosote. *Environmental Toxicology and Chemistry*. 13(12): 1929–1941.
- Payne, J.F.; Fancey, L.F.** 1989. Effect of polycyclic aromatic hydrocarbons on immune responses in fish: Change in melanomacrophage centers in flounder (*Pseudopleuronectes americanus*) exposed to hydrocarbon-contaminated sediments. *Marine Environmental Research*. 28: 431–435.
- Payne, J.F.; Kiceniuk, J.; Fancey, L.F. [and others].** 1988. What is a safe level of polycyclic aromatic hydrocarbons for fish: subchronic toxicity study on winter flounder (*Pseudopleuronectes americanus*). *Canadian Journal of Fisheries and Aquatic Sciences*. 34: 1983–1993.
- Perdriau, J.** 1964. Marine pollution by carcinogenic benzo-3,4-pyrene-type hydrocarbons—biological incidences. Pt. II. *Cahiers Océanographiques*. 16: 204–229. (In French.)
- Persaud, D.; Jaagumagi, R.; Hayton, A.** 1992. Guidelines for the protection and management of aquatic sediment quality in Ontario. Toronto, Canada: Ontario Ministry of the Environment. Water Resources Branch.
- Pierce, R.H., Jr.; Brent, C.R.; Williams, H.P.; Reeve, S.G.** 1977. Pentachlorophenol distribution in a fresh water ecosystem. *Environmental Contamination Toxicology Bulletin*. 18(2): 251–258.
- Polisini, J.M.** 1994. Toxicity of creosote to aquatic organisms. Sacramento, CA: California Department of Toxic Substances. 2 p.
- Prahl, F.G.; Crecellus, E.; Carpenter, R.** 1984. Polycyclic aromatic hydrocarbons in Washington coastal sediments: an evaluation of atmospheric and riverine routes of introduction. *Environmental Science and Technology*. 18: 687–693.
- PSWQA.** 1996. Recommended protocols for measuring selected environmental variables in Puget Sound. Olympia, WA: Puget Sound Water Quality Authority.
- Roesijadi, G.; Anderson, J.W.; Blaylock, J.W.** 1978. Uptake of hydrocarbons from marine sediments contaminated with Prudhoe Bay crude oil: Influence of feeding type of test species and availability of polycyclic aromatic hydrocarbons. *Journal of Fisheries Research Board of Canada*. 35: 608–614.
- Sayler, G.S.; Sherrill, T.W.** 1981. Bacterial degradation of coal conversion by-products (polycyclic aromatic hydrocarbons) in aquatic environments. Final Report. Office of Water Research and Technology, U.S. Department of Interior matching grant program project B-040 TENN. Knoxville, TN: Department of Microbiology and the Graduate Program in Ecology, University of Tennessee. 80 p.
- Sing, A.K.; Gin, M.F.; Ni, F.; Christensen, E.R.** 1993. A source-receptor method for determining non-point sources of PAHs to the Milwaukee Harbor Estuary. In: Christensen, E.R.; Edgington, D.N.; Giesy, J.P., eds. *Contaminated Aquatic Sediments*. 28(8–9): 91–102.
- Smith, S.L.; MacDonald, D.D.; Keenleyside, K.A. [and others].** 1996. A preliminary evaluation of sediment quality assessment values for freshwater sediments. *Journal of Great Lakes Research*. 22: 624–638.

- Southworth, G.R.; Beauchamp, J.J.; Schneider, P.K.** 1978. Bioaccumulation potential of polycyclic aromatic hydrocarbons in *Daphnia pulex*. *Water Research*. 12: 973–977.
- Stekoll, M.S., Clement, L.E.; Shaw, D.G.** 1980. Sublethal effects of chronic oil exposure on the intertidal clam, *Macoma balthica*. *Marine Biology*. 57: 51.
- Stringfellow, W.T.; Aitken, M.D.** 1994. Comparative physiology of phenanthrene degradation by two dissimilar pseudomonads isolated from a creosote-contaminated soil. *Canadian Journal of Microbiology*. 50(6): 432–438.
- Suter, G.W., II; Tsao, C.L.** 1996. Toxicological benchmarks for screening potential contaminants of concern for effects on aquatic biota: 1996 Rev. Rep. ES/ER/TM–96/R2. Oak Ridge, TN: U.S. Department of Energy, Risk Assessment Program, Health Sciences Research Division.
- Swartz, R.C.** 1999. Consensus sediment quality guidelines for polycyclic aromatic hydrocarbon mixtures. *Environmental Toxicology and Chemistry*. 18(4): 780–787.
- Swartz, R.C.; Kemp, P.F.; Schults, D.W. [and others].** 1989. Acute toxicity of sediment from Eagle Harbor, Washington, to the Infaunal Amphipod *Rhepoxynius abronius*. *Environmental Toxicology and Chemistry*. 8: 215–222.
- Swartz, R.C.; Schultz, D.W.; Ozretich, R.J. [and others].** 1995. Σ PAH: a model to predict the toxicity of polynuclear aromatic hydrocarbon mixtures in field-collected sediments. *Environmental Toxicology and Chemistry*. 14: 1977–1987.
- Swink, F.A.; Wilhelm, G.S.** 1994. *Plants of the Chicago region*, 4th ed. Indianapolis, IN: Indiana Academy of Science.
- Tagatz, M.E.; Plaia, G.R.; Deans, C.H.; Lores, E.M.** 1983. Toxicity of creosote-contaminated sediment to field and laboratory colonized estuarine benthic communities. *Environmental Toxicology and Chemistry*. 2: 441–450.
- Tang, J.; Alexander, M.** 1999. Mild extractability and bioavailability of polycyclic aromatic hydrocarbons in soil. *Environmental Toxicology and Chemistry*. 18(12): 2711–2714.
- United Nations University.** 2001. Table 11: A summary of the available sediment quality criteria and guidelines for the protection of aquatic life. In: *The water virtual learning center*. Waterloo, Ontario, Canada: UNU-The International Network on Water Environment and Health and the University of Waterloo. <http://wvlc.uwaterloo.ca/biology447/modules/module1/sedaquat3.html>.
- Varanasi, U.** 1989. *Metabolism of polycyclic aromatic hydrocarbons in the aquatic environment*. Boca Raton, FL: CRC Press. 321 p.
- Venkatesan, M.I.** 1988. Occurrence and possible sources of perylene in marine sediments—a review. *Marine Chemistry*. 25: 1–27.
- Vogelbein, W.K.; Fournie, J.W.; Van Veld, P.A.; Huggett, R.J.** 1990. Hepatic neoplasm's in the Mummichog *Fundulus heteroclitus* from a creosote-contaminated site. *Cancer Research*. 50: 5978–5986.
- Wade, M.M.; Connor, M.S.; Jop, K.M. [and others].** 1987. Summary evaluation of the environmental impact resulting from the use of creosoted pilings in the historic restoration of pier #2 at the Charleston Navy Yard. Final Report. Boston, MA: U.S. Department of the Interior, National Park Service, North Atlantic Region. 36 p.
- Wade, M.J.; Costa, H.J.; Boehm, P.D.** 1988. Exposure assessment of creosote in selected sediment and seawater samples collected in the vicinity of Piers #2 and #4 at the Charleston navy yard. Boston, MA: U.S. Department of the Interior, National Park Service, North Atlantic Region. 49 p. plus appendices.
- Wade, T.L.; Kennicutt, M.C., II; Brook, J.M.** 1989. Gulf of Mexico hydrocarbon seep communities: Pt. III. Aromatic hydrocarbon concentrations in organisms, sediments and water. *Marine Environmental Research*. 27: 19–30.
- Wakeham, S.G.; Schaffner, C.; Giger, W.** 1980. Polycyclic aromatic hydrocarbons in recent lake sediments—I. Compounds having anthropogenic origins. *Geochimica Cosmochimica Acta*. 44: 403–413.
- Wan, M.T.** 1991. Railway right-of-way contaminants in the lower mainland of British Columbia: Polycyclic aromatic hydrocarbons. *Journal of Environmental Quality*. 20: 228–234.
- Washington Department of Ecology.** 1995. Elliott Bay waterfront recontamination study—Volume 1: Field Investigation Report. Publication No. 95-335. Olympia, WA: Washington State Department of Ecology.
- Weinstein, J.E.; Oris, J.T.** 1999. Humic acids reduce the bioaccumulation and photoinduced toxicity of fluoranthene to fish. *Environmental Toxicology and Chemistry*. 18(9): 2087–2094.
- Wendt, P.H.; Van Dolah, R.F.; Bobo, M.Y. [and others].** 1994. A study of wood preservative leachates from docks in an estuarine environment. Final Report. Charleston, SC: South Carolina Department of Health and Environmental Control, Office of Ocean and Coastal Resource Management.
- West, W.R.; Smith, P.A.; Booth, G.M. [and others].** 1986a. Determination of genotoxic polycyclic aromatic hydrocarbons in a sediment from the Black River (Ohio). *Archives of Environmental Contamination and Toxicology*. 15: 241–249.

West, W.R.; Smith, P.A.; Stoker, P.W. [and others]. 1986b. Analysis and genotoxicity of a PAC-polluted river sediment. In: Cooke, M.; Dennis, A.J., eds. Polynuclear aromatic hydrocarbons: mechanisms, methods and metabolism. Columbus, OH: Battelle Press: 1395–1411.

White, J.C.; Hunter, M.; Nam, K. [and others]. 1999. Correlation between biological and physical availabilities of phenanthrene in soils and soil humin in aging experiments. *Environmental Toxicology and Chemistry*. 18(8): 1720–1727.

Widdows, J.; Bakke, T.; Bayne, B.L. [and others]. 1982. Responses of *Mytilus edulis* L. on exposure to the water accommodated fraction of North Sea oil. *Marine Biology*. 67: 15.

Widdows, J.; Donkin, P.; Evens, S.V. 1985. Recovery of *Mytilus edulis* L. from chronic oil exposure. *Marine Environmental Research*. 17: 250–253.

Wild, S.R.; Jones, K.C. 1995. Polynuclear aromatic hydrocarbons in the United Kingdom environment. A preliminary source inventory and budget. *Environmental Pollution*. 88(1): 91–108.

Zarembski, A.M. 1990. Wood tie life: Pt. I—Average tie life. *Railway Track and Structures*. 86: 17–18.

Appendix—Occurrence and Toxicity of PAH in the Environment

Sources of PAH in Aquatic Environments

Polycyclic aromatic hydrocarbons (PAH) are formed by a variety of processes, including indirect and direct biosynthesis, fossil fuel production and distribution, and incomplete combustion of organic matter associated with forest fires, transportation systems, home heating, and energy production. Once formed, PAH can be transported into an aquatic environment by a number of pathways including fossil fuel distribution, stormwater runoff, sewage effluent, and atmospheric deposition. These compounds have been ubiquitous in earth's biosphere for eons (Masclat and others 1995) and indeed are likely to be present throughout the cosmos (Lipkin 1993).

Biosynthesis

Indirect biosynthesis of PAH occurs when extended quinones and related polycyclic materials (mostly plant and animal pigments) are exposed to the reducing conditions found in anoxic sediments. The resulting PAH tend to accumulate in the sediments where they were formed. De novo biosynthesis of PAH by aerobic and anaerobic bacteria, fungi, and plants is controversial. However, Mallet and others (1972) and Brisou (1972) concluded that both aerobic and anaerobic bacteria can biosynthesize benzo[a]pyrene (B[a]P) and certain other PAH using fatty acids, sterols, plant pigments, and aliphatic terpenes as substrates. In most cases where PAH biosynthesis has been reported, accumulation of PAH in the organisms purported to have synthesized them could also have been attributed to uptake of PAH from exogenous sources.

In light of all the literature reviewed, it appears that PAH biosynthesis may occur to a limited extent under special environmental conditions when necessary bacterial growth substrates are present. Eisler (1987) suggested that, on a global scale, biosynthesis annually contributes 2.7 Gg (6 million lb) of PAH to aquatic environments.

Fossil Fuels

Fossil fuels including peat, coal, and petroleum are relatively rich in complex assemblages of PAH. These compounds reach aquatic environments through surface runoff, waste water, and as a result of petroleum spillage. Eisler (1987) estimates that spilled petroleum contributes 170 Gg (375 million lb) of PAH to aquatic environments each year. This source overwhelms all others in terms of global inputs.

Pyrolysis

Pyrolysis of organic matter at temperatures between 400°C and 2,000°C results in the generation of a wide variety of PAH. Reducing conditions (insufficient oxygen) in pyrolytic environments favor PAH production. Forest and grass fires, industrial processes, heating, power generation, and petroleum refining release significant amounts of PAH into the atmosphere. These products of combustion are subject to chemical- and photo-oxidation. However, their residence time in the atmosphere is long enough to allow wide dispersal, and they are a major source of PAH to aquatic and terrestrial environments. According to Eisler (1987), forest and prairie fires together with agricultural burning release nearly 33 Gg (72 million lb) of PAH into the atmosphere each year. This is three times the amount from all other pyrolytic sources combined.

Petrolytic

Johnston and Harrison (1984) reported that B[a]P deposition along a United Kingdom motorway was 2.8 µg/m²/week. B[a]P is approximately 0.5% to 2.5% of some PAH mixtures, and a direct extrapolation suggests that the total PAH loading along a well-used highway may be 560 µg/m²/week. Winter levels of PAH in coastal areas are higher than summer levels. This is attributed to increased pyrolytic input from the burning of fossil fuels for power generation and heating (Bouloubassi and Saliot 1991). Broman and others (1990) suggested that primary PAH inputs in the Baltic region were from exhaust emissions associated with automobiles, domestic heating, refuse incineration plants, ships, and aircraft.

Neff (1979) reported that little-used (224 km) motor oil contained 6.4 µg B[a]P/L equivalent to nearly 1.28 mg/L total PAH. Dunn and Stich (1976) found up to 22 mg/L B[a]P in well-used crankcase oil. This is equivalent to 4.4 parts per thousand (g/L) total PAH. In 1989, Washington State had 4.2 million vehicles registered. These vehicles produced 79 ML (21 million gallons) of used crankcase oil each year. That may represent as much as 284 Mg (625,000 lb) of PAH available to the environment.

Industrial and Domestic Storm and Wastewater

Industrial and domestic storm and wastewaters are rich in PAH. Secondary sewage treatment removes some PAH, but most are released to aquatic environments through sewage treatment plant outfalls. Eisler (1987) notes that untreated, raw sewage contains 100 to 500 µg/L total PAH and sewage sludge contains 200 to 1,750 µg/L PAH. Goyette and Boyd (1989) recorded sediment PAH concentrations of 17 µg TPAH/g dry sediment near a major combined sewage–stormwater outfall discharging into Vancouver Harbor. Sediment PAH concentrations in the central areas of the harbor were consistently in the range of 2 to 5 µg TPAH/g dry sediment.

Hoffman and others (1984) noted that stormwater runoff from urban areas and highways accounted for 71% of the high molecular weight (HMW) PAH and 36% of the total PAH loading to Narragansett Bay in Rhode Island. Hoffman and others (1985) found that highway runoff contributed 96.3% of PAH loading to the Pawtuxet River in Rhode Island while sewage contributed 3.67% and industry added the remaining 0.03%. More than 30% of all pyrolytic PAH in the coastal sediments of Washington State are supplied by riverine transport of suspended particulate materials, while direct atmospheric input accounts for a maximum of 10% (Prah and others 1984).

Observed Levels of PAH in Terrestrial Environments

Wild and Jones (1995) and Bradley and others (1994) characterized baseline and urban soil concentrations of PAH in the United Kingdom and New England soils, respectively. Bradley and others (1994) also reported significantly higher ($\alpha = 0.05$) concentrations of PAH near pavement (21.9 µg/g) compared with areas not near pavement (8.3 µg/g). Their data are summarized in Table 25.

Concentrations of PAH in rural soils were spread evenly across the 10 individual compounds evaluated by Wild and Jones (1995). The suite of PAH in urban and forest soils was dominated by phenanthrene, fluoranthene, benz(a)anthracene/chrysene, pyrene, benzo(b)fluoranthene, and benzo(ghi)perylene. Minor amounts of anthracene, acenaphthene, fluorene, and naphthalene were observed. Soil concentrations of PAH in New England cities were dominated by benzo(b or k)fluoranthene (3.16 µg/g), fluoranthene (3.047 µg/g), pyrene (2.398 µg/g), chrysene (1.841 µg/g), phenanthrene (1.838 µg/g), B[a]P, and benzo(a)anthracene in order of decreasing mean concentration.

Table 25—Mean soil concentrations of PAH observed in terrestrial environments. All values are in micrograms PAH per kilogram dry soil weight

Soil source	Mean PAH concentration	Upper 95th percentile PAH concentration
Boston ^a	18.7	35.9
Providence ^a	16.8	23.5
Springfield ^a	19.1	29.9
United Kingdom ^b		
Rural soils	0.2	
Urban soils	4.2	
Forest soils	4.8	

^aSum of 17 individual PAH compounds from Bradley and others (1994).

^bSum of 10 individual PAH compounds from Wild and Jones (1995).

Observed Concentrations of PAH in Aquatic Environments

Because of the many natural sources, polycyclic aromatic hydrocarbons are ubiquitous in aquatic and terrestrial environments. However, significantly increased levels have been recorded in all environments during the last two centuries. Wakeham and others (1980) observed total PAH concentrations of 1.0 µg/g in deep core sediments representing historical deposits beginning 3,000 years before present from Lake Washington in Washington State. Venkatesan (1988) reported perylene concentrations as high as 4 µg/g in pristine, but anoxic, marine sediments. Neff (1979) found low (<1 to 2 µg/L) levels of PAH in the water column of pristine areas and similarly low sediment contamination concentrations of <0.050 µg/g. Eisler (1987) and Cerniglia and Heitkamp (1989) found similar distributions of sediment PAH levels. Levels in pristine areas of Alaska, Africa, and the Amazon Basin ranged from 0.005 to 0.544 µg/g. There are numerous natural sources for this baseline PAH level including volcanoes, forest and prairie fires, natural oil seeps, and biosynthesis.

The 1.0 µg PAH/g recorded in Lake Washington sediment cores dating from 3,000 years before present until the middle of the 19th century by Wakeham and others (1980) increased to 7 to 8 µg/g after European settlement in the 1860s. There are many potential point and nonpoint sources of PAH associated with urban and industrial areas. These include electrical power generation, home heating, internal combustion engine exhaust, lubricating oils, tires, asphalt paving, etc. Christensen and others (1997) determined concentrations and sources of eight PAH in sediments of the Kinnickinnic River, in Wisconsin, as a function of time from 1895 until 1991. Sediments in the Kinnickinnic River are heavily contaminated with PAH at concentrations of 80 to 1,000 µg PAH/g dry sediment. Mean concentrations observed in dated cores declined from 423 µg/g in 1902 to 8 µg/g in 1991. The dominant PAH shifted from LMW compounds (average molecular weight = 179.3) in 1902 to higher molecular weight compounds in 1991 (average molecular weight = 206.4). Earlier sources were dominated by coal gasification and coking plants associated with the steel industry. Polycyclic aromatic hydrocarbons in more recent sediment deposits are mostly associated with highway runoff. A recent decline in atmospheric PAH deposition was also observed by Masclet and others (1995) who found that PAH concentrations in polar ice caps peaked during the period 1910 to 1940 and have subsequently declined.

On a broader scale, Neff (1979) reported PAH concentrations up to 15 µg/g associated with industrialized areas and/or human population centers and Wild and Jones (1995) observed a mean freshwater sediment concentration of 17.2 µg TPAH/g in the United Kingdom. Eisler (1987) reported sediment PAH concentrations associated with

urbanized and industrialized areas as high as 791 µg/g in the United Kingdom, and Cerniglia and Heitkamp (1989) measured sediment PAH levels up to 1.8 mg/g at an oil refinery outfall in Southampton, England. Sediment PAH concentrations in other industrialized areas ranged from 0.198 to 232 µg/g. These historic depositions are nearly all associated with industrial activities working with wood, coal, and petroleum products. These point sources have declined since the middle of the 20th century. However, as previously noted, anthropogenic sources of PAH are currently dominated by transportation systems and are associated with internal combustion engines, lubricants, tires, and asphalt and tars used in road surfacing (Mikkelsen and others 1996). In addition to highway runoff, atmospheric deposition is a primary mode of PAH transport to aquatic environments (Larsen and others 1986, Bouloubassi and Saliot 1991). Table 26 summarizes Eisler's (1987) assessment of PAH loading to aquatic environments from the most common sources.

There is a consistent thread running through research and reviews by Bouloubassi and Saliot (1991), Neff (1979), Eisler (1987), and others cited earlier. According to the sediment record, PAH have been ubiquitous on earth for at least several thousand years with pre-industrial age concentrations generally less than 1 to 5 µg TPAH/g. Worldwide, urban areas, particularly those adjacent to roadways, have much higher baseline sediment PAH levels in the range of 0.5 to 50 mg PAH/kg dry soil or sediment. Heavily industrialized areas may have TPAH concentrations of 10 to several hundred mg TPAH/kg. The major sources of PAH are atmospheric deposition, wastewater, storm water, and surface runoff associated with transportation systems.

Fate of PAH in the Environment

Polycyclic aromatic hydrocarbons form a family of compounds, and the routes of degradation and fates are different for the major classes of PAH. In water, PAH evaporate, disperse into the water column, become incorporated into bottom sediments, concentrate in aquatic biota, or experience chemical and biological degradation. Borthwick and Patrick (1982) estimated the chemical and biological half-life of the dissolved components of marine grade creosote at less than

Table 26—Global sources of PAH to aquatic environments^a

Source	PAH (Gg)
Petroleum spillage	170.00
Atmospheric deposition (from combustion)	50.00
Wastewater	4.40
Surface land runoff	2.94
Biosynthesis	2.70

^aEisler (1987).

one week in laboratory experiments. More recently, Bestari and others (1998a,b) observed an exponential decline in creosote-derived PAH released to microcosms. The concentration of PAH in these microcosms reached baseline levels by the end of their 84-day study.

The most important degradative processes for PAH in aquatic environments are photo-oxidation, chemical oxidation, and biological transformation by bacteria and animals (Neff 1979). Most PAH in aquatic environments are associated with particulate materials, and only about a third are present in dissolved form. Dissolved PAH will probably degrade rapidly through photo-oxidation (EPA 1980). They degrade most rapidly at higher concentrations, at elevated temperatures and oxygen levels, and at higher levels of solar irradiation. Different PAH vary significantly in their relative sensitivity to chemical and biological degradation.

Because of their low aqueous solubility and hydrophobic character, the higher molecular weight PAH readily adsorb to particulate materials and solid surfaces in water. The ultimate fate of PAH that accumulate in sediments is believed to be biotransformation and degradation by bacteria, fungi, and algae (EPA 1980, Borthwick and Patrick 1982, Cerniglia 1984, Boldrin and others 1993). Low molecular weight PAH, such as naphthalene, degrade rapidly, while the higher molecular weight PAH such as benz(a)anthracene and B(a)P are more resistant to microbial attack. Herbes and Schwall (1978) reported turnover times for naphthalene, anthracene, and benz(a)anthracene of 13, 62, and 300 h, respectively. Mueller and others (1991) found that natural microbial communities mineralized 94% of the LMW PAH in 14 days but only 53% of the HMW PAH were degraded during the same period. They also noted that the most rapid biodegradation of PAH occurred at the water-sediment interface. This is because prokaryotes oxidize PAH as a first step in metabolism. Deeper sediments usually contain little oxygen, thus inhibiting microbial metabolism.

Saylor and Sherrill (1981) and Cerniglia and Heitkamp (1989) summarized the available literature describing the half-life of PAH in aquatic environments. The results were highly variable and depended on PAH species as well as a range of environmental and biological factors such as temperature, the presence of cometabolites, the nature of the microbial community, and the availability of oxygen. A broad range of bacteria and fungi have been observed to rapidly degrade numerous light and heavy molecular weight PAH (Grifoll and others 1994; Stringfellow and Aitken 1994; Cerniglia and Heitkamp 1989). Bacterial communities in polluted areas metabolize PAH more quickly than communities in unpolluted areas, and lighter weight PAH are metabolized more quickly than heavier PAH (Herbes and Schwall 1978). Naphthalene has a short turnover time (hours to days), whereas the five ringed B(a)P has a long turnover time (years under unfavorable conditions). However, Kanaly and Bartha (1999) demonstrated significant biodegradation

of B(a)P in the presence of complex hydrocarbon mixtures. Crude oil, distillates of heating oil, jet fuel, and diesel fuel supported up to 60% mineralization of 80 μg B(a)P/g soil in 40 days. Millette and others (1995) also demonstrated the interdependence and cometabolism of mixtures of creosote-derived PAH following an initial lag time of 5 to 7 days during which the natural microbial community was selected for those phenotypes capable of more efficiently metabolizing PAH. In that study, 60% to 75% of the phenanthrene was mineralized within 30 days. This suggests that in the presence of complex cometabolites, phenanthrene, which comprises 19.4% of new creosote oil, may be rapidly lost from the matrix of PAH that move from creosote-treated wood into natural environments.

Bogan and Lamar (1995) showed that white rot basidiomycetes are able to degrade a broad spectrum of intermediate (phenanthrene) and heavier creosote-derived PAH. Mueller and others (1989) provide an excellent review of bioremediation technologies designed to remove PAH, including the HMW compounds, from creosote-contaminated sites.

Ingram and others (1982) observed that the concentration of creosote in leaching vats increased to greater than 700 $\mu\text{g}/\text{L}$ in the first 72 h and then decreased to less than 34 $\mu\text{g}/\text{L}$ at the end of 20 days. They attributed that decrease to bacterial metabolism of the LMW PAH that was leached from the pile sections in the study.

Tagatz and others (1983) noted that creosote concentrations decreased by 42% during an 8-week period in sediments artificially contaminated as part of their mesocosm studies. They attributed the decrease to microbial metabolism.

Neff (1979) attempted to integrate the degradative processes associated with PAH removal from aquatic environments. He concluded that the residence time of PAH in water is brief. The lower molecular weight aromatics (benzene to phenanthrene) are removed primarily by evaporation and microbial activity. Higher molecular weight PAH are removed mainly by sedimentation and photo-oxidation. Degradation of PAH by animals in the water column is of minor importance. In nutrient rich, biologically active, aerobic sediments, the degradation of PAH is dramatically increased by healthy bacterial and fungal communities. However, in anaerobic sediments, the heavier molecular weight PAH (four through seven rings) may persist for years.

PAH From Different Sources

Khalili and others (1995), Sing and others (1993), O'Malley and others (1996), Dickhut and Gustafson (1995), and Bender and others (1987) characterized the spectrum of PAH compounds associated with a variety of sources. In Figure 24, their data are combined with results for weathered PAH deposits in sediments adjacent to marine piling installed in a pristine marine environment (Goyette and Brooks 1999) As seen in Figure 24, coal contains significant quantities of

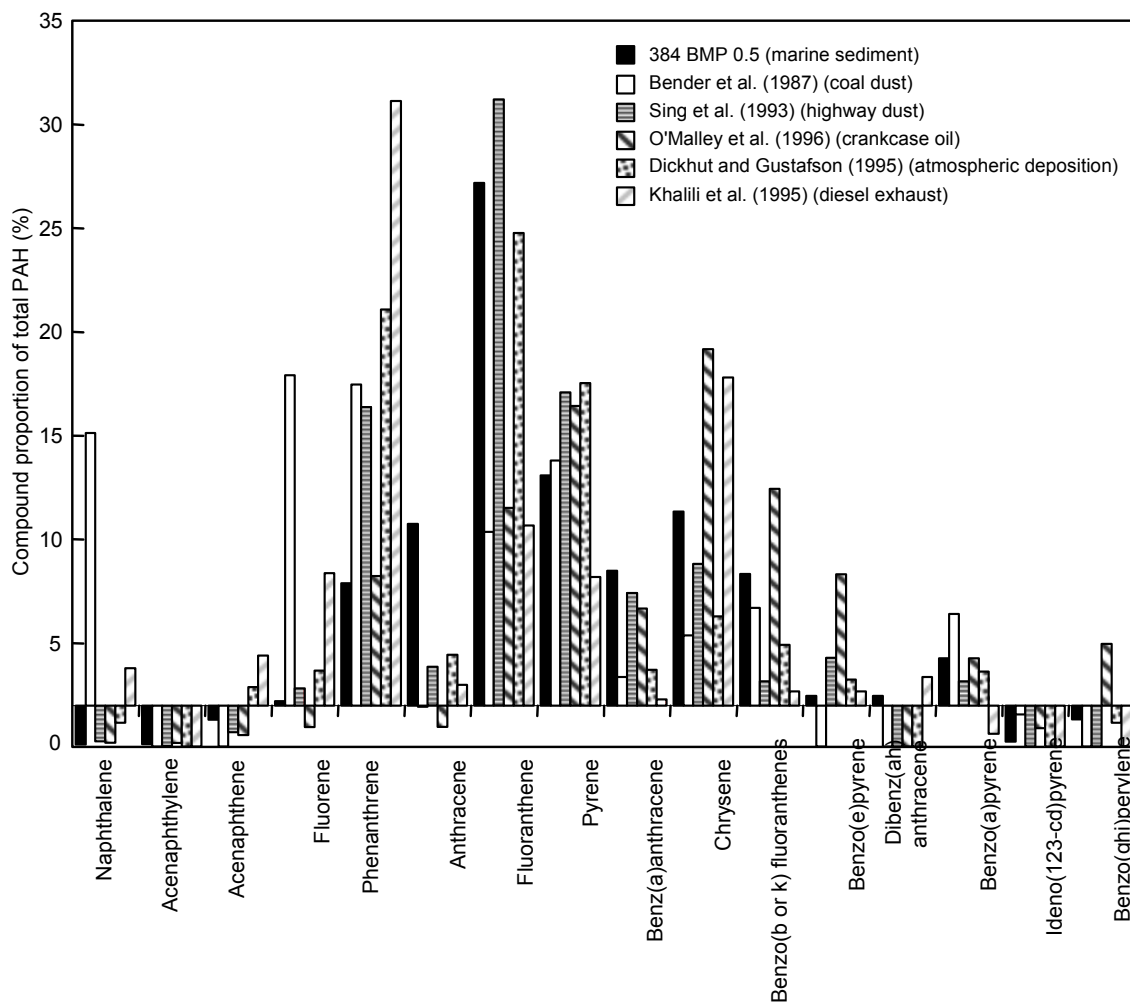

Figure 24—PAH profiles associated with a variety of sources.

intermediate and low molecular weight (LMW) PAH including naphthalene, fluorene, phenanthrene, fluoranthene, and pyrene. The other sources involve PAH subjected to high temperatures such as from crankcase oil, diesel exhaust, and atmospheric deposition. Sediment samples collected 384 days following construction of a creosote-treated dolphin are presented in black columns in Figure 24. The creosote spectrum is dominated by fluoranthene and other intermediate-weight PAH (phenanthrene to benzo (b or k) fluoranthene). Low molecular weight PAH represented less than 2% of the total PAH, and compounds heavier than benzo(b or k)fluoranthene contributed little to the overall spectrum. In contrast, the PAH in crankcase oil are dominated by HMW compounds. The relative proportions of phenanthrene and fluoranthene are reversed in highway runoff compared with creosote. The suite of compounds associated with atmospheric deposition is similar to creosote-derived PAH. However, atmospheric deposition typically results in a spatially uniform distribution at levels less than 1.0 µg PAH/g.

The fingerprint of PAH from creosote-treated wood changes with time and weathering. The degradation of creosote by photo-oxidation and microbial catabolism is well studied and verified. Brooks (1997a) reviewed the microbial degradation of PAH and developed algorithms for estimating the degradation of sedimented PAH as a function of temperature and ambient oxygen levels. Goyette and Brooks (1999) installed three six-piling, creosote-treated dolphins in a pristine area of Sooke Basin, British Columbia. The study periodically collected sediment samples for PAH, grain size, total organic carbon, and sulfide and biological analysis for 1,540 days. The PAH composition of unused creosote oil, creosote pressed from the treated wood immediately following treatment, and the sediments were determined in this study. The results are presented in Figure 25. The proportion of LMW compounds decreased significantly during the treating process. The PAH lost from freshly treated piling were rich in the intermediate-weight compounds, particularly phenanthrene and fluoranthene. As sedimented PAH weathered,

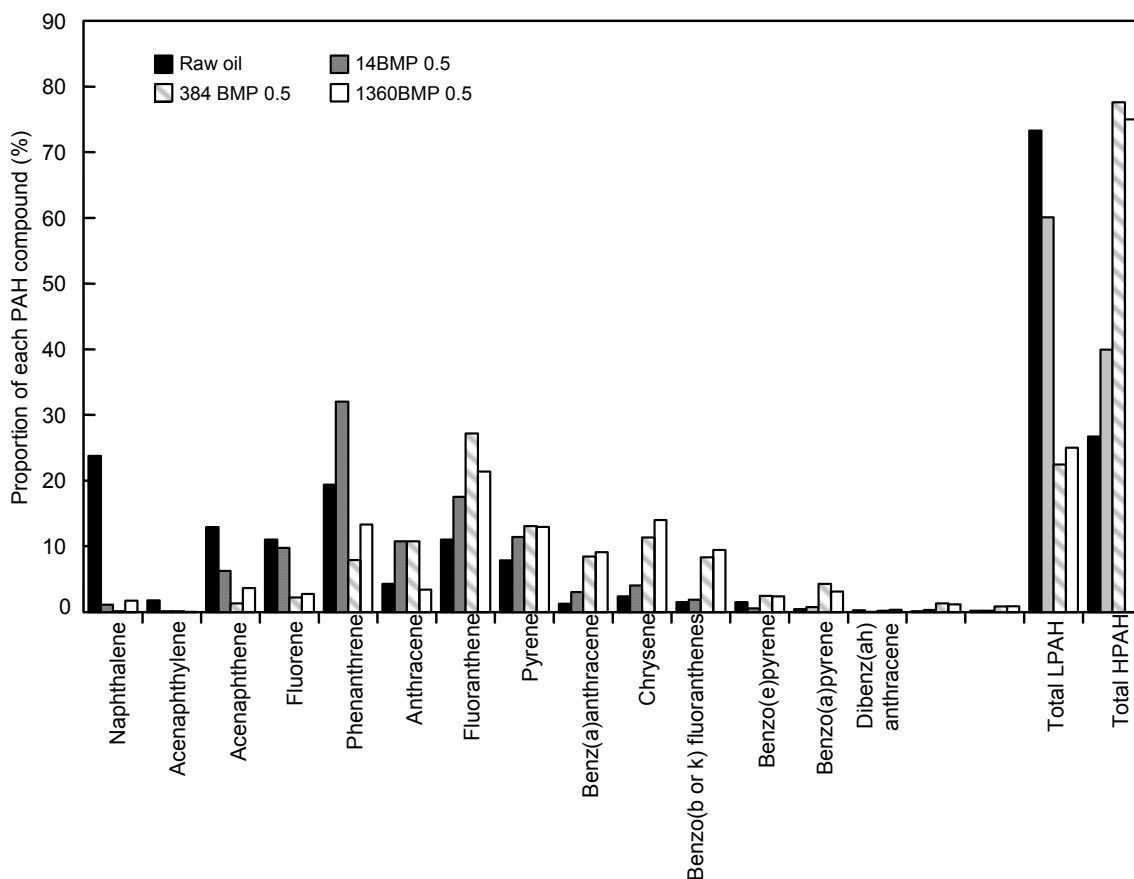

Figure 25—Changing composition of weathering creosote in marine sediments.

phenanthrene was reduced but remained at about 13% of the total. Fluoranthene was degraded but at a slower rate than phenanthrene. At the end of 4 years, the creosote-derived PAH were dominated by fluoranthene. However, phenanthrene, pyrene, benzo(a)anthracene, chrysene, and benzo(b and k)fluoranthenes each represented approximately 10% of the total. The PAH compounds lighter than phenanthrene were weathered to very low concentrations, and those heavier than benzo(b and k) fluoranthene remained at low concentrations similar to those found in the raw oil and the newly treated wood.

Bestari and others (1998a,b) observed similar results in microcosm studies with either unused creosote oil or pressure-treated piling. In their studies, the PAH spectrum also shifted from low to heavier weight compounds. At the end of 84 days, sediments contaminated with liquid creosote by Bestari and others (1998a) were dominated by phenanthrene, fluoranthene, pyrene, and chrysene with very low concentrations of other compounds. Bestari and others (1998b) observed a similar PAH distribution at the end of 68 days in microcosms containing piling freshly treated with creosote.

While fingerprinting 18 possible sources of PAH associated with the Exxon Valdez oil spill in Alaska, Burns and others (1997) also found that the suite of PAH in sediments next to

creosote-treated piling in Crab Bay, Alaska, were dominated by phenanthrene, fluoranthene, pyrene, and chrysene. All of these studies found very low proportions of PAH compounds heavier than benzo(b or k)fluoranthene.

Wan (1991) examined sediments adjacent to operating railway rights of way in British Columbia and adjacent to a creosoted wharf structure in Nova Scotia. The spectra are similar except that more naphthalene was found adjacent to the railway rights of way than adjacent to the creosote-treated structures located in marine environments. That is probably due to the presence of diesel fuel and coal dust, both of which contain higher proportions of the lower molecular weight PAH and are associated with rail lines in the lower mainland of British Columbia (Fig. 26).

The preceding discussion is important in that it clearly demonstrates that the suite of PAH associated with recent (<4 year old) losses from treated wood are dominated by phenanthrene, fluoranthene, pyrene, and chrysene with lesser amounts of benz(a)anthracene and benzo(b or k) fluoranthene. Other compounds are found only at very low concentrations. It also demonstrates the complexity of attributing environmental PAH to a single source, such as railroad ties.

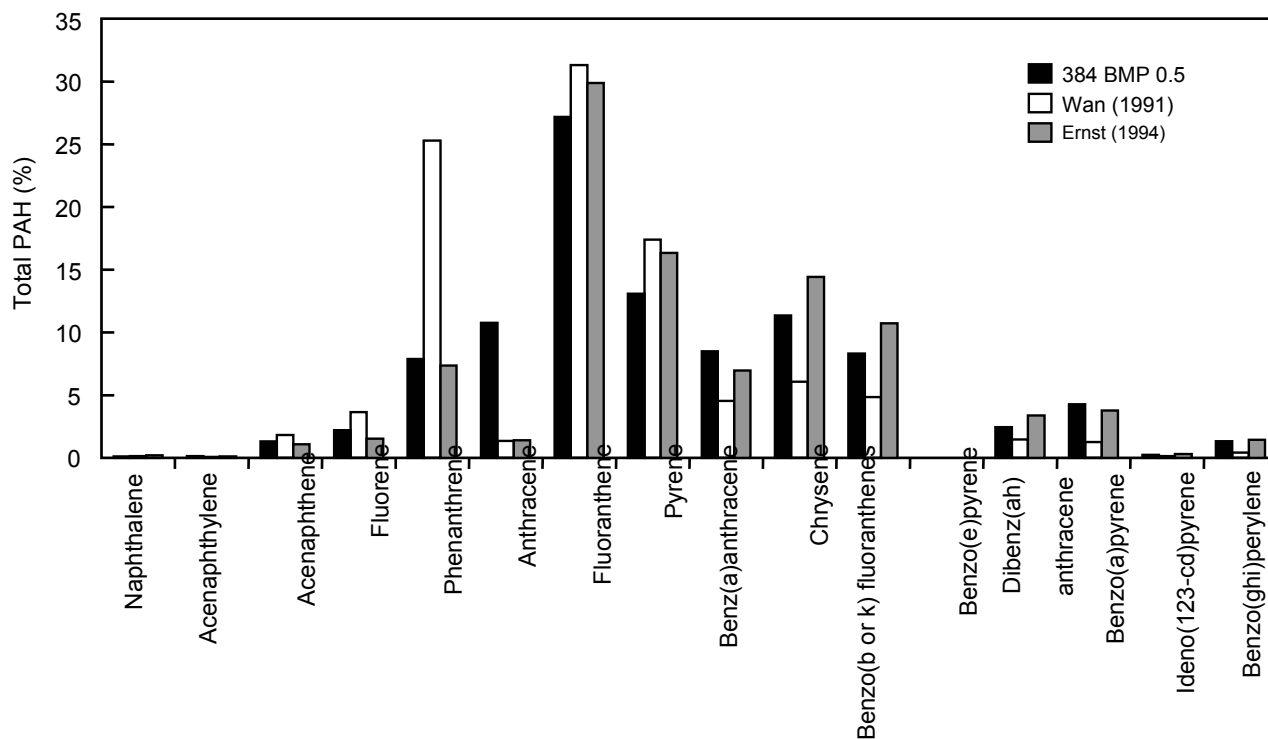

Figure 26—Proportion of PAH compounds associated with creosote-treated piling (384 BMP 0.5) and railway rights-of-way in the lower mainland of British Columbia (Wan 1991) with sedimented PAH adjacent to a creosote wharf structure in Nova Scotia (Ernst, W., 1994, personal communication).

Weathering of Creosote-Derived PAH

Ingram and others (1982) observed increasing PAH concentrations for approximately 72 h in their static leaching tests of creosote-treated piling. The concentrations then declined exponentially. They hypothesized that the decreases were due to photodegradation and catabolism by microbes. In a more recent article, Bestari and others (1998a,b) observed significant decreases in dissolved PAH concentrations in a series of static leaching tests that immersed between 0.5 and 6 piling in 12,000-L microcosms. Initial concentrations as high as 97 µg TPAH/L in these static systems decreased to less than 10 µg TPAH/L at the end of 85 days with no significant increases in sediment concentrations or uptake by the polyethylene liners used in the microcosms. Bestari and others also attributed the exponential declines to photodegradation and microbial catabolism. Colwell (1986) identified the bacteria responsible for the degradation of creosote-derived PAH in marine environments. Since then, a rich literature has evolved describing the microbial catabolism of PAH by bacteria and fungi. Much of that literature is devoted to the growing field of biological remediation at PAH-contaminated sites. For instance, Godsey and others (1992) and Mueller and others (1991) described the biodegradation of creosote contaminants by methanogenic bacteria in anaerobic environments, Lamar and others (1994) reported on the degradation of creosote by fungi, and DeLaune

and others (1990) discussed the fate of hydrocarbons, including creosote, in Louisiana coastal environments. DeLaune and others (1990) noted that microbial degradation determines the fate of sedimented creosote more than other factors, and they discussed factors determining catabolic rates.

Partitioning of PAH Between Dissolved and Particulate Phases in Water

Polycyclic aromatic hydrocarbons are hydrophobic—that is one reason they form sheens. Individual PAH solubility is generally inversely correlated with molecular weight. The LMW compounds have solubilities varying from 32 mg/L for naphthalene to 0.044 mg/L for anthracene. The HMW compounds vary between 0.26 mg/L for fluoranthene and 0.00026 mg/L for benzo[ghi]perylene.

Goyette and Brooks (1999) determined the PAH composition in raw creosote oil, in piling, in surface sheens found during construction, and in sediments during a period of 535 days following construction. Naphthalene, the most soluble of the PAH, comprised 24% of the raw oil, but only 10% of the PAH in treated wood. The remaining 14% of the naphthalene was lost during the treating process, which involves final steaming of the wood at high temperature under vacuum. This process removes excess oil from the wood cells and preferentially removes the more volatile LMW compounds. As shown in Figure 25, this resulted

in a PAH spectrum in treated wood that was dominated by intermediate-weight compounds (acenaphthene, phenanthrene, anthracene, fluoranthene, and pyrene). The heavier compounds represented a very small fraction of both new oil and the preservative retained in the treated wood. The point is that the treated wood contains a PAH spectrum that is dominated by intermediate-weight compounds with low water solubility (3.42 mg/L for acenaphthylene decreasing to 0.13 mg/L for pyrene).

Water column concentrations of total PAH measured by Battelle within 15 cm of the six-piling dolphins in Sooke Basin using semipermeable membrane devices (SPMD) were 17.87, 22.94, and 30.76 ng/L (parts per trillion). These values were slightly higher than the 13.37 ng/L measured at the Sooke Basin reference station. The values observed were consistent with PAH concentrations measured in marine mussels (*Mytilus edulis edulis*) grown at the same distance of 15 cm from the piling and with known bioconcentration factors (BCF). The sum of toxic units (TU) (Swartz and others 1995) in water immediately adjacent to this dense cluster of piling was 0.000745, which is well below the recommended benchmark of 0.186 TU necessary to protect aquatic organisms.

Based on the results for water and sediment PAH analyses presented in Goyette and Brooks (1999), the authors hypothesized that PAH are transported to sediments in microparticles or microliter-sized droplets. Preliminary laboratory studies (Brooks, unpublished data) have substantiated this hypothesis. Microliter quantities of PAH released beneath the air–water interface settled to the bottom of graduated cylinders with speeds that appear consistent with those predicted by Stokes' equation. Furthermore, the particles settled into either quartz sand or crushed oyster shell substrates and remained intact for at least 2 years. Small quantities of creosote oil injected above the air–water interface formed sheens on the water's surface. These sheens remained intact until the water was disturbed as it would be by waves. The sheen then broke up into small, irregularly shaped particles that settled to the bottom and worked their way into the sediments. Milliliter quantities of creosote oil injected under the air–water interface settled to the bottom of glass vials where they retained their ellipsoidal shape for up to 2 years. If the vials were vigorously shaken, the larger droplets broke up into smaller particles, some of which adhered to the sides of the vials.

This hypothesis, if substantiated, will significantly change the approach to assessing toxicity of creosote-contaminated sediments. Infauna, rather than being subjected to an environment that is uniformly contaminated by a diffuse pattern of PAH, would be confronted with an environment that is predominantly uncontaminated with foci of high contamination. In this scenario, exposure is best described stochastically with consideration for possible avoidance or attraction to the PAH foci by various organisms. This hypothesis

would explain the extreme patchiness of PAH concentrations found in association with PAH-contaminated sediments. It would also help explain why mixtures of PAH, like creosote, are found to be less toxic than an additive toxicity assumption would predict (Tagatz and others 1983, California EPA 1994). Lastly, this hypothesis would explain the presence of square-centimeter-sized microspheres observed to depths of 4 cm in creosote-contaminated sediments at Sooke Basin when those sediments were exposed to air.

Axelmann and others (1999) observed ten times more PAH in the colloidal phase and five times more PAH in the particulate phase than in the dissolved phase. The concentration of PAH in the dissolved phase represented less than 10% of the PAH in the water column. Wade and others (1987) found creosote-associated PAH only in surface sheen samples collected at the Charlestown, Virginia, Navy Yard. They could find no creosote-associated polynuclear aromatic hydrocarbons in the water column immediately adjacent to the piers. In addition, no observable response was seen in sea urchin (*Arbacia punctulata*) bioassays using water from either Pier #2 or #4. All of this evidence indicates that creosote-derived PAH do not dissolve in open aquatic environments at concentrations that cause adverse biological effects. In contrast, the adverse biological effects associated with high concentrations of sedimented PAH are well known.

Biological Effects Associated With PAH

As seen in the previous section, PAH are ubiquitous in aquatic and terrestrial environments. They have been present for eons at baseline levels ranging from less than 1 µg/g to perhaps 4 or 5 µg/g. They are a natural part of our environment, and organisms have evolved to coexist with them. Polycyclic aromatic hydrocarbons are all hydrophobic as expressed by the octanol–water partition coefficients ($\log K_{ow}$), which increased from 3.33 for naphthalene to 6.22 for benzo(ghi)perylene. The biological consequences of this hydrophobicity are that PAH tend to be found only at very low dissolved concentrations and that they bind to dissolved and particulate organic matter (POM) in water and sediments.

Polycyclic aromatic hydrocarbons are bioconcentrated from the dissolved fraction in water, and much higher levels are found in plant and animal tissues than are found in the dissolved state. Once PAH are taken up by living organisms, several enzyme systems have evolved to excrete them or to break them down and then to excrete the intermediate metabolic products. Some of these intermediate metabolites are carcinogenic, and high environmental concentrations of PAH can lead to chronic stress and/or increased risk for cancer in organisms exposed to sediment PAH concentrations greater than 7 to 10 µg TPAH/g in sediments with 1.0% organic carbon. The following sections of this report review some aspects of the biological response to PAH.

Bioconcentration, Bioaccumulation, and Biomagnification of PAH

Bioconcentration and bioaccumulation of contaminants is of special importance because some aquatic species, most notably bivalves, have demonstrated an ability to rapidly bioconcentrate some contaminants in water to high tissue levels. The concern is that persistent contaminants may move up the food chain, biomagnifying to higher concentrations in each trophic level, until contaminants found at nontoxic levels in the ambient environment reach concentrations where they do cause stress and disease. For effective biomagnification and movement of contaminants through the food chain, several conditions must be met. First, organisms must have the ability to bioconcentrate low levels of contaminants from the water column or to bioaccumulate PAH from sediments or their food. Second, these contaminants, or their toxic metabolic intermediates, must be retained, unaltered, in the tissues of the organism until it falls prey to an animal at a higher trophic level.

There are a number of factors that mitigate biomagnification. If contaminants are not absorbed, they cannot accumulate. Numerous organisms, particularly arthropods and vertebrates, have the ability to rapidly metabolize and/or to excrete organic contaminants. The gut, liver, kidney, and gall bladder are common sites of PAH concentration, metabolism, and excretion in vertebrates. If the contaminants are rapidly excreted or metabolized to nontoxic compounds, then the chain is broken and biomagnification is not effective in passing contaminants upward through the food chain. DDT is an excellent example of a persistent compound that was bioconcentrated from low levels in the water to higher levels, first in plankton, then in fish, and finally in bird populations, with devastating consequences.

Neff (1982) reported that most aquatic organisms bioconcentrate PAH from low concentrations in the ambient water to higher tissue levels. Bioconcentration factors are predicted by the octanol-water partition coefficients (K_{ow}) associated with individual PAH compounds.

Bivalve mollusks, particularly the commercially important mussel (*Mytilus edulis*) and oysters of the genera *Ostrea* and *Crassostrea* have received far more attention than other aquatic invertebrates, plants, or fish. They are excellent subjects for monitoring pollutants because they filter substantial quantities of water over large and highly permeable gills. For these reasons, mussels have been the subject of numerous studies such as the Global Mussel Watch Program. Many of these studies have focused on the accumulation of metals and the carcinogenic molecule B[a]P.

Benzo[a]pyrene levels recorded in Neff (1979) for uncontaminated areas fall in the undetectable to perhaps 50 µg/L range. Dunn and Stich (1975 (in Dunn and Stich 1976)) recorded tissue levels averaging 59 µg/g in mussels from areas associated with marinas and higher levels averaging

402 µg/g in mussels growing on creosote-treated pilings. Dobroski and Epifanio (1980) found that direct uptake of B[a]P from seawater by diatoms was much greater than the rate of trophic transfer from the diatoms to clam larvae.

Eisler (1987) recorded elevated PAH concentrations, especially benzo(a)anthracene, chrysene, fluorene, phenanthrene, and pyrene, in oyster tissues and sediments from the vicinity of marinas. These levels were notably higher in cooler months when lipids and glycogen were being stored to prepare for spawning (Marcus and Stokes 1985).

For mussels, the general trend towards lower levels of HMW PAH relative to the levels in associated sediment suggests an uptake mechanism that involves the solution of PAH in water. Supporting this hypothesis is the observed rapid turnover and shorter half-life of the more soluble, LMW PAH (Dunn 1980). This suggests that the more soluble (and more bioavailable) LMW PAH are effectively removed from sediments and metabolized by bivalves. The HMW PAH (associated with chronic stress and genetic disorders) have reduced bioavailability in sediments because of their lower solubility. However, once absorbed, HMW PAH are more slowly metabolized by bivalves.

The PAH levels in fish are usually low because this group rapidly metabolizes all PAH (Lawrence and Weber 1984, West and others 1986a,b) or they excrete them. High concentrations of PAH are typically found in the gut, liver, and bile. Raw fish from unpolluted or moderately polluted water seldom contains detectable amounts of PAH. However, smoking and cooking of fish can increase PAH content to significant levels.

Neff (1982) reported BCF for several PAH in the clam *Rangia cuneata*. The BCF values, which ranged from 6.1 to 32, are for PAH dissolved in water. Eisler (1987) has summarized BCF values from the literature. The BCF values he reports contradict his assertion that bivalves accumulate PAH more rapidly than fish. For all of the values given in his review, the average BCF values were

Bivalves	82 ($n = 8$)
Fish	6,844 ($n = 34$)

Eisler (1987) reported BCF values from 6 to 236 in the clam *Rangia cuneata*. Four of the five values were less than 33. For fish, BCF values ranged from 44 to 82,916 with most values in the hundred to thousand times range.

Biaccumulation of PAH From Sediments

The ultimate fate of most HMW PAH deposited in aquatic environments is sedimentation. Working in Prudhoe Bay, Alaska, Roesijadi and others (1978) examined the accumulation of crude oil and specific PAH from oil-contaminated sediments by three infaunal invertebrate species, the sipunculid worm *Phascolosoma agassizii* and the clams *Macoma inquinata* and *Protothaca staminea*. They found that the

efficiency of PAH uptake from sediments was much lower than from water. Bioaccumulation factors for uptake of the four PAH from contaminated sediments were 0.2 or less, indicating no significant bioconcentration of PAH by this route. However, BCF for uptake of these four PAH from seawater were in the 10.3 to 1,349 range, indicating a low to moderate potential for bioconcentration from water. Similarly, Driscoll and others (1997) observed steady-state biota-sediment accumulation factors (BSAF) of 0.16 to 0.61 for the freshwater amphipod *Hyalella azteca* and 0.34 to 0.82 for another amphipod *Diporeia* spp.

Eisler (1987) suggested that bivalves readily take up PAH from sediments. This hypothesis is contradicted by numerous studies. O'Connor (1991) found that at 117 National Status and Trend Sites where there were both mollusks and fine-grained sediments, the average ratio of mollusk tissue to sediment concentration was only 1.2 for total PAH. He also noted that mollusks accumulate the LMW (and more highly soluble) PAH to a greater extent than the HMW PAH (ratio of mollusk tissue to sediment PAH concentration 2.0 and 0.64, respectively). Eaton and Zitko (1978) noted that PAH levels in clams and mussels were two orders of magnitude below those detected in sediments. Neff (1979) cites Perdriau's (1964) finding that in no case did benthic animals contain elevated levels of B[a]P compared with sediment concentrations. Tissue concentrations in the animals were, on average, 36% of the sediment concentrations.

The bioavailability of PAH is affected by sediment physico-chemistry including the proportion of organic carbon, which binds PAH making them unavailable, and the sediment texture, which affects uptake by sediment ingesting detritivores (Meador and others 1995). Maruya and others (1997) estimated the uptake of sediment contaminants by determining the ratio of contaminant concentration in organism lipid to the concentration in sediment on an organic carbon basis. This work is important in that most modern sediment benchmarks evoked for purposes of protecting biota from excess PAH contamination are based on sediment organic carbon. Maruya and others (1997) observed BSAF varying between 0.0069 and 5.4, confirming the low potential for uptake of PAH from sediments.

Johnsen (1987) observed that numerous PAH, including anthracene, fluoranthene, pyrene, and benzo(a)anthracene, form strong bonds with natural aquatic humic substances. The strength of these bonds increased with time and with the octanol-water partition coefficient. In other words, the HMW compounds were more tightly bound than the LMW compounds. White and others (1999) and Tang and Alexander (1999) observed that phenanthrene, anthracene, fluoranthene, and pyrene became more tightly bound to sediments and soil humin as time passed. Their hypothesis was confirmed using both mild extractive techniques designed to release only the bioavailable fraction of the PAH and by measured uptake kinetics in plants and animals. Similarly,

Haitzer and others (1999) observed decreasing PAH BCFs in the nematode *Caenorhabditis elegans* in the presence of increased levels of humic substances in soils and sediments. Bioconcentration factors for pyrene decreased from 12,000 in the absence of dissolved organic carbon (DOC) to 5,000 to 7,000 at DOC values greater than 10 mg/L. The decreases for B(a)P were even more dramatic, decreasing from about 35,000 to <5,000 at DOC levels exceeding 15 to 20 mg/L. Similar results were obtained by Weinstein and Oris (1999) for fluoranthene. They found that the fluoranthene BCF decreased from 9,054 in the absence of dissolved humic material to 2,810 when the water contained 5.0 mg carbon per liter. The median lethal time for photoenhanced fluoranthene at a concentration of 4.8 µg/L to fathead minnows (*Pimephales promelas*) increased from about 55 h in the absence of dissolved humic material to about 100 h in the presence of one or more milligram humic acid per liter. These authors also reported strong attenuation of ultraviolet (UV)-A and moderate attenuation of UV-B as a function of increasing humic substances in water.

Accumulation of PAH from sediment may be attributed in large part to uptake of PAH desorbed from sediment particles into interstitial water. Numerous studies cited above and in Neff (1982) and Meador and others (1995) led to the general conclusion that sediment-adsorbed PAH are not readily assimilated by benthic animals. This hypothesis is further supported by Swartz and others (1989) who concluded that the concentration of chemicals in interstitial water is the primary determinant of sediment toxicity, not the bulk concentration in the sediment. Both the historical literature and more recent research support the importance of organic carbon in binding aromatic hydrocarbons and reducing their bioavailability.

Depuration of PAH

Southworth and others (1978) found a half-life of less than 1 h for all PAH metabolized by *Daphnia pulex*. Jackim and Lake (1978) reported that the half-life of PAH in most bivalves is on the order of 2 to 16 days. These studies suggest that PAH are either rapidly metabolized or excreted, at least by these species.

Biomagnification of PAH in the Food Chain

Neff (1979) reported that the annelid, *Neanthes arenaeodentata*, had little, if any, ability to accumulate 2-methylnaphthalene from its food. However, the situation is quite different in marine crustaceans and fish where uptake from food was much more efficient than uptake from water. Arthropods (crabs, amphipods, shrimp, etc.) rapidly accumulate LMW PAH and very rapidly excrete or metabolize these compounds. The half-life of B[a]P in *Callinectes sapidus* was 6 days. Neff's (1979) conclusion was that all results dramatically demonstrated the importance of metabolism in eliminating PAH from contaminated crustaceans. Broman and others (1990) examined the trophic transfer of PAH in a study involving seston, the blue mussel (*Mytilus edulis*), and

the eider duck (*Somateria mollissima*). Contrary to biomagnification, they observed decreasing PAH concentrations with increasing trophic levels.

Bioaccumulation Summary

Aquatic organisms are able to efficiently bioconcentrate PAH from the water column. It appears that direct transfer from sediments to organisms living within and on those sediments is minimal. Benthic organisms rarely contain higher concentrations of PAH than are found in the sediments in which they live. PAH are rapidly metabolized and excreted by vertebrates and arthropods. In bivalves, which do not metabolize PAH as efficiently as arthropods and vertebrates, the half-life of most PAH examined was in the range of 2 to 16 days. These data suggest that PAH are not persistent in the tissues of aquatic species and that movement of PAH through food chains to higher trophic levels is minimal, if it occurs at all.

Neff (1979) concluded the following: "From the limited data available, it would appear that there are large interspecific differences in ability to absorb and assimilate PAH from food. Polychaete worms have a very limited ability to absorb and assimilate PAH, whereas fish absorption of PAH from the gut is limited and variable depending on species of fish, the PAH, and possibly the food matrix in which PAH is administered. Crustaceans, on the other hand, apparently readily assimilate PAH from contaminated food. In all cases where assimilation of ingested PAH was demonstrated, metabolism and excretion of PAH were rapid. Thus, the potential for food chain biomagnification of PAH seems to be limited. For such biomagnification to occur, the material must be readily absorbed from food, and once assimilated, it must be relatively resistant to metabolism or excretion."

Creosote and PAH Toxicity in Aquatic Environments

Aquatic organisms have been exposed to baseline levels of PAH for eons. The diversity of life in aquatic environments attests to aquatic species ability to tolerate baseline PAH levels of 1 to 2 µg/L in water and 0.010 to 4.0 µg/g in sediments. Thus, it is important to determine the level where PAH cause significant stress and/or pathological responses at the organismal and population levels. In answering that question, we will consider two types of toxicity: acute and chronic.

Acute toxicity causes observable physiological lesions and is usually measured by mortality. PAH can interact with cells in several ways to cause toxic responses. As an example, they may bind reversibly to lipophilic sites in the cell and thereby interfere with cellular processes. Potentially impacted and important intracellular organelles include lysosomes, which contain strong enzymes important in intracellular digestion of complex organic molecules and in the immune response. Increased lysosomal membrane permeability can result in the unregulated flow of these

Table 27—Acute toxicity of various PAH to marine organisms as measured by 96-h LC₅₀ values. All values are in µg/L

Species	96-h LC ₅₀
Mysids (<i>Mysidopsis bahia</i>) ^a	18 to 21
Oysters (<i>Crassostrea virginica</i>) ^a	700
Pink shrimp (<i>Penaeus duorarum</i>) ^a	240
Sheepshead minnows (<i>Cyprinodon variegatus</i>) ^a	3,500
Mosquito fish (<i>Gambusia affinis</i>) ^a	150,000 naphthalene
Mosquito fish (<i>Gambusia affinis</i>) ^b	1,180,000 toluene
Dungeness crab larvae (<i>Cancer magister</i>) ^b	8 naphthalene
Dungeness crab larvae (<i>Cancer magister</i>) ^b	170 naphthalene

^aBorthwick and Patrick (1982)

^bNeff (1979)

enzymes into the cytoplasm or blood serum with pathological consequences including autophagy. Eisler (1987) noted that the LMW, unsubstituted PAH compounds, containing two or three rings, such as naphthalene, fluorene, phenanthrene, and anthracene, have significant acute toxicity to some organisms, whereas the HMW, four- to seven-ring aromatics do not. However, these heavier molecules contain numerous potentially carcinogenic and mutagenic intermediates.

Dissolved PAH Toxicity in Marine Environments

A common measure of acute toxicity is the concentration of a toxicant that causes 50% mortality in a test population within some specified period of time (often 96 h). This measurement is referred to as the 96-h LC₅₀. Borthwick and Patrick (1982) and Neff (1979) reported 96-h LC₅₀ values for several marine animals. These are summarized in Table 27. Interestingly, in Neff's (1979) discussion of the effects of PAH on aquatic animals, he cites Caldwell and others' (1977) finding that continuous exposure to dissolved naphthalene concentrations of 19 to 170 µg/L had no effect on the survival of Dungeness crab larvae. No explanation was given for the very low (8 ppb) value reported in Neff's (1979) paper or for the differences in the values reported. One might expect that exogenous factors contributed to the differences. The LC₅₀ values reported in the literature for most organisms and PAH compounds are in the 500 to 5,000 ppb range. Neff (1979) found that in all but a few cases, the concentrations of aromatic hydrocarbons that are acutely toxic to aquatic animals are several orders of magnitude higher than concentrations found even in the most heavily polluted marine and fresh waters. However, sediments from polluted regions may contain aromatic hydrocarbons at concentrations similar to or higher than those

that are acutely toxic. The limited bioavailability of sediment-adsorbed PAH undoubtedly renders them substantially less acutely toxic than dissolved PAH. He also noted that PAH-induced stress is cumulative and exacerbated by exogenous stress factors such as abnormal thermal and osmotic conditions.

PAH Toxicity in Freshwater

Because PAH heavier than naphthalene are so hydrophobic, they are generally found at extremely low concentrations in freshwater and have little potential to create acute or chronic stress in aquatic communities. As will be seen, this statement is not necessarily true for sedimented PAH. Suter and Tsao (1996) and Swartz (1999) summarized conventional benchmarks for priority contaminants in freshwater. These values are summarized in micrograms per liter in Table 28. Because daphnids and dragonflies (*Odonata*) are both arthropods, the lowest daphnid chronic values are presented from Suter and Tsao (1996). Additional freshwater acute toxicity data provided in EPA (1993) are summarized in Table 29.

The data presented in Table 29 suggest that at least some odonates are not particularly susceptible to PAH intoxication. As an example, *Ophiogomphus* spp. has a UV-photo-enhanced fluoranthene LC₅₀ of 109.7 µg/L. This UV-exposed acute value is much higher than the values of 1.0 to 3.0 µg UV-enhanced anthracene or fluoranthene per liter observed to cause mortality in other organisms. The point is that the available evidence suggests that this order may be more robust to PAH contamination than are other, more sensitive, species.

Toxicity associated with mixtures of compounds can be additive, antagonistic, or synergistic. This is true of mixtures of PAH, which appear to have slightly less than additive toxicity. For instance, the LC₅₀ for rainbow trout (*Oncorhynchus mykiss*) associated with fluoranthene is >90.5 ppb. The LC₅₀ for rainbow trout subjected to whole creosote oil is almost 10 times higher at 880 µg/L (Polisini 1994). Padma and others (1998) examined the toxicity of the water soluble fraction of creosote to the mysid (*Mysidopsis bahia*) and found median lethal concentrations (expressed as total identified aromatic hydrocarbons) of 180 µg/L.

Photoenhanced PAH Toxicity

The interaction of UV light with anthracene and fluoranthene resulted in modified compounds with increased toxicity to aquatic organisms, at least in laboratory experiments. Landrum and others (1987) reported photoenhanced anthracene LC₅₀ of 12 µg/L in bluegill sunfish and 1.2 µg/L for *Daphnia pulex*. The authors were unsure whether the UV light sensitized the target tissues or if it modified the anthracene to a more toxic compound. The observed toxicity was reported to be 400 times greater in the presence of UV than in its absence. Davenport and Spacie (1991) extended these results by demonstrating increased toxicity to *Daphnia magna* associated with a suite of PAH extracted from

Table 28—Summary of consensus LC₅₀ values for sediment PAH compounds from Swartz (1999) and lowest daphnid dissolved PAH chronic values reported by Suter and Tsao (1996).

Compound	Swartz (1999) LC ₅₀ (µg/g)	Suter & Tsao (1996) lowest daphnid chronic value (µg/L)
Naphthalene	71	1,163
Acenaphthylene	15	Not given
Acenaphthene	23	6,646
Fluorene	90	Not given
Phenanthrene	155	200
Anthracene	114	<2.1
Fluoranthene	371	15
Pyrene	481	Not given
Benz(a)anthracene	111	0.65
Chrysene	169	Not given
Benzo(b)fluoranthene	180	Not given
Benzo(k)fluoranthene	155	Not given
Benzo(a)pyrene	179	0.30
Low molecular weight PAH	468	
High molecular weight PAH	1,646	
Total PAH	2,114	

Table 29—U.S. Environmental Protection Agency (EPA 1993) LC₅₀ values describing fluoranthene toxicity to freshwater arthropods

Species	Sediment LC ₅₀ (µg/g organic carbon)	Water LC ₅₀ (µg/L)
<i>Daphnia magna</i>		3.5
<i>Hyalela azteca</i>	500	44.9
<i>Chironomus tetans</i>	1,587	30.4
<i>Ophiogomphus</i> spp.		>178.5
<i>Ophiogomphus</i> spp. (UV exposed)		>109.7

Lake Michigan sediments. These authors reported that exposure of the sediment elutriates to UV did not result in increased toxicity in subsequent bioassays. Increased toxicity was observed only when the daphnids were cultured in the presence of PAH-contaminated elutriate and UV light. Concentrations of PAH in these tests were not reported. Krylov and others (1997) reported on a quantitative structure-activity relationship model predicting the photoenhanced toxicity of 16 PAH. Their model assumed that

biological stress is associated with PAH that are UV-modified outside the organism, with uptake of these modified PAH and with damage to a group of endogenous biomolecules necessary for photosynthesis in duckweed (*Lemna gibba*). Their model suggested that photoenhanced PAH toxicity is a function of several factors including the length of exposure to PAH and UV, the relative absorbance of simulated solar radiation by each PAH, the resulting quantum yield for formation of triplet-state PAH, and the rate of PAH photomodification. They found that toxicity associated with nine PAH compounds was dominated by the PAH modification constant and that the photosensitization constant was more important in describing toxicity for the remaining seven PAH. This work suggested that photoenhanced PAH toxicity is a function of the particular PAH compound's propensity for modification to a more toxic photoenhanced form and of the target organism's (or tissues') susceptibility to photosensitization. The photosensitization constant is probably particular to different taxa and to various life stages within taxa. This model provides relative toxicity data and not absolute data upon which to determine numerical estimates of toxicity. The authors concluded that photosensitization of target organism tissues and photomodification contribute additively (not synergistically) to photoenhanced PAH toxicity.

Gala and Giesy (1992) reported UV-enhanced anthracene toxicity in green alga (*Selenastrum capricornutum*). The 22-h EC_{50} (the concentration of material in water to which test organisms are exposed that is estimated to be effective in producing some sublethal response in 50% of the test organisms) for specific growth rate ranged from 37.4 to 3.9 μg anthracene per liter depending on the intensity of UV-A radiation. Huang and others (1993) observed similar results for the higher plant *Lemna gibba* exposed to anthracene, phenanthrene, or B(a)P in the presence of UV or simulated sunlight. These authors reported the relative toxicity of anthracene to be greater than phenanthrene, and both were more toxic than photomodified B(a)P. Growth inhibition was reported at values exceeding thresholds of approximately 200 μg anthracene per liter, 500 μg phenanthrene per liter, and 3,000 μg B(a)P/L. The lower toxicity of phenanthrene (compared with anthracene) was substantiated by McConkey and others (1997) who hypothesized that the photoenhanced toxicity of phenanthrene is associated with the intermediate product phenanthrenequinone. These authors reported an EC_{50} of 3,500 μg phenanthrene per liter in *Lemna gibba* in simulated solar radiation and 10,800 μg phenanthrene per liter in visible light (no UV). In contrast, the EC_{50} for the photomodified compound phenanthrenequinone was independent of the presence of UV at 530 to 570 $\mu\text{g}/\text{L}$.

Ankley and others (1995) demonstrated that increased UV-enhanced fluoranthene toxicity to *Lumbriculus variegatus* was a function of both dissolved PAH concentration and UV intensity. Oligochaete mortality increased above

approximately 29 μg fluoranthene per liter in low UV environments. Acute toxicity thresholds were lower under medium light intensity (8 $\mu\text{g}/\text{L}$) and lowest under high intensity UV (75.2 mW/cm^2 UV-A) radiation (4 $\mu\text{g}/\text{L}$). These authors noted that *L. variegatus* purifies fluoranthene and that the annelid's physiology includes repair mechanisms that decrease short-term toxicity during periods of darkness. Under medium light intensity (33.5 mW/cm^2 UV-A), mortality did not occur until after 26 h at a fluoranthene concentration of 60 $\mu\text{g}/\text{L}$. This is important because sunlight is intermittent, lasting for only about 16 h at temperate latitudes. Therefore, these values probably overestimate the photoenhanced toxicity of fluoranthene to this species. Monson and others (1999) observed similar responses in larval frogs (*Rana pipiens*) where increasing mortality was observed in exposures to 3.5 $\mu\text{g}/\text{L}$ following exposure to intense light for periods greater than 30 h. However, Hatch and Burton (1998) reported photoenhanced fluoranthene toxicity only at much higher levels in the same species. These authors reported EC_{50} concentrations of 276 μg fluoranthene per liter in *Rana pipiens*, 247 $\mu\text{g}/\text{L}$ in *Ambystoma maculatum*, and 52 $\mu\text{g}/\text{L}$ in *Xenopus laevis*.

This review indicates that UV light decreases the concentrations at which PAH contamination can result in acute toxicity. Photoenhanced PAH toxicity appears to be associated with acute responses and not long-term chronic stress. The increased toxicity is associated with photomodification of PAH compounds and with photosensitization of target tissues. These factors appear to act in an additive manner. It appears that photomodified anthracene is more toxic than other PAH, including fluoranthene and phenanthrene.

In the absence of ameliorative constituents, the threshold for photoenhanced anthracene toxicity appears to be in the range of 1.2 to 4 $\mu\text{g}/\text{L}$. However, the presence of humic substances appears to significantly ameliorate photoenhanced PAH toxicity in addition to absorbing UV in the water column. Humic substances are typically abundant in high organic carbon wetland sediments such as those found in the Des Plaines River wetlands.

PAH Toxicity to Aquatic Plants

The effects of various PAH on aquatic plant growth are highly variable. At low concentrations (10 to 20 ppb), several PAH act as a stimulant to plant growth. At 300 ppb, chrysene was observed by Boney (1974 (in Neff 1979)) to induce a 58% increase in the growth of the red alga, *An-tithamnion plumula*. Other PAH (anthracene and 2-methylanthracene) caused declines of -20% and -12% in the same alga at 300 ppb. In general, PAH concentrations greater than 1,000 ppb inhibit algal growth.

Chronic Toxicity Associated With Dissolved PAH

Neff (1979) addressed chronic stress associated with PAH contamination. He cited Ott and others (1978) and noted that the copepod, *Eurytemora affinis*, suffered statistically

significant reductions in the length of life, total number of nauplii produced, and brood size when exposed to 10 µg/L naphthalene, 2-methylnaphthalene, 2,6-dimethylnaphthalene, or 2,3,5-trimethylnaphthalene for the duration of their lives. Documented instances of chronic stress will be discussed, by effect, in the following paragraphs.

Nearly all PAH are hydrophobic and lipophilic. Thus, there is a potential for these compounds to become associated with stable lipid pools in aquatic organisms. Energy is generally stored as glycogen in bivalves until gametogenesis when the glycogen and lipid stores are converted into eggs and sperm. The eggs contain significant lipid reserves and could become a repository for lipophilic PAH. Moore and others (1989) cited Lowe and Pipe's (1985) observation that long-term exposure to diesel oil at 30 and 130 ppm caused a decrease in the mass of gametes produced by *Mytilus edulis* and *Macoma balthica*.

Mollusks elicit reduced ventilation (feeding) rates at PAH levels as low as 30 to 40 µg/L in seawater (Moore and others 1989). The feeding inhibition probably resulted from the narcotic effect of hydrocarbons, particularly aromatic hydrocarbons. These compounds have a direct effect on cilia, muscles, and/or the nervous system. Reduced feeding rates result in a reduction in scope for growth, a commonly measured parameter that quantitatively describes the energy available for tissue growth, reproduction, and activity. In bivalves, the major problem caused by reduced scope for growth is poor reproductive capacity. While this does not have immediate consequences at the organismal level, the long-term consequences of reduced recruitment could be significant for the population.

Neff (1979) concluded his discussion of PAH-induced chronic toxicity by suggesting that while environmentally realistic dissolved PAH concentrations of 1 to 50 µg/L can cause potentially detrimental, sublethal responses in aquatic organisms, in most cases, the PAH concentrations required to elicit significant sublethal responses are higher than those encountered in all but the most heavily polluted aquatic environments. This statement was strongly supported by the low levels of creosote-derived TPAH (<30 ng/L) observed by Goyette and Brooks (1999) in the immediate vicinity (15 cm) of a major creosote structure in Sooke Basin. The concentration of PAH in the whole tissues of mussels grown within 15 cm of these structures (21.9 ng TPAH/g wet tissue) was not significantly different from that found in mussel tissues from the open control (reference) site (21.7 ng TPAH/g). However, approximately twice as much PAH was sequestered in the gonads of ripe mussels at both sites (44.3 ng/g compared with 21.9 ng/g in whole tissue). Reproductive bioassays on all mussel cohorts grown at varying distances from new and aged creosote-treated piling and untreated Douglas-fir piling did not reveal significant differences. Of all larvae, 65% to 89% developed normally to the "D" hinge stage. The highest percentage of normal larval

development occurred in the cohort grown immediately adjacent to the weathered piling dolphin.

From the preceding discussion on the uptake of PAH from water, food, and sediments, it appears that PAH concentration in the water column (including interstitial water in sediments) is the parameter of greatest significance in defining chronic stress. Furthermore, it appears that sustained water column concentrations of 30 to 50 µg TPAH/L can have subtle but important chronic impacts on populations of marine organisms. However, it appears that dissolved PAH concentrations do not normally reach those levels, except in the case of oil spills or other accidental PAH losses.

Biological Response to Sedimented PAH

The adverse biological response to dissolved PAH is generally inconsequential because these compounds are so hydrophobic and do not readily dissolve in water. This same hydrophobicity causes PAH to bind with dissolved and particulate organic substances, thereby reducing their bioavailability in the water and in sediment. High concentrations of sedimented PAH, with significant biological consequences, are well documented in literature.

Acute and Chronic Toxicity Associated With Sedimented PAH

It has long been recognized that it is the concentration of PAH in sediment interstitial or pore water that correlates with toxicity, not the bulk sediment concentration of PAH. For instance, Tagatz and others (1983) found that the lowest creosote concentration at contaminated sites affecting the abundance or number of taxa was 844 µg creosote per gram dry sediment for mollusks and 177 µg/g for echinoderms, annelids, and arthropods. Similarly, Padma and others (1998) reported that the median lethal concentration for *Mysidopsis bahia* in the water soluble fraction of creosote extracted from sediments was 700 µg/L compared with the significantly lower level of 180 µg/L obtained when the water soluble fraction was added to water without the mediating influence of sediment.

Pastorok and others (1994) reported sediment TPAH concentrations as high as 1,800 µg/g associated with a creosote treating plant at an industrial site in Oregon. They observed significant mortality in *Hyallela azteca* and Microtox (Strategic Diagnostics, Inc., Newark, Delaware) bioassays within 91 m of the plant's pier and shoreline. However, significant increases in neoplastic lesions were not observed in the livers of large-scale suckers (*Catostomus macrocheilus*) and no adverse effects on other demersal species were observed outside the highly contaminated nearshore area. Sediments associated with historical industrial activity and spills in Eagle Harbor (Malins and others 1985), the Elizabeth River (Huggett and others 1992), the Willamette River (Pastorok and others 1994), and Bayou Bonfouca (Catallo and Gambrell 1987) have been contaminated with greater than 49,000 µg/g of creosote-derived PAH. Significant acute

toxicity and changes in microbial, meiofaunal, and macrofaunal communities have been associated with these industrial sites, which have received significant study. The results of some of this research are reviewed in the following paragraphs. Studies describing the biological response to very high levels of sedimented PAH associated with historical industrial activity should not be used to infer environmental response to the use of creosote-treated wood products.

Acute toxicity has not been documented in low to moderate concentrations of sedimented TPAH in open environments (Baekken 1994, Carman and others 1995, Wendt and others 1994, Brooks 2000). However, there is evidence of chronic effects associated with sedimented TPAH at concentrations above perhaps 7 to 10 μg TPAH/g dry sediment. The literature describing these effects is reviewed in the following paragraphs.

Neoplasia Associated With Polycyclic Aromatic Hydrocarbons

Hyperplastic, preneoplastic, and neoplastic lesions have been reported in fish for a number of years. These same types of lesions are far less common in bivalves and other invertebrates.

In vertebrates, enzymes produced by the cytochrome P-450, the mixed-function oxidase (MFO) system, and the aryl hydrocarbon hydroxylase (AHH) system are responsible for initiating catabolism of lipophilic compounds (including PAH). These systems render hydrophobic molecules more water soluble and therefore increase their potential for excretion and detoxification. In the case of certain HMW PAH, the intermediate metabolic products of these enzyme systems can be highly toxic, mutagenic, or carcinogenic. Oxidative metabolism of some PAH (like B[a]P) results in the production of arene oxides, some of which bind covalently to deoxyribonucleic acid (DNA) and ribonucleic acid (RNA) (particularly with guanine). The resulting chromosomal lesions can result in unregulated cell growth and division (cancer).

The ability to metabolize HMW PAH varies significantly between phyla. Among invertebrates, mollusks have low AHH activity and a limited ability to metabolize HMW PAH. Arthropods and annelids show increased activity, and some marine crustaceans have demonstrated significant cytochrome P-450, MFO, and AHH activity.

Vertebrates, including fish, demonstrate high MFO, AHH, and cytochrome P-450 capabilities (Varanasi 1989). The liver is the primary site of MFO activity in fish, and the liver, gut, and gall bladder are primary sites of PAH concentration, metabolism, and excretion. Humans do not normally consume these organs. In Crustaceans, the hepato-pancreas, green gland (excretory organ), pyloric stomach, gills, testes, and eyestalks are major sites of PAH accumulation and AHH enzyme activity. Again, these tissues are not normally

consumed by humans, although, the hepato-pancreas is sometimes eaten as "crab butter."

Melanomacrophage centers are an integral part of the teleost immune system. Payne and Fancey (1989) observed that the numbers of melanomacrophage centers were increased in the livers of fish exposed to TPAH concentrations in the range of 25 to 50 $\mu\text{g}/\text{g}$. These concentrations are found only in heavily polluted harbors, industrially polluted sites, or oil spills. Payne and others (1988) observed changes in MFO enzyme levels and liver fat content in fish exposed to low dissolved hydrocarbon levels of 1,000 $\mu\text{g}/\text{L}$ (perhaps even as low as 200 to 300 μg TPAH/L).

The increased levels of P-450, MFO, and AHH enzymes in fish and crustaceans exposed to high levels of PAH suggest active catabolism of these molecules. Enzyme induction is not a sign of stress, per se. However, there is concern because some of the intermediate products of HMW PAH catabolism are carcinogenic, mutagenic, and teratogenic.

Bioindicator Studies

There is growing interest in enzyme induction and genotoxicity tests as indicators of environmental risk. However, it is important to understand what these tests actually tell us. Effects at the organismal level, associated with external factors, are mediated by numerous levels of protection. Detrimental factors (abnormal temperature, xenobiotics, desiccation, disease organisms, low dissolved oxygen, high levels of pollution, UV radiation, etc.) are often avoided by mobile animals. Sessile animals (including many bivalves) isolate themselves within tightly closed valves in an attempt to avoid harmful conditions.

At the next level of protection, an animal's integument isolates internal organs and structures from harmful conditions. The skin and gut epithelia are capable of selective absorption of material. For instance, HMW PAH, adsorbed to sediments, apparently pass through the digestive tract of many annelids without being absorbed through the gut epithelia.

Once foreign materials are absorbed into the blood serum through the skin, gills, or gut, organisms respond by sequestering them in vacuoles, metabolizing them in the liver, or cleansing them from the serum as it passes through the kidney. Whether or not a molecule is metabolized or excreted depends, in great part, on its ability to penetrate cell membranes. The plasmalemma is highly permeable to essential molecules such as glucose, amino acids, and lipids. These phospholipid bilayers are not very permeable to ions or to large charged polar molecules. The four- to seven-ring HMW PAH are generally not charged, and therefore, they pass across the cell membrane and are actively metabolized by vertebrates.

It is well documented that some metabolic intermediates of HMW PAH, particularly arene oxides, can bind covalently to guanine, producing DNA lesions, which may result in

unregulated cell growth (cancer). These metabolic intermediates are frequently found in the digestive gland (liver or hepatopancreas) where metabolism is most active. The literature contains many citations regarding hepatic lesions (including hepatic carcinomas) in demersal fish associated with PAH-contaminated sediments. However, at Eagle Harbor, the Duwamish River, Elizabeth River, etc., the levels of contamination at which hepatic carcinomas significantly increased were generally greater than 25 to 50 mg/kg. In some areas, Eagle Harbor sediments contained TPAH concentrations as high as 6,000 mg/kg.

Mixed function oxidases, Cytochrome P-450, ethoxy resorfin-O-deethylase, and AHH are important enzyme systems for the metabolism of HMW PAH. There are numerous reports in the literature suggesting that PAH metabolizing enzyme systems are activated at sediment PAH levels as low as 1.0 ppm (Johnson and others 1994).

As previously stated, intermediate PAH metabolites, such as arene oxides can covalently bind to DNA resulting in lesions. However, DNA contains numerous mechanisms that repair miscoded or damaged sequences. This repair is achieved by a suite of enzymes capable of recognizing damaged or mismatched base pairs and excising them. Environmental and/or random damage to DNA is not unusual, and the presence of nicks or double-stranded breaks in nuclear (or ribosomal) DNA does not often lead to unregulated cell growth. Increased DNA damage obviously increases the risk for failure of these repair mechanisms resulting in a number of diseases.

The point is that there are numerous levels of protection involved in maintaining the biological integrity of an organism. In evaluating environmental risks, we must recognize the importance of these cellular safeguards. The questions we ask must recognize that different levels of biological organization will respond differently to the same level of insult. Therefore, our questions must be posed carefully and caution should be exercised when extrapolating biological responses at one level of organization to responses at another level.

Ernst (1994, personal communication) reported the results of genotoxicity tests using subtidal sediments collected at varying distances from a wharf constructed of creosote-treated wood. The PAH were extracted from the sediments, dried, and redissolved in dimethylsulfoxide (DMSO). Trout hepatocytes were exposed to varying concentrations of the PAH preparation, and genotoxicity was assayed using the nick translation assay of Gagne and Blaise (1993) and a modified version of the alkaline precipitation assay described by Olive (1988). The results were quantified by defining a toxicity threshold as the geometric mean of the lowest observed effect concentration and the no observed effects concentration. This test measured the response of DNA in naked digestive gland cells to isolated PAH suspended in a material, which is an exceptionally powerful

solvent for both polar and nonpolar compounds. DMSO is often used as a reaction medium for bimolecular nucleophilic reactions in which the attacking nucleophile (arene oxide) bears a negative charge. Its use in these genotoxicity studies greatly facilitates transfer of PAH across the plasmalemma and of arene oxides into the nucleus. As discussed in Table 30, there are a range of conditions in the genotoxicity testing environment that may lead to an overestimation of toxicity relative to the natural environment.

Payne and others (1988) reported a study supporting the hypothesis that many point sources of hydrocarbon contamination could be harmful to fish health. They found that MFO enzyme levels were altered at hydrocarbon levels as low as 1.0 mg TPAH/kg. The authors noted that PAH levels in this range are encountered in a broad range of aquatic environments, many of which are not associated with pollution. They suggested that hydrocarbons often occur in sufficient concentrations to affect biological responses in fish. They concluded that meaningful bioindicators must distinguish between effects per se and between chronic or acute effects.

Vogelbein and others (1990) described hepatic neoplasms in Mummichogs (*Fundulus heteroclitus*) from a site with high PAH levels (22 mg TPAH/kg) in sediments. Ninety-three percent of the Mummichogs collected at this site had gross hepatic lesions, and 33% of these had hepatocellular carcinomas. Fish from a site of lower contamination (0.063 mg TPAH/kg) did not show signs of hepatic lesions or carcinomas. Similar cellular lesions have been described in fish from a highly urbanized area (the Duwamish River estuary) in Puget Sound (Pierce and others 1977).

Colwell (1986) examined mussels and seawater associated with creosoted marine pilings at the Roosevelt Roads Naval Station Complex in Puerto Rico. She employed *Salmonella typhimurium* in the familiar Ames test (Ames and others 1975) for mutagenicity and found no detectable mutagenic activity in bacteria from either the water or mollusks associated with the creosote. She concluded that the creosote did not exhibit any appreciable leaching into the surrounding water.

Effects of PAH Contamination on Populations of Aquatic Organisms

Mesocosm studies by Stekoll and others (1980) and Widows and others (1982, 1985) reported similar community responses to petroleum and PAH contamination. Significant, long-term reductions in the abundance and diversity of invertebrate fauna were reported when ambient water levels contained as little as 130 µg/L dissolved diesel oil for prolonged periods of time. Less significant population effects were observed on a rocky shore community exposed to 30 µg/L diesel oil for 2 months.

Tagatz and others (1983) examined the impacts of creosote-contaminated sand on macrofaunal communities. They found

Table 30—Comparison of exposure conditions in the genotoxicity testing environment and the natural environment and the potential effects of these environments on toxicity

Genotoxicity test environment	Organismal environment in open aquatic systems
1. PAH are desorbed and extracted from sediments. They are made very available to the test cells.	1. PAH are bound to sediments. They are not readily available in a dissolved and therefore bioavailable phase.
2. No organismal epithelium present	2. After desorption from sediments, PAH must cross an external epithelium (skin, gills, gut) before entering the blood stream for delivery to the digestive gland.
3. No kidney present to clear PAH.	3. Kidney present. It functions to clear some xenobiotics. Fish rapidly excrete most PAH.
4. Plasmalemma compromised by DMSO	4. Cell membrane selectively restricts movement of PAH into the cell. This increases the probability of excretion and decreases the probability of metabolism.
5. Lysosomal membranes compromised by DMSO.	5. Lysosomal membranes help contain intermediate metabolites during metabolism.
6. Nuclear membrane compromised by DMSO	6. Nuclear membrane provides another level of protection for DNA.
7. DNA lesions assumed to result in unregulated cell growth.	7. DNA repair mechanisms reduce the probability of unregulated cell growth.

that the lowest creosote (in sediment) concentration that affected the number of individuals or species was 844 mg TPAH/kg for mollusks and 177 mg TPAH/kg for echinoderms, annelids, and arthropods.

The adaptation of microbial communities in the gut of *Limnoria tripunctata* and in sediment are well documented and discussed in Neff (1979). Similar adaptations were described by Wade and others (1989) in Gulf of Mexico hydrocarbon seep communities including numerous species of annelids, crustaceans, bivalves, and fish. Tissue PAH concentrations indicated that these organisms were chronically exposed to high levels of PAH. The seep organisms were able to survive and thrive in an environment of high PAH exposure. The apparent ability to cope with these elevated levels of PAH may involve specially adapted enzyme systems.

Brooks (2000) examined the loss of PAH and the biological response to creosote-treated bridges crossing Pipe Creek in Indiana. Total organic carbon was low at both bridges studied (0.48% at one bridge (B146) and 0.89% at the other (B148)). Higher sediment concentrations of PAH (0.114 to 5.3 µg TPAH/g dry sediment) were observed under and downstream from 2-year-old B146 than at 17-year-old B148 (0.209 to 2.256 µg TPAH/g). Sediment concentrations of individual or total PAH did not exceed the threshold effects level (TEL; Smith and others 1996) at B148. However, concentrations of naphthalene, acenaphthene, fluorene, phenanthrene, and fluoranthene exceeded the TEL but not the probable effects level (PEL; Smith and others 1996) at the newer B148. Adverse effects were not observed in the robust aquatic community observed in this slow moving, silt- and sand-laden stream flowing through an agricultural land-

scape. Ten-day *Hyalella azteca* laboratory bioassays did not reveal toxicity associated with any of the treatment stations compared with survival in either laboratory control sediments or the upstream reference station. No observed adverse effects were documented in the invertebrate communities associated with either bridge or with the small amount of PAH lost from them.

PAH Toxicity Summary

The LMW PAH such as naphthalene and acenaphthene produce acute toxic effects in marine animals because they are more soluble than the HMW compounds. Acute intoxication in the sensitive larval stages of marine invertebrates may occur at water column concentrations as low as 8 to 10 µg/L. However, for most species, the literature suggests that water column concentrations of greater than 20 µg/L are required for significant responses. The LMW PAH are more soluble than the HMW compounds, and bacteria and other aquatic organisms more rapidly metabolize them. The potential for their accumulation to toxic levels is small except when introduced in large quantities such as occurs in petroleum spills. However, laboratory (including mesocosm) studies have demonstrated photoenhanced toxicity associated with fluoranthene and anthracene at levels as low as 3 µg/L in the water column.

Because of their decreased biological availability, sedimented PAH have a low potential to cause acute pathological responses at either the organismal or population levels in aquatic species. However, sediment levels of creosote exceeding 177 mg/kg have been shown to cause significant impacts on populations of the most sensitive taxa (Tagatz

and others 1983). Furthermore, bacteria and eukaryotes have demonstrated a remarkable ability to adapt to relatively high levels of baseline PAH.

Chronic toxicity is more difficult to measure than acute toxicity. This appendix suggests that chronic stress can occur in organisms, including bivalves, at concentrations as low as 30 to 40 μg TPAH/L. Chronic stress causes reduced scope for growth and reduced reproductive capacity, which can have long-term consequences for populations of aquatic species.

In addition to direct physiological stress, there is a potential for the HMW PAH (particularly B[a]P) to form carcinogenic, mutagenic, and teratogenic compounds during metabolism by crustaceans and vertebrates. Neff (1979) summarized his section on neoplasia by noting that while carcinogenic PAH can produce cancer-like growths and cause teratogenesis and mutagenesis in some aquatic invertebrates and vertebrates, there are no reports of cancer being induced by exposing aquatic animals to environmentally realistic levels of carcinogenic PAH in the water, food, or sediments. However, recent studies describe increases in the number of hepatic lesions and carcinomas with sediment TPAH burdens as low as 7 to 10 mg/kg.

Recommended Numerical Benchmarks for Evaluating Environmental Risks Associated with PAH

Numerous jurisdictions have established benchmarks for evaluating environmental risks associated with PAH in aquatic environments. Washington State (regulation WAC 173-204) published sediment quality standards (SQS) for individual PAH and for the sum of LMW and HMW compounds. In addition, the U.S. EPA has proposed, but not adopted, freshwater criteria for acenaphthene, phenanthrene, and fluoranthene. This appendix does not reveal freshwater sediment quality criteria for individual PAH compounds or their mixtures. There are numerous proposals for maximum allowable levels based on the lowest levels at which adverse effects are observed in a broad spectrum of environments. The broad application of criteria based on the observance of effects in worst-case environments results in very conservative assessments that are not representative of the worst case. In addition, the following discussion assumes that the toxicity of mixtures of PAH is additive. As previously discussed, it appears that toxicity associated with the mixture of PAH called creosote is significantly less than additive, thereby adding to the conservativeness of proposed benchmarks.

Benchmarks for Assessing Risk of Dissolved PAH

The TPAH model in Swartz and others (1995) assigns a <5% probability of mortality greater than 24% for all samples with $\sum\text{TU}_i < 0.186$. Swartz and others (1995) stated that, “The TPAH Threshold of Acute Toxicity

($\sum\text{TU}_i = 0.186$, $p_{>24} = 0.05$) is the toxic-unit concentration below which mixtures of PAH are unlikely to contribute to sediment toxicity and above which PAH mixtures increase $p_{>24}$ over baseline conditions.” Swartz and others (1995) did not distinguish between chronic and acute toxicity in stating that $\sum\text{TU} = 0.186$ is an appropriately protective benchmark. The Swartz and others (1995) model was developed based on equilibrium partitioning to estimate sediment toxicity for infauna. More importantly, Swartz and others (1995) compared the TPAH model with other PAH benchmarks and found that $\sum\text{TU} = 0.186$ was equivalent to both the screening level concentration (SLC) and the National Oceanic and Atmospheric Administration’s (NOAA) effects range-low (ER-L). Both the SLC and ER-L are sediment benchmarks below which adverse effects (including chronic effects) are rarely observed (lower 10th percentile of the effects database). The SLC and ER-L are frequently used as benchmarks to determine if sediments require further investigation. Contaminant levels at or below the ER-L or SLC are not considered biologically stressful and generally require no further evaluation.

Swartz and others (1995) assumed toxicity was additive for the suite of PAH in creosote. However, there is evidence indicating that the PAH in creosote are less than additive in their cumulative toxicity. The California EPA (1994) determined 96-h LC_{50} of 990 $\mu\text{g}/\text{L}$ for bluegill (*Lepomis macrochirus*) and 880 $\mu\text{g}/\text{L}$ for rainbow trout (*Oncorhynchus mykiss*) exposed to whole creosote oil. Assuming that the creosote components were present in the bioassay in proportion to that found in whole creosote oil, these LC_{50} values represent approximately 112 TU. Munoz and Tarazona (1993) noted that “when the sum of individual compounds have to be used, the differences in acute toxicities between individual chemicals (and their cumulative action) could be higher than an order of magnitude.”

Application of a 0.1 factor to convert the 96-h LC_{50} of 880 μg creosote/L for rainbow trout to a chronic value suggests that 11.2 TU would be a defensible benchmark for creosote. However, the 0.186 TU benchmark suggested by Swartz and others (1995) is very conservative for evaluating the risks associated with dissolved PAH. The TU approach was adopted in the preceding report on railway ties because the combined stresses of multiple contaminants may cause environmental effects that would not be expected if the risk of each contaminant were evaluated separately. However, assuming additive toxicity for creosote may be unnecessarily conservative.

Sediment Quality Benchmarks for PAHs in Aquatic Environments

Freshwater and estuarine sediment quality benchmarks are summarized in Table 23. Numerous other screening benchmarks are available, but these are representative. Swartz (1999) provided a concise summary of the types of existing

guidelines and attempted to consolidate various benchmarks into three tiers for which he claimed consensus support. These levels were the TEL (290 µg TPAH/g organic carbon), median effects concentration (MEC) (1,800 µg TPAH/g organic carbon), and the extreme effects concentration (EEC) (10,000 µg TPAH/g organic carbon). Swartz (1999) noted that the TEC (290 µg/g organic carbon) is the easiest benchmark to interpret because adverse effects cannot be anticipated at values less than this. He notes that values exceeding the EEC are always associated with obvious adverse effects. Swartz (1999) counsils that conclusions regarding the ecological effects of sediment contamination, which probably occur somewhere between the TEC and the MEC, should be based on site-specific analysis and weight of evidence derived from the three elements of the sediment quality triad.

None of the benchmarks given in Table 23 are enforceable SQS. They are simply guideposts for evaluating the effects of contaminants in sediments. Washington State (regulation WAC 173-204) developed enforceable SQS. Draft rule amendments to these standards were distributed in June of 1999. The new standards include an increase in the LMW PAH standard from 370 mg/kg organic content (OC) to 593 mg/kg OC and a decrease in the HMW PAH standard from 960 mg/kg OC to 900 mg/kg OC. The sum of these two classes of PAH is proposed to increase from 1,330 mg TPAH/kg OC to 1,493 mg TPAH/kg OC.

Goyette and Brooks (1999) examined the effects of creosote-treated piling in Sooke Basin, British Columbia. The extensive physicochemical and biological database included in-faunal community analysis and in situ and laboratory bioassays using the amphipods *Rhepoxynius abronius* and *Eohaustorius estuarius*, liquid and solid phase Microtox (Strategic Diagnostics, Newark, DE), echinoderm fertilization and *Mytilus edulis edulis* growth, survival, and reproductive tests. Physicochemical analyses included a detailed description of sediment and water column concentrations of alkylated and parental PAH. This database allowed for an examination of the efficacy of existing and proposed SQS in predicting adverse biological response. The U.S. EPA draft sediment quality criteria for acenaphthene (130 µg/g OC), phenanthrene (180 µg/g OC), and fluoranthene (620 µg/g OC) were found to be underprotective in that they failed to predict observed adverse biological effects in three database samples. False negative responses (adverse effects observed but not predicted by the benchmark) were not observed for any of the other benchmarks. Goyette and Brooks (1999) found that 60 individual PAH compounds exceeded the TEL in seven separate sediment samples where no toxicity was observed (TEL described by Jones and others 1997). These false positive indications associated with the TEL were observed for every PAH compound except naphthalene. The Washington State SQS (WAC 173-204) were most efficient in predicting adverse effects (12 false

positive responses), and the PEL resulted in 21 false positive responses. The mean of the TEL and PEL ((TEL + PEL)/2) resulted in 30 false predictions of adverse effects where none were observed. These results suggested that either the mean of the TEL and PEL or the Washington State apparent effects threshold based SQS were both protective and efficient. In contrast, the TEL and the ER-L (Long and others 1998) were not very efficient and were considered overprotective in the Sooke Basin environment.

Several recent studies have suggested that these levels may not be sufficiently protective in marine environments. Johnson and others (1994) and Horness and others (1998) rely on the precept that observance of an enzyme induction response to PAH implies physiological impairment. However, enzyme induction per se does not imply physiological impairment (Brooks 1997a; Payne and others 1988). Payne and others (1988) supported the hypothesis that many point sources of hydrocarbon contamination could be harmful to fish health. They found that MFO enzyme levels were altered at hydrocarbon levels as low as 1.0 ppm. However, the authors noted that PAH levels in this range are encountered across a broad range of aquatic environments, many of which are not associated with pollution. They suggested that hydrocarbons often occur in sufficient concentrations to affect biological responses in fish and concluded that meaningful bioindicators must distinguish between effects per se and between chronic or acute effects. It is important to recall that Johnson and others (1994, p. 304–329) did not find any adverse effects at the population level.

Johnson and others (1994) and Horness and others (1998) also underestimated sediment PAH exposure, at least in Elliott Bay (10 mg TPAH/kg), the Duwamish Waterway (6 mg TPAH/kg), and Eagle Harbor (90 mg TPAH/kg). Eagle Harbor sediments contained PAH concentrations as high as 6,461 mg TPAH/kg (Swartz and others 1989). Washington Department of Ecology (1995) contains sediment concentrations of PAH for a large number of stations in Elliott Bay. Significant areas contain PAH concentrations in the top 4 cm of the sediment column at 111.3 to 593 mg TPAH/kg dry sediment. The Puget Sound Water Quality Authority (PSWQA 1996) indicates sediment TPAH levels at numerous locations in the Duwamish Waterway at greater than 21 mg TPAH/kg. In general, higher contaminant concentrations are found in shallow nearshore areas associated with Seattle's intensely urbanized upland and with numerous waterfront docks and industrial facilities. Concentrations of TPAH decline in the middle and outer reaches of Elliott Bay (PSWQA 1996). Sediments in these Puget Sound industrial areas also contain high levels of polychlorinated biphenyls (PCBs) and metals. Misitano and others (1994) reported much higher concentrations of both HMW and LMW PAH in these areas than reported by Johnson and others (1994) and Horness and others (1998).

Both papers are based on the false assumption that the English sole subjected to histopathological examination was exposed to a single sediment concentration of TPAH. Juvenile English sole (*Pleuronectes vetulus*) are found in shallow water in the intertidal zone where sediment concentrations of all contaminants are highest. As they grow, English sole move into deeper water but tend to seasonally migrate from deep water in the winter to shallow water in the spring. In British Columbia, English sole are known to make extensive migrations of at least 1,100 km (Hart 1973). The point is that English sole in Elliott Bay and the Duwamish Waterway are exposed to a variety of sediment conditions including TPAH concentrations that greatly exceed those reported by Johnson and others (1994) and Horness and others (1998).

Misitano and others (1994) worked in highly contaminated sediments found in Eagle Harbor, Commencement Bay, and Elliott Bay associated with depositional environments. The sediments are fine grained, and except when disturbed by the thrust of large vessels, they remain undisturbed. These characteristics are commonly associated with most, but not all, contaminated sediments. The bioassay protocol used by Misitano and others (1994) contains two elements that make it difficult to compare the results with real world environments.

First, the authors swirled 20 g of sediment and 800 mL of seawater in 1-L glass beakers to begin the bioassays. This probably resuspended the sedimented PAH particles and PAH adsorbed to clay and/or POM, greatly increasing its bioavailability in the water column. The PAH particles and fine-grained particulate inorganic matter (PIM) and POM to which the PAH were probably adsorbed would be the last to settle and would have accumulated on the surface of the well-sorted sediment at the end of 4 h, again unrealistically increasing the exposure of surf smelt larvae to the contaminants.

Second, the authors then placed the beakers under continuous fluorescent light at 3,240 lux. The photoenhanced (UV spectrum) toxicity of anthracene, phenanthrene, fluoranthene, and B[a]P is well known to occur at thresholds of 3 to 12 µg/L (Gala and Giesy 1992, Landrum and others 1992, Ankley and others 1995). Photoenhanced PAH toxicity occurs at a lower PAH concentration than occurs in the dark or at low light levels. Photoenhanced PAH toxicity has been well documented in laboratory bioassays and in microcosm studies but not well documented in natural aquatic systems.

The results of this study are interesting and demonstrate that the observed effects can be associated with larval exposure to a mixture of contaminants in industrial sediments under the conditions imposed (resuspension of contaminated, fine-grained sediments in a small volume of water and photoactivation). Those conditions are not characteristic of very many depositional areas, which more frequently occur in water

deep enough to attenuate incident sunlight and where sediments are infrequently disturbed to the degree implicit in swirling them in 800 mL of water. It is not appropriate to infer that the same response is likely in the real world. The literature suggests that there is a reasonable correlation between concentrations exceeding 700 to 1,000 µg TPAH/g OC and preneoplastic lesions or neoplasia but not at concentrations less than this.

Swartz (1999) examined existing and proposed SQS and proposed consensus guidelines that appear to resolve some of the current inconsistencies. He described a TPAH toxicity threshold that is consistent with the ER-L of Long and others (1995) and a TPAH mixture LC₅₀ that is similar to the effects range median described by the same authors. Table 31 summarizes these benchmarks.

Table 31—Summary of the TPAH toxicity threshold, TPAH mixture lethal concentration (LC₅₀), and the mean of these two values for 17 parental PAH.

PAH compound	TPAH toxicity threshold ^a (µg/g organic carbon)	TPAH mixture LC ₅₀ ^a (µg/g organic carbon)	Mean (µg/g organic carbon)
Naphthalene	13	71	42.0
Acenaphthylene	3	15	9.0
Acenaphthene	4	23	13.5
Fluorene	17	90	48.5
Phenanthrene	29	155	92.0
Anthracene	21	114	67.5
Fluoranthene	69	371	220.0
Pyrene	90	481	285.5
Benz(a)anthracene	21	111	66.0
Chrysene	31	169	100.0
Benzo(b)fluoranthene	33	180	106.5
Benzo(k)fluoranthene	29	155	92.0
Benzo(a)pyrene	33	179	106.0
Low molecular weight PAH	87	468	277.5
High molecular weight PAH	306	1,646	976.0
Total PAH	393	2,114	1,253.5

^aFrom Swartz (1999)