

**Technology Evaluation Report
for the
NoVOCs™ Technology Evaluation
Superfund Innovative Technology Evaluation Program**

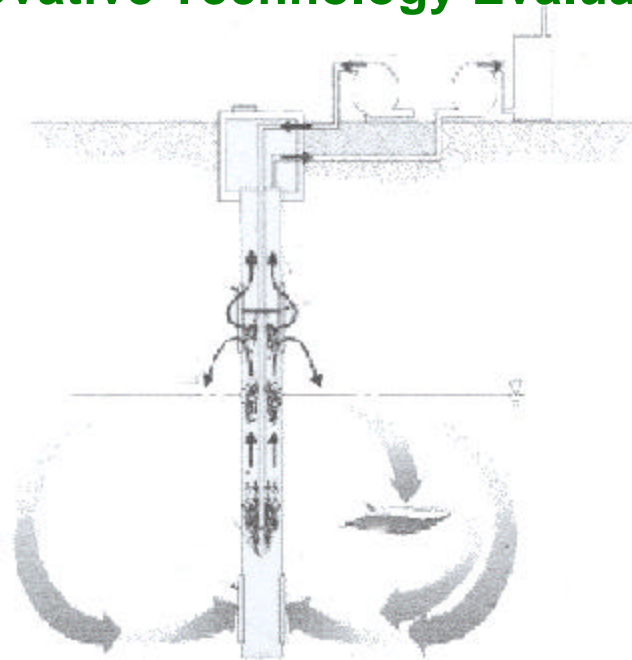

Prepared for:

**U.S. Environmental Protection Agency
Office of Research and Development
National Risk Management Research Laboratory
Cincinnati, Ohio**

Prepared by:



**Tetra Tech EM Inc.
San Diego, California**



**EPA Contract No. 68-C5-0037
Work Assignment No. 0-37**

June 2000

**Volume I: Technology Evaluation Report
Appendix A: Auxillary Tables and Graphs, Appendix B: Vendor Case Studies
Appendix C: Hydrogeological Report**

MACTEC, Inc.

NoVOCs™ Technology

Technology Evaluation Report

National Risk Management Research Laboratory
Office of Research and Development
U.S. Environmental Protection Agency
Cincinnati, OH 45268

Notice

The information in this document has been funded by the U.S. Environmental Protection Agency's (EPA) Superfund Innovative Technology Evaluation (SITE) Program under Contract No. 68-C5-0036, Work Assignment No. 0-37 to Tetra Tech EM Inc. It has been subjected to EPA's peer and administrative reviews and has been approved for publication as an EPA document. Mention of trade names or commercial products does not constitute an endorsement or recommendation for use.

Foreword

The U.S. EPA is charged by Congress with protection the National's land, air, and water resources. Under a mandate of national environmental laws, the Agency strives to formulate and implement actions leading to a compatible balance between human activities and the ability of natural systems to nurture life. To meet this mandate, EPA's research program is providing data and technical support for solving environmental problems today and building a science knowledge base necessary to manage our ecological resources wisely, understand how pollutants affect our health, and prevent or reduce environmental risks in the future.

The National Risk Management Research Laboratory (NRMRL) is the Agency's center for investigation of technological and management approaches for reducing risks from threats to human health and the environment. The focus of the Laboratory's research program is on methods for the prevention and control of pollution to air, land, water and subsurface resources; protection of water quality in public water systems; remediation of contaminated sites and groundwater; and prevention and control of indoor air pollution. The goal of this research effort is to catalyze development and implementation of innovative, cost-effective environmental technologies; develop scientific and engineering information needed by EPA to support regulatory and policy decisions; and provide technical support and information transfer to ensure effective implementation of environmental regulations and strategies.

The Superfund Innovative Technology Evaluation (SITE) Program was authorized by the Superfund Amendments and Reauthorization Act of 1986. The Program, administered by EPA, is intended to accelerate the development and use of innovative cleanup technologies applicable to Superfund and other hazardous waste sites. This purpose is accomplished through technology evaluations designed to provide performance and cost data on selected technologies.

An evaluation of the MACTEC Inc., NoVOCs™ technology was conducted under the SITE Program, in partnership with the Naval Facilities Engineering Command Southwest Division, the Navy Environmental Leadership Program, the EPA Technology Innovation Office, and Clean Sites, Inc. Specifically, the NoVOCs™ technology performance in treating groundwater contaminated with volatile organic compounds (VOC) at Naval Air Station North Island, Installation Restoration Site 9 was evaluated. The results of the evaluation, including information on the performance and cost of the technology, are presented in this Technology Evaluation Report (TER). Because of operational difficulties encountered during the demonstration, a complete evaluation of the performance and cost characteristics of the NoVOCs™ technology's ability to treat VOC-contaminated groundwater could not be conducted. However, valuable information was collected regarding the operation and maintenance of the NoVOCs™ technology and site-specific factors that may influence the performance and cost of the system. This information may be useful to decision-makers when carrying out specific remedial actions using this technology or conducting further technology performance evaluations. Data from the SITE evaluation may require extrapolation for estimating the operating ranges in which the technology will perform satisfactorily. Only limited conclusions can be drawn from the field evaluation documented in this TER.

E. Timothy Oppelt, Director
National Risk Management Research Laboratory

Acknowledgments

This report was prepared under the direction of Michelle Simon, the U.S.EPA Work Assignment Manager. The MACTEC NoVOCs™ technology evaluation was conducted under the EPA Superfund Innovative Technology Evaluation (SITE) Program. This report was prepared for the EPA SITE Program by Tetra Tech EM Inc. The NoVOCs™ technology evaluation was a cooperative effort that involved the following personnel from the EPA National Risk Management Research Laboratory (NRMRL); EPA Technology Innovation Office (TIO); Naval Facilities Engineering Command Southwest Division (SWDIV); Navy Environmental Leadership Program (NELP); Clean Sites, Inc; MACTEC, Inc.: Thermatrix, Inc.; California Department of Toxic Substances Control (DTSC); the Regional Water Quality Control Board, San Diego Region (RWQCB); San Diego Air Pollution Control District (APCD); Bechtel National, Inc.; Gilbert Hill Associates; and Umtanum Enterprises.

Joe Aiken	MACTEC, Inc.
Rafat Abbasi	DTSC Project Manager
Steve Baker	Umtanum Enterprises
Charles Cheng	RWQCB Project Manager
John Clark	Thermatrix, Inc.
Bill Collins	SWDIV Installation Restoration Program Manager
Dave Demars	SWDIV Remedial Project Manager
Scott Donavan	Bechtel National, Inc.
Annette Gatchett	EPA/NRMRL/SITE Program Manager
Eric Jensen	MACTEC, Inc., Subcontractor
Ann Kern	EPA/NRMRL Divisional Quality Assurance Manager
Jim Kozakowski	Bechtel National, Inc.
Fayaz Lakhuala	MACTEC, Inc., Subcontractor
Mike Magee	NELP Program Manager
Mark McGlathery	MACTEC, Inc.
Charles Miller	Gilbert Hill Associates
Debbie Newberry	Clean Sites Project Manager
Rich Rolfe	San Diego APCD
Warren Schultz	MACTEC, Inc.
Michelle Simon	EPA/NRMRL Work Assignment Manager
Gary Turner	EPA/TIO Project Manager
Melinda Trizinsky	Clean Sites Technical Program Manager

EPA would also like to thank the following reviewers:

Marc Gill	Mitreter Systems for James Gonzales of the Air Force Center for Environmental Excellence
Robert Hinchee	Parsons Engineering
Richard Johnson	Oregon Graduate Research Institute

Contents

Volume I

Notice	ii
Foreword	iii
Acknowledgments	iv
Figures	viii
Tables	ix
Acronyms and Abbreviations	xiii
Executive Summary	ES-1
1.0 Introduction	1
1.1 Project Background	5
1.2 The Superfund Innovative Technology Evaluation Program	8
1.3 Technology Description	9
1.4 Key Contacts	14
2.0 Site Description, Objectives, and procedures	16
2.1 Demonstration Site Description	16
2.1.1 Site History	16
2.1.2 Site Topography	17
2.1.3 Regional and Site Geology	17
2.1.3.1 Regional Geology	19
2.1.3.2 Site Geology	19
2.1.4 Site Hydrogeology	20
2.1.5 Soil and Groundwater Contamination	23
2.2 Evaluation Objectives	24
2.3 Evaluation Methods and Procedures	25
2.3.1 Field Equipment Installation	25
2.3.2 Evaluation Design	26
2.3.2.1 Sampling and Analysis program	26
2.3.2.2 Sampling and Measurement Locations	31
2.3.3 Sampling Methods	32
2.3.3.1 Groundwater Samples	32
2.3.3.2 Air Sampling	32
2.3.3.3 Air Flow Measurements	33
2.3.4 Analytical Methods	33
2.3.5 Quality Assurance and Quality Control program	33
2.3.5.1 Field Quality Control Checks	35
2.3.5.2 Laboratory Quality Control Checks	35
2.4 Modifications to the Test Evaluation Plan	36

Contents, Cont.d

3.0	Evaluation Results	38
3.1	Operating Conditions	38
3.1.1	NoVOCs™ and Thermatrix System Configurations	38
3.1.1.1	NoVOCs™ System Configuration	38
3.1.1.2	Thermatrix Flameless Thermal Oxidation System Configuration	45
3.1.2	NoVOCs™ Demonstration Operation Data Narrative	48
3.1.2.1	System Startup and Shakedown 2/26-3/26/98	52
3.1.2.2	Early System Operation 4/20 - 6/19/98	59
3.1.2.3	Aquifer Testing and System Modification 7-9/98	63
3.1.2.4	NoVOCs™ Well Operation after Reconfiguration 9/24-10/31/98	69
3.1.2.5	Final Configuration and Operation 12/4/98 - 1/4/99	69
3.1.3	System Operation and Maintenance	83
3.1.4	Colloidal Borescope	90
3.1.5	Diffusional Multi-layer Sampler	91
3.2	Results	92
3.2.1	Primary Objectives	93
3.2.1.1	Primary Objective P1	93
3.2.1.2	Primary Objective P2	97
3.2.1.3	Primary Objective P3	98
3.2.2	Secondary Objectives	105
3.2.2.1	Secondary Objective S1	107
3.2.2.2	Secondary Objective S2	107
3.2.2.3	Secondary Objective S3	112
3.2.2.4	Secondary Objective S4	114
3.2.2.5	Secondary Objective S5	114
3.2.2.6	Secondary Objective S6	118
3.2.2.7	Secondary Objective S7	119
3.3	Data Quality	120
4.0	Economic Analysis	124
4.1	Basis of Economic Analysis	124
4.1.1	Operating, Maintenance, and Monitoring Factors	125
4.1.2	Site Conditions and System Design Factors	126
4.2	Cost by Category	128
4.2.1	Site Preparation Costs	128
4.2.2	Permitting and Regulatory Requirements Costs	130
4.2.3	Equipment Costs	131
4.2.4	Startup Costs	132
4.2.5	Labor Costs	132
4.2.6	Consumables and Supplies Costs	132
4.2.7	Utilities Costs	133
4.2.8	Effluent Treatment and Disposal Costs	133
4.2.9	Residuals and Waste Shipping and Handling Costs	134
4.2.10	Analytical Services Costs	135
4.2.11	Maintenance and Modification Costs	136
4.2.12	Demobilization Costs	136

Contents, Cont.

4.3	Cost Summary	137
5.0	Conclusions	138
6.0	Technology Status and Case Studies	146
7.0	References	149

Appendix A. Auxiliary Tables and Graphs
Appendix B. Vendor Case Studies
Appendix C. Hydrogeologic Investigation Results

Volume II

Appendix D, Part 1: Laboratory Data - First Baseline Sampling Event

Volume III

Appendix D, Part 2: Laboratory Data - First Baseline Sampling Event (continued)

Volume IV

Appendix D, Part 3: Laboratory Data - First Through Fourth Weekly Sampling Events

Volume V

Appendix D, Part 4: Laboratory Data - First Monthly and Second Baseline Sampling Events

Volume VI

Appendix E: Field Data
Appendix F: Quality Assurance and Quality Control Data Summary

Figures

1.	Vicinity map	2
2.	Naval Air Station North Island and Site 9 location map	3
3.	SITE 9 chemical waste disposal areas	4
4.	NoVOCs™ system	10
5.	Well locations	12
6.	Generalized cross-section	13
7.	SITE 9 topographic elevations	18
8.	Geologic cross-section location	21
9.	Geologic cross-section A-A'	22
10a.	NoVOCs™ as-built diagram	39
10b.	Wellhead as-built diagram	41
10c.	Reconfigured wellhead as-built diagram	42
11a.	Wellhead area photograph	46
11b.	Wellhead photograph	46
11c.	Service equipment photograph	46
11d.	Control trailer photograph	46
12.	Thermatrix flameless oxidation system	47
13a.	NoVOCs™ System blower run time - sheet 1	49
13b.	NoVOCs™ System blower run time - sheet 2	50
13c.	NoVOCs™ System blower run time - sheet 3	51
14.	NoVOCs™ System pressure and flow measurement - 2/26/98	53
15.	NoVOCs™ System well pumping rate versus air to water ratio - 3/16/98	55
16.	Groundwater air sparging pH results	56
17.	Titration test results	57
18.	NoVOCs™ System pH cycles - 3/13 and 3/17/98	58
19a.	NoVOCs™ well internals photograph	60
19b.	NoVOCs™ well air unit photograph	60
19c.	NoVOCs™ well educator pipe photograph	60
19d.	Biofouling sample photograph	60
20.	Water level in the NoVOCs™ well - 5/13/98	61
21.	NoVOCs™ well recharge test results	65
22.	Orifice plate flow sensor calibration curve	67
23.	Iron precipitation test results	70
24.	NoVOCs™ well recharge test - 12/2/98	72
25a.	NoVOCs™ well recharge piezometer water level - 12/4-5/98	74
25b.	NoVOCs™ well recharge piezometer water level - 12/6-7/98	75
25c.	NoVOCs™ well recharge piezometer water level - 12/6-7/98	76
25d.	NoVOCs™ well recharge piezometer water level - 12/7-8/98	77
26.	NoVOCs™ well pumping rate - 12/31/98 - 1/4/99	80
27.	Simplified iron stability diagram	86
28.	Total volatile organic compound mass removed best fit trend line	104
29.	Total volatile organic compound mass removed during system operation	106

Tables

1.	Well screen intervals	27
2.	Sampling and analysis summary	28
3.	Analytical methods	34
4.	NoVOCs™ system operating parameters - 12/10/98	78
5.	Results of field analyses - 12/30/98	83
6.	Treatment system removal summary	94
7.	Air sample results - NoVOCs™ influent sampling port A1	100
8.	Air sample results - NoVOCs™ effluent sampling port A2	101
9.	Summary of total volatile organic compound mass removed	103
10.	1,1-dichloroethene concentration summary	108
11.	CIS - 1,2-dichloroethene concentration summary	109
12.	Trichloroethene concentration summary	110
13.	Summary of operating parameters	113
14.	Air sample results - Thermatrix influent sampling port A3	115
15.	Air sample results - Thermatrix effluent sampling port A4	116
16.	Data quality outliers	121
17.	Costs associated with the NoVOCs™ system	129
18.	Costs associated with the Thermatrix system	135

Acronyms and Abbreviations

APCD	Air Pollution Control District
APHA	American Public Health Association
ARAR	Applicable or Relevant and Appropriate Requirements
ASTM	American Society for Testing and Materials
ATTIC	Alternative Treatment Technologies Information Center
Bechtel	Bechtel National, Inc.
bgs	Below ground surface
BTEX	Benzene, toluene, ethylbenzene, and xylenes
CERI	Center for Environmental Research Information
cm/sec	Centimeters per second
CPT	Cone penetrometer test
DCA	Dichloroethane
DCE	Dichloroethene
DNAPL	Dense nonaqueous-phase liquid
EG&GE	EG&G Environmental
Eh	Reduction/oxidation potential
EPA	U. S. Environmental Protection Agency
EF	Degree Fahrenheit
ft/day	Feet per day
ft/ft	Feet per foot
ft ² /day	Square feet per day
gpm	Gallons per minute
gpm/ft	Gallons per minute per foot
g/cm ³	Grams per cubic centimeter
HCl	Hydrochloric acid
HP	Horsepower
IR	Installation Restoration
kWh	Kilowatt hour
kW/HP	Kilowatt per horsepower
MACTEC	MACTEC, Inc.
MCAWW	Method for the Chemical Analysis of Water and Wastes
MCL	Maximum contaminant levels
mg/kg	Milligrams per kilogram
mg/L	Milligrams per liter
MLLW	Mean lower low water
MS	Matrix spike
MSD	Matrix spike duplicate
mv	Millivolts
NA	Not analyzed
NC	Not calculated
NAS	Naval Air Station
NELP	Navy Environmental Leadership Program
NOAA	National Oceanic and Atmospheric Administration
NTU	Nephelometric turbidity units

Acronyms and Abbreviations Cont.

NRMRL	National Risk Management Research Laboratory
NTIS	National Technical Information Service
ORD	Office of Research and Development
OSWER	Office of Solid Waste and Emergency Response
PAH	Polynuclear aromatic hydrocarbon
PCE	Tetrachloroethene
ppb v/v	Parts per billion on a volume per volume basis
PPE	Personal protective equipment
ppm	Parts per million
psi	Pounds per square inch
PVC	Polyvinyl chloride
QA/QC	Quality assurance/quality control
QAPP	Quality assurance project plan
RCRA	Resource Conservation and Recovery Act
RPD	Relative percent difference
RTU	Remote telemetry unit
RWQCB	Regional Water Quality Control Board
SARA	Superfund Amendments and Reauthorization Act
SRB	Sulfur reducing bacteria
scfm	Standard cubic feet per minute
SITE	Superfund Innovative Technology Evaluation
SVOC	Semivolatile organic compound
SWDIV	Naval Facilities Engineering Command Southwest Division
SW-846	U.S. EPA Test Methods for Evaluating Solid Wastes
1,1,1-TCA	1,1,1-Trichloroethane
TCE	Trichloroethene
TDS	Total dissolved solids
TEP	Test evaluation plan
TER	Technology evaluation report
Tetra Tech	Tetra Tech EM Inc.
Thermatrix	Thermatrix, Inc.
TIO	Technology Innovation Office
VOC	Volatile organic compound
UCL	Upper confidence limit
VISITT	Vendor Information System for Innovative Treatment Technologies
WC	Water column
µg/L	Micrograms per liter
µmhos/cm	Micromhos per centimeter

EXECUTIVE SUMMARY

This Technology Evaluation Report (TER) summarizes the findings of an evaluation of the MACTEC, Inc. (MACTEC), NoVOCs™ in-well volatile organic compound (VOC) stripping system by the U.S. Environmental Protection Agency (EPA), National Risk Management Research Laboratory, Superfund Innovative Technology Evaluation (SITE) Program. The report also includes performance data on the Thermatrix, Inc. (Thermatrix), flameless oxidation system, which was used to treat offgas from the NoVOCs™ system. The NoVOCs™ system was demonstrated at Installation Restoration Site 9 at the Naval Air Station (NAS) North Island in San Diego, California, and was evaluated over an 11-month period from February 1998 to January 1999. The evaluation focused on the ability of the NoVOCs™ system to treat groundwater contaminated with VOCs, specifically, tetrachloroethene, trichloroethene (TCE), dichloroethene (DCE), vinyl chloride, benzene, toluene, ethylbenzene, and xylene.

The demonstration was conducted in partnership with Naval Facilities Engineering Command Southwest Division (SWDIV), Navy Environmental Leadership Program, the EPA Technology Innovation Office, and Clean Sites, Inc. Both the NoVOCs™ and Thermatrix systems were operated and monitored by SWDIV's support contractor, Bechtel National, Inc. (Bechtel). This report summarizes data collected by all involved parties and includes a comprehensive description of the demonstration at NAS North Island and its results.

The NoVOCs™ system did not function without operational difficulties in the highly saline aquifer containing groundwater with total dissolved solids ranging from 18,000 to 41,000 mg/L, which represents an extreme geochemical environment. Because of operational difficulties encountered during the demonstration, a complete evaluation of the performance and cost characteristics of the NoVOCs™ technology could not be conducted. However, valuable information was collected regarding the operation and maintenance of the NoVOCs™ technology and site-specific factors that may influence the performance and cost of the system. This information may be useful to other decision-makers when carrying out specific remedial actions using this technology or conducting further technology performance evaluations. Data from the SITE evaluation may require extrapolation for estimating the operating ranges in which the technology will perform satisfactorily. Since the demonstration was stopped due to operational difficulties, only limited conclusions can be drawn from the field evaluation documented in this TER.

NoVOCs™ Technology Description

MACTEC's NoVOCs™ system is a patented in-well stripping process for in situ removal of VOCs from groundwater. In this process, air injected into a specially designed well simultaneously lifts groundwater, strips VOCs from the groundwater, and allows the groundwater to infiltrate into the aquifer. The NoVOCs™ system installed at NAS North Island consists of a well casing installed into the contaminated saturated zone, with two screened intervals below the water table, and an air injection line extending into the groundwater within the well. This NoVOCs™ well configuration is atypical; the recharge zone of most NoVOCs™ wells is located in the vadose zone. Contaminated groundwater enters the well through the lower screen and is pumped upward within the well by pressurized air supplied through the air injection line, creating an airlift pump effect. As the water is air-lifted within the well, dissolved VOCs in the water volatilize into the air space at the air-water interface. The treated water rises to a deflector plate and is forced out of the upper screen. The treated water is then recharged to the aquifer, and the stripped VOC vapors are removed by a vacuum applied to the upper well casing. At NAS North Island, the stripped vapors were then treated by the Thermatrix flameless oxidation process. Other offgas treatment systems can be used with the NoVOCs™ technology, and the Thermatrix system is not an integral part of the NoVOCs™ treatment system. The equipment used to operate the NoVOCs™ system, including blowers, control panel, and air temperature, pressure, and flow rate gauges, is housed in an on-site control trailer.

Evaluation Objectives and Approach

The SITE evaluation of the NoVOCs™ technology was designed with three primary and seven secondary objectives to provide potential users of the technology with the information necessary to assess the performance of the NoVOCs™ system. The following primary and secondary objectives were selected to evaluate the technologies:

Primary Objectives:

- P1** Evaluate the removal efficiency of the NoVOCs™ well system for VOCs in groundwater.
- P2** Determine the radial extent of the NoVOCs™ treatment cell.

- P3** Quantify the average monthly total VOC mass removed from groundwater treated by the system for 6 months.

Secondary Objectives:

- S1** Quantify the changes in VOC concentrations in the groundwater within the NoVOCs™ treatment cell.
- S2** Document changes in selected geochemical parameters that may be affected by the NoVOCs™ system.
- S3** Document NoVOCs™ system operating parameters.
- S4** Document pre- and post-treatment VOC concentrations and system operating parameters in the Thermatrix flameless oxidation offgas treatment system.
- S5** Document the hydrogeologic characteristics at the treatment site.
- S6** Document the changes in pressure head in the aquifer caused by the NoVOCs™ system.
- S7** Estimate the capital and operating costs of constructing the NoVOCs™ system and Thermatrix flameless oxidation process and maintaining them for 6 months.

Because of operational difficulties with the NoVOCs™ system during the evaluation, not all objectives could be fully evaluated. Specifically, primary objectives P2 and P3 could not be fully evaluated. In these cases, results and conclusions are presented based on the available data.

The primary and secondary objectives were evaluated by collecting weekly and monthly samples from the groundwater and system offgas, as well as conducting a series of aquifer hydraulic tests. Samples were collected and analyzed using the methods and procedures presented in the Technology Evaluation Plan/Quality Assurance Project Plan for the MACTEC NoVOCs™ Technology Evaluation at NAS North Island (Tetra Tech 1998).

During the evaluation, groundwater samples were collected from the NoVOCs™ system influent and effluent using two piezometers installed adjacent to the NoVOCs™ well and from 10 groundwater monitoring wells installed upgradient, crossgradient, and downgradient of the NoVOCs™ well. The groundwater monitoring wells were installed at different depths and radii from the NoVOCs™ well to evaluate changes in contaminant concentrations within the aquifer associated with operation of the

NoVOCs™ system. Air samples were also collected from four sampling locations to evaluate the concentration of contaminants in the influent and effluent of both the NoVOCs™ and Thermatrix systems.

Operation and Maintenance

Operation and maintenance of the NoVOCs™ system was conducted primarily by Bechtel with technical guidance from MACTEC. The NoVOCs™ system was designed to operate continuously, 24 hours a day, 7 days a week. However, during the demonstration, the system experienced significant operational difficulties and was limited to four main operating periods: System Startup and Shakedown (February 26 through March 26, 1998), Early System Operation (April 20 through June 19, 1998), Reconfiguration Operation (September 24 through October 30, 1998), and Final Configuration Operation (December 4, 1998 through January 4, 1999).

Beginning in early May 1998, the NoVOCs™ system began experiencing operating problems associated with high water levels in the NoVOCs™ well and lower-than-designed pumping rates. Initially, it was thought that the flow sensor was not accurately measuring the pumping rate. However, as system operation progressed, the continued low pumping rate and increased frequency of the high water level in the NoVOCs™ well suggested that a more significant problem was occurring. By June 1998, the pumping rate had been reduced from the design rate of 25 gallons per minute (gpm) to about 5 gpm. Based on discussions between the Navy and MACTEC, the system was shut down on June 19, 1998, to evaluate the cause of the poor performance. Suspected causes for the poor performance included (1) biofouling or scaling of the screen intervals and formation near the NoVOCs™ well, (2) possible differences in hydraulic characteristic between the upper and lower portions of the aquifer, and (3) design problems with the NoVOCs™ well, in particular, the length of the recharge screen.

To evaluate the recharge capacity of the NoVOCs™ system and provide information on the hydraulic characteristics of the aquifer in the vicinity of the NoVOCs™ system, a down-well video tape survey and a series of aquifer hydraulic tests were conducted. Based on the aquifer testing, it was concluded that the length of the screened intervals of the NoVOCs™ well should be able to sustain the design pumping rate of 25 gpm. However, during the video tape survey, fouling of the NoVOCs™ well screens by microbiological growth and iron precipitation was observed, which appeared to have impaired the

performance of the NoVOCs™ system by obstructing the well screen and filter pack. Attempts to control fouling by addition of various acids, dispersants, and biocides were unsuccessful, and failure to control the fouling eventually caused termination of the demonstration in January 1999.

Based on the results of the SITE evaluation at NAS North Island and other recirculating well evaluations, well fouling is a recognized problem that requires an appropriate design, as well as monitoring, operation, and maintenance for successful management. Groundwater wells, including in-well stripping systems and recirculating wells, such as the NoVOCs™ system, are subject to fouling from a variety of common causes. The three most common causes of fouling in recirculating wells and groundwater wells in general are (1) accumulation of silt in the well structure, (2) biofouling by colonizing microorganisms, and (3) formation of chemical precipitates or insoluble mineral species. These issues can sometimes be controlled through appropriate design and construction of filter pack and well screens, groundwater pH control to manage formation of chemical precipitates and insoluble mineral species, and injection of a suitable biocide to prevent biofouling. However, any design that does not provide geochemical controls based on site-specific hydrogeologic and geochemical conditions is likely to experience significant operation and maintenance problems due to fouling.

Evaluation Conclusions

Because of operational difficulties with the NoVOCs™ system throughout the demonstration, only limited data were collected to evaluate the technology. Based on the results of the limited data collected during the SITE evaluation, the following conclusions may be drawn about the applicability of the NoVOCs™ technology:

- P1** Comparison of VOC results for groundwater samples taken adjacent to the influent and effluent of the NoVOCs™ system indicated that 1,1-DCE, cis-1,2-DCE, and TCE concentrations were reduced by greater than 98, 95, and 93 percent, respectively, in all the events, except the first sampling event, which was conducted during system shakedown activities. Excluding the first sampling event, the mean concentration of 1,1-DCE, cis-1,2-DCE, and TCE in the water discharged from the NoVOCs™ system was about 27, 1,400, and 32 micrograms per liter (Fg/L), respectively. The 95 percent upper confidence limits of the means for 1,1-DCE, cis-1,2-DCE, and TCE in the treated groundwater were calculated to be about 37, 1,760, and 46 Fg/L, respectively. The maximum contaminant levels (MCL) for these compounds in groundwater are 6 Fg/L for 1,1-DCE, 6 Fg/L for cis-1,2-DCE, and 5 Fg/L for TCE. MACTEC claims that the NoVOCs™ system can reduce effluent VOC concentrations to below MCLs if the contaminant source has been removed. Since dense nonaqueous-phase liquids may be present in the aquifer at

the site and may act as a continuing source of groundwater contamination, MACTEC did not make any claims for reduction of VOC concentrations in groundwater at Site 9.

P2 Because of the sporadic operation of the NoVOCs™ system, a direct evaluation of the radial extent of the NoVOCs™ treatment cell was not conducted. In lieu of direct evaluation method, aquifer hydraulic tests conducted to assess the hydrogeologic characteristics of the site were used to indirectly evaluate the potential radial extent of the NoVOCs™ treatment cell. Although the aquifer pump tests cannot be directly applied to evaluate the radial extent of the NoVOCs™ treatment cell or even that groundwater recirculation was established, the test data does provide information on the radius of influence of the well under pumping (2-dimensional) and dipole (3-dimensional) flow conditions. The resulting changes in pressure head provide an indication of the potential for flow in the surrounding aquifer and are used to provide an estimate of the radial extent of influence created by the NoVOCs™ well. However, the pressure head changes do not accurately represent flow patterns or contaminant transport. Consequently no firm conclusions can be drawn about the radial extent of the NoVOCs™ treatment cell.

During the constant discharge rate (discharge = 20 gpm) pumping test, measurable drawdowns were observed at about 100 feet from the NoVOCs™ well in all directions and different depths. This information indicates that the radius of influence by extraction, specifically at 20 gpm, could be as large as 100 feet. The dipole flow test data shows that measurable pressure responses occur at crossgradient locations 30 feet from the NoVOCs™ well and may be observed at farther distances. However, no drawdowns or water level rises could be positively measured in monitoring wells beyond the 30-foot distance.

P3 Because of operational problems with the NoVOCs™ system, the mass of VOCs removed by the NoVOCs™ system was evaluated during a limited period of operation from April 28 to June 8, 1998. During this period, the average total VOC mass removed by the NoVOCs™ system ranged from 0.01 to 0.14 pounds per hour (lb/hr) and averaged 0.10 lb/hr during the five sampling events. Accounting for the sporadic operation of the NoVOCs™ system, the mass of total VOCs removed during the entire operation period from April 20 through June 19, 1998, was estimated to be about 90 pounds.

S1 VOC concentrations appear to be stratified in the aquifer. In general, the highest concentrations of the three primary VOCs, 1,1-DCE, cis-1,2-DCE, and TCE, were detected in the deep monitoring wells. This trend was especially pronounced for cis-1,2-DCE, which was detected at concentrations between 440 and 96,000 Fg/L in the deep wells, but only between 120 and 1,200 Fg/L in the shallow wells. The intermediate wells generally had the lowest concentration of all three primary VOCs. Because of the limited amount of data collected and operational problems with the NoVOCs™ system throughout the demonstration, trends in the VOC concentration data associated with operation of the NoVOCs™ system were not apparent.

S2 Groundwater samples were collected and analyzed for dissolved metals, alkalinity, total organic carbon, and dissolved organic carbon to evaluate changes in the selected geochemical parameters caused by the NoVOCs™ system. Despite the possible iron fouling problems experienced in the NoVOCs™ well, the groundwater analytical results for dissolved metals exhibited no clear

trends in the data that would suggest that precipitation of dissolved metals was occurring in the aquifer. Based on a review of the data, alkalinity, total organic carbon, and dissolved organic carbon results remained relatively unchanged during the demonstration. Total dissolved solid concentrations showed an increasing trend with depth; however, concentrations did not appear to be affected by operation of the NoVOCs™ system. Conductivity and salinity values measured in the field also increased with depth and appeared to correlate with the analytical results for total dissolved solids. No clear trends were apparent from the field measurements of temperature, pH, and dissolved oxygen, and insufficient data were collected to adequately evaluate trends associated with oxidation/reduction potential.

- S3** During the four operational periods, Bechtel measured the NoVOCs™ system operating parameters, including air temperature, pressure, flow rate, water pumping rate, and pH in the groundwater effluent. The average air temperature at the well intake during the four operational periods ranged from 132 to 152 °F; the pressure ranged from 2.2 to 3.3 pounds per square inch; and air flow ranged from 52.4 to 69.0 standard cubic feet per minute. The water pumping rate within the NoVOCs™ well varied throughout the demonstration; however, based on data provided by SWDIV, the pumping rate ranged from 8 to 34 gpm. Additionally, the average pH in the groundwater effluent during the four operational periods ranged from 3.60 to 7.28.
- S4** Based on a comparison of influent and effluent air samples collected from the Thermatrix system, total VOC concentrations in the 1-hour composite samples collected from the influent ranged from 22,120 to 59,200 parts per billion (ppb) on a volume per volume (v/v) basis and averaged 45,200 ppb v/v during the five sampling events. Total VOC concentrations in the 1-hour composite samples collected from the effluent air sample port ranged from 2.8 to 7.2 ppb v/v and averaged 4.8 ppb v/v during the five sampling events. Total VOC concentrations measured in the Thermatrix influent air sample port were reduced by greater than 99.9 percent in all five sampling events.
- S5** Based on the results of the hydrogeologic investigation conducted at the treatment site, the following hydrogeologic characteristics were estimated:
- Groundwater generally flows to the west or northwest in both of the upper and lower aquifer zones. The horizontal hydraulic gradient in both aquifer zones is relatively flat, ranging from 0.005 to 0.01. Groundwater direction and velocity measurements collected from the monitoring well near the shoreline of the San Diego Bay, using the Colloidal Borescope, indicate that groundwater flows in a west-southwest direction at an average of velocity of 5 feet per day (ft/day).
 - The average hydraulic conductivity is 29 ft/day or 0.01 centimeters per second. The average aquifer storativity and specific yield are 0.004 and 0.07, respectively. The average ratio of horizontal to vertical hydraulic conductivity is 5.7.
 - The calculated average specific capacities are 1.48 gallons per minute per foot (gpm/ft) for the upper screened interval during extraction, 1.50 gpm/ft for the upper screened interval during injection, and 3.22 gpm/ft for the lower screened interval during extraction. The calculated average well efficiencies are 82 percent for the upper screened interval during

extraction, 97 percent for the upper screened interval during injection, and 91 percent for the lower screened interval during extraction.

- The radius of pressure influence (+/- 0.01 feet) during the constant discharge pumping test (20 gpm) is at least 100 feet, based on the drawdown measured at the observation wells.
- The maximum flow of clean tap water that can be injected through the upper screen of the NoVOCs™ well is 25 gpm.
- The aquifer hydraulic conditions do not limit application of the NoVOCs™ technology. The NoVOCs™ well as designed should be able to extract and inject a flow rate of 20 gpm, based on the estimated aquifer hydraulic characteristics.

S6 Pressure head changes in the aquifer caused by the NoVOCs™ system were measured in the groundwater monitoring wells in the vicinity of the NoVOCs™ system during a tidal study conducted at the treatment site before and during operation of the NoVOCs™ system. Groundwater level changes caused by startup and shutdown of the NoVOCs™ system were evident in the water level data for well cluster MW-45, MW-46, and MW-47, located about 30 feet from the NoVOCs™ well. The water level data for observation wells MW-45 (the upper screened well in this cluster) and MW-46 (the intermediate screened well) showed water level increases after system startup. The groundwater elevation increase in well MW-45 was approximately 0.15 feet. Observation well MW-46, the intermediate-depth well, showed a water level increase of approximately 0.05 feet. Observation well MW-47, the deep screened well, showed a water level decrease of approximately 0.025 feet. This pattern of water level increases and decreases associated with the operation of the NoVOCs™ system was expected, based on monitoring well screen locations relative to NoVOCs™ well screen locations. The deep screened well experienced a drop in water level as water was drawn toward the NoVOCs™ well intake, and the upper screened wells experienced increases in water level as water was lifted inside of the NoVOCs™ well and discharged into the upper aquifer zone. In well pair MW-48 and MW-49 (located about 62 feet from the NoVOCs™ well) and in wells MW-50 and MW-51 (located about 91 and 105 feet, respectively, from the NoVOCs™ well), water level changes associated with NoVOCs™ system operation were not apparent.

S7 An economic analysis of using the NoVOCs™ and Thermatrix technologies to treat VOC-contaminated groundwater and offgas was conducted. Based on the SITE evaluation and cost information provided by the Navy and MACTEC, one-time capital costs for a NoVOCs™ system were estimated to be \$190,000; annual operation and maintenance costs were estimated to be \$160,000 per year for the first year and \$150,000 per year thereafter. Because of the time required to remediate an aquifer is site-specific, costs have been estimated for operation of a NoVOCs™ system over a range of time for comparison purposes. Based on these estimates, the total cost for operating a single NoVOCs™ system was calculated to be \$350,000 for 1 year; \$670,000 for 3 years; \$1,000,000 for 5 years; and \$2,000,000 for 10 years. These estimates include an annual inflation rate of 4 percent.

Costs for implementing a NoVOCs™ system at another site may vary substantially from this estimate for the SITE evaluation. A number of factors affect the cost of treatment using the

NoVOCs™ system, including soil type, contaminant type and concentration, depth to groundwater, site geology and hydrogeology, groundwater geochemistry, site size and accessibility, required support facilities and available utilities, type of offgas treatment unit used, and treatment goals. It is important to (1) characterize the site thoroughly before implementing this technology to ensure that treatment is focused on contaminated areas and (2) determine the circulation cell radius for the well and the resulting number of wells needed to remediate a particular site.

The cost of treatment per unit volume of water was not calculated because of the number of assumptions required to make such a calculation and the limited duration of system operation. Because of the site-specific nature of treatment costs, costs per unit volume of water will vary greatly from project to project.

Based on cost information provided by SWDIV, the total cost of the Thermatrix system during the NoVOCs™ demonstration was about \$989,000. This cost includes system acquisition, installation, operation, maintenance, monitoring, and source testing.

1.0 INTRODUCTION

This Technology Evaluation Report (TER) documents and summarizes the findings of an evaluation of the MACTEC, Inc. (MACTEC), NoVOCs™ in-well volatile organic compound (VOC) stripping system conducted by the U.S. Environmental Protection Agency (EPA), National Risk Management Research Laboratory (NRMRL) under the Superfund Innovative Technology Evaluation (SITE) Program. The report also includes performance data on the Thermatrix, Inc. (Thermatrix), flameless oxidation system, which was used to treat offgas from the NoVOCs™ system. The demonstration of the NoVOCs™ system was conducted at Installation Restoration (IR) Site 9 at the Naval Air Station (NAS) North Island in San Diego, California (see Figures 1, 2, and 3) to evaluate the technology's ability to treat VOC-contaminated groundwater. In addition to MACTEC and Thermatrix, the NoVOCs™ demonstration was conducted in partnership with the EPA Technology Innovation Office (TIO), Naval Facilities Engineering Command Southwest Division (SWDIV), Navy Environmental Leadership Program, and the innovative technology public-private partnership program facilitated by Clean Sites, Inc. (Clean Sites). Demonstration data collected by SWDIV and the vendor are included in this report.

Installation and operation of the NoVOCs™ system during the demonstration was conducted by SWDIV's support contractor, Bechtel National, Inc. (Bechtel). Tetra Tech EM Inc. (Tetra Tech) was the SITE Program contractor for the evaluation. This report documents the activities conducted during the demonstration and summarizes data collected by all involved parties.

This TER provides information on the ability of the NoVOCs™ technology to treat groundwater contaminated with VOCs and includes a comprehensive description of the demonstration at NAS North Island and its results. Because of operational difficulties encountered during the demonstration, a thorough evaluation of the performance and cost characteristics of the NoVOCs™ technology's ability to treat VOC-contaminated groundwater could not be conducted. However, valuable information was collected regarding the operation and maintenance of the NoVOCs™ technology and site-specific factors that may influence system performance. This information may be useful to other decision-makers for consideration when carrying out specific remedial actions using this technology or conducting further technology performance evaluations. Data from the demonstration may require extrapolation for estimating the operating ranges in which the technology will perform satisfactorily. Only limited conclusions can be drawn from this field demonstration.

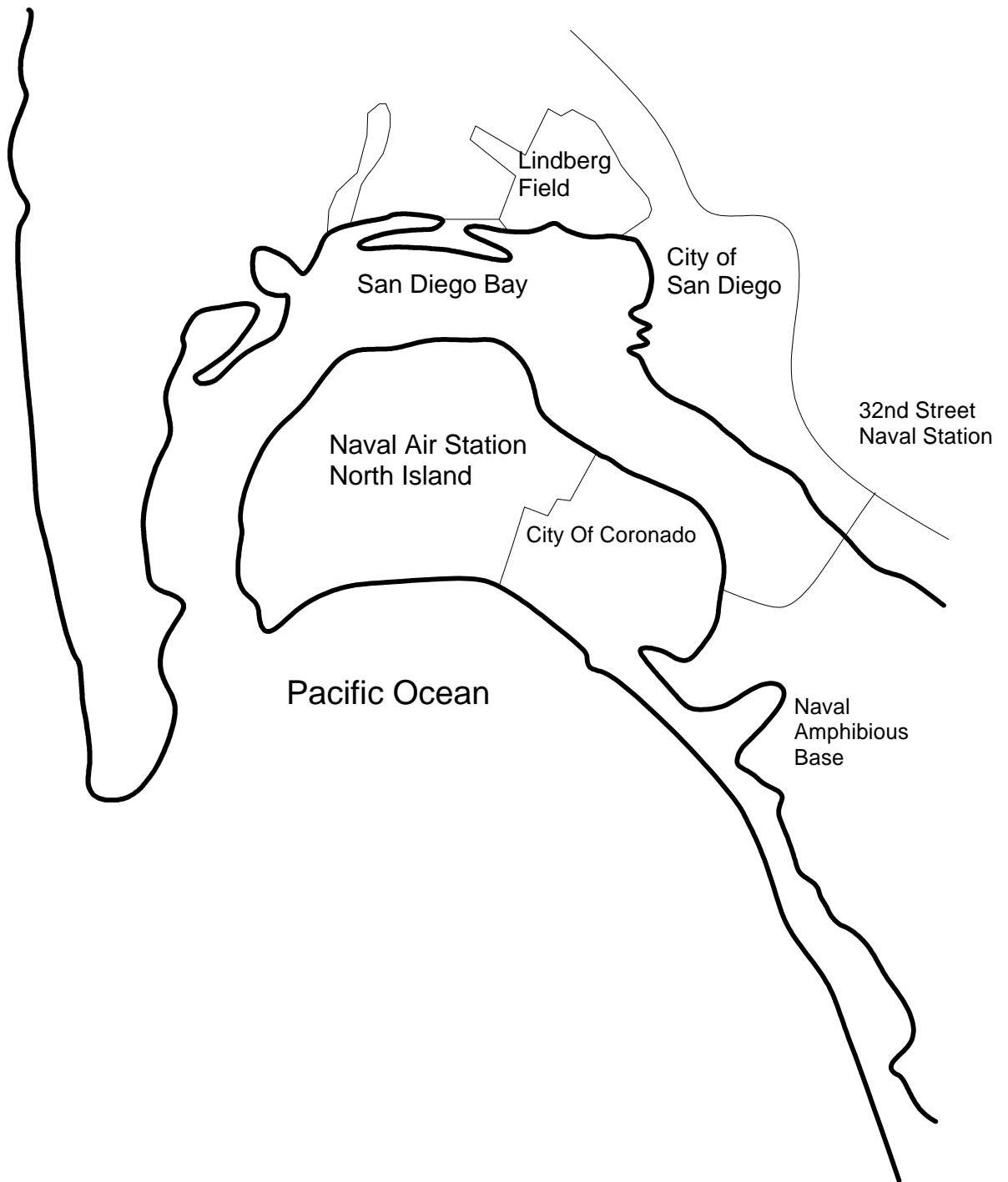

NoVOCs™ SITE Demonstration
Site 9, NAS North Island, California

FIGURE 1
VICINITY MAP

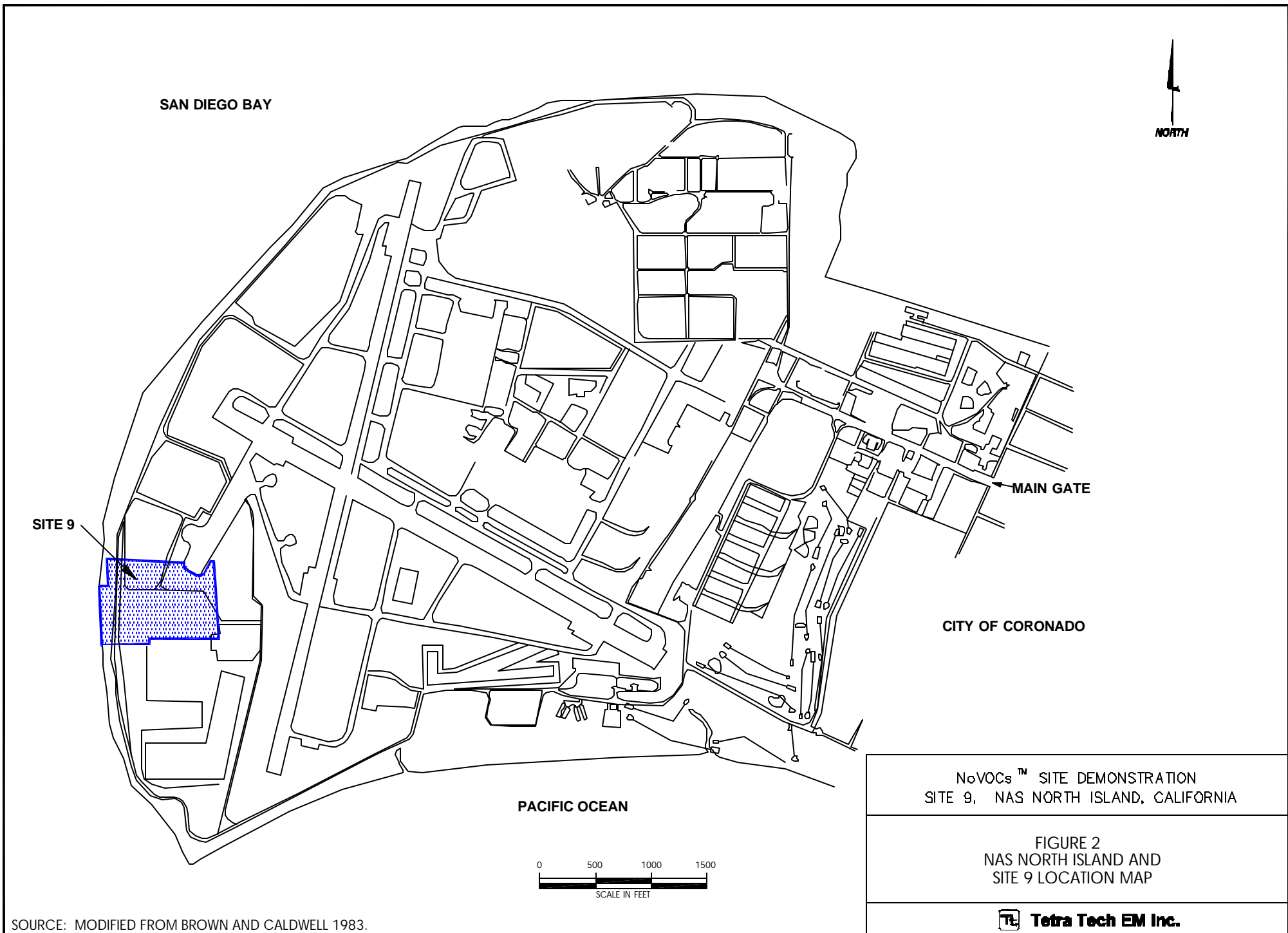







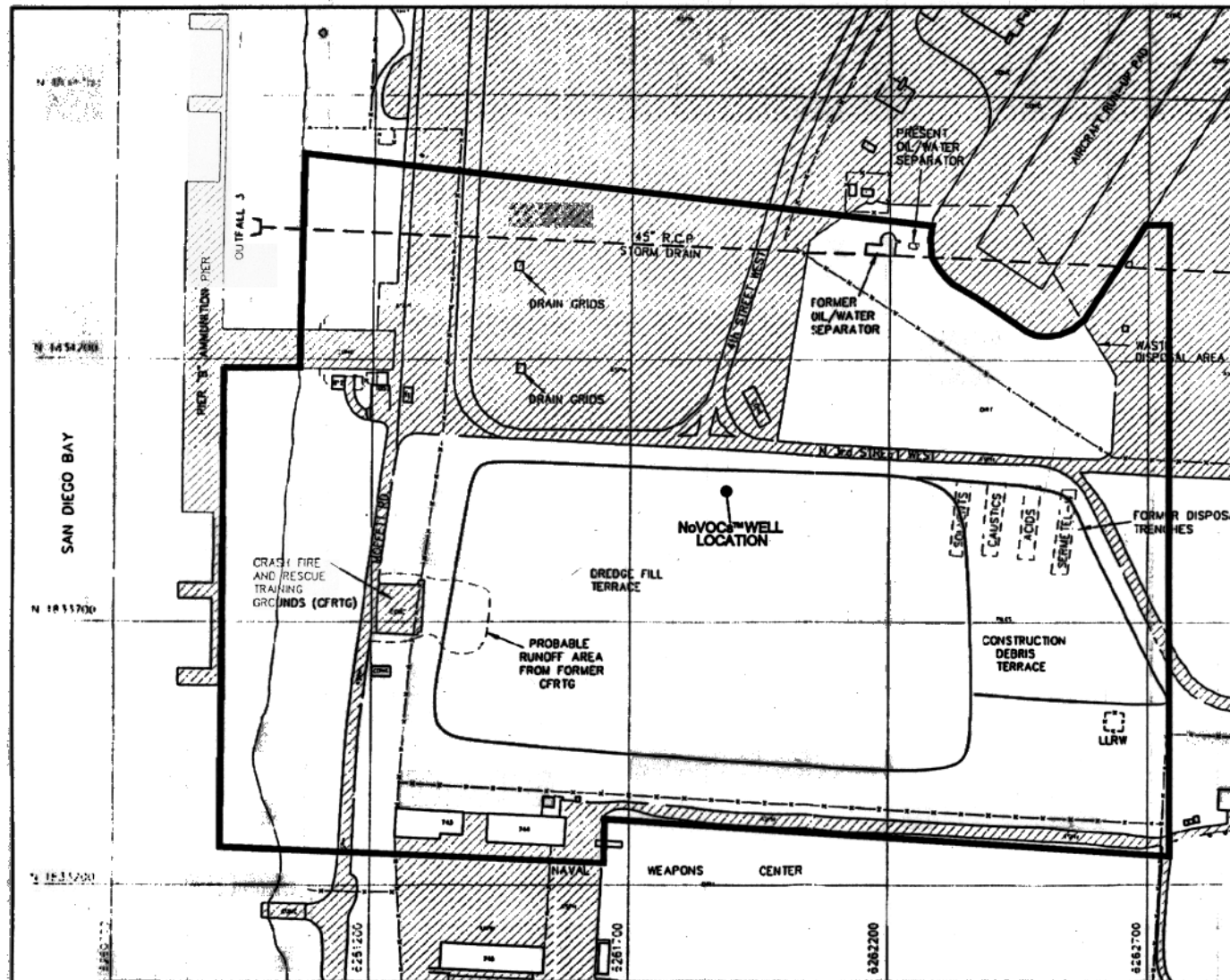

NoVOCs™ SITE DEMONSTRATION
SITE 9, NAS NORTH ISLAND, CALIFORNIA

FIGURE 2
NAS NORTH ISLAND AND
SITE 9 LOCATION MAP

SOURCE: MODIFIED FROM BROWN AND CALDWELL 1983.



LEGEND

-  FENCE
-  ROAD AND STREET
-  BUILDING
-  PAVEMENT (CONCRETE OR ASPHALT)
-  TERRACE BORDERS
-  LLRW
-  STORM DRAIN
-  SITE 9 BOUNDARY

NOTES:

1. BASE MAP ADAPTED FROM PHOTGRAMMETRY BY BECHTEL NATIONAL, INC., 1984.
2. ELEVATION DATUM IS MEAN LOWER LOW WATER.
3. COORDINATES ARE IN THE CALIFORNIA COORDINATE SYSTEM (1983) ZONE 6 BASED ON THE NORTH AMERICAN DATUM (1983).



NOVOCs™ SITE DEMONSTRATION
SITE 9, NAS NORTH ISLAND, CALIFORNIA

FIGURE 3

SITE 9 CHEMICAL WASTE DISPOSAL AREAS

The TER is divided into seven sections. Section 1.0 presents the project background, SITE Program information, technology description, and key contacts. Section 2.0 describes the demonstration site, evaluation objectives, evaluation methods and procedures, and modifications to the NoVOCs™ demonstration Technology Evaluation Plan/Quality Assurance Project Plan (TEP/QAPP) (Tetra Tech 1998). Section 3.0 presents the results of measurements taken during the demonstration. Section 4.0 presents the technology economic analysis. Section 5.0 presents the conclusions of the evaluation, Section 6.0 discusses the technology status, and Section 7.0 includes a list of references.

The TER is appended by six sections, which are divided into six volumes. Appendix A—Auxiliary Tables and Graphs, Appendix B—Vendor Case Studies, and Appendix C—Hydrogeologic Investigation Results, are presented, along with the TER in Volume I. Appendix D—Laboratory Data, are presented in Volumes II through V. Appendix E—Field Data, and Appendix F—Quality Assurance and Quality Control Data Summary, are presented in Volume VI.

1.1 PROJECT BACKGROUND

As part of the feasibility study for the cleanup of the Chemical Waste Disposal Area (Site 9) at NAS North Island, SWDIV is conducting a series of pilot-scale treatability studies to obtain site-specific performance and cost data on potentially applicable remedial technologies to address soil and groundwater contamination at the site. During screening of applicable technologies, the NoVOCs™ technology was identified as a possible remedial solution to treat VOC-contaminated groundwater at Site 9. In addition, an innovative offgas treatment system, the Thermatrix flameless oxidation system, was selected to treat the offgas generated by the NoVOCs™ system. SWDIV, in cooperation with EPA TIO, Clean Sites, and the EPA SITE Program, began project planning of the NoVOCs™ and Thermatrix technology evaluation in 1995. Clean Sites also facilitated an Innovative Technology Public-Private Partnership that includes ICI, DuPont, and General Electric to provide technical review and input during the demonstration. Initiation of the NoVOCs™ demonstration was originally planned for 1997, but because of various regulatory, financial, and technical issues, implementation of the demonstration was delayed until 1998.

Based on site characterization information from Site 9, the initial design for the NoVOCs™ well prepared by EG&G Environmental (EG&G) included the extraction of groundwater from the lower portion of the aquifer and injection of treated water into the vadose zone through an infiltration gallery.

Installation of the NoVOCs™ well at NAS North Island began in October 1997. During advancement of soil borings, a silt layer was encountered at a depth that bisected the treatment zone. Because of concerns that the silt layer may act as a hydraulic barrier at the site and may adversely impact formation of a circulation cell, the location of the NoVOCs™ well was moved about 300 feet southeast, and the well configuration was redesigned.

Installation of the redesigned NoVOCs™ well at the second location began in January 1998. The redesigned well included extraction of groundwater from the lower portion of the aquifer and injection of treated groundwater in the saturation zone, just below the A silt/clay. Before installation of the redesigned well, the NoVOCs™ technology was sold by EG&G Environmental to MACTEC in December 1997. As a result of the sale, a new NoVOCs™ project team was brought in by MACTEC.

In February 1998, installation of the NoVOCs™ well was completed, and the NoVOCs™ technology began system startup and shakedown activities. Bechtel, the environmental support contractor for SWDIV, MACTEC, and Thermatrix managed the installation and operation of the NoVOCs™ well and the offgas treatment systems, with assistance from Gilbert Hill Associates and Umtanum Enterprises. The NoVOCs™ system was installed immediately downgradient from a contaminant source area to treat VOC-contaminated groundwater. Because of geologic conditions encountered during advancement of the NoVOCs™ well and associated monitoring wells, the NoVOCs™ well design was altered during installation to treat a portion of the aquifer instead of the entire aquifer.

On February 26, 1998, the NoVOCs™ system began startup and shakedown activities, which continued through March 9, 1998. On March 13, 1998, the system began continuous operation with only minor interruptions for system checks and balances. The NoVOCs™ system was shut down by MACTEC on March 26, 1998, because the pH control system did not send a high pH shutdown signal to the blower control system.

After MACTEC added a pH shutdown signal, the system was restarted on April 20, 1998. The EPA SITE Program evaluation of the NoVOCs™ system also began in April 1998 and included collection of air and groundwater samples from the NoVOCs™ system and surrounding monitoring points. The evaluation was conducted in accordance with the Technology Evaluation Plan/Quality Assurance Project Plan for the MACTEC NoVOCs™ Technology Evaluation at NAS North Island (Tetra Tech 1998). By June 1998, the pumping rate of the NoVOCs™ system had been reduced from the design rate of 25

gallons per minute (gpm) to about 5 gpm because injection rates above 5 gpm could not be maintained without the water level in the well rising. In addition, during this period, the system experienced numerous shutdowns because of high water levels in the NoVOCs™ well. Based on discussions between the Navy and the technology vendor, the system was shut down on June 19, 1998, to evaluate the cause of the system operating problems. Suspected causes included (1) biofouling or scaling of the screen intervals and formation near the NoVOCs™ system; (2) possible differences in hydraulic characteristics between the upper and lower portions of the aquifer; and (3) design problems with the NoVOCs™ well, in particular, the length of the recharge screen. The Site was particularly challenging because the groundwater contained total dissolved solids (TDS) concentrations ranging from 18,000 to 41,000 mg/L; a much higher TDS than in a typical drinking water aquifer.

To determine if the operating problems were caused by improper well design or aquifer conditions, a series of aquifer pump tests were conducted from July 27 through August 5, 1998. The pump tests provided information on the recharge capacity of the NoVOCs™ system and the aquifer hydraulic characteristics in the vicinity of the NoVOCs™ system. The hydrogeologic study included: (1) a tidal influence study to evaluate natural variations in water level at the site caused by tides in San Diego Bay, and (2) a series of groundwater pumping tests in the shallow and deep portions of the aquifer, including step drawdown tests, a 32-hour constant discharge pumping test, an injection test, and a dipole flow test to evaluate the aquifer characteristics in the vicinity of the NoVOCs™ system. A biofouling and scaling study was also conducted by the vendor.

Based on the results of these studies, it was determined that the initial well design would be modified to allow for more efficient air-water separation and a sequestering agent would be added to the system to minimize metal precipitation. Significant biological growth was noted during pump test activities, so it was decided that a periodic biocide treatment would also be added to the groundwater flowing through the system. The internal components of the NoVOCs™ well were redesigned by MACTEC and were installed in September 1998.

Operation of the redesigned NoVOCs™ system was initiated on September 24, 1998, using a modified chemical treatment, which consisted of acid and biocide injection into the influent piezometer to control the precipitation of iron and biological growth near the NoVOCs™ well. The redesigned system continued operation until October 29, 1998. During this period, the system continued to experience

problems with high water levels in the NoVOCs™ well and was not able to operate for sustained periods of time. As a result of inconsistent operation, completion of planned evaluation activities, including the dye trace study and collection of groundwater and air samples to evaluate system performance, were postponed until satisfactory operating conditions could be achieved.

A project team meeting was held in San Diego, California, on November 9 and 10, 1998, to discuss system operating problems and continued evaluation of the NoVOCs™ system. At the meeting, MACTEC indicated that they were not willing to commit additional resources to making the NoVOCs™ system work at NAS North Island and withdrew from the demonstration. However, SWDIV decided to continue operation of the NoVOCs™ system and modified the chemical treatment used to control metal precipitation and biological growth in an effort to get the system operational and continue the evaluation of the system.

On December 4, 1998, the NoVOCs™ system was restarted. During operation of the NoVOCs™ system, the well was aggressively treated with hydrochloric acid, citric acid, bromide/chloride solution, and hydrogen peroxide to mitigate biofouling and precipitation of iron. However, even with aggressive chemical treatment, the system continued to experience operational shutdowns because of high water levels in the NoVOCs™ well. In addition, the Thermatrix system began to experience maintenance problems that also adversely affected operation of the NoVOCs™ system. Finally, on January 4, 1999, the NoVOCs™ demonstration was terminated by SWDIV because of continued operating problems associated with biofouling of the NoVOCs™ well.

1.2 THE SUPERFUND INNOVATIVE TECHNOLOGY EVALUATION PROGRAM

The SITE Program was established by EPA's Office of Solid Waste and Emergency Response (OSWER) and Office of Research and Development (ORD) in response to the Superfund Amendments and Reauthorization Act of 1986 (SARA). The SITE Program promotes the development, evaluation, and use of new or innovative technologies to clean up Superfund sites across the country.

The SITE Program's primary purpose is to maximize the use of alternatives in cleaning up hazardous waste sites by encouraging the development and evaluation of innovative treatment and monitoring technologies. It consists of three major elements:

- The Technology Evaluation Program
- The Monitoring and Measurement Technologies Program
- The Technology Transfer Program

The objective of the Technology Evaluation Program is to develop reliable performance and cost data on innovative technologies so that potential users may assess the technology's site-specific applicability. Technologies evaluated are either currently available or close to being available for remediation of Superfund sites. SITE evaluations are conducted on hazardous waste sites under conditions that closely simulate full-scale remediation conditions, thus ensuring the usefulness and reliability of information collected. Data collected are used to assess: (1) the performance of the technology, (2) the potential need for pre- and post-treatment processing of wastes, (3) potential operating problems, and (4) approximate costs. The evaluations also allow for assessment of long-term risks.

Existing technologies that improve field monitoring and site characterizations are identified in the Monitoring and Measurement Technologies Program. New technologies that provide faster, more cost-effective contamination and site assessment data are supported by this program. The Monitoring and Measurement Technologies Program also formulates protocols and standard operating procedures for evaluation methods and equipment.

The Technology Transfer Program disseminates technical information on innovative technologies in the Evaluation and Monitoring and Measurements Technologies Programs through various activities. These activities increase the awareness and promote the use of innovative technologies for assessment and remediation at Superfund sites. The goal of technology transfer activities is to develop interactive communication among individuals requiring up-to-date technical information.

1.3 TECHNOLOGY DESCRIPTION

MACTEC's NoVOCs™ system is a patented in-well stripping process (U.S. Patent No. 5,180,503) for in situ removal of VOCs from groundwater. A schematic of the treatment process is shown in Figure 4. In this process, air injected into a specially designed well simultaneously creates an airlift pump and an in situ stripping reactor to circulate and remediate groundwater (EG&G 1996).

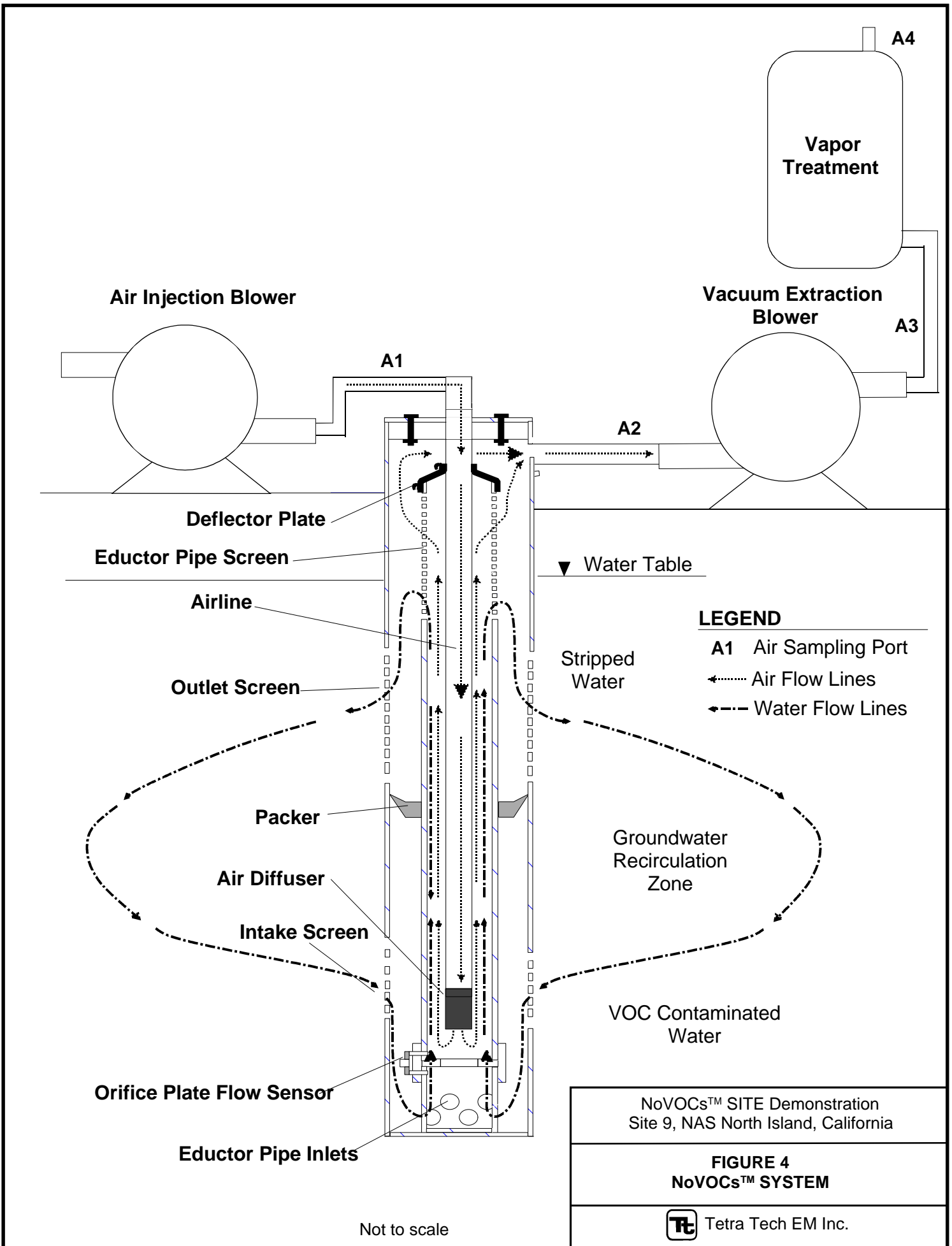

The NoVOCs™ system at NAS North Island consisted of a well casing installed in the contaminated saturated zone, with screened intervals below the water table and an air injection line extending into the groundwater within the well. Contaminated groundwater enters the well through the lower screen and is pumped upward within the well by pressurized air supplied through the air injection line, creating an air-lift pump effect. As the water is air-lifted within the well, dissolved VOCs in the water volatilize into the air space at the air-water interface. The treated water rises to a deflector plate and is forced out of the upper screen. Treated water is recharged to the aquifer, and stripped VOC vapors are removed from the subsurface by a vacuum applied to the upper well casing. At NAS North Island, the stripped vapors were treated by the Thermatrix flameless oxidation process (EG&GE 1996) and discharged to the atmosphere. Other open- and closed-loop offgas treatment systems can be used with the NoVOCs™ technology, and the Thermatrix system is not an integral part of the NoVOCs™ treatment system. The equipment used to operate the NoVOCs™ system, including blowers, control panel, and air temperature, pressure, and flow rate gauges, was housed in an on-site control trailer.

The NoVOCs™ well may be used to remediate contaminant source areas or as a groundwater interdiction system to prevent further migration of a contaminant plume. At NAS North Island, one NoVOCs™ well was installed to remediate a portion of the aquifer downgradient from a contaminant source area. Two piezometers and 10 monitoring wells were also installed to enable sample collection in support of the evaluation of the NoVOCs™ system. Figure 5 shows a plan view of the location of the NoVOCs™ system well and associated piezometers and monitoring wells. Figure 6 shows a generalized cross-section of the NoVOCs™ system well, piezometers, and crossgradient monitoring wells.

MACTEC claims that the NoVOCs™ system can reduce effluent groundwater VOC concentrations to below federal maximum contaminant levels (MCL) if the contaminant source has been removed. Because dense nonaqueous-phase liquids (DNAPL) may be present in the aquifer at this evaluation site and may act as a continuing source of groundwater contamination, MACTEC did not make any claims for the reduction of dissolved VOC concentrations in groundwater at Site 9. Given the designed pumping rate of 25 gpm and a total air flow rate of 120 standard cubic feet per minute (scfm), MACTEC estimated that the effective radius of the circulation cell established by the NoVOCs™ system at this site would be at least 90 feet (EG&GE 1997). In addition, the vendor claimed that the NoVOCs™ system would remove more than 80 percent of the VOCs that pass through the system.



4th STREET WEST

EXISTING SVE PAD

NoVOCS-THERMATRIX
EQUIPMENT PAD

PROPANE TANKS

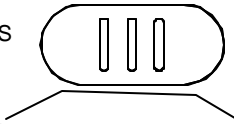

N 3rd STREET WEST

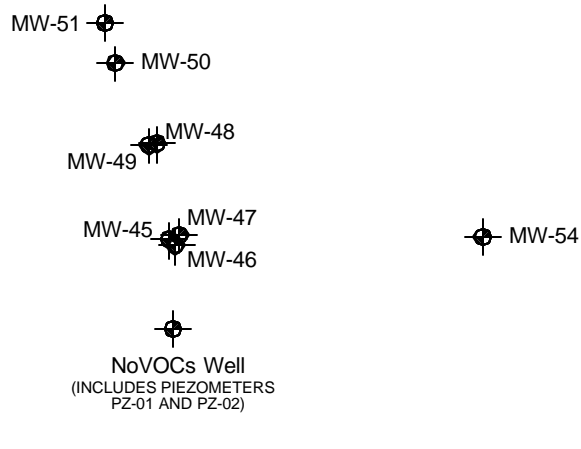

LEGEND



APPROXIMATE LOCATION OF
MONITORING WELL OR NoVOCS WELL



NoVOCS™ SITE DEMONSTRATOR
SITE 9, NAS NORTH ISLAND, CALIFORNIA

FIGURE 5
WELL LOCATIONS

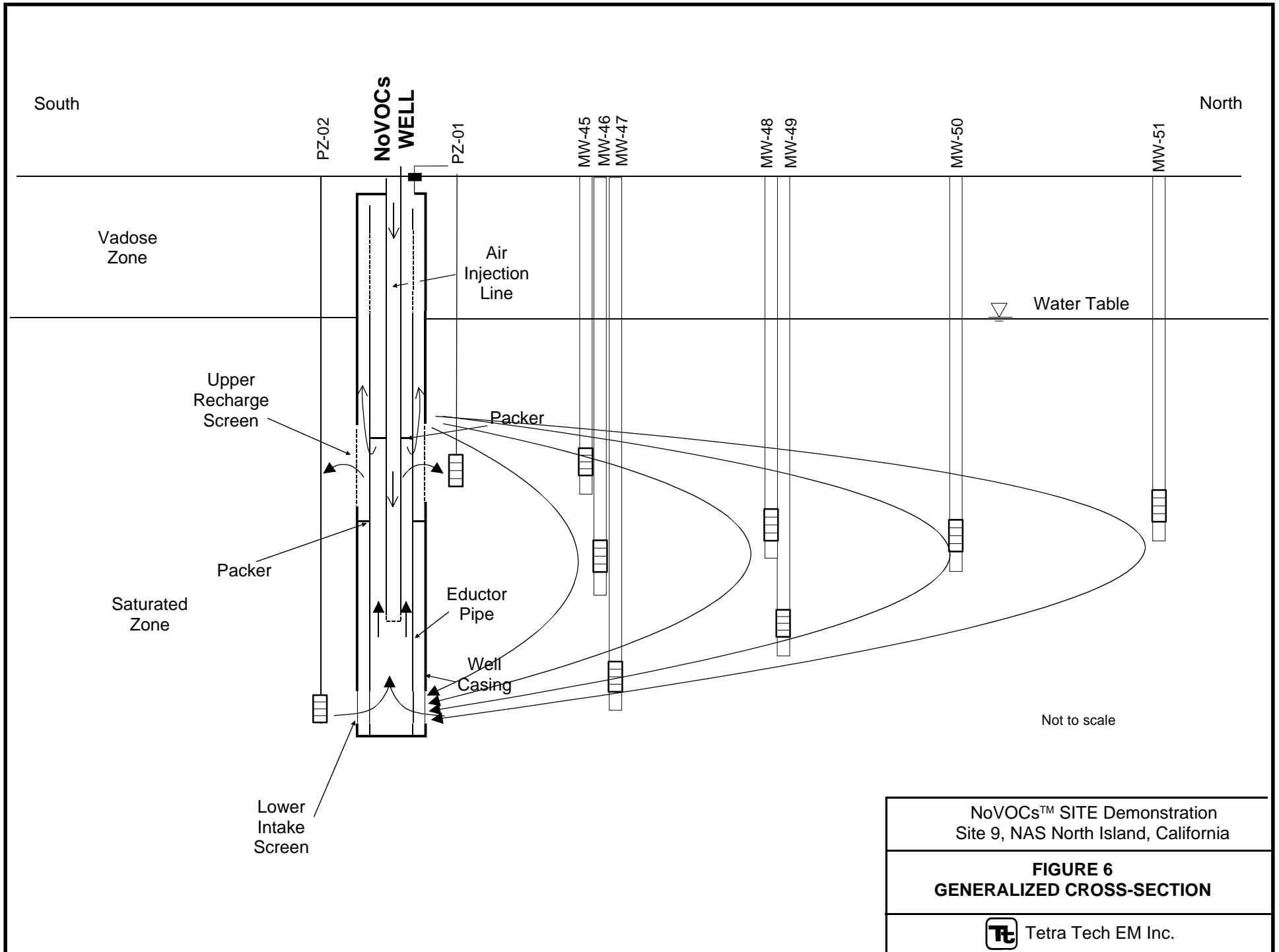

1.4

KEY CONTACTS

Additional information on the SITE Program and the evaluation can be obtained from the NRMRL

Project Manager:

- Michelle Simon, P.E.
U.S. Environmental Protection Agency
Office of Research and Development
26 West Martin Luther King Drive
Cincinnati, Ohio 45268
Telephone: (513) 569-7469, Facsimile: (513) 569-7676
E-mail: simon.michelle@epa.gov

Additional information on the NoVOCs™ technology or the evaluation can be obtained from the technology vendor:

- Warren Schultz
MACTEC, Inc.
1819 Denver West Drive, Suite 400
Golden, Colorado 80401
Telephone: (303) 278-3100, Facsimile: (303) 273-5000
E-mail: w Schultz@maccorp.com

In addition, information on the SITE Program is available through the following on-line information clearinghouses:

- SITE Program Home Page: <http://www.epa.gov/ORD/SITE>
- The Alternative Treatment Technology Information Center (ATTIC) Internet Access: <http://www.epa.gov/attic>
- Cleanup Information Bulletin Board System (CLU-IN)
Help Desk: (301) 589-8368; Internet Access: <http://www.clu-in.org>
- EPA Remediation and Characterization Innovative Technologies
Internet Access: <http://www.epa.reachit.org>
- Groundwater Remediation Technology Center
Internet Access: <http://www.gwrtac.org>

Technical reports may be obtained by contacting the National Service Center for Environmental Publications (NSCEP) in Cincinnati, Ohio. To find out about newly published documents or to be placed on the SITE mailing list, call or write to:

C U.S. EPA/NSCEP
P.O. Box 42419
Cincinnati, OH 45242-2419
(800) 490-9198

2.0 SITE DESCRIPTION, OBJECTIVES, AND PROCEDURES

Demonstration site background, objectives, and methods and procedures for the NoVOCs™ technology evaluation are described in the following sections.

2.1 DEMONSTRATION SITE DESCRIPTION

This section provides information on site conditions, including site history, topography, geology, hydrogeology, and soil and groundwater contamination at NAS North Island and Site 9.

2.1.1 Site History

NAS North Island is the largest naval aviation complex on the West Coast and is home to three aircraft carriers and the Third Fleet flagship, USS Coronado. NAS North Island is located at the northern end of the peninsula that forms San Diego Bay and is bordered by the City of Coronado to the east, the Pacific Ocean to the south, and San Diego Bay to the north and west (see Figure 1). The 2,806-acre complex, officially commissioned in 1917, provides aviation support services to the fleet, aircraft maintenance, airfield operations, pierside services, and logistics. The mission of NAS North Island is to maintain and operate facilities and to provide services and material that support operation of aviation activities and units of the Operating Forces of the Navy, as well as other units, as designated by the Chief of Naval Operations.

Past hazardous waste disposal practices at NAS North Island have resulted in soil and groundwater contamination. The Navy has undertaken investigations to determine the extent of contamination and possible cleanup methods as part of the IR Program. Under the IR Program, 14 contaminated areas have been designated IR sites, one of which is Site 9 (see Figure 2).

Site 9, the 40-acre former chemical waste disposal area, is located on the western end of NAS North Island. Site 9 operated from the 1940s to the mid-1970s and consisted of three major waste disposal areas: a shallow pit used for disposal of liquid wastes (located within the waste disposal area shown in Figure 3); four parallel trenches, each containing different types of wastes (solvents, caustics, acids, and semisynthetics consisting of ceramic and metallic compounds); and a large unimproved area used for

burying drums containing unidentified chemical wastes, located south of the NoVOCs™ well. An estimated 8 to 24 million gallons of waste were disposed of at Site 9 over its 30 years of operation (Jacobs 1995a).

Contamination from these disposal areas has migrated to the underlying groundwater. Although no official history of chemical disposal exists for most of Site 9 outside of the three disposal areas, groundwater contamination is widespread throughout the site. Elevated levels of chlorinated solvents and their breakdown products, as well as petroleum hydrocarbons and metals, are present in groundwater at Site 9. Based on the high dissolved concentrations of chlorinated solvent compounds, the presence of DNAPL in the subsurface is suspected (Jacobs 1995a).

The Navy selected a location immediately south of the intersection of 4th Street West and North 3rd Street West to install the NoVOCs™ system (see Figure 3). Cone penetrometer test (CPT) boreholes advanced at the proposed NoVOCs™ location provided additional characterization of subsurface lithology and confirmed that significant groundwater contamination was present (Bechtel 1998).

2.1.2 Site Topography





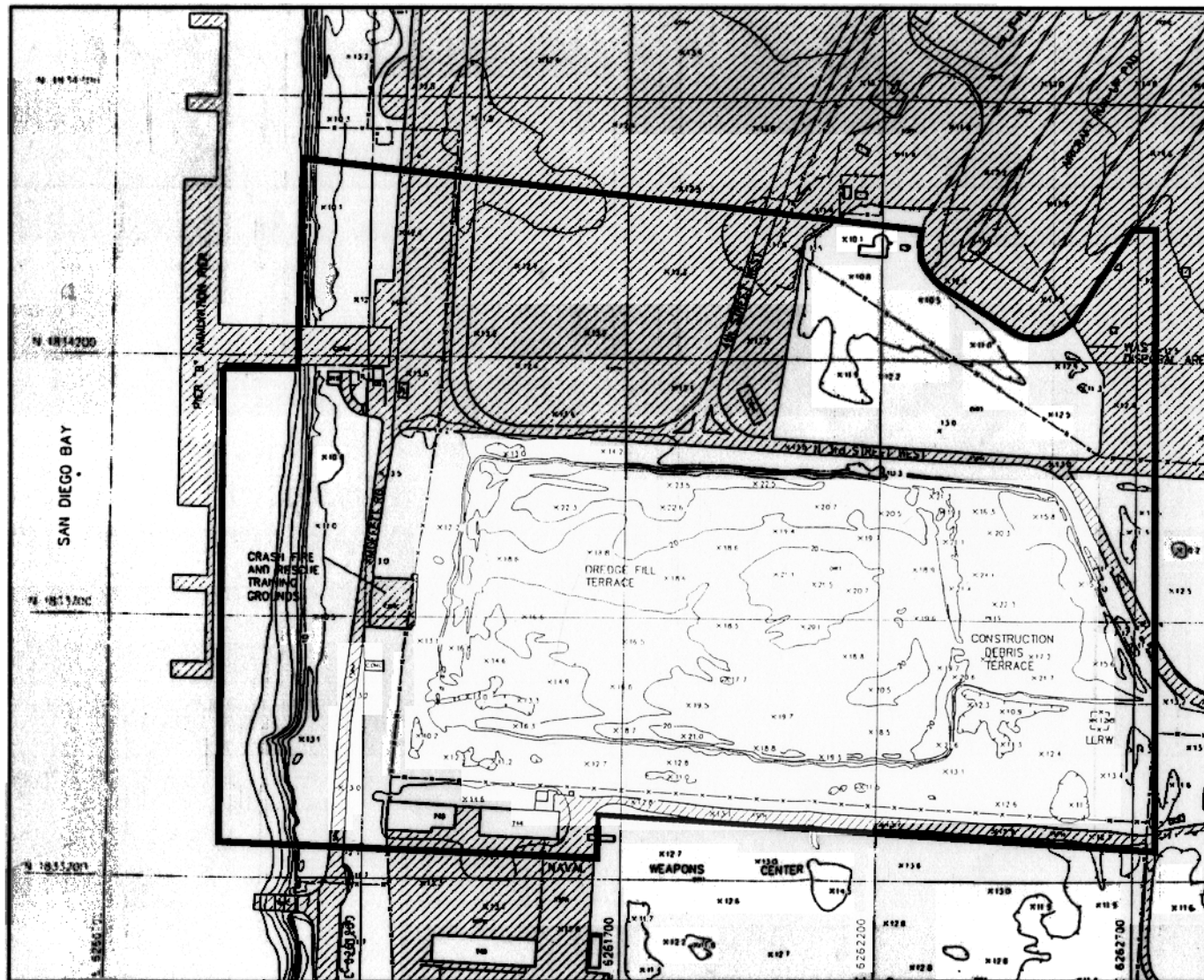

The topography of the northern half of Site 9 is relatively flat with an elevation of about 13 feet above mean lower low water (MLLW). It has virtually no relief and is covered by asphalt paving. The southern half of the site is unpaved and is almost entirely covered by a terrace composed of hydraulic dredge spoils. The terrace has an elevation of about 23 feet above MLLW along its northern face and slopes gently southward to about 18 feet above MLLW (Jacobs 1994). Topographic elevations and surface features are shown in Figure 7. The NoVOCs™ well was installed on the terrace at a surface elevation of about 22 to 23 feet above MLLW.

2.1.3 Regional and Site Geology

This section discusses the regional and site geology for Site 9.



LEGEND

	20	CONTOUR LINE
		FENCE
		ROAD AND STREET
		BUILDING
X 12.3		SPOT ELEVATION
		PAVEMENT (CONCRETE OR ASPHALT)
LLRW		LOW-LEVEL RADIOACTIVE WASTE STORAGE AREA
		SITE 9 BOUNDARY

- NOTES:**
1. BASE MAP ADAPTED FROM PHOTGRAMMETRY BY BECHTEL NATIONAL, INC., 1994.
 2. ELEVATION DATUM IS MEAN LOWER LOW WATER.
 3. COORDINATES ARE IN THE CALIFORNIA COORDINATE SYSTEM (1983) ZONE 6 BASED ON THE NORTH AMERICAN DATUM (1983).



NOVOCs™ SITE DEMONSTRATION
SITE 9, NAS NORTH ISLAND, CALIFORNIA

FIGURE 7
SITE 9 TOPOGRAPHIC ELEVATIONS

2.1.3.1 Regional Geology

NAS North Island is situated in the coastal portion of the Peninsular Range Geomorphic Province. This region is underlain by a basement complex of late Cretaceous undifferentiated igneous rocks of the Southern California Batholith and Jurassic prebatholithic metavolcanic rocks. The basement complex is nonconformably overlain by a sedimentary succession of marine and nonmarine rocks that were deposited within the San Diego embayment. These rocks range in age from Late Cretaceous to Recent. The most abundant deposits of the embayment are gently folded and faulted Eocene marine, lagoonal, and nonmarine rocks that thin eastward and trend northwest (Jacobs 1995b).

2.1.3.2 Site Geology

Site 9 is underlain by artificial fill to a depth of about 15 feet below ground surface (bgs) in the vicinity of the NoVOCs™ well. The artificial fill in this area varies in thickness. The terrace in the southern portion of the site is composed of hydraulic fill derived from dredging the San Diego Bay and consists of fine-grained, loose sand. In addition, in the immediate vicinity of the site, the former Whaler's Bight, a shallow lagoon formerly present at the western edge of North Island, was filled with sediments during the early part of the twentieth century. Below the fill material is the Bay Point Formation, a poorly consolidated, fine- and medium-grained fossiliferous sandstone (Kennedy 1975).

The depositional environment of the Bay Point Formation at the site was lagoonal and shallow marine. Sediment accumulated on the southern portion of North Island generally from northward transport of sediment along the shore. As described below, most of the uppermost sediments at the site are composed of fine-grained sand, with varying amounts of silt and medium-grained sand. Two thin silt and clay layers are present in the subsurface at the site and are likely to be continuous in the vicinity of the site, based on observations in the numerous borings and wells installed at the site (Bechtel 1998).

The first fine-grained layer is a thin (2-to 5-feet-thick) clay, silt, and clayey sand layer designated as A clay/silt (Jacobs 1994). The A clay/silt occurs at about 35 to 40 feet bgs and is present beneath Site 9 (Jacobs 1994). Recent investigations by Bechtel have indicated that the A clay/silt is continuous from the proposed NoVOCs™ well locations west to the shoreline wells. Beneath the unconsolidated sediments is a sandstone layer at about 90 feet bgs. The second layer is the B clay, located about 105 feet

bgs, that also appears to be continuous in the vicinity of the site. The location of a geologic cross-section is shown in Figure 8, and the cross-section depicting the subsurface geology of the site is shown in Figure 9.

Boring S9-SB-34 located near the NoVOCs™ well encountered mostly sand and silty sand. The A clay/silt layer was encountered at 35.5 feet bgs, dense sands were encountered between 60 and 61 feet bgs and 65 to 67.5 feet bgs, and a thin, cemented sandstone layer was encountered at 79 feet bgs. In addition, the sand fractions of the sands and silty sands ranged from very fine- to coarse-grained and contained various quantities of shell fragments. The log for boring S9-SB-34 is provided in Volume VI, Appendix E.

2.1.4 Site Hydrogeology







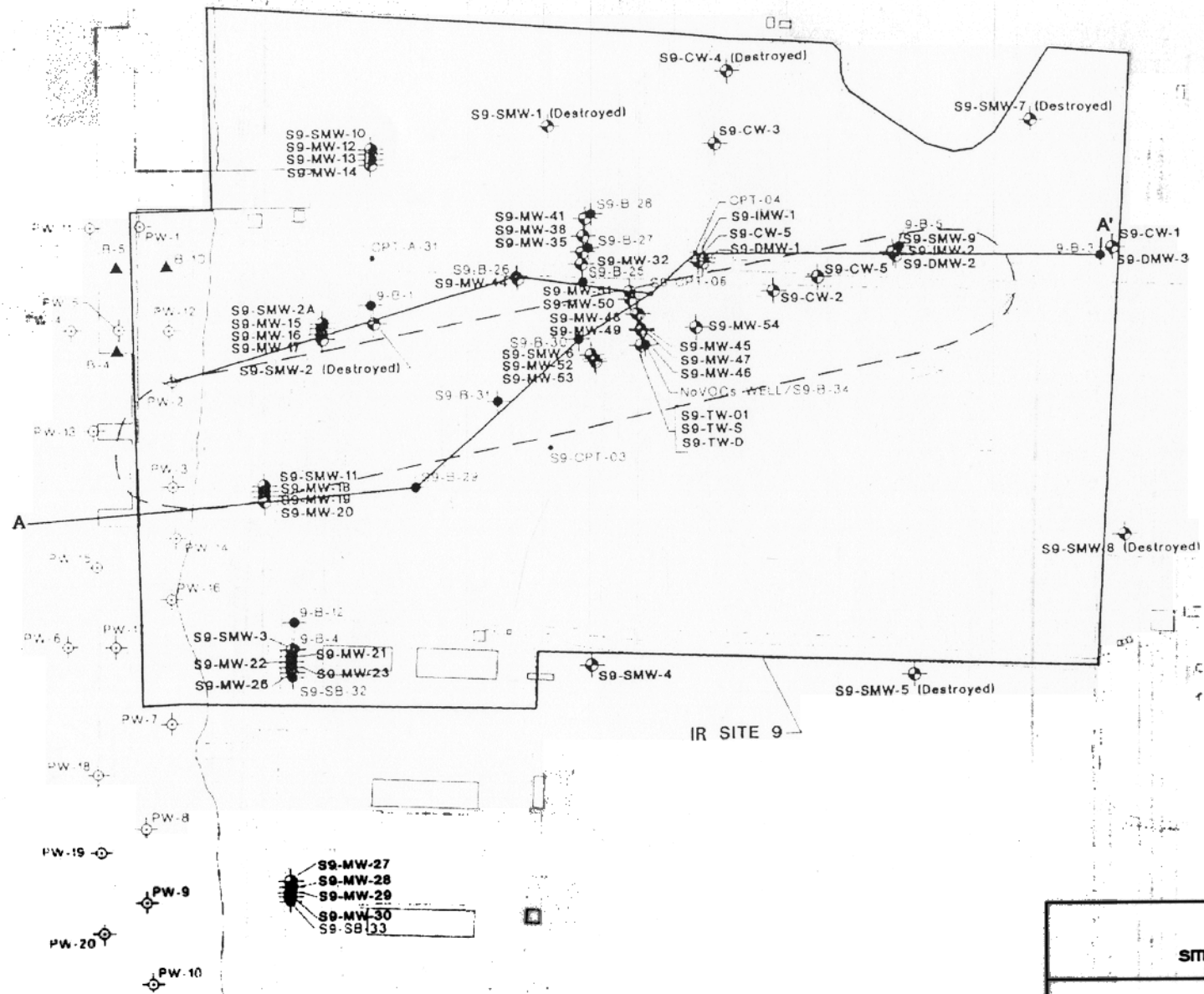

The generally accepted hydrogeologic conceptual model for islands and peninsulas surrounded by salt water is a lens-shaped body of fresh water resting isostatically atop saltwater because of density differences. At Site 9, groundwater occurs at about 8 feet bgs (5 feet above MLLW). The upper 110 feet of the saturated zone contains an unconfined aquifer with a thin (5 to 20 feet), discontinuous freshwater lens, a brackish mixing zone (30 to 100 feet), and a saltwater wedge intruding inland. The reported values for some of the hydrogeological parameters of the site are as follows (Jacobs 1995b):

- C Hydraulic Gradient: 0.0008 foot per foot (ft/ft) over most of the site, but steepens near the shoreline to 0.006 ft/ft
- C Transmissivity: 1,195 square feet per day (ft²/day)
- C Specific Yield: 3.2×10^{-1} (dimensionless)
- C Hydraulic Conductivity: 12 feet per day (ft/day) or 4.2×10^{-3} centimeters per second (cm/sec)
- C Effective Porosity: 0.25 (dimensionless)

These were the hydrogeologic parameters used to design the NoVOCs™ well installed at NAS North Island. The possibility that the A clay/silt layer posed a hydraulic barrier to effective groundwater



LEGEND

-  MONITORING WELLS
-  OFF-SHORE PORE WATER SAMPLE
-  GEOTECHNICAL BORING FROM AMMUNITIONS PIER CONSTRUCTION, 1975
-  CONTINUOUS COREHOLE
-  CONE PENETROMETER TEST
-  IRP SITE BOUNDARY
-  ESTIMATED EXTENT OF VOC MIGRATION PATHWAY AT DEPTH OF 65' TO 80' BGS
-  GEOLOGIC GROSS SECTION LINE

NOVOCs™ SITE DEMONSTRATION
SITE 9, NAS NORTH ISLAND, CALIFORNIA

FIGURE 8
GEOLOGIC CROSS-SECTION LOCATION

SOURCE: MODIFIED FROM BECHTEL (1998)

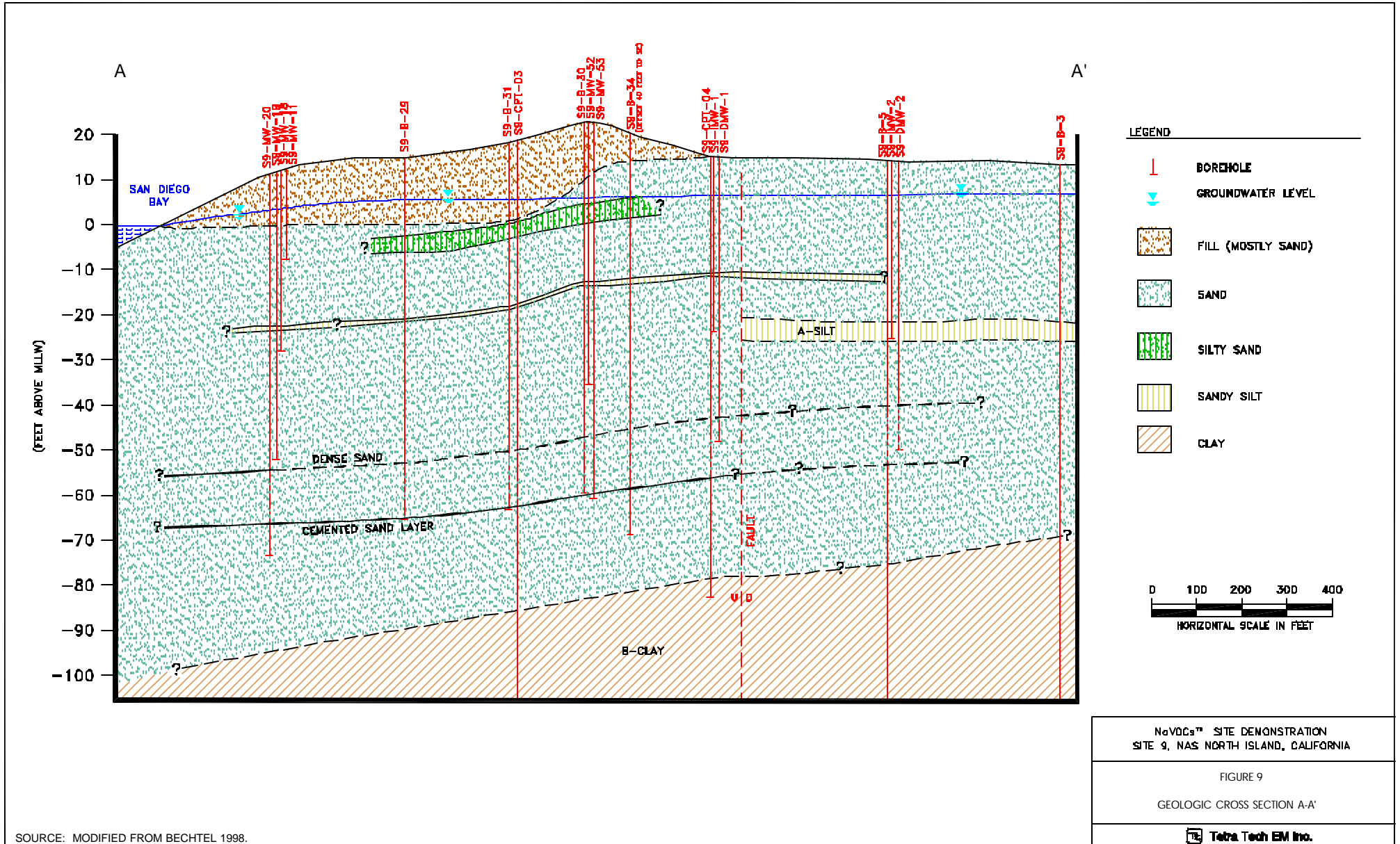

SOURCE: MODIFIED FROM BECHTEL 1998.

circulation also impacted the design of the well and resulted in an installation with both extraction and recharge occurring in the saturated zone under the A clay/silt.

In general, the hydraulic gradient is toward the west, varying between southwest and northwest and is tidally influenced. The distribution of groundwater contamination also suggests that the general flow of groundwater is toward the west. Contaminants associated with the site have been detected in pore water of San Diego Bay, west of Site 9 (SPAWAR Systems Center 1998). A survey of pore water concentrations of VOCs was conducted in the spring of 1998 in the upper 5 feet of sediment adjacent to and west of Site 9. The results of the survey documented that VOCs were present in the pore water at depths of about 20 to 30 feet below MLLW. The data suggest that contaminants are migrating west from Site 9, at a depth consistent with the A clay/silt layer, and discharging to the bay through pore water interchange with the bay water (Bechtel 1998).

2.1.5 Soil and Groundwater Contamination

Groundwater at NAS North Island is saline, with concentrations ranging from 18,000 to 41,000 mg/L. Based on findings from previous investigations at the site (Jacobs 1995a, 1995b), high concentrations of chlorinated solvents, chlorinated solvent breakdown products, petroleum hydrocarbons, and metals are present in the saturated and unsaturated zones. The major contaminants detected in groundwater are chlorinated aliphatic hydrocarbon solvents (tetrachloroethene [PCE], trichloroethene [TCE], and 1,1,1-trichloroethane) and their breakdown products (dichloroethane, dichloroethene [DCE], and vinyl chloride); lower concentrations of aromatic hydrocarbons (benzene, toluene, ethylbenzene, and xylenes [BTEX]); and heavy metals. Because of the high concentrations of chlorinated solvent compounds in groundwater above the B clay, DNAPL occurrences are suspected at several locations beneath Site 9. If present, DNAPL may act as a long-term source of dissolved-phase contamination in the unconfined aquifer.

Contaminants in soils consist of heavy metals, VOCs, and semivolatile organic compounds (SVOC). Eighteen priority pollutant VOCs have been detected in soil samples with individual compound concentrations of up to 3,600 milligrams per kilogram (mg/kg). Fourteen priority pollutant SVOCs, including polynuclear aromatic hydrocarbons (PAH), have been detected in soil samples with individual compound concentrations up to 1,668 mg/kg. In the former release areas, soils reportedly are virtually

saturated with VOCs (Jacobs 1995a). In addition, large quantities of VOCs are believed to have evaporated from saturated soils and groundwater into the vadose zone. Elevated levels of TCE, PCE, and toluene have been detected in soil gas within the vadose zone (Jacobs 1995a).

2.2 EVALUATION OBJECTIVES

The SITE evaluation was designed to address primary and secondary objectives selected for the NoVOCs™ technology. These objectives were selected to provide potential users of the NoVOCs™ technology with the necessary technical information to assess the performance of the treatment system. For the SITE evaluation of the NoVOCs™ technology, three primary and seven secondary objectives were selected and are summarized below:

Primary Objectives:

- P1** Evaluate the removal efficiency of the NoVOCs™ well system for VOCs in groundwater.
- P2** Determine the radial extent of the NoVOCs™ treatment cell.
- P3** Quantify the average monthly total VOC mass removed from groundwater treated by the system for 6 months.

Secondary Objectives:

- S1** Quantify the changes in VOC concentrations in the groundwater within the NoVOCs™ treatment cell.
- S2** Document changes in selected geochemical parameters that may be affected by the NoVOCs™ system.
- S3** Document NoVOCs™ system operating parameters.
- S4** Document pre- and post-treatment VOC concentrations and system operating parameters in the Thermatrix flameless oxidation offgas treatment system.
- S5** Document the hydrogeologic characteristics at the treatment site.
- S6** Document the changes in pressure head in the aquifer caused by the NoVOCs™ system.

- S7** Estimate the capital and operating costs of constructing the NoVOCs™ system and Thermatrix flameless oxidation process and maintaining them for 6 months.

The objectives were evaluated by collecting weekly and monthly samples from the groundwater and system offgas, as well as conducting a series of pump tests. To meet the evaluation objectives, data were collected and analyzed using the methods and procedures summarized in Section 2.3.

2.3 EVALUATION METHODS AND PROCEDURES

This section describes the methods and procedures used to collect and analyze samples for the SITE evaluation of the NoVOCs™ technology. Field and analytical methods used to collect and analyze samples were as outlined in Sections 2.3.2, 2.3.3., and 2.3.4. Activities associated with the NoVOCs™ SITE evaluation included (1) field equipment installation, (2) evaluation design, (3) groundwater and soil gas sample collection and analysis, and (4) field and laboratory quality assurance and quality control (QA/QC).

2.3.1 Field Equipment Installation

Predemonstration activities conducted by SWDIV's support contractor, Bechtel, included (1) advancement of a CPT and collection of groundwater samples to evaluate the geology and contaminant distribution at the demonstration site, (2) continuous coring and installation of the NoVOCs™ well and two adjacent piezometers, and (3) the drilling of 10 soil borings and subsequent installation and completion of the borings into monitoring wells. The depths and locations of the piezometers and monitoring wells are described below.

The two piezometers were installed within the sand pack of the NoVOCs™ well: one adjacent to the NoVOCs™ recharge screen (PZ-01), and one adjacent to the NoVOCs™ intake screen (PZ-02). The natural groundwater flow direction across the site is generally to the west. Seven crossgradient monitoring wells were installed at four distances from the NoVOCs™ well, as follows: a cluster of three wells 30 feet from the NoVOCs™ well (monitoring wells MW-45, MW-46, and MW-47), a well pair 60 feet from the NoVOCs™ well (monitoring wells MW-48 and MW-49), and single monitoring wells 90 and 105 feet from the NoVOCs™ well (monitoring wells MW-50 and MW-51). Two downgradient monitoring wells (MW-52 and MW-53) were installed as a pair about 100 feet from the NoVOCs™ well,

and a single monitoring well (MW-54) was also installed 100 feet upgradient of the NoVOCs™ well. Each monitoring well was screened at one of the following three intervals: at the top of the treatment zone (between about 41 and 47 feet bgs [-19.1 to -25.0 feet MLLW]), in the middle of the treatment zone (between about 49 and 62 feet bgs [-35.1 to -40.4 feet MLLW]), and at the bottom of the treatment zone (between about 67 and 78 feet bgs [-43.6 to -58.0 feet MLLW]). These screen intervals provided information on changes in contaminant concentrations through the aquifer. A summary of well screen intervals for the individual wells is presented in Table 1.

2.3.2 Evaluation Design

This section describes the sampling and analysis program and sample collection frequency and locations. The purpose of the demonstration design was to collect and analyze samples of known and acceptable quality to achieve the objectives stated in Section 2.2.

2.3.2.1 Sampling and Analysis Program

To meet the demonstration objectives, the sampling and analysis program was divided into three phases: (1) baseline sampling, (2) long-term sampling, and (3) dye trace sampling.

Baseline Sampling. Baseline sampling included the collection of groundwater samples from the monitoring wells to determine VOCs, SVOCs, dissolved metal concentrations, and select geochemical parameters at the start and end of the evaluation. Data obtained during the baseline sampling events were used to achieve secondary objectives S1 and S2. The first baseline sampling was conducted in April 1998 to assess contaminant concentrations in the aquifer before startup of the NoVOCs™ system under early operating conditions. A second baseline sampling event was conducted in September 1998 to assess contaminant concentrations in the aquifer before startup of the NoVOCs™ system under reconfigured operating conditions. An overview of the sampling and analysis conducted for baseline sampling is shown in Table 2.

TABLE 1

**WELL SCREEN INTERVALS
 NoVOCs™ SITE Demonstration
 Site 9, NAS North Island, California**

Well	Description	Distance From NoVOCs™ Well (feet)	Screen Interval Depths (feet bgs)	Designation
IW-01	NoVOCs™ well	0	43 to 47 and 72 to 78	System well
PZ-01	NoVOCs™ recharge piezometer	0	40 to 45	Shallow
PZ-02	NoVOCs™ intake piezometer	0	70 to 75	Deep
MW-45	Crossgradient monitoring well	30	42 to 47	Shallow
MW-46	Crossgradient monitoring well	30	57 to 62	Intermediate
MW-47	Crossgradient monitoring well	30	72 to 77	Deep
MW-48	Crossgradient monitoring well	60	52 to 57	Intermediate
MW-49	Crossgradient monitoring well	60	67 to 72	Deep
MW-50	Crossgradient monitoring well	90	52 to 57	Intermediate
MW-51	Crossgradient monitoring well	105	49 to 54	Intermediate
MW-52	Downgradient monitoring well	100	41 to 46	Shallow
MW-53	Downgradient monitoring well	100	72 to 77	Deep
MW-54	Upgradient monitoring well	100	38 to 78	Shallow

Note:

bgs Below ground surface

TABLE 2

**SAMPLING AND ANALYSIS SUMMARY
NoVOCs™ SITE Demonstration
Site 9, NAS North Island, California**

Sampling Event	Sampling Location	Sample Type	Analytical Parameter	Sampling Frequency	Where Analyzed	Method	Purpose
Baseline Sampling Event	PZ-01 and PZ-02 and MW-45 through MW-54	Groundwater	VOCs	Before and after demonstration of the NoVOCs™ technology	Laboratory	8260B (SW-846)	S2
			SVOCs		Laboratory	8270 (SW-846)	S2
			Dissolved metals		Laboratory	3010/6010B (SW-846)	S2
			Dissolved organic carbon		Laboratory	9060 SW-846	S2
			Alkalinity		Laboratory	310.1 (MCAWW)	S2
			Total dissolved solids		Laboratory	160.1 (MCAWW)	S2
			Dissolved oxygen		In field	360.1 (MCAWW)	S2
			Redox potential		In field	2580B (APHA)	S2
			pH		In field	150.1 (MCAWW)	S2
			Specific conductivity		In field	120.1 (MCAWW)	S2
			Temperature		In field	170.1 (MCAWW)	S2

TABLE 2 (Continued)

**SAMPLING AND ANALYSIS SUMMARY
NoVOCs™ SITE Demonstration
Site 9, NAS North Island, California**

Sampling Event	Sampling Location	Sample Type	Analytical Parameter	Sampling Frequency	Where Analyzed	Method	Purpose
Long-term Sampling	PZ-01 and PZ-02 and MW-45 through MW-54	Groundwater	VOCs	PZ-01 and PZ-02 once per week for the first month and monthly thereafter for 5 months. MW-45 through MW-54 monthly for 6 months	Laboratory	8260B (SW-486)	P1, S1
			Dissolved oxygen		In field	360.1 (MCAWW)	S2
			Redox potential		In field	2580B (APHA)	S2
			pH		In field	150.1 (MCAWW)	S2
			Specific conductivity		In field	120.1 (MCAWW)	S2
			Temperature		In field	170.1 (MCAWW)	S2
	A1 through A4	Air	VOCs	Once per week for the first month and monthly thereafter for 5 months	Laboratory	TO-14 (TOCAA)	P3, S4

Notes:

VOC Volatile organic compound

SVOC Semivolatile organic compound

P1 Primary Objective 1

S1 Secondary Objective 1

SW-846 Test Methods for Evaluating Solid Wastes (EPA 1994)

TOCAA Compendium of Methods for the Determination of Toxic Organic Compounds in Ambient Air (EPA 1984)

MCAWW Methods for Chemical Analysis of Water and Wastes (EPA 1983)

APHA American Public Health Association Standard Methods for the Examination of Water and Wastewater, 18th Edition, American Public Health Association, 1992

Long-term Sampling. Long-term sampling included the collection of groundwater samples for analysis of VOCs and select geochemical parameters and collection of air samples for analysis of VOCs. These samples were collected weekly for the first month of the demonstration and then monthly thereafter for 1 month. Data from these sampling events were used to evaluate the project objectives presented in Section 2.2. Each of these long-term sampling events is discussed below. Because of system operational difficulties during the evaluation, long-term sampling was limited to 6 weeks instead of the planned 6 month monitoring period. An overview of the sampling and analysis conducted for long-term sampling is shown in Table 2.

VOC Sampling. Groundwater samples were collected weekly during the first month of the demonstration from piezometers PZ-01 and PZ-02 and monthly thereafter for 1 month to evaluate the removal efficiency of the system. In addition, groundwater samples were collected from monitoring wells MW-45 through MW-54 during the first month of system operation to evaluate the change in contaminant concentrations within the treatment cell.

Select Geochemical Parameters Sampling. Dissolved oxygen, specific conductance, temperature, oxidation/reduction potentials, and pH were measured in the field in samples from piezometers PZ-01 and PZ-02 and monitoring wells MW-45 through MW-54 during each groundwater sampling event. The results of these analyses were used to evaluate changes in aquifer chemistry caused by the NoVOCs™ system.

Air Sampling. VOC concentrations were measured by collecting air samples from the influent and effluent of both the NoVOCs™ and Thermatrix systems from air sampling ports A1 through A4 using Summa canisters and analyzing the samples using EPA Method TO-14. Air flow rates were also measured. Air samples were collected from the sampling ports weekly during the first month of the evaluation (four events) and monthly thereafter for 1 month (one event). These data were used to evaluate the contaminant mass removal of the NoVOCs™ system and the effectiveness of the Thermatrix flameless oxidation process. Air sampling was terminated because of operational problems with the NoVOCs™ system.

Dye Trace Sampling. Baseline groundwater and carbon pack samples were collected from monitoring wells MW-45 through MW-54 to assess the presence of potential tracer interferences and to evaluate

fluorescent background levels. The baseline sampling events were conducted after the monitoring wells were installed and before system startup. The sampling events were conducted 1 week apart from one another. Samples collected during the baseline sampling events were analyzed to assess the presence of natural background fluorescence. Any background fluorescence identified was compared to the spectral characteristics of Fluorescein and Rhodamine WT to determine the potential degree of interference with dye detection. Because of intermittent operation of the NoVOCs™ system, the planned dye tracer study was not conducted. Therefore, no further dye trace sampling was conducted beyond the baseline sampling event.

2.3.2.2 Sampling and Measurement Locations

Groundwater samples were collected at 12 locations, and air samples were collected at four locations (see Figures 4 and 5). The analytical and field measurement parameters for each of these locations are provided in Table 2.

The four air monitoring locations are identified in Figure 4 as A1 through A4. Air samples were collected at sampling port A1, located immediately before air injection into the NoVOCs™ well, and sampling port A2, located immediately after air was extracted from the NoVOCs™ well. Air samples were also collected immediately before entering the Thermatrix flameless oxidations system at sampling port A3, and immediately after exiting the Thermatrix flameless oxidations system at sampling port A4. All air samples from system air sampling ports were monitored for VOCs. In addition, air flow rates were measured at sampling ports A1 and A2. Air sampling ports A2 and A3 are similar, except for their physical location in the treatment process and that air sampling port A3 is mixed with ambient air as necessary to maintain a consistent air flow rate into the Thermatrix system.

The two piezometers and 10 groundwater monitoring locations are identified on Figure 5 as piezometers PZ-01 and PZ-02 and monitoring wells MW-45 through MW-54. The two piezometers and five of the monitoring wells, as shown, are within the projected treatment cell and at the projected horizontal extent of the treatment cell. Five of the wells are just outside the projected treatment cell. Because well placement was based on the projected radius of the treatment cell of 90 feet, all wells were monitored during the demonstration.

2.3.3 Sampling Methods

This section describes the procedures for collecting representative groundwater and air samples and measuring air flow rate at each designated sampling location.

2.3.3.1 Groundwater Samples

Each monitoring well was equipped with a dedicated bladder pump that was used to collect groundwater samples. The bladder pumps were placed at the mid-screen interval in each monitoring well. A low-flow purge method was used to ensure that representative samples were collected. During purging, field parameters, including pH, temperature, and specific conductivity were measured at least once every 5 gallons. Once field parameters stabilized to within 10 percent of the previous measurement, samples were collected. Groundwater samples were collected by gently introducing water from the pump discharge line directly into prepreserved sample containers. Immediately after collection, groundwater samples were labeled and placed in a cooled ice chest for transport to the analytical laboratory. A similar procedure was used to collect groundwater samples from the two piezometers, except that a peristaltic pump with dedicated surgical tubing was used instead of dedicated bladder pumps.

2.3.3.2 Air Sampling

Duplicate, 1-hour integrated air samples were collected from each sampling location using Summa canisters equipped with flow meters. Each sampling event used new Teflon® tubing and stainless-steel connections. Duplicate samples were collected by installing union tees at each sample port and connecting the inlet tubes from the union tee to separate Summa canisters. A minimal length of Teflon® tubing was used for all connections. Once all connections were made and the Summa canisters were ready for sampling, the vacuum pressure in each Summa canister was measured using a pressure gauge and the reading recorded on the sample label. The Summa canister valve was then opened, and the canister was allowed to fill for a period of 1 hour. After the 1-hour period, the valve was closed, and the vacuum pressure was remeasured and recorded on the sample label. Immediately after collection, air samples were labeled and placed in a Summa canister shipping container for transport to the analytical laboratory.

For the collection of air samples from sample port A4, air samples were withdrawn from the stack gas through a condensate trap because of the very high moisture content. The trap was placed in an ice bath to condense and remove considerable liquids from the air stream during collection of the duplicate, 1-hour integrated air samples.

2.3.3.3 Air Flow Measurements

The volumetric flow rate at the influent and effluent air stream sampling ports (A1 and A2) was measured using in-line, orifice plates. The orifice plates used to determine air flow were 2-inch-diameter (influent line) and 3-inch-diameter (effluent line) orifice plates manufactured by Lamda Square, Inc. By measuring the drop in pressure across the orifice plate, the volumetric air flow rate was determined by plotting the pressure on certified flow curves. The pressure drop across the orifice plates was measured using a magnehelic gauge. The flow curves were certified by the manufacturer.

2.3.4 Analytical Methods

Groundwater and air samples were analyzed for the parameters outlined in the TEP/QAPP (Tetra Tech 1998) using the methods specified in Table 3. For the SITE evaluation, VOCs and air flow rate were considered to be critical parameters. VOC concentrations were determined using the gas chromatography/mass spectrometry Method 8260B capillary column technique. Because both matrices (groundwater and offgas) produced a vapor phase that was desorbed from a trap onto a gas chromatographic column, the analysis is the same. Compounds in the samples were detected and identified using the mass spectra produced as compared to the mass spectra from the initial calibration for each compound. The concentration of each compound was determined by comparison of the sample response to the daily continuing calibration response. Air flow rate was determined as described in Section 2.3.3.3. Noncritical parameters for the SITE evaluation were measured using the methods and procedures presented in Table 3.

2.3.5 Quality Assurance and Quality Control Program

QC checks and procedures were an integral part of the NoVOCs™ SITE evaluation to ensure that QA objectives were met. These checks and procedures focused on collection of representative samples

TABLE 3

**ANALYTICAL METHODS
NoVOCs™ SITE Demonstration
Site 9, NAS North Island, California**

Analysis	Matrix	Method	Reference
Volatile Organic Compounds	Groundwater	8260B	SW-846
	Air	TO-14/8260B	TOCAA/SW-846
Flow rate	Air	Oriface plate	Certified flow curves
Dissolved Metals	Groundwater	3010/6010B	SW-846
Total Dissolved Solids	Groundwater	160.1	MCAWW
Total Organic Carbon	Groundwater	9060	SW-846
Alkalinity	Groundwater	310.1	MCAWW
Dissolved Oxygen	Groundwater	360.1	MCAWW
Redox Potential	Groundwater	2580B	APHA
Specific Conductivity	Groundwater	120.1	MCAWW
Temperature	Groundwater	170.1	MCAWW
pH	Groundwater	150.1	MCAWW

Notes:

- SW-846 Test Methods for Evaluating Solid Wastes (EPA 1994)
 TOCAA Compendium of Methods for the Determination of Toxic Organic Compounds in Ambient Air (EPA 1984)
 EPA Methods for Chemical Analysis of Water and Wastes (EPA 1988)
 APHA American Public Health Association Standard Methods for the Examination of Water and Wastewater, 18th Edition, American Public Health Association, 1992
 MCAWW Methods for Chemical Analysis of Water and Wastes (EPA 1983)

without external contamination and on generation of comparable data. Two types of QC checks and procedures were conducted during the demonstration: (1) checks controlling field activities, such as sample collection and shipping; and (2) checks controlling laboratory activities, such as extraction and analysis. The results of the field QC checks are summarized in Volume VI, Appendix F.

2.3.5.1 Field Quality Control Checks

As a check on the quality of field activities, including sample collection, shipment, and handling, three types of field QC checks (field blanks, trip blanks, and equipment blanks) were collected. In general, these QC checks assessed potential field contamination of the samples and helped ensure that the degree to which the analytical data represent actual site conditions. Any QC results that failed acceptance criteria were reported to the project manager or QA manager as soon as possible, and corrective action was taken. If a field QC check sample exceeded the established criteria for any analytical parameter, analytical results for that parameter in all associated samples having the analyte concentration above the quantitation limit were flagged during post-laboratory validation.

2.3.5.2 Laboratory Quality Control Checks

Laboratory QC checks were designed to determine precision and accuracy of the analyses, to demonstrate the absence of interferences and contamination from glassware and reagents, and to ensure the comparability of data. Laboratory-based QC checks consisted of method blanks, matrix spikes/matrix spike duplicates, sample duplicates, surrogate spikes, blank spikes/blank spike duplicates, and other checks specified in the analytical methods. The laboratory also performed initial calibrations and continuing calibration checks according to the specified analytical methods. The results of the laboratory internal QC checks for critical parameters are summarized on a method-specific basis in Volumes II through V, Appendix D.

Routine QC was performed for the noncritical general chemistry parameters. At least one laboratory duplicate and check standard was run for every batch (minimum of one per 20 samples) for alkalinity and total dissolved solids. Laboratory blanks were also run for these parameters. Duplicate samples were run for all other noncritical analyses at a frequency of 10 percent or at least one per batch. The relative percentage difference (RPD) acceptance criteria for duplicate analyses was 20 percent. Additionally,

check standards and laboratory blank samples were run for metals analyses. The results of the laboratory internal QC checks for noncritical analyses are presented in Volumes II through V, Appendix D.

2.4 MODIFICATIONS TO THE TEST EVALUATION PLAN

Several modifications from the TEP/QAPP (Tetra Tech 1998) were made during the demonstration. To achieve the evaluation objectives, long-term sampling consisting of monthly sampling of groundwater and air for VOCs and weekly sampling of groundwater for fluorescent tracer dyes for six consecutive months was planned. However, long-term sampling was limited to the first month of the demonstration because of sporadic operation of the NoVOCs™ system at Site 9. In addition, the dye trace study was not conducted; no fluorescent dyes were injected into the aquifer. Because the dye tracer study was not conducted, primary objective P2 (determine the radius of the NoVOCs™ treatment cell) could not be evaluated. Instead, indirect methods consisting of a series of aquifer pump tests were used to indirectly evaluate the objective. Aquifer testing also provided additional information on the hydrogeologic characteristics of the site. A detailed description of the methods and procedures used to conduct the aquifer testing is presented in the Hydrogeological Investigation of the Aquifer Treated by the NoVOCs™ System (Tetra Tech 2000), which is provided as Volume I, Appendix C.

Several modifications to the sampling methods and procedures outlined in the TEP/QAPP were also made during the demonstration. During baseline sampling on April 17, 1998, monitoring wells MW-53 and MW-54 were not sampled because of a malfunctioning bladder pump in monitoring well MW-53 and the presence of the multi-level diffusion sampler in monitoring well MW-54. Oxidation/reduction potential readings were not collected during the baseline sampling event, first weekly event, second weekly event, third weekly event, and first monthly sampling events because of field sampling error. In addition, during the fourth weekly sampling event, piezometers PZ-01 and PZ-02 could not be sampled because of the presence of pH probes in the piezometers. Therefore, only air samples were collected during the fourth weekly sampling event. During the first weekly sampling event, air pressure, temperature, and flow rate from air sampling ports A1 and A2 were obtained from MACTEC flow meter readings at the wellhead and NoVOCs™ control trailer; flow readings using the orifice plate were not collected.

These deviations and modifications to the TEP/QAPP do not appear to have significantly affected the overall usability of the data collected. In addition, where appropriate, data have been flagged to qualify their usability. Although a full evaluation of the system was not possible because of the operational problems encountered during the demonstration, the limited data that were collected provide an indication of system performance during the first month of operation.

3.0 EVALUATION RESULTS

This section presents the operating conditions as well as the measurement results and associated data quality for the SITE evaluation of the NoVOCs™ technology. The evaluation results have been supplemented by information collected during the demonstration by Bechtel, Gilbert Hill Associates, Umtanum, and MACTEC.

3.1 OPERATING CONDITIONS

This section summarizes the configuration of the NoVOCs™ system, operating parameters, and system maintenance performed during the demonstration at Site 9. During the SITE demonstration, the NoVOCs™ system was operated at conditions determined by the vendor and SWDIV. To document the NoVOCs™ system operating conditions, groundwater influent and effluent and system process air stream were periodically monitored and sampled. The NoVOCs™ system was designed to operate continuously, 24 hours a day, 7 days a week; however during the demonstration, the system experienced significant operational difficulties.

3.1.1 NoVOCs™ and Thermatrix System Configurations

This section provides a description of the NoVOCs™ and Thermatrix system configurations.

3.1.1.1 NoVOCs™ System Configuration

The NoVOCs™ system installed at Site 9 consisted of an 8-inch-diameter, Schedule-80 polyvinyl chloride (PVC) casing with two screens; a 5-inch-diameter, Schedule 40 PVC eductor pipe to draw water from the contaminated zone; a 2-inch-diameter, Schedule 40 PVC airline with attached flow meter; a wellhead fixture with deflector plate; and associated seals and instrumentation components. The lithologic log generated during continuous coring of the NoVOCs™ borehole was used to locate the appropriate screen intervals. The A clay/silt layer was thought to be a possible hydraulic barrier; therefore, the NoVOCs™ well design was changed to accommodate a recharge zone located beneath the A clay/silt layer, and the extraction screen was installed above a cemented sandstone layer encountered at 78 feet bgs. An as-built diagram of the NoVOCs™ well is presented in Figures 10a through 10c.

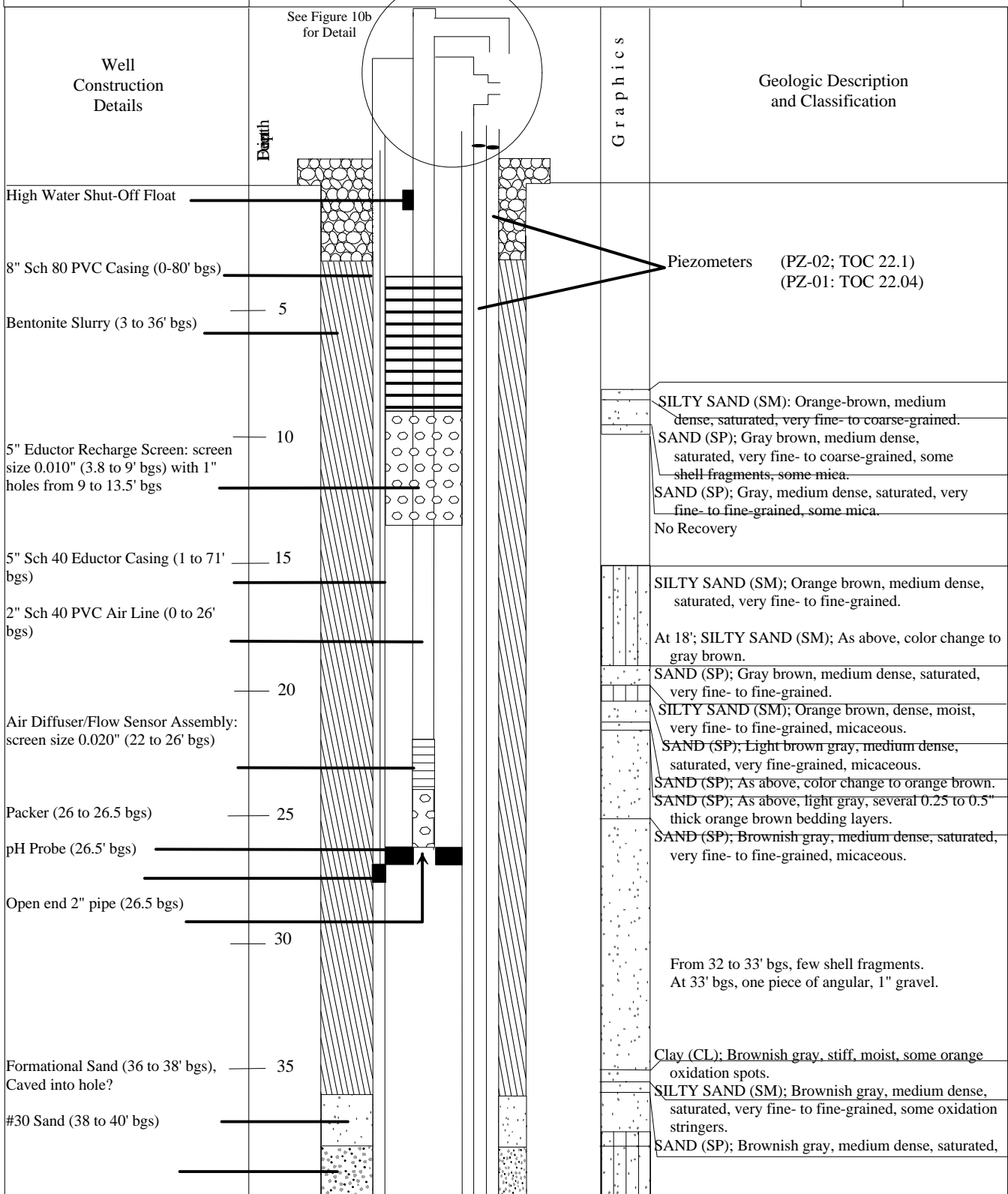

NoVOCs™ SITE Demonstration
Site 9, NAS North Island, California

FIGURE 10a
NoVOCs™ AS-BUILT DIAGRAM

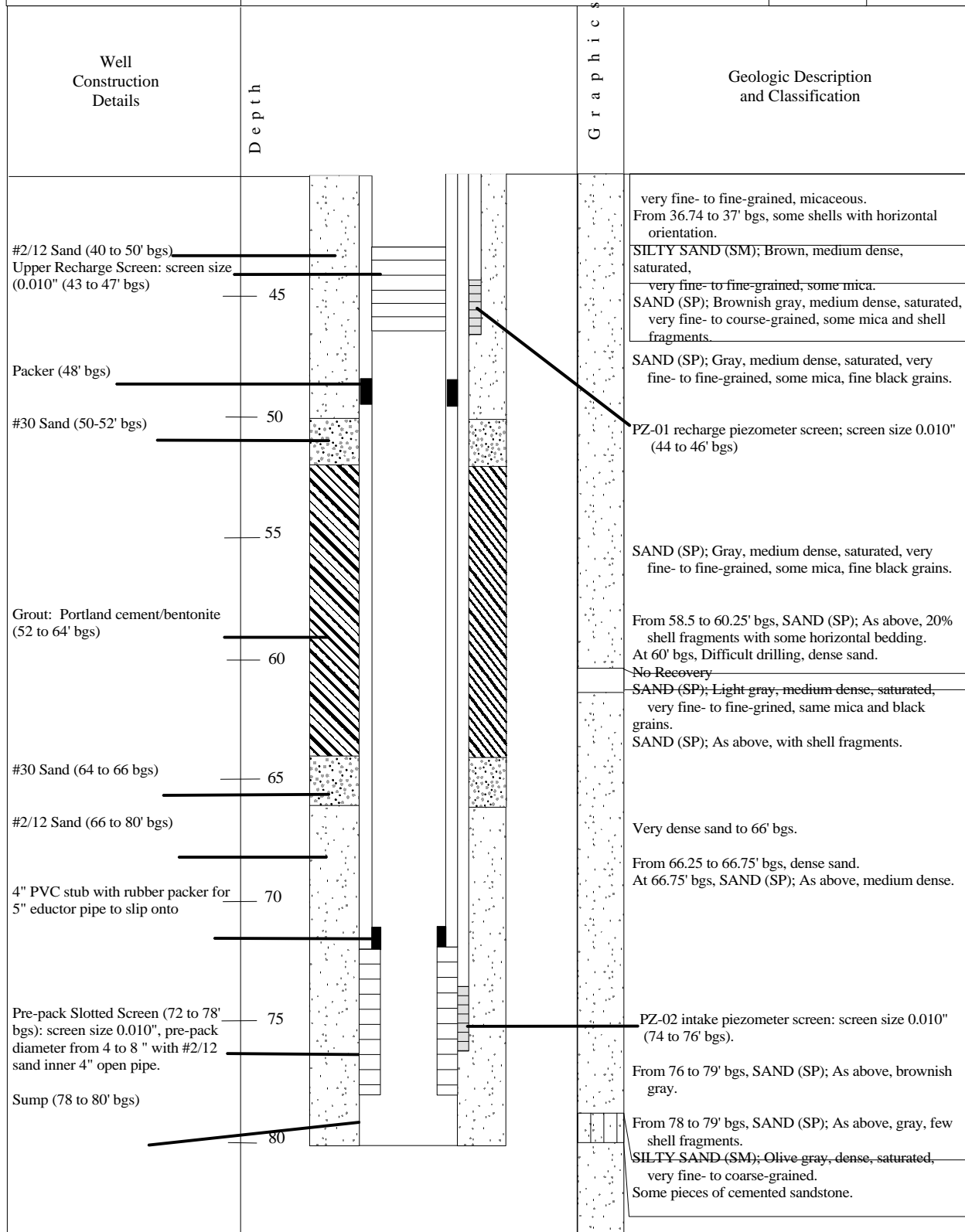

NoVOCs™ SITE Demonstration
Site 9, NAS North Island, California

FIGURE 10a (continued)
NoVOCs™ AS-BUILT DIAGRAM

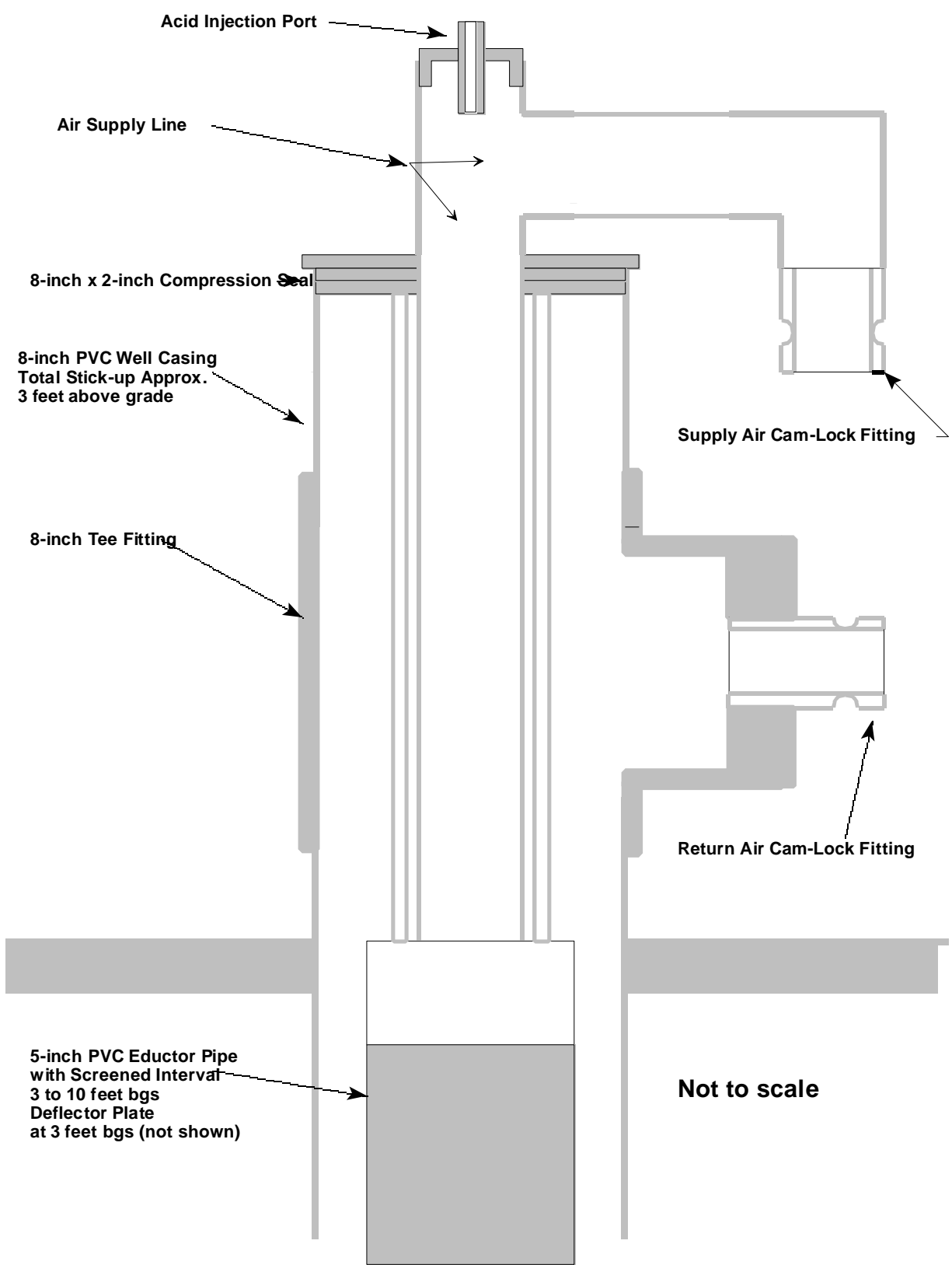

NoVOCs™ SITE Demonstration
 Site 9, NAS North Island, California

FIGURE 10b
WELL HEAD AS-BUILT DIAGRAM

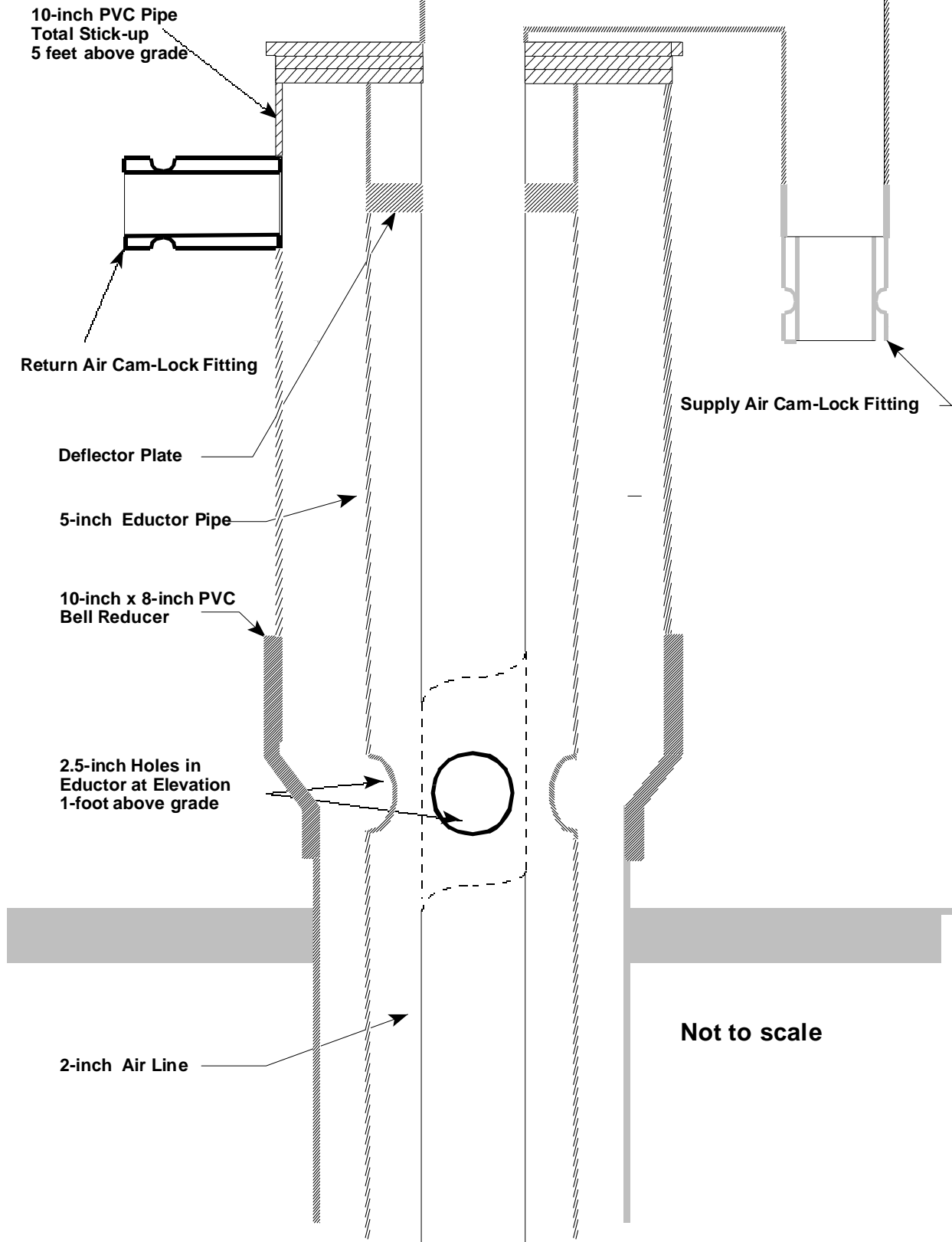

NoVOCs™ SITE Demonstration
Site 9, NAS North Island, California

FIGURE 10c
RECONFIGURED WELL HEAD
AS-BUILT DIAGRAM

The lower screen interval consisted of a prepack filter pack consisting of # 2/12 sand, an outside casing consisting of an 8-inch-diameter, Schedule 80 PVC, 10-slot screen (0.01 inch slots cut in the casing), and an inside casing consisting of a 4-inch-diameter, Schedule 40 PVC, 10-slot screen. The 4-inch-diameter inside casing extended above the prepack to provide a “stub” for the 5-inch-diameter eductor pipe to fit over, centralizing the bottom of the eductor pipe. The bottom of the lower interval screen was located at the top of the cemented sand layer at about 78 feet bgs, and extended from 72 to 78 feet bgs. The upper screen was 5 feet long and was located with its top below the silty sand layer at about 38 feet bgs, and extended from 43 to 47 feet bgs. The upper screen also consisted an 8-inch diameter, Schedule 80 PVC, 10-slot screen and a prepack filter pack of # 2/12 sand.

A 2-inch-diameter airline was used to inject air into the eductor pipe at a depth of about 10 feet below the static water table or about 27 feet bgs. The injection of air through the airline caused airlift pumping to occur within the well, drawing groundwater from the lower screen through the prepack filter, up the 4-inch PVC pipe, into the bottom of the 5-inch eductor, and up to the deflector plate located about 3 feet bgs. The deflector plate forced the water and air to pass through a series of 1-inch holes drilled near the top of the eductor pipe, causing separation of the water and air. The water was then allowed to fall into the annulus between the eductor pipe and the well casing and return to the aquifer through the upper well screen.

To measure the amount of groundwater being pumped by the NoVOCs™ system, a 1.5-inch orifice plate flow sensor was installed at the end of the air supply line. A pH electrode was also installed within the well annulus to measure pH levels in the upper recharge screen interval.

The aboveground components of the NoVOCs™ system consisted of a control trailer and an offgas treatment system. For the NoVOCs™ demonstration at Site 9, the Thermatrix flameless oxidation system was selected by SWDIV for treatment of the NoVOCs™ system offgas.

The major components of the NoVOCs™ control trailer consisted of the air injection blower, electrical control panel, and a Remote Telemetry Unit (RTU) programmable logic controller. The trailer also housed: (1) an inlet moisture separator; (2) a pump system to empty the moisture separator when the level reaches a high level; (3) an inlet filter; (4) an inlet air intake valve; (5) an inlet vacuum relief valve; (6) inlet and discharge pressure sensors; (7) an outlet temperature sensor; (8) an outlet high-pressure relief valve; and (9) air supply flow sensors (Clean Sites 1998).

The RTU provided local and remote (by telephone line) control of the blower. The blower could be started and stopped remotely, but none of the valves could be controlled remotely. The RTU was designed to shut down the NoVOCs™ system if: (1) blower discharge pressure was too high, (2) blower suction pressure was too low, (3) blower discharge temperature was too high, (4) the hydrochloric acid (HCl) drum level was too low, (5) the pH in the NoVOCs™ well was outside of operating range, (6) water levels in the NoVOCs™ well were too high, and (7) the Thermatrix treatment system was off line. The RTU also provided an indication of the cause of the shutdown. The off-normal pH shutdown feature was not provided in the original design, but was added in April 1998.

To address the operational problems experienced by the NoVOCs™ system, the configuration of the NoVOCs™ system was modified by MACTEC from August 25 through September 4, 1998. Using the aquifer pump test data collected earlier in the demonstration, MACTEC modified the configuration of the air diffuser assembly, deflector plate assembly, and the wellhead. The diameter of the wellhead was increased from 8 to 12 inches. The well was extended to a height of about 5 feet above ground surface. In addition, the deflector plate assembly was moved from below grade to about 3 feet above ground surface. The hole size in the eductor pipe air was also increased from 1 to 2.5-inches in diameter to allow more water to pass through the eductor pipe from the deflector plate. This modification was made to increase the amount of head in the NoVOCs™ well recharge water column. By increasing head more water could be injected into the aquifer. The hole size in the eductor pipe was also increased to 2.5-inches in diameter because only four holes were drilled to allow the air and water stream to exit the eductor pipe.

The NoVOCs™ wellhead was located in an area at SITE 9 that had received sand dredged from San Diego Bay, making it about 12 feet higher in elevation than the area immediately to the north. Support equipment, including the NoVOCs™ system control trailer and Thermatrix offgas treatment system was located about 300 feet northeast from the wellhead. The support equipment serviced the wellhead using one 2-inch PVC line for air supply, one 3-inch PVC line for air return, and various electrical and chemical services supplied through 0.75- and 1-inch PVC conduits. All services went under a road between the support equipment and the wellhead, and up the hill created by the fill from the bay. Figure 11a is a photograph of the wellhead looking toward downtown San Diego to the east. Figure 11b is a close up photograph of the NoVOCs™ wellhead. Figure 11c is a photograph of the service equipment taken from the elevated area and looking to the northeast. The trailer in Figure 11c contains a blower and moisture separator to supply air to the NoVOCs™ well and to process the return air. The skid-mounted equipment immediately behind the trailer is the Thermatrix offgas treatment system. The equipment behind the

Thermatrix skid and the areas of land covered by plastic are components of a soil vapor extraction system unrelated to the NoVOCs™ demonstration. The photographs in Figure 11a through 11c were taken in mid-May after modifying the NoVOCs™ system to include a pH shutdown system (see Section 3.1.3). Figure 11d shows the air line connections leaving the trailer in late February 1998 after the initial system installation.

3.1.1.2 Thermatrix Flameless Thermal Oxidation System Configuration

The offgas from the NoVOCs™ well was treated by the Thermatrix flameless oxidation system. The Thermatrix system is a patented process designed for treatment of air streams containing chlorinated VOCs. The Thermatrix system differs from conventional incineration and oxidation systems in that the oxidation of organics occurs in a bed of chemically inert ceramic materials without the presence of a flame.

The Thermatrix system used during the demonstration was a skid-mounted system that was located near the NoVOCs™ trailer. The VOC-laden offgas from the NoVOCs™ system was piped from the NoVOCs™ wellhead through the NoVOCs™ trailer to a knock-out pot to remove excess moisture prior to treatment by the Thermatrix oxidizer. A schematic diagram of the Thermatrix system is presented as Figure 12. The Thermatrix system was designed to treat up to 2,500 parts per million on a volume per volume basis (ppm v/v) of VOCs in air at a flow rate of 250 standard cubic feet per minute (scfm). The ratio of air and fuel added to the offgas mixture was controlled by internal sensors that regulated the gas flow rates and maintained the optimal treatment temperature. Propane was used as a supplementary fuel source by the Thermatrix system.

The oxidizer consists of a metal containment vessel with internal refractory linings and a ceramic matrix bed. As the gases pass through the ceramic matrix bed towards the reaction zone, they absorb heat, and



Photograph 11a: Service Equipment

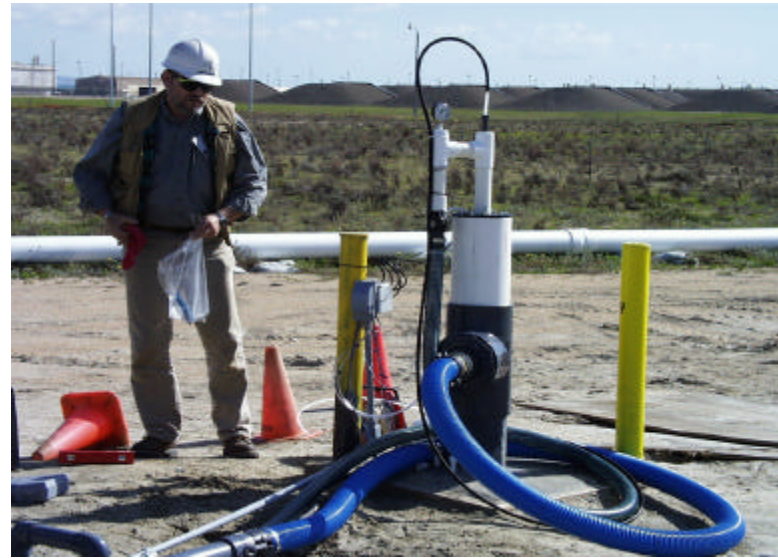

Photograph 11b: Wellhead



Photograph 11c: Control Trailer



Photograph 11d: Wellhead Area

NoVOCs™ SITE Demonstration
Site 9, NAS North Island, California

FIGURE 11
NoVOCs™ WELL PHOTOGRAPHS

 Tetra Tech EM Inc.

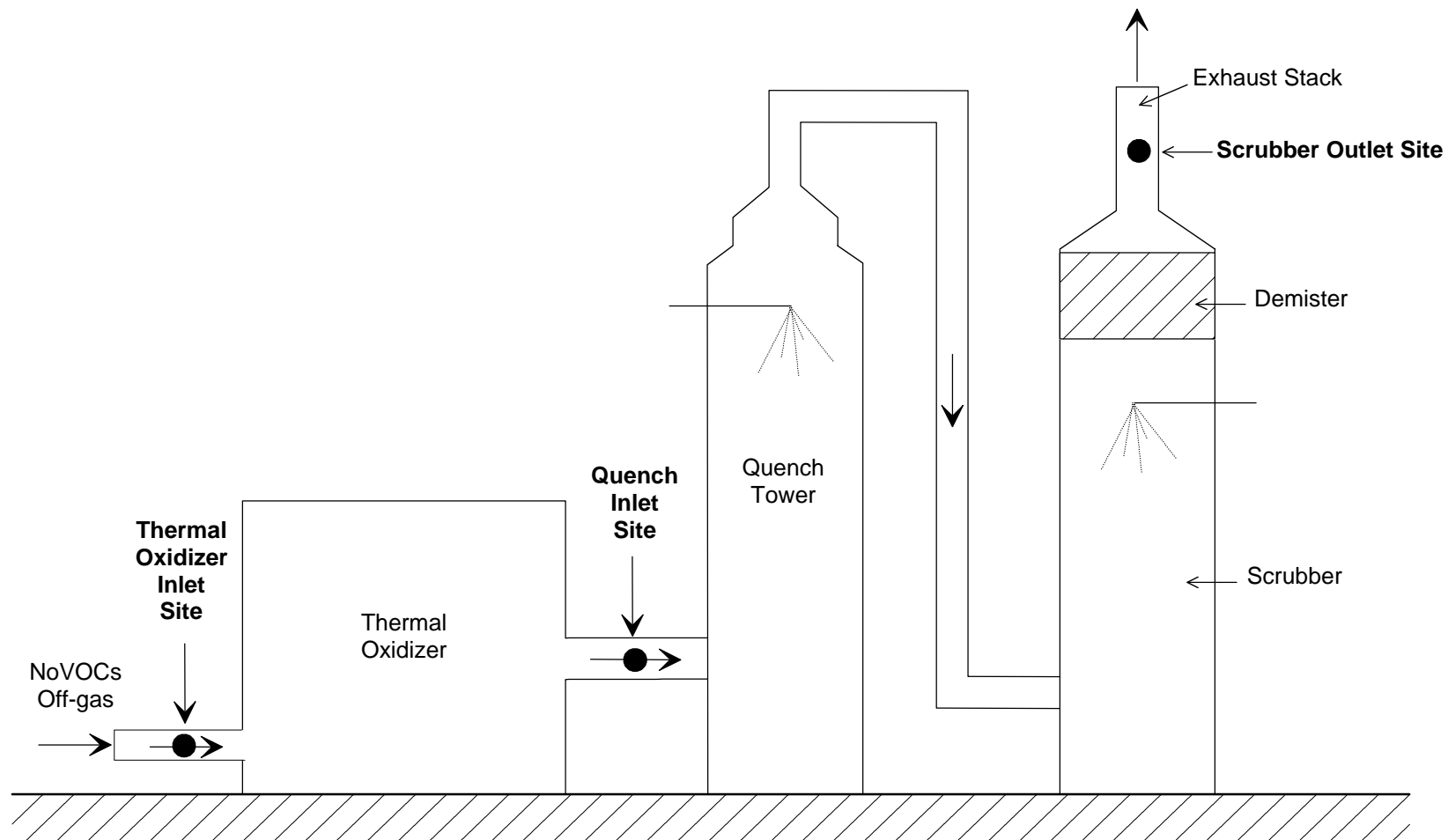

NoVOCs™ SITE Demonstration
 Site 9, NAS North Island, California

FIGURE 12
THERMATRIX FLAMELESS
OXIDATION SYSTEM

by the time they reach the reaction zone, the temperature reaches approximately 1,800 EF. At this temperature, thermal destruction and oxidation will occur, and the organic compounds in the air stream are converted to carbon dioxide (CO₂), water vapor, and HCl. The oxidation process is exothermic, and the released heat is reabsorbed by the ceramic matrix.

The processed gas stream exits the oxidizer through the bottom side of the unit. The flue gas leaving the oxidizer was expected to contain an average of about 4 lb/hr of HCl. A quench and scrubber system was incorporated into the Thermatrix design to remove 99 percent of the HCl before exhausting to the atmosphere. Blowdown water from this system was neutralized before being discharged to the sanitary sewer onsite.

3.1.2 NoVOCs™ Demonstration Operational Data Narrative

The NoVOCs™ system was monitored by Bechtel on a regular basis to evaluate its performance. System operating parameters monitored by Bechtel included blower suction, blower temperature, air flow rate, wellhead pressure, pumping rate, and pH in the groundwater discharged from the system. These parameters were documented in the field and recorded by the RTU. A summary of the operating parameter results measured during the demonstration is presented in Section 3.2.2.3. In addition, a system operation summary, documenting system operating time on a daily basis is graphically depicted in Figures 13a through 13c).

NoVOCs™ system operating conditions varied throughout the evaluation and can be generalized into four main operating periods: System Startup and Shakedown (February 26 through March 26, 1998), Early System Operation (April 20 through June 19, 1998), Reconfiguration Operation (September 24 through October 30, 1998), and Final Configuration Operation (December 4, 1998 through January 4, 1999).

The operating periods during the NoVOCs™ demonstration were conducted under varying configurations of the well internal components and various settings of operating parameters, such as supply air flow, pressure, and pH. Operations conducted in the later operating periods of the demonstration also included the addition of a biocide to control biological fouling of the well and two different chemical treatments to control iron fouling. The operating periods are shown graphically in Figure 13a through 13c. Selected

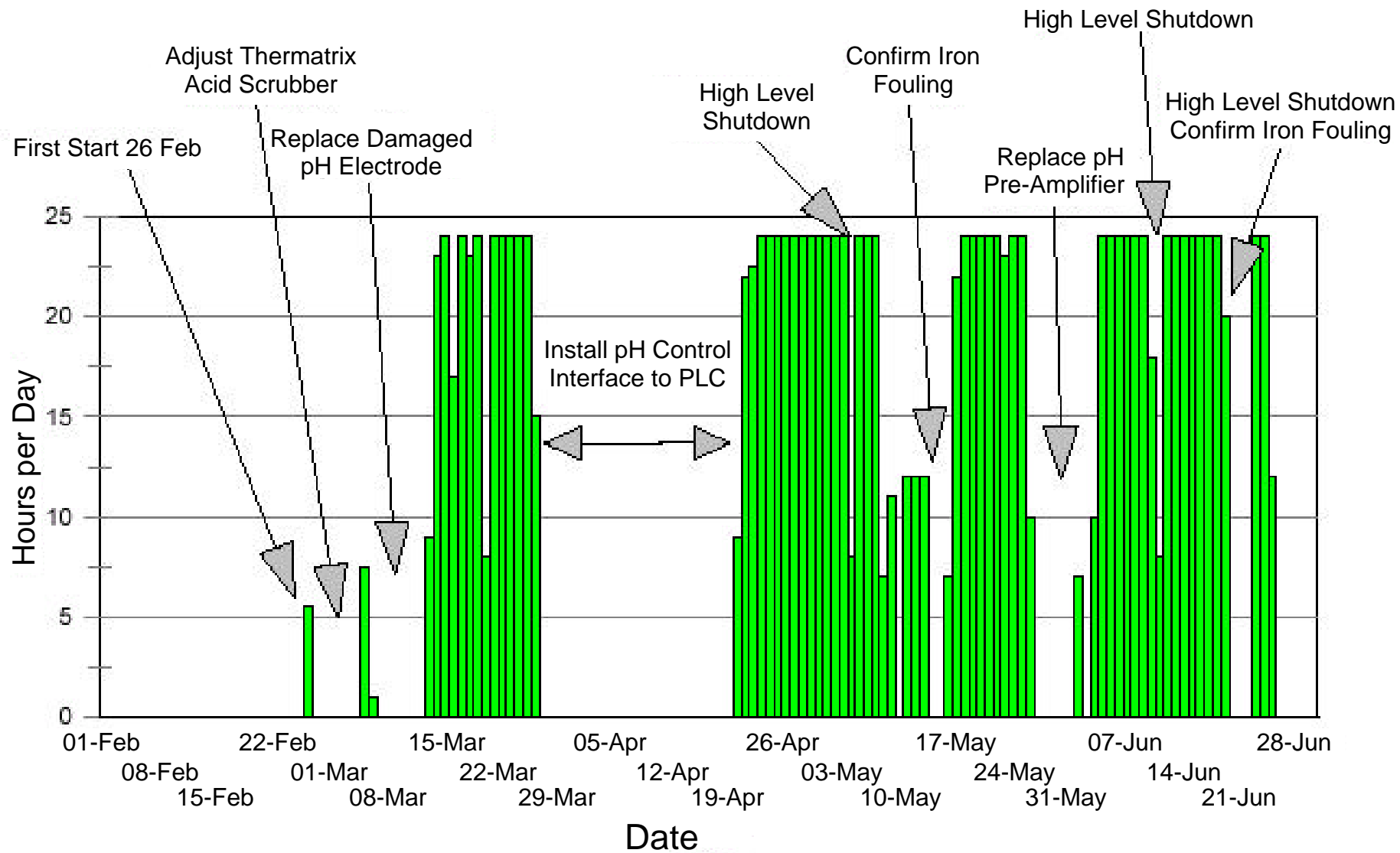

NoVOCs™ SITE Demonstration
 Site 9, NAS North Island, California
FIGURE 13a
NoVOCs™ SYSTEM BLOWER RUN TIME
Sheet 1

Source: Modified from Bechtel (1998)



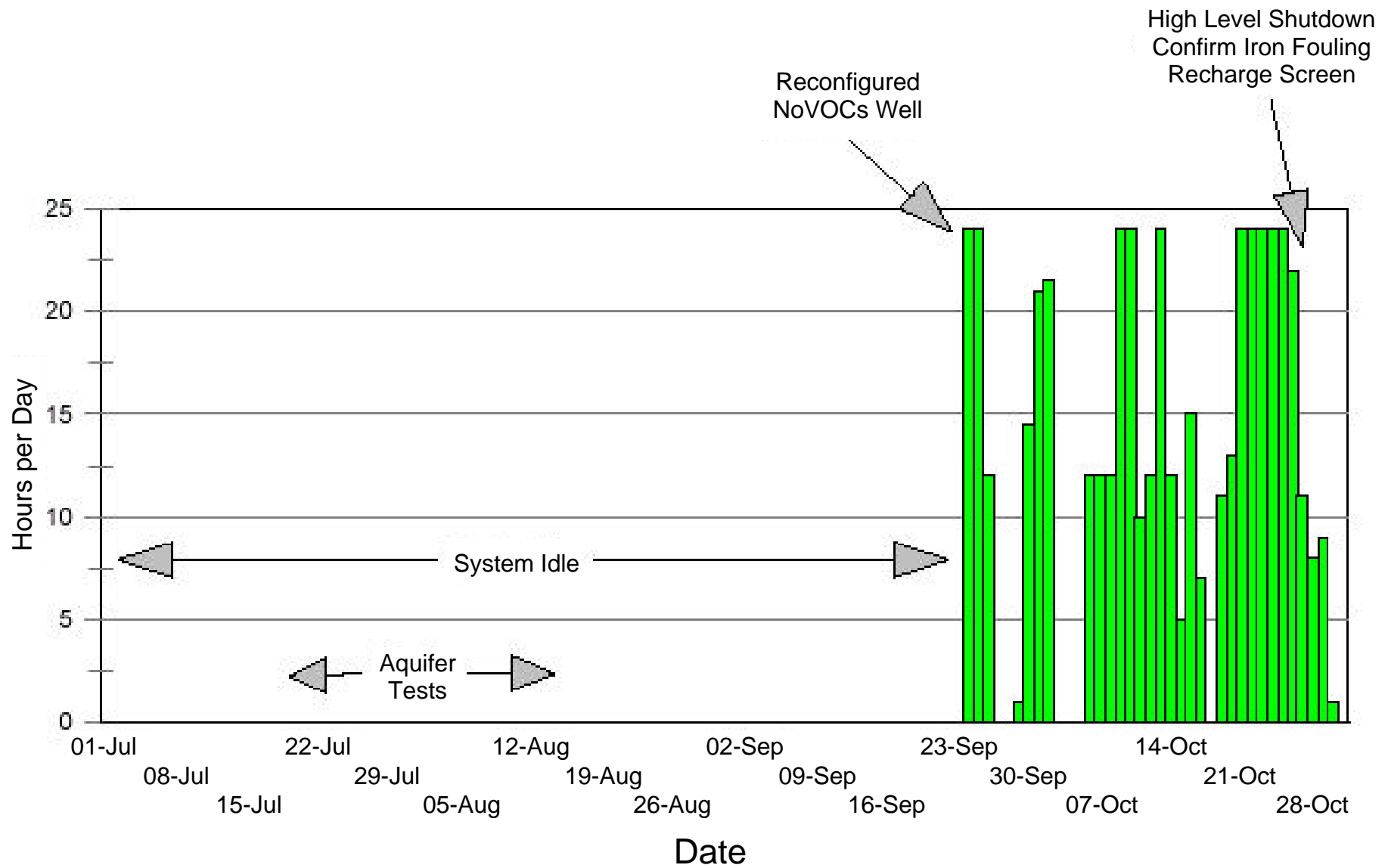

NoVOCs™ SITE Demonstration
 Site 9, NAS North Island, California

FIGURE 13b
NoVOCs™ SYSTEM BLOWER RUN TIME
Sheet 2

Source: Modified from Bechtel (1998)



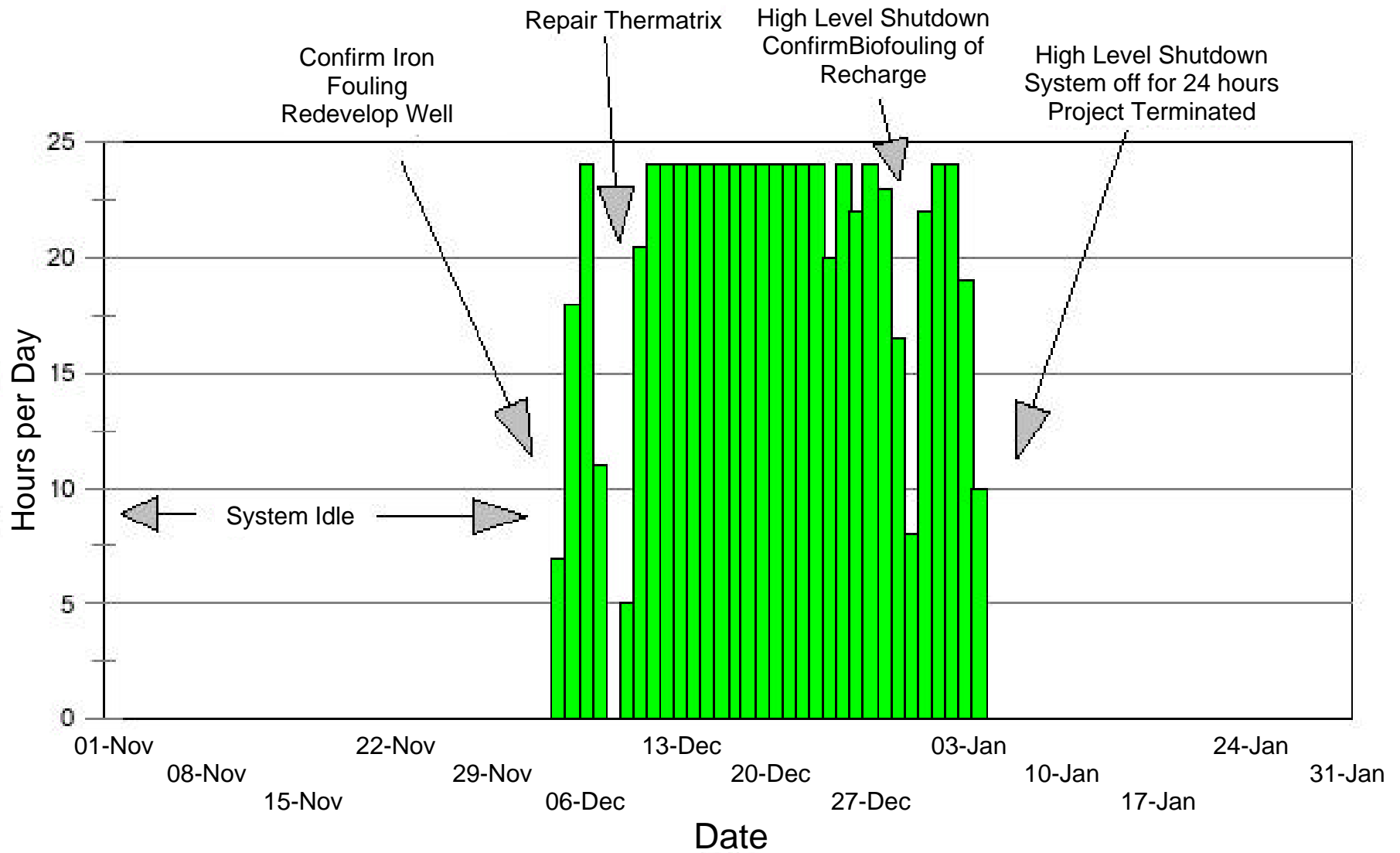

NoVOCs™ SITE Demonstration
 Site 9, NAS North Island, California

FIGURE 13c
NoVOCs™ SYSTEM BLOWER RUN TIME
Sheet 3

Source: Modified from Bechtel (1998)



pertinent operational parameters and mechanical configuration modifications affecting these periods are discussed in the following sections. Additional discussion of fouling as it applies to the NoVOCs™ installation at NAS North Island is presented in Section 3.1.3.

3.1.2.1 System Startup and Shakedown — February 26 through March 26, 1998

The NoVOCs™ system was installed in January and February 1998 and began operation on February 26, 1998, along with the Thermatrix offgas treatment system. Because the Thermatrix unit was unable to maintain effluent pH in an operable range, the NoVOCs™ system was only operated for about 6 hours on February 26, 1998. The brief startup operation was useful in determining the need to modify the preliminary configuration of the NoVOCs™ system. The preliminary design called for supply air flow of about 115 scfm. At this air flow, the wellhead was under constant positive pressure. The airlift pumping action of the NoVOCs™ system is very sensitive to back pressure. This means that a positive pressure in the wellhead will tend to reduce the pumping rate of the well. This situation was observed during the initial startup and is shown in Figure 14. Figure 14 indicates the values observed for blower flow in scfm, blower pressure measured in the air supply line at the wellhead (in inches of water), wellhead suction measured in the well casing at the wellhead (also in inches of water), and the indicated water pumping rate (in gallons per minute). In addition to the back pressure effect, at higher air flow rates, the water pumping rate will decrease with increasing air flow as the air-water flow regime changes from churn flow to annular flow. In the annular flow regime, the air stream occupies most of the volume of the pipe with water flow limited to a thin layer on the pipe walls.

The system began operation with a positive pressure of about 20 inches of water inside of the casing on the return air side of the system. This configuration produced an indicated pumping rate of about 15 gpm, which decreased to about 10 gpm as the supply air flow was reduced. The air flow was further reduced until the system registered a negative pressure at the return side of the wellhead, at which point the indicated pumping rate increased to over 20 gpm. The system was operated briefly on March 4 and 5, 1998; however, it was discovered that the submerged pH electrode inside of the NoVOCs™ well had shorted out and needed to be replaced. Replacement parts were procured and the system was started for shakedown operation on March 13, 1998. The system operated continuously until March 26, 1998, with only relatively brief shutdowns for inspection, flow balancing, and minor adjustments. During the shakedown period, the system was observed to operate normally with an average indicated pumping rate

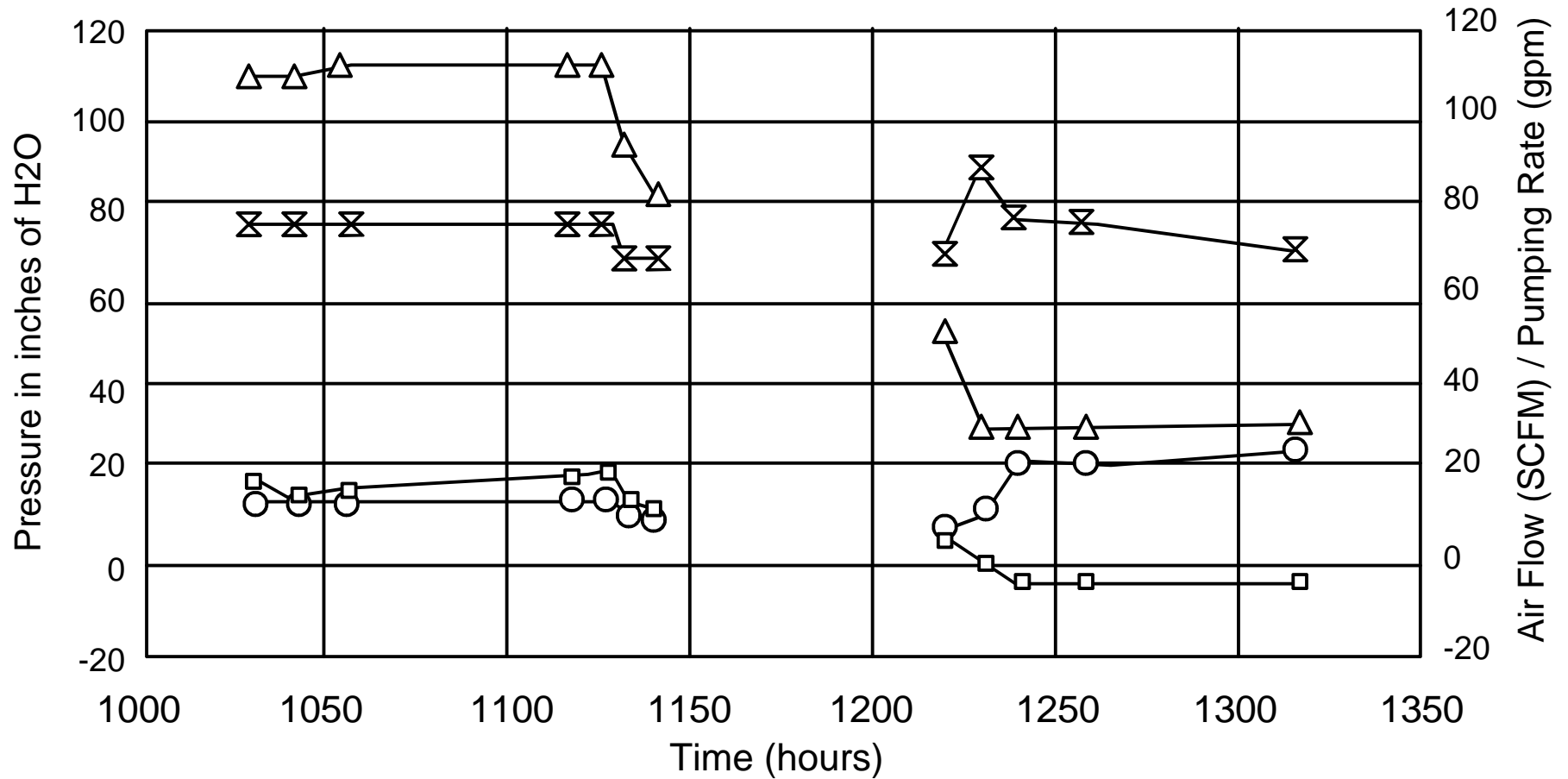

- △— Blower Flow
- ⊗— Well Head Pressure
- Well Head Suction
- Pumping Rate

NoVOCs™ SITE Demonstration
Site 9, NAS North Island, California

FIGURE 14
NoVOCs™ SYSTEM PRESSURE AND FLOW
MEASUREMENT - February 26, 1998

of 15 gpm and average air-to-water ratio of 30:1 (see Figure 15). It should be noted that prior to September 1998, many of the operating instruments on the NoVOCs™ system were direct-reading indicators, and data were not collected electronically. Many of the data collected during the initial operation of the system were, therefore, recorded by hand during operation and maintenance visits to the site.

The NoVOCs™ system was initially constructed with a pH control system that included an in-well submersible pH electrode, a pH signal pre-amplifier at the wellhead, a programmable proportional pH controller, and a proportional chemical metering pump. The pH control system was not configured for automatic shutdown in the event of a pH excursion. Such a shutdown was not part of the initial system design for the NoVOCs™ system demonstration or any other previous NoVOCs™ installation. pH control was maintained by adding metered amounts of 30 percent HCl to the air supply line at the wellhead during operation. The system was configured with interlock circuits to prevent system operation without a supply of acid in place.

The initial pH control objective was to maintain the pH of the treated water in the well at, or near, the pretreated groundwater pH of about 7.5. A preliminary air sparge and acid titration test was conducted on water from the site during preparation of the detailed design for the system. This test indicated that the air stripping action of the NoVOCs™ well would be expected to raise the pH of the water to approximately 8.3 after stripping. This pH rise, although not substantial compared to some highly alkaline waters of the western United States, was sufficient to raise a concern for calcite precipitation during system operation. The acid titration test was performed to support a preliminary estimate of acid consumption for pH control and for sizing the metering pump and other equipment. The results of the air sparging and acid titration tests are shown in Figures 16 and 17.

When the NoVOCs™ system was started on March 13, 1998, the pH control system indicated a wide range during the pH control cycle. The initial maximum pH was observed to be approximately pH 12.5 with a cyclical low of pH 6.95. This condition was observed for less than 24 hours from the startup and was attributed to the cycling of residual Portland cement from the bentonite-grout seal placed between the inlet and outlet screens of the NoVOCs™ well. The difference between observed pH cycles for selected periods on March 13, 1998, about 6 hours after startup, and on March 17, 1998, are shown in Figure 18. The high pH level was not observed again after the initial startup period.

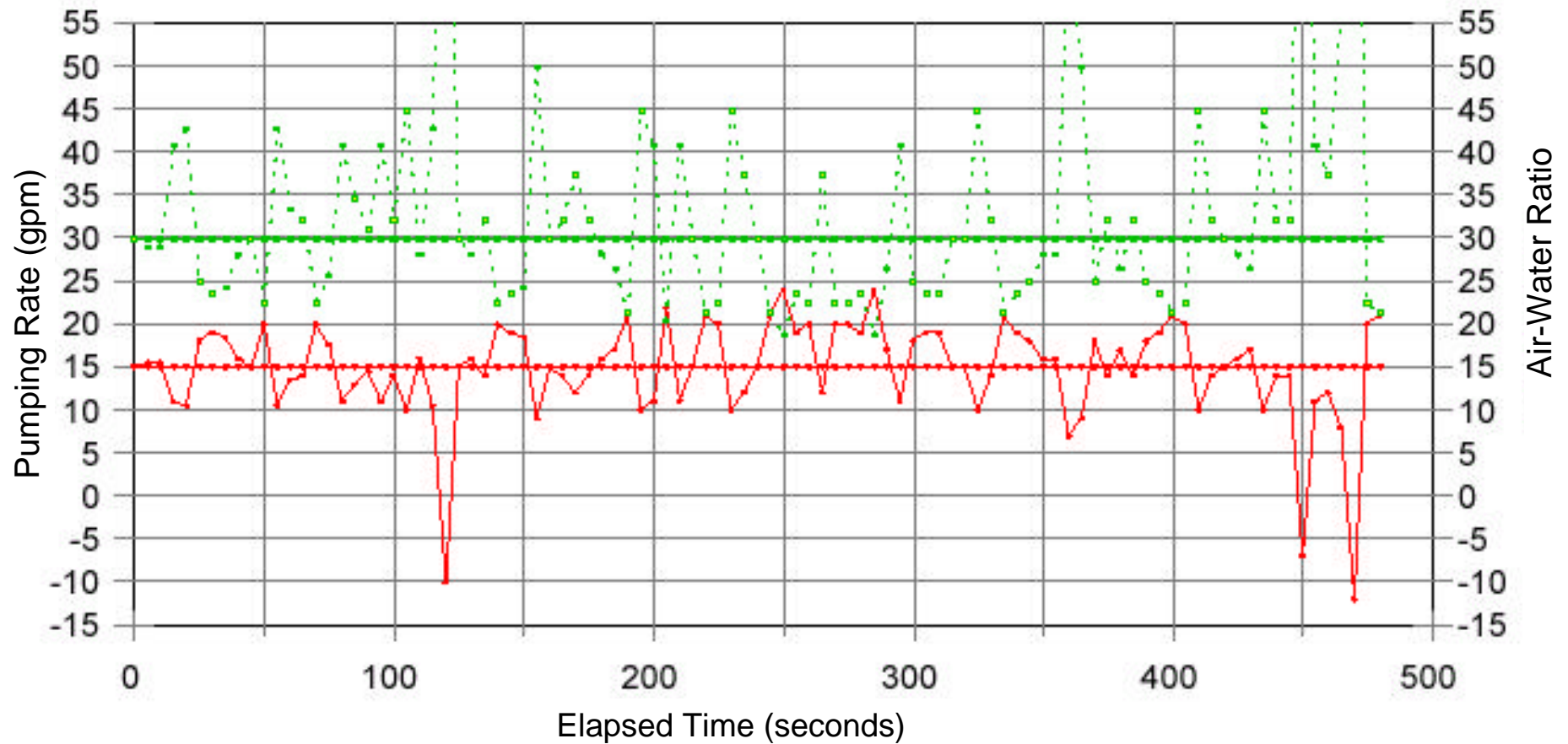

— Pumping Rate (gpm) — Air Water Ratio

gpm gallons per minute

NoVOCs™ SITE Demonstration
Site 9, NAS North Island, California

FIGURE 15
NoVOCs™ SYSTEM WELL PUMPING RATE
VERSUS AIR TO WATER RATIO - March 16, 1998

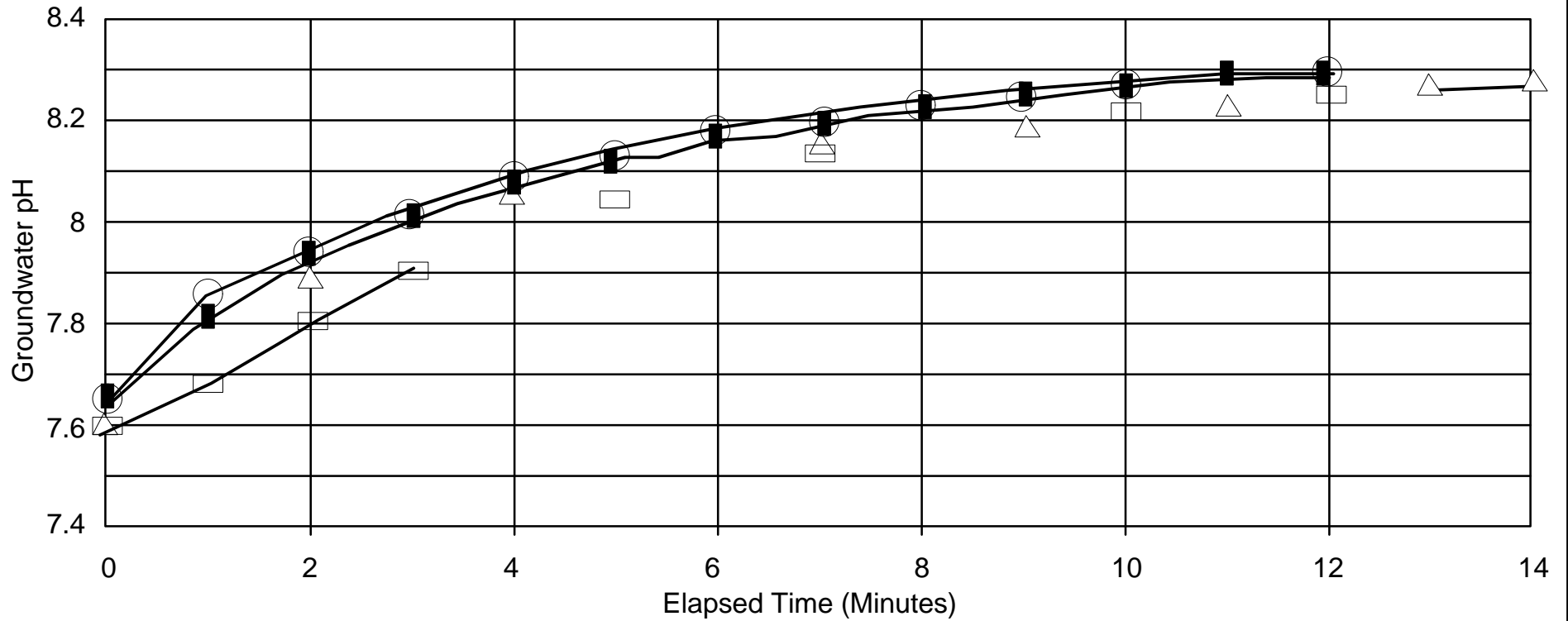

NoVOCs™ SITE Demonstration
 Site 9, NAS North Island, California

FIGURE 16
GROUNDWATER AIR SPARGING
pH RESULTS

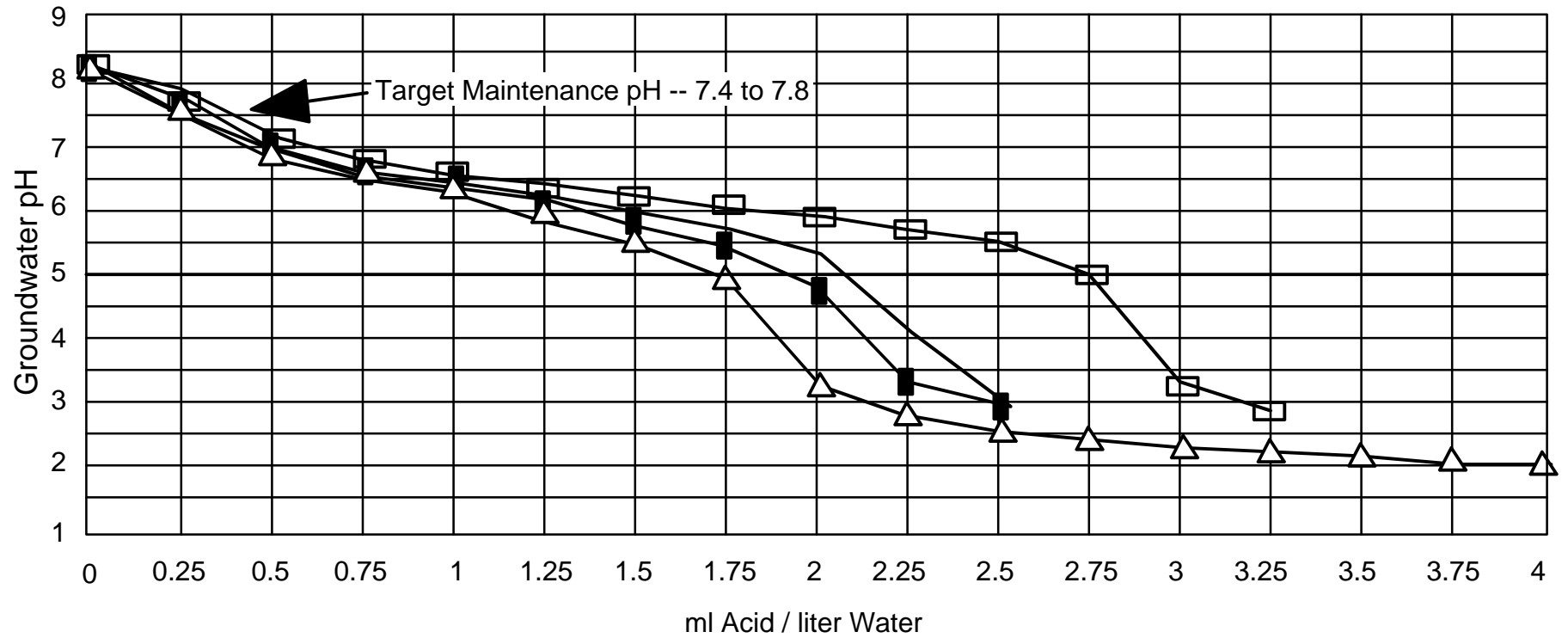

Sample 1
 Sample 2
 Sample 3
 Sample 4

NoVOCs™ SITE Demonstration
 Site 9, NAS North Island, California

FIGURE 17
TITRATION TEST RESULTS

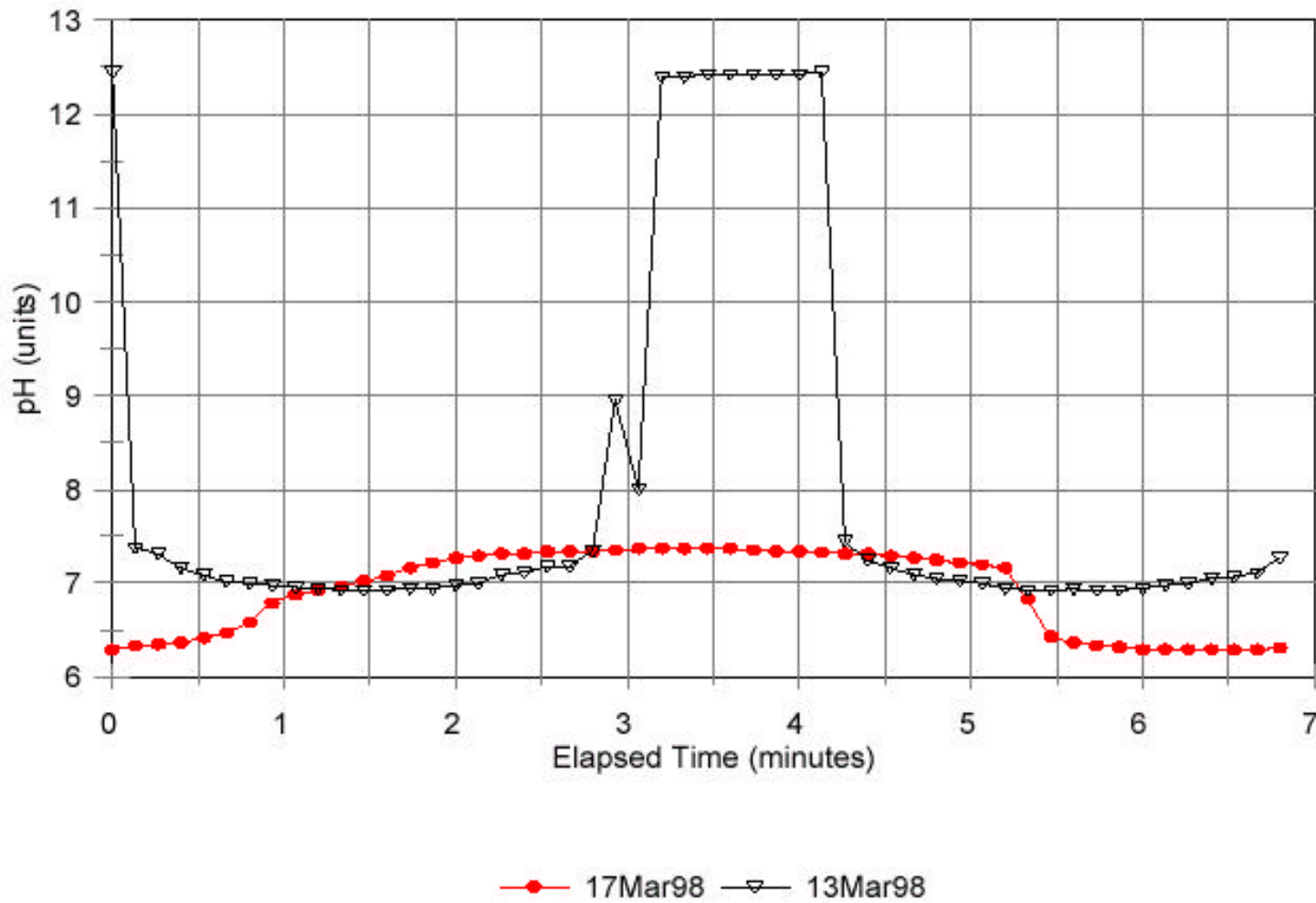

NoVOCs™ SITE Demonstration
 Site 9, NAS North Island, California

FIGURE 18
NoVOCs™ SYSTEM pH CYCLES
 March 13 and 17, 1998

 Tetra Tech EM Inc.

A demonstration kickoff meeting was held at NAS North Island on March 26, 1998, with all interested parties attending. Although the Navy indicated that the system was operating satisfactorily, MACTEC requested that the system be shut down because the pH controller did not send a shutdown signal to the logic controller. The system was idle between March 26 and April 20, 1998, while MACTEC modified the system controls to provide the pH shutdown feature.

3.1.2.2 Early System Operation — April 20 through June 19, 1998

The NoVOCs™ system was restarted on April 20, 1998, after installation of the additional hardware and software required to provide automatic system shutdown on pH excursion. The NoVOCs™ well internal components were removed for a brief inspection on April 20, 1998. At this time, the internal components displayed a very slight indication of ferric hydroxide deposition. The condition of the internal components of the well can be seen in Figure 19a. The system operated continuously until May 4, 1998, when the system exhibited a high water level shutdown. The NoVOCs™ well was initially designed and equipped with a float switch placed within the well casing at the approximate elevation of the ground surface. This switch was connected to the system logic controller to provide automatic shutdown of the system in the event a rising water level within the well threatened to allow free water to enter the return air plumbing. Free water entering the system through the return airline potentially could fill the return airline and the moisture separator on the NoVOCs™ blower system and require the removal of a substantial quantity of contaminated water from the system. The system was restarted shortly after the May 4, 1998, shutdown; however, the high water level condition was again observed on May 8 and 9, 1998.

Bechtel staff and subcontractors diagnosed the problem on May 13, 1998, by placing miniature transducer-data logger devices in the inlet and outlet piezometers of the NoVOCs™ well and within the annular space between the well casing and the eductor pipe. With these monitoring devices in place, the system was restarted and allowed to run until the high-level condition and automatic shutdown was observed. Figure 20 shows the relative water levels measured in the three locations. The plotted lines indicate the expected drawdown in the intake piezometer and anticipated rise in the recharge piezometer, both of which remained fairly stable during the diagnosis run. The water level in the annulus, however, started out substantially higher than that of the recharge piezometer and increased steadily until a high-level shutdown was induced (see Figure 20, time period 1600 hours to 2045 hours).



Photograph 19a: Well Air Unit



Photograph 19c: Well Internals



Photograph 19b: Well Educator Pipe



Photograph 19d: Biofouling Sample

NoVOCs™ SITE Demonstration
Site 9, NAS North Island, California

FIGURE 19
NoVOCs™ WELL INTERNALS
PHOTOGRAPHS

 Tetra Tech EM Inc.

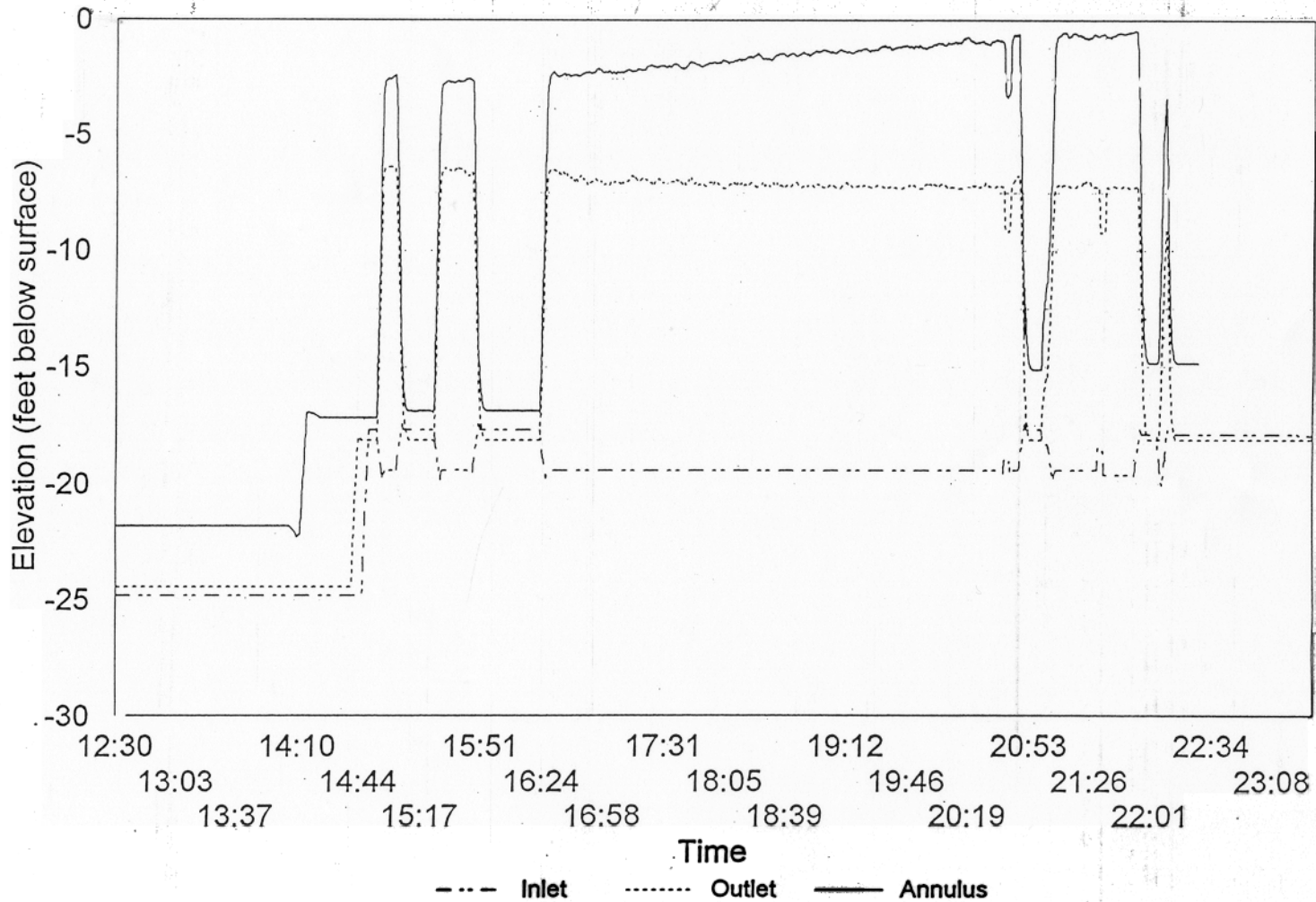

NoVOCs™ SITE Demonstration
 Site 9, NAS North Island, California

FIGURE 20
WATER LEVEL IN THE NoVOCs™ WELL
 May 13, 1998

 Tetra Tech EM Inc.

The fluid inside of the well annulus is a dynamic air-water mixture of varying content; therefore, the observed level in the annulus is expected to be somewhat higher than the dynamic water level in the recharge piezometer located within the filter pack outside of the well casing. The observed increase in the annulus level over the operating period shown in Figure 20, however, is not normal. The first high-level shutdown was observed at about 2045 hours. The system was then restarted, and another shutdown occurred within 10 minutes. These data indicated that the problem was indeed a condition of high level within the well, and the well was subsequently disassembled to examine the situation.

As well internals were removed from the well on May 14, 1998, the internal parts were found to be heavily coated with orange ferric hydroxide slime. Figure 19b shows the ferric hydroxide covering the airline and upper internal components. At the time the photograph in Figure 19b was taken, the ferric hydroxide was already substantially dehydrated. All of the internal components, including the 5-inch-diameter eductor pipe were removed from the well. The eductor pipe following removal from the well is shown in Figure 19c. The ferric hydroxide deposition was confined to the portions of the well that were either directly aerated during airlift pumping or where aerated water flowed through the well structure. All well internal components were cleaned with HCl to remove the iron precipitates prior the reinstallation in the well.

While the well internals were removed, the well was redeveloped on May 15 and 16, 1998. Well redevelopment consisted of bailing to remove a small amount of sand that had accumulated in the bottom of the well followed by pumping the lower screened interval at varying rates up to about 13 gpm. About 2,000 gallons of water were removed during redevelopment. The water from the lower screened interval was observed to be clear with measured turbidity of less than 5 nephelometric turbidity units (NTU). The submersible pump was removed from the well and an inflatable test plug was then placed in the well at an elevation below the recharge screen. The plug was inflated to isolate the upper screen from the lower screen, and the submersible pump was placed in the upper screen zone. The upper zone was pumped at varying rates, while the screened interval was simultaneously washed with a high-pressure water jet. After development, the water produced from the upper zone was also observed to be clear with turbidity less than 5 NTU. During well development, the upper zone (that is the recharge screen zone) displayed drawdown of 2 feet at 5 and 8 gpm, 3 feet at 13 gpm, and 8 feet at 50 gpm. The observed drawdown during development was not expected to represent a steady state condition because of the short duration of the pumping events.

The NoVOCs™ well was re-assembled and restarted on May 16, 1998. The system operated continuously with only brief stops for maintenance and sampling until May 26, 1998. At this time, the diagnosis of erratic pH indicated that the pH pre-amplifier was not functioning normally. Although the system was still operating at the time, it was shut down until a replacement pre-amplifier could be obtained and installed. The pre-amplifier was installed on June 1, 1998, and the system was restarted. A low pH shutdown was experienced after only a few hours of operation. The pH supply was adjusted and the airline submergence was reduced by about 1 foot (from 10.5 feet below static water level to 9.5 feet below static water level). The system was restarted on June 3, 1998. The system operated in this configuration at an indicated pumping rate of about 2 gpm until June 10, 1998, when the submergence was increased to 10.5 feet to increase the pumping rate. After a few hours of operation, the system again shut down because of a high water level within the well. The submergence was reduced to 9.5 feet below static water level again and the system was restarted. The system operated in this configuration until June 19, 1998, when a high water level in the well induced an automatic shutdown. Bechtel staff removed some readily accessible internal components from the well and again observed substantial accumulation of ferric hydroxide slime.

The system was operated continuously for 2 more days on June 24 through 26, 1998, but the need to implement some iron precipitation control was recognized. On June 27, 1998, the NoVOCs™ system was shut down for technical review and assessment of alternatives for precipitation control.

3.1.2.3 Aquifer Testing and System Modification — July through September 1998

After the system was shut down on June 27, 1998, MACTEC undertook a redesign and reconfiguration of the NoVOCs™ well internals. The design and fabrication of the new components took from July 1 through September 23, 1998. During this period, a series of aquifer pump tests at the site were conducted by EPA to provide additional information regarding hydrologic conditions at Site 9. The results of the aquifer tests are summarized in Section 3.2.2.5.

Down-hole Camera Survey. A down-hole camera survey of the NoVOCs™ well was conducted prior to redeveloping the well and performing the aquifer tests. The NoVOCs™ system had not been operated for a month before the down-hole camera survey and may not accurately reflect the condition of the operating well. The camera survey revealed the presence of biological fouling of the intake (lower) screen of the NoVOCs™ well in addition to large volumes of hydrated ferric hydroxide flocs. Because the upper

screen was scraped clean during removal of the internal well components, no visual indications of biofouling in the upper (recharge) screen were observed during the video survey. In reviewing the operating history of the NoVOCs™ well, it seems likely that biofouling, combined with the formation of hydrated ferric hydroxide from direct aeration of water in the well, contributed to the observed fouling of the recharge screen and subsequent high water level conditions observed. A sample of water from the well was submitted by Bechtel for bacteriological screening. The results of the screening confirmed the presence of a complex of microorganisms (see Section 3.1.3).

In addition to the traditional aquifer characteristics determined by the aquifer tests, two other important pieces of information were collected during the aquifer tests. These were confirmation of the recharge capacity of the upper screen of the NoVOCs™ well, and verification of calibration of the in-well orifice plate flow sensor.

Recharge Test. A recharge test of the upper (outlet) screen of the NoVOCs™ well confirmed that the outlet zone was capable of accepting water at a rate of 22.5 gpm with a standing water level in the well of about 2 feet below local grade and 25.0 gpm with a water level in the well at local grade. The water levels measured in the recharge piezometer during the recharge test are shown in Figure 21.

Down-hole Flow Sensor Test. The NoVOCs™ well initial design and construction included an in-well flow sensor consisting of a 1.5-inch-diameter orifice plate placed in a section of 2-inch-diameter pipe. This pipe section was fitted with a rubber seal and located inside of the eductor pipe below the air sparger in a configuration that routed the entire water flow within the eductor pipe through the flow sensor prior to aeration. The original system design included flexible pressure lines connected to radius taps above and below the orifice plate, extending upward through the well seal and outside of the wellhead. These pressure lines were connected to a solid state differential pressure transducer at the wellhead. The transducer received an excitation signal from, and transmitted a pressure signal to a digital panel meter located in the NoVOCs™ mechanical system trailer.

The panel meter was calibrated over a range of 0 to 40 inches of water differential pressure using the specific transducer at the well. The panel meter displayed the differential pressure across the orifice plate directly in units of inches of water differential. The indicated differential pressure was converted to an

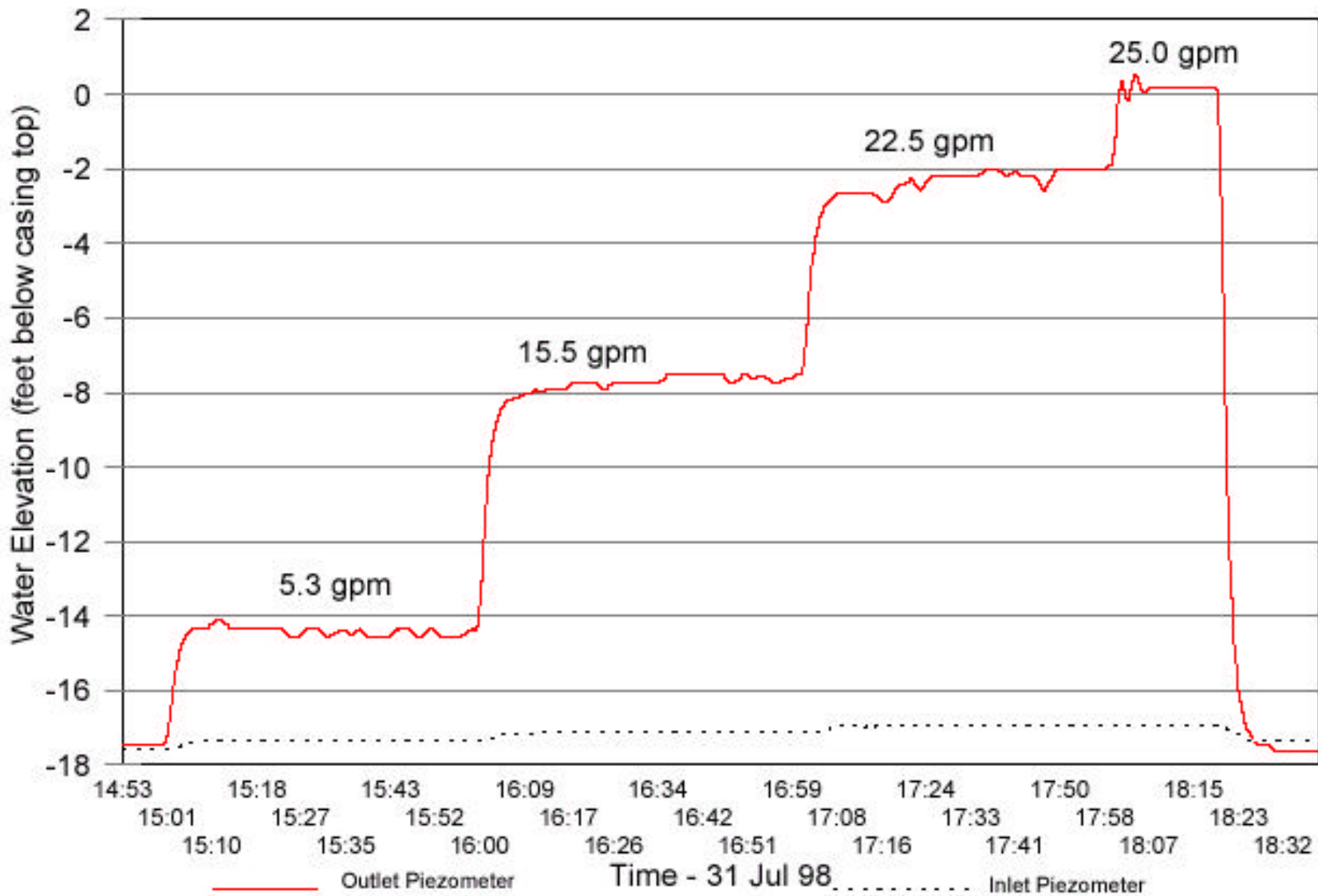

NoVOCs™ SITE Demonstration
 Site 9, NAS North Island, California

FIGURE 21
NoVOCs™ WELL
RECHARGE TEST RESULTS

in-well flow rate in gpm using a calibration curve derived for this specific orifice plate configuration. This system initially appeared to provide satisfactory indication of the NoVOCs™ well pumping rate; however, the system did exhibit short-term cyclical variation (over periods of minutes) and substantial drift over a period of hours to days. Some of the drift was attributed to leaks in the pressure lines from the taps to the transducer. This cyclical and variable behavior lessened confidence in the flow indication.

During the aquifer pumping tests with the well internals removed, Bechtel subcontractors attached the flow sensor to the end of the submersible pump discharge pipe and measured the indicated differential pressure across the orifice plate. The differential pressure was measured using an analog differential pressure gauge. The differential pressure across the orifice plate was observed and recorded at two known, measured constant water flow rates. The results of the flow sensor check are shown in Figure 22. At a known pumping rate of 20 gpm, the flow sensor indicated a differential pressure ranging from 3 to 5 inches of water, corresponding to an indicated flow rate of about 17 to 21 gpm. At a known pumping rate of 30 gpm, the flow sensor indicated a differential pressure ranging from 9 to 11 inches of water, corresponding to an indicated flow rate of 29 to 32 gpm.

The existing flow sensor was re-installed as part of MACTEC's redesign activities. The pressure tap lines, however, were subsequently connected to an uncalibrated transducer scaled from 0 to 150 inches of water with output to a data logger. The operating pressure range of the orifice plate was within the noise level of this transducer configuration. Subsequent measurements of differential pressure across the orifice plate confirming the cyclical nature of indicated flow rate were made in December 1998 and January 1999 using a calibrated pressure data logger (see Section 3.1.2.5).

NoVOCs™ Well Redesign and Configuration. During this period, MACTEC assembled modified components for installation in the well after completion of the aquifer tests. Because of the presence of biofouling organisms in the well, MACTEC included a system to inject a biocide in the well re-configuration. Two commercial chemical amendments manufactured by Betzdearborn Inc., were selected by MACTEC for addition to the NoVOCs™ system:

1. **Depositrol PY 505, a hydroxylated copolymer dispersant.** The purpose of Depositrol PY 505 is to prevent flocculation and maintain the colloidal state of ferric hydroxide molecules formed by direct aeration of ferrous iron in the groundwater. This material was

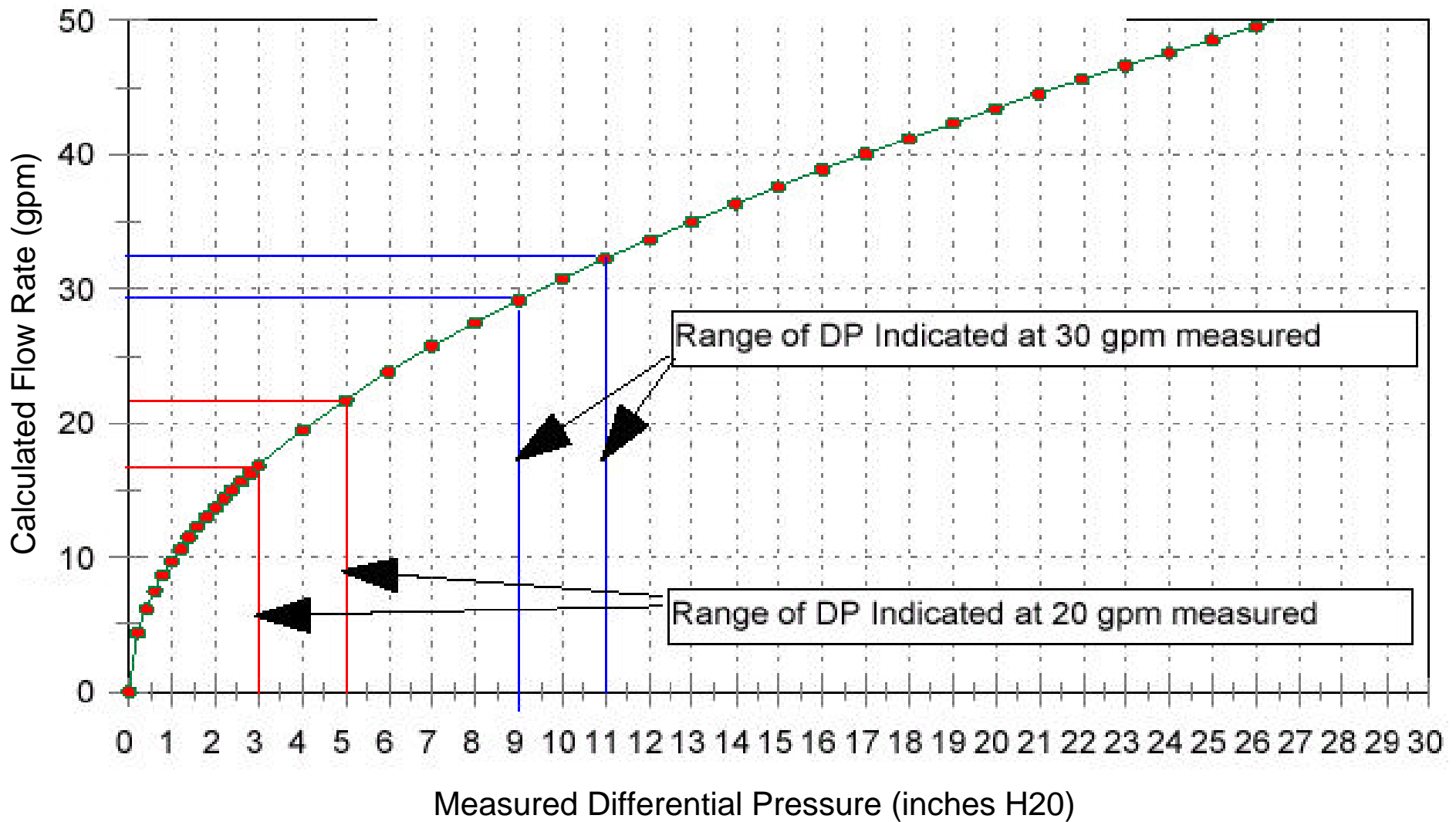

—●— DP (inches H2O)

DP Differential Pressure
gpm gallons per minute

NoVOCs™ SITE Demonstration Site 9, NAS North Island, California
FIGURE 22 ORIFICE PLATE FLOW SENSOR CALIBRATION CURVE
 Tetra Tech EM Inc.

to be delivered by a metering pump into the NoVOCs™ well at a depth below the air sparger to allow mixing in the well casing. The manufacturer's recommended application rate for Depositrol PY 505 was 15 parts per million (ppm) or 0.1 pounds of product per 1,000 gallons of water treated.

2. **ENTECH 367, a broad spectrum bromine/chlorine microbiocide.** The primary active ingredient of ENTECH 367 is 1-bromo-3-chloro-5,5-dimethylhydantoin. This material was to be delivered by a timed metering pump to the filter pack outside of the intake screen of the NoVOCs™ well through a tube inserted into the intake piezometer. The manufacturer's recommended application rate for ENTECH 367 was 12 ppm for a period of 6 hours per day.

Additional modifications made to the NoVOCs™ well are depicted in Figure 10c and are summarized below:

- C The eductor pipe water discharge point was raised to grade elevation.
- C The wellhead casing was extended to about 5 feet above grade elevation using 12-inch-diameter, Schedule 40 PVC pipe.
- C Chemical amendment addition lines were added to permit injection of the pH adjustment and iron dispersant chemicals below the air sparger.
- C One additional pressure tap line was added to allow monitoring of the level of the air-water mixture in the well annulus between the well casing and the eductor pipe.

Configuration of the well for addition of the microbiocide and iron dispersant required placement of additional chemical supply drums and metering pumps. The existing acid metering system and the two new metering systems were relocated from the mechanical system trailer site to the vicinity of the NoVOCs™ wellhead. This required extension of line power to a new service panel near the wellhead.

MACTEC installed an enhanced programmable logic controller to support the new metering systems and to resolve some operational difficulties experienced with the initial system logic controller during early operation. This new controller included multi-channel data logging capability and remote monitoring and data download. The new controller and software performed admirably for the duration of the demonstration period.

3.1.2.4 NoVOCs™ Well Operation after Reconfiguration — September 24 through October 30, 1998

On September 24, 1998, the reconfigured NoVOCs™ system was started. Some initial problems were encountered with restarting the Thermatrix unit after the 3-month period of nonoperation. MACTEC personnel operated the NoVOCs™ system under various conditions during this period to attempt to maximize the pumping rate in the well. The operation of the system from September 24 to October 30, 1998, was interrupted on numerous occasions by high water level conditions in the NoVOCs™ well and on four occasions by off-normal conditions in the Thermatrix unit. During this time, the precipitation control amendment was added to the system, and the microbiocide was added to the well at varying rates.

On October 27, 1998, the NoVOCs™ system was shut down because of a rising water level in the well. Accessible internal components were removed and observed to be coated with hydrated ferric hydroxide slime. Bechtel staff concluded that the well was again exhibiting fouling of the recharge screen. The system was operated again for brief periods from October 28 through 30, 1998, during which the system experienced repeated high water level shutdowns. MACTEC decided to discontinue their participation in the demonstration, and the system was idle from October 30 through December 4, 1998.

3.1.2.5 Final Configuration and Operation — December 4, 1998 through January 4, 1999

The Navy decided to make a final attempt to operate the NoVOCs™ system at Site 9. Bechtel staff and subcontractors developed a system restart strategy and evaluated the system. The well internals were inspected and found to be heavily fouled by ferric hydroxide precipitation. Based on observations by Bechtel staff of a brief response of decreased water level in the NoVOCs™ well following addition of a small quantity of additional HCl during the October 1998 operation period, Bechtel staff and subcontractors decided to attempt a chemical development of the NoVOCs™ well.

Well Evaluation and Testing. Bechtel subcontractors conducted bench tests during June and November 1998 on the effectiveness of citric acid in controlling ferric hydroxide precipitation following aeration of groundwater from Site 9. The bench tests indicated that citric acid could be very effective in controlling iron precipitation as well as providing the required pH control for the NoVOCs™ process. An example of the action of citric acid solution on the dissolved iron content of a groundwater sample from Site 9 is shown in Figure 23. This figure shows the results of three analyses of dissolved iron in a water sample.

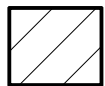
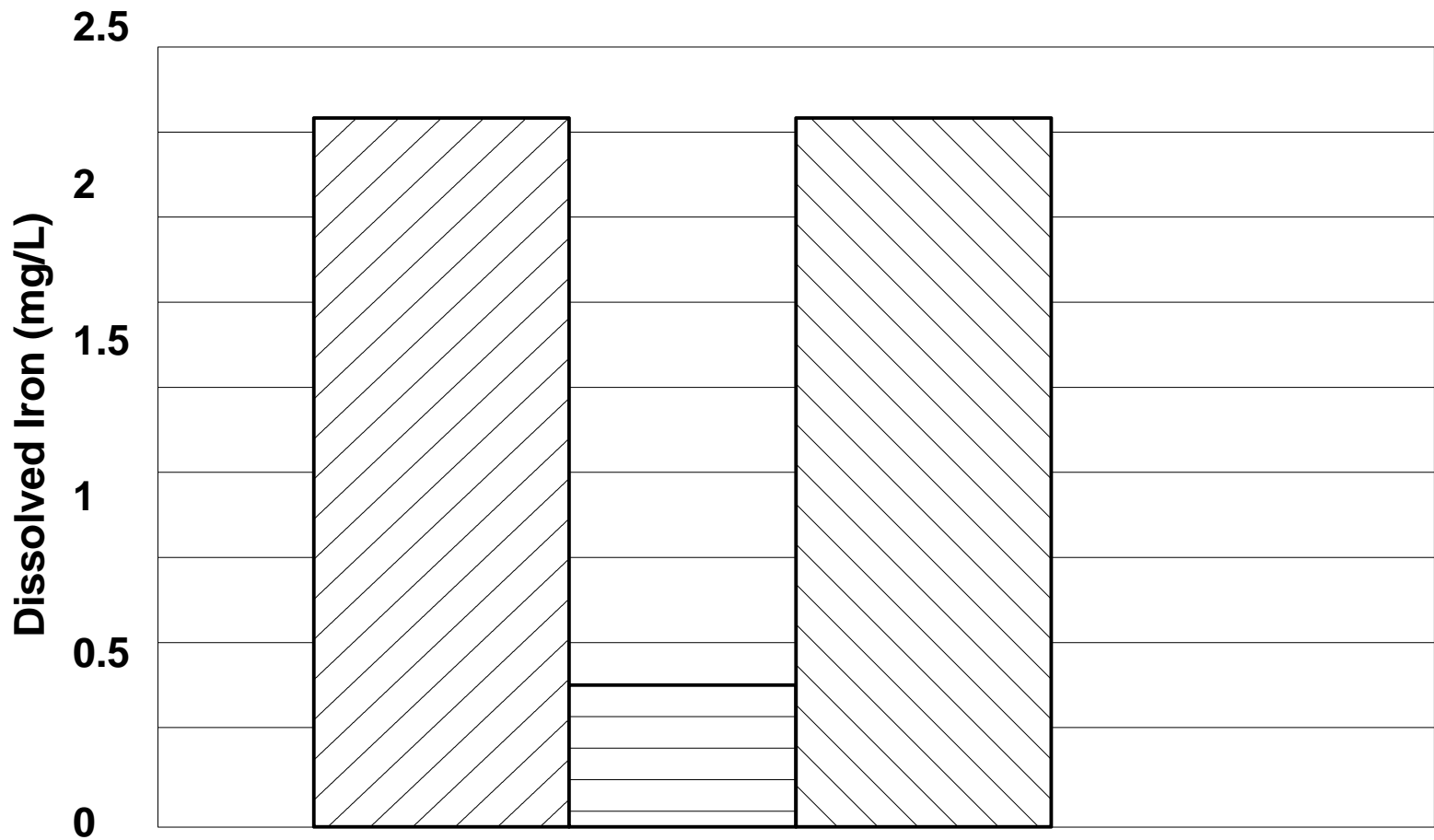

As Received



After Sparging

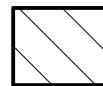

After Citric Acid Addition

NoVOCs™ SITE Demonstration
Site 9, NAS North Island, California

FIGURE 23
IRON PRECIPITATION TEST RESULTS



Tetra Tech EM Inc.

The first analysis is the as-received content of dissolved iron (2.2 milligrams per liter [mg/L]). The water sample was then aerated in an open beaker using an air pump, tubing, and an air stone. After aeration, visible ferric hydroxide flocs were seen in the beaker. A decanted supernatant sample contained only 0.42 mg/L of dissolved iron. The same aerated sample was then treated with citric acid solution and retested, indicating that the dissolved iron content in the sample was once again at the pre-aeration concentration of 2.2 mg/L.

Before final configuration operation, the precipitation control system was modified for addition of 20 percent citric acid solution because the commercial Depositrol PY 505 had been shown to not provide satisfactory iron precipitation control at the added rate. In addition, the NoVOCs™ well was injected with about 5 gallons of HCl. This solution was agitated in the well casing and allowed to sit for several hours before testing its effect on the well.

On December 2, 1998, a recharge test was conducted on the NoVOCs™ well. This test was conducted by adding water to the well annulus and measuring the recharge elevation height in the recharge piezometer. The results of the test are displayed graphically in Figure 24. Water was added to the well annulus at a constant rate of 6.4 gpm. The water level quickly increased to a level substantially above the level expected for that recharge rate, based on the recharge rate versus recharge head observed during tests in July 1998. The water level continued to rise gradually during the test, indicating reduced recharge capacity. After about 2 hours of recharging the well at 6.4 gpm, 20 pounds of crystalline citric acid were added directly to the well annulus. After another 30 minutes of recharging, the water addition was stopped and the water recharge rate was observed.

Measurement of the well recharge rate after citric acid treatment indicated that the recharge rate had improved, apparently through dissolution of ferric hydroxide precipitates within the well. The recharge portion of the test curve shown in Figure 24 displays characteristics very similar to the recharge portion of the test curve from July 31, 1998 (see Figure 21). This test indicated that the treatment was sufficiently effective to consider starting the NoVOCs™ system using citric acid for iron precipitation control.

NoVOCs™ System Reassembly and Restart. The NoVOCs™ well was reassembled on December 3 and 4, 1998. The in-well flow sensor was connected to an analog differential pressure gauge for direct reading. The high-level float switch was re-installed within the well casing, and the system was restarted

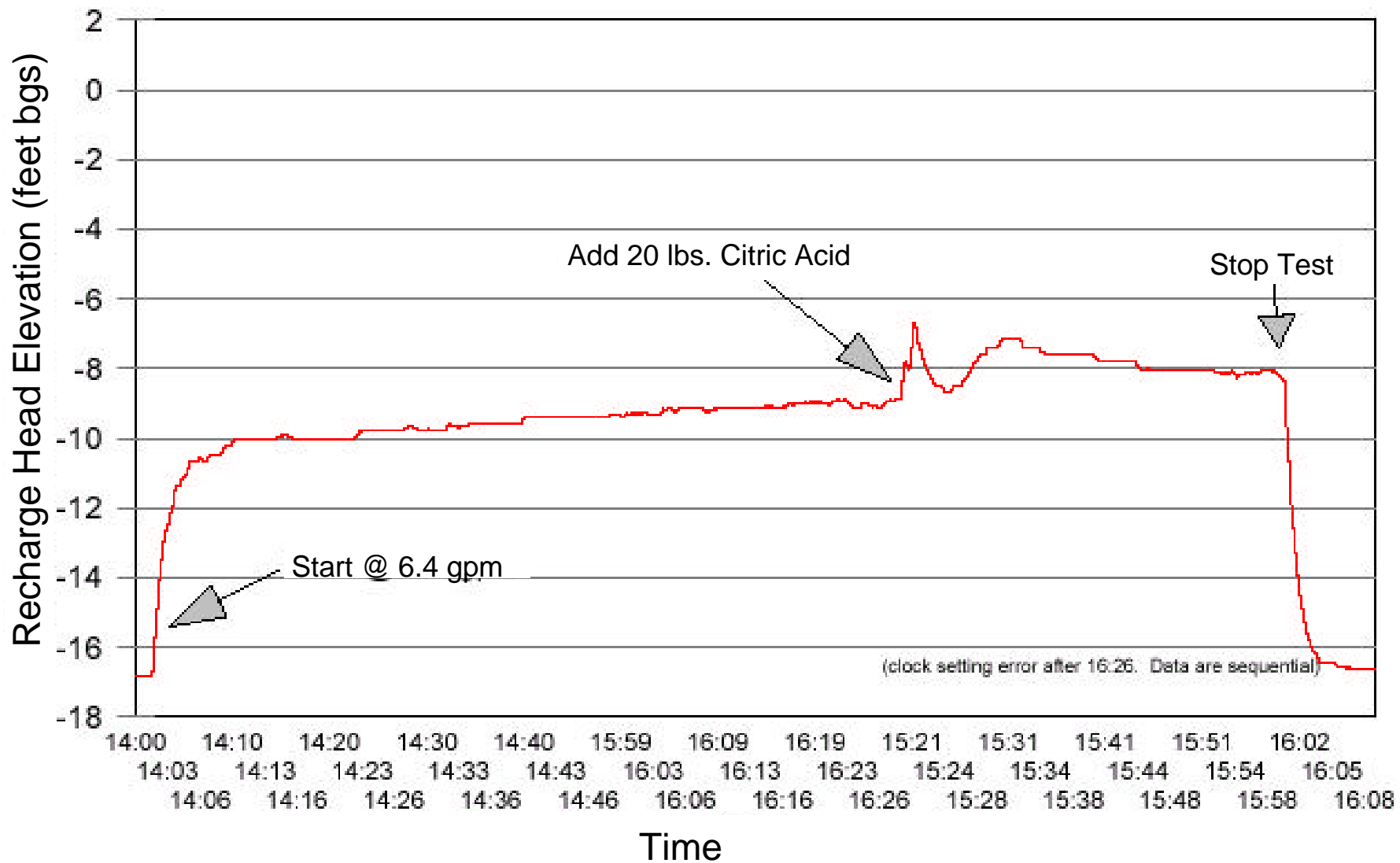

gps gallons per minute
 bgs below ground surface

NoVOCs™ SITE Demonstration
 Site 9, NAS North Island, California

FIGURE 24
NoVOCs™ WELL RECHARGE TEST
DECEMBER 2, 1998

 Tetra Tech EM Inc.

at about 1600 on December 4, 1998. The system was operated overnight with higher than normal injection rates of citric acid solution and HCl to maintain a pH between 1 and 2 within the well. The system exhibited satisfactory water levels and pumping rates and the acid injection rate was gradually reduced until almost no HCl was used and only citric acid was added to maintain the well water pH between 4 and 6. The system was monitored continuously during this startup period to ensure that the recharge level remained in an operable range and responded proportionally to changes in pumping rate. Charts showing the dynamic water level in the recharge piezometer and the indicated pumping rate for this period are shown in Figures 25a through 25d. The system was shut down manually four times to make adjustments during the first 20 hours of operation, but the water level remained stable and responsive to the pumping rate (see Figure 25a). The Thermatrix unit displayed low temperatures at about 0930 on December 5, 1998, and was off line until 1458, when the NoVOCs™ system was restarted (see Figure 25b). The system then operated continuously at an indicated pumping rate of 10 gpm with a stable recharge head in the recharge piezometer until 1100 on December 7, 1998, when the Thermatrix unit went off line.

The system was shut down while the Thermatrix burner head and associated piping were repaired. The carbon steel burner head and some associated stainless-steel piping had been damaged by corrosion, apparently from the HCl produced by the oxidation of the chlorinated compounds in the NoVOCs™ offgas stream.

Final Operating Period. The NoVOCs™ system was restarted at about 1630 on December 10, 1998. At this time, the water level transducer for the recharge piezometer was connected to the system logic controller for data logging. During the system testing and startup in December, the recharge piezometer had been monitored using a stand-alone transducer and data logger unit. The system was left in unattended operation on December 10, 1998, with the operating parameters shown in Table 4.

As part of the final demonstration effort, the Navy established a set of performance criteria that the NoVOCs™ demonstration system must meet in order to continue the demonstration. These criteria included the following primary requirements:

1. The NoVOCs™ system must be operational by December 10, 1998, at an indicated pumping rate of 10 gpm or greater.

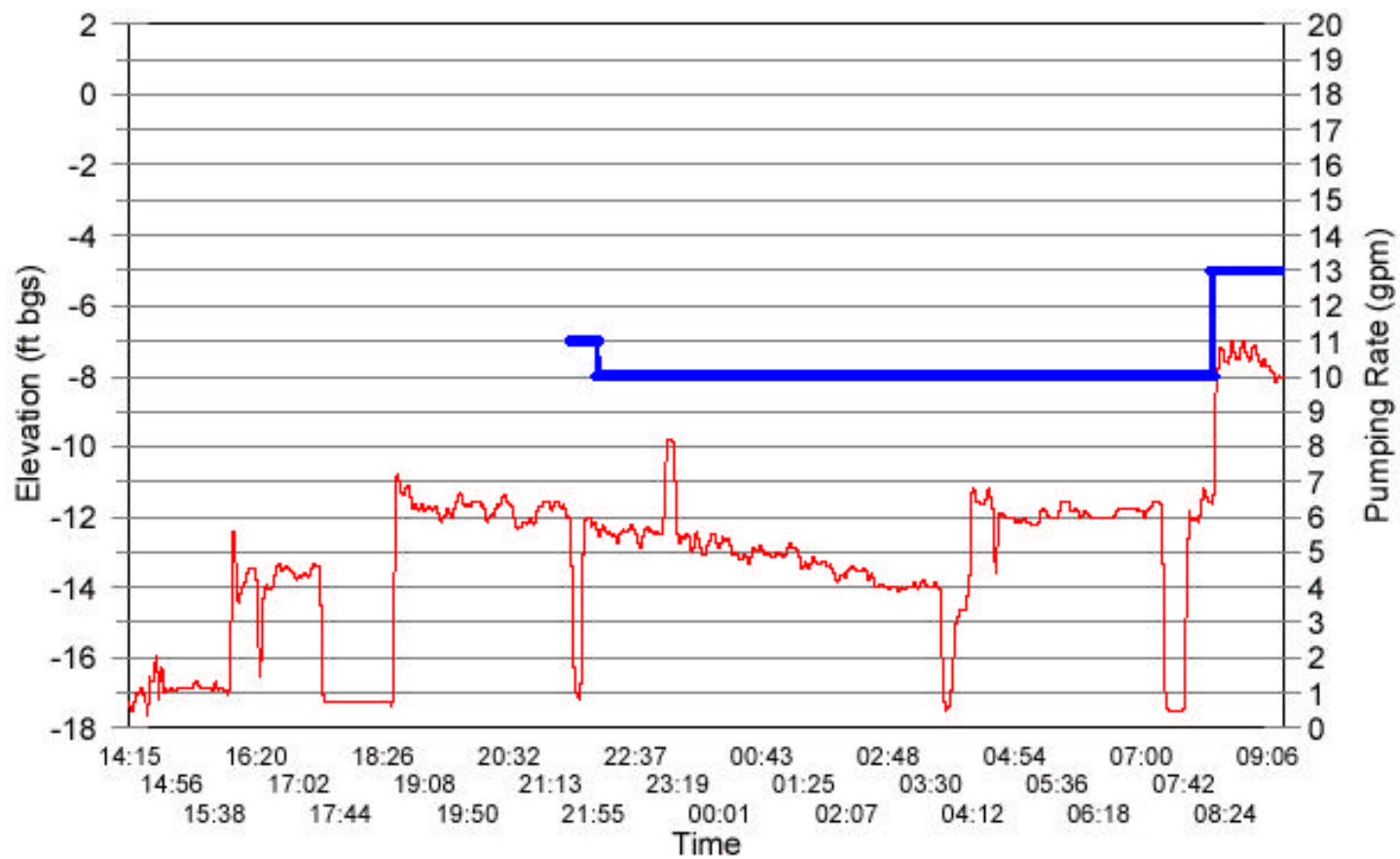

DECEMBER 4

DECEMBER 5

— Elev (feet bgs) — Indicated gpm

bgs below ground surface
gpm gallons per minute

NoVOCs™ SITE Demonstration Site 9, NAS North Island, California
FIGURE 25a NoVOCs™ WELL RECHARGE PIEZOMETER WATER LEVEL - DECEMBER 4 AND 5, 1998
 Tetra Tech EM Inc.

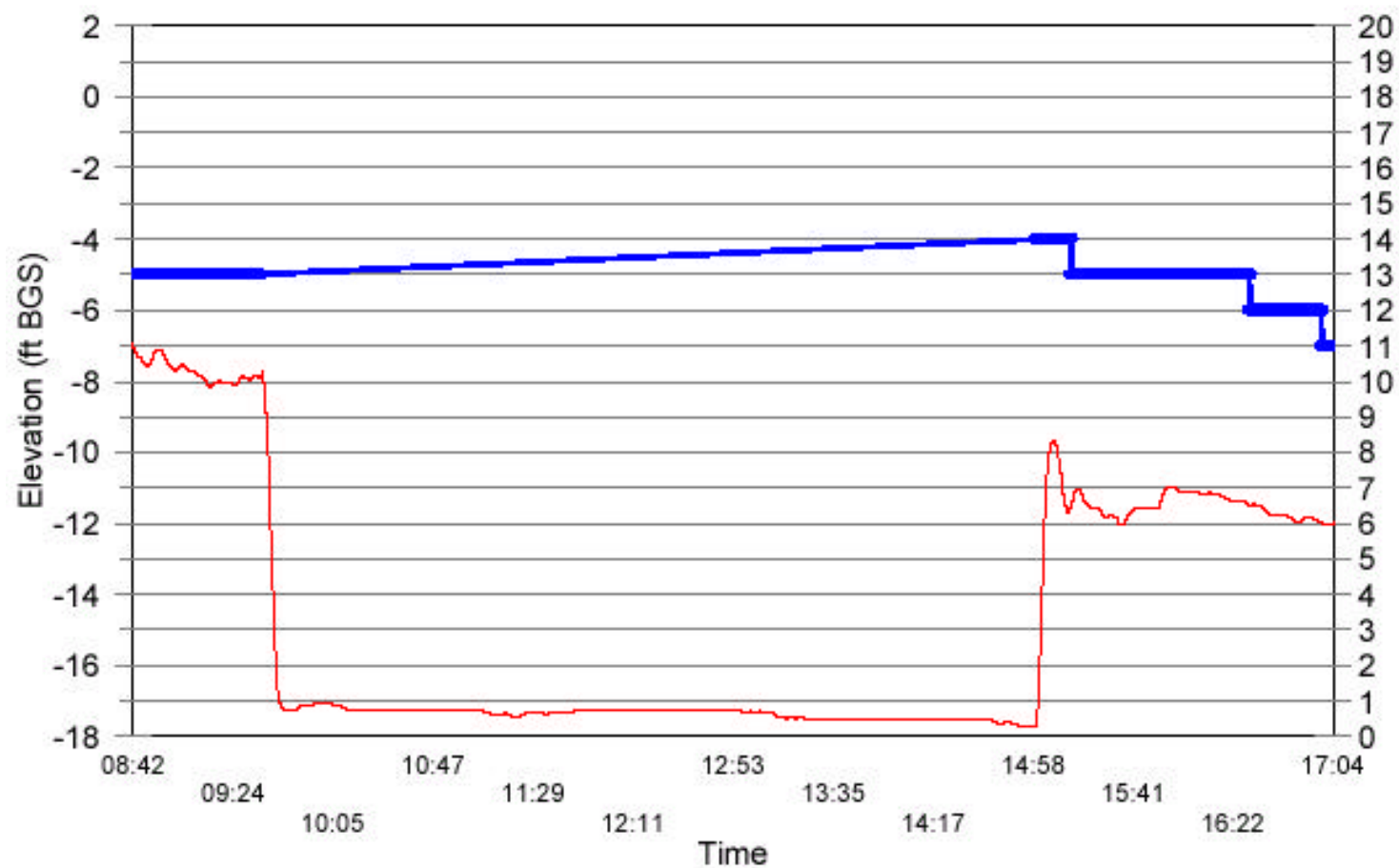

DECEMBER 6

— Elev (ft bgs) — Indicated gpm

bgs below ground surface
gpm gallons per minute

NoVOCs™ SITE Demonstration
Site 9, NAS North Island, California

FIGURE 25b
NoVOCs™ WELL RECHARGE PIEZOMETER
WATER LEVEL - DECEMBER 6, 1998

 Tetra Tech EM Inc.

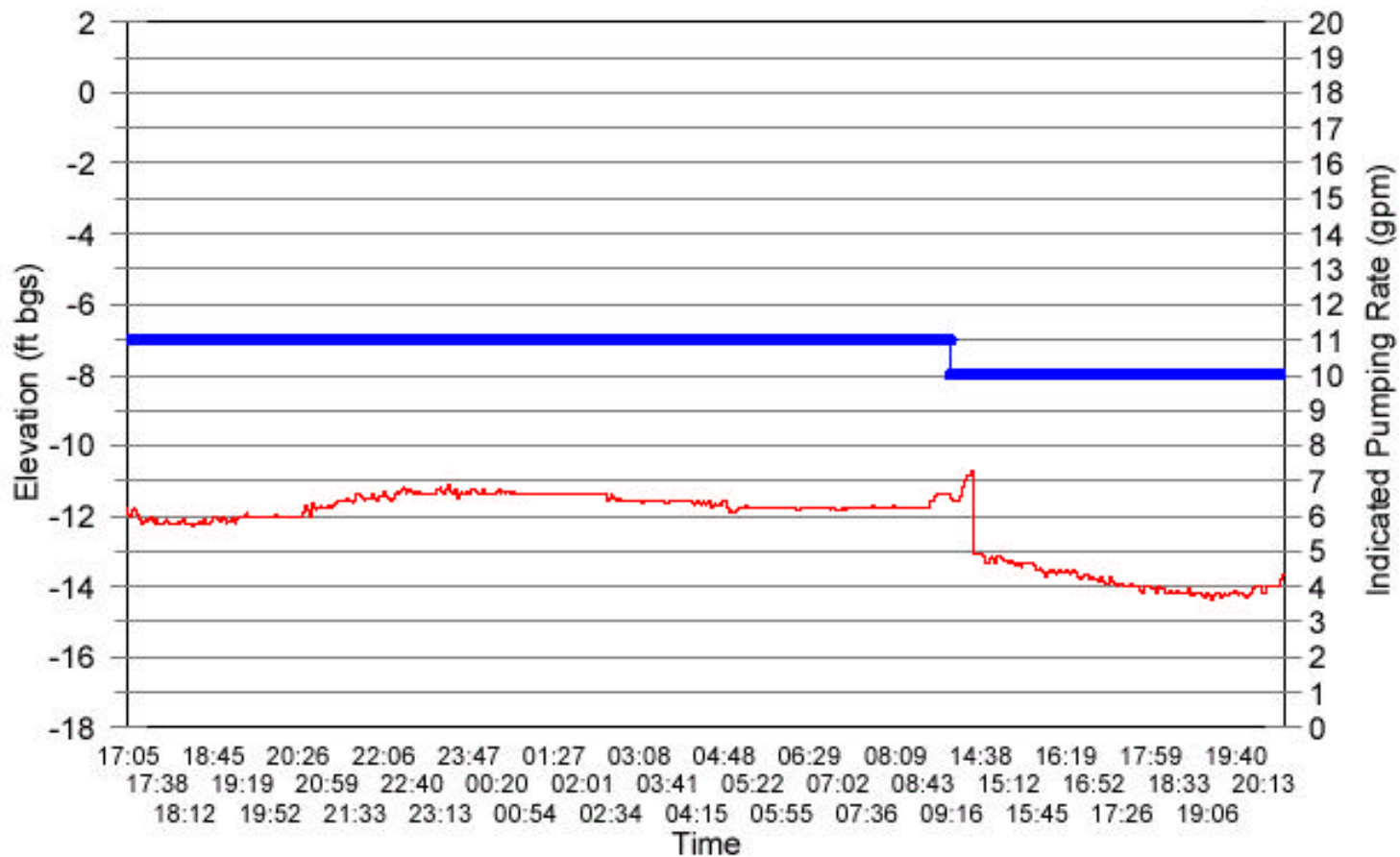

DECEMBER 6

DECEMBER 7

— Elev (feet bgs) —□— Indicated gpm

bgs below ground surface
gpm gallons per minute

NoVOCs™ SITE Demonstration Site 9, NAS North Island, California
FIGURE 25c NoVOCs™ WELL RECHARGE PIEZOMETER WATER LEVEL - DECEMBER 6 AND 7, 1998
 Tetra Tech EM Inc.

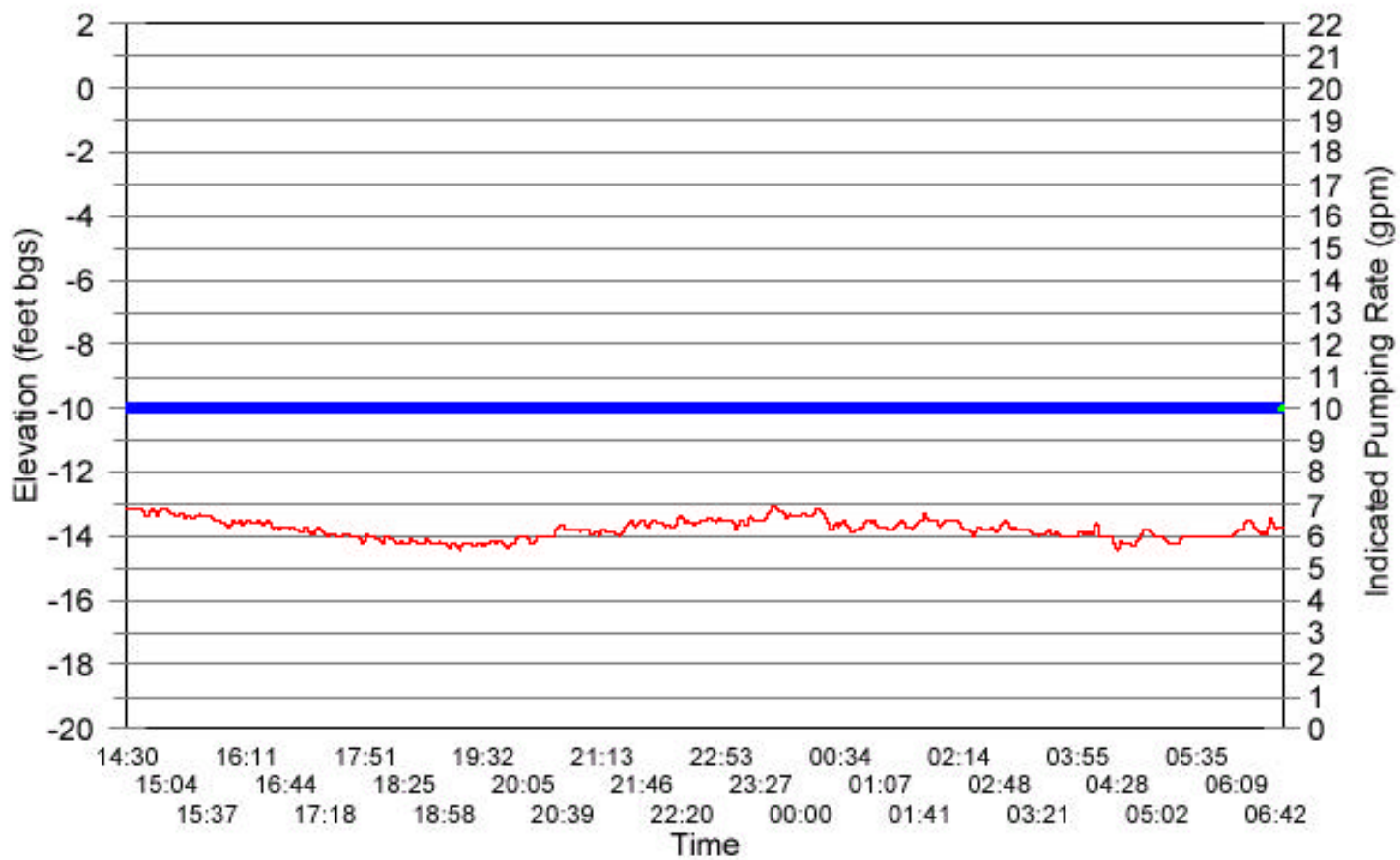

DECEMBER 7

DECEMBER 8

— Elev (feet bgs) — Indicated gpm

bgs below ground surface
gpm gallons per minute

NoVOCs™ SITE Demonstration Site 9, NAS North Island, California
FIGURE 25d NoVOCs™ WELL RECHARGE PIEZOMETER WATER LEVEL - DECEMBER 7 AND 8, 1998
 Tetra Tech EM Inc.

TABLE 4

NoVOCs™ SYSTEM OPERATING PARAMETERS — DECEMBER 10, 1998
NoVOCs™ SITE Demonstration
Site 9, NAS North Island, California

Parameter	Normal Setting/Operating Range (Set Points)	Indicated Range During Final Operation
Initial Airline Submergence	8 to 11 feet below SWL (no set point)	10 feet below SWL
Supply Air Flow	40 to 60 scfm (Shutdown at 0 scfm)	50 scfm (49 to 55 indicated)
Supply Air Pressure	120 to 200 inches WC (Shutdown at 210 inches WC)	129 to 130 inches WC
Supply Air Temperature	100 °F to 180 °F (Shutdown at 210 °F)	130 °F
Supply Air Suction	-5 inches WC (Service filter if -10 or less)	-5 inches WC
pH	2.5 to 7.5 pH units (Shutdown if <= 0 or >= 8)	3.6 to 7.2 pH units
Precipitation Control	As required	Citric acid — 20 percent solution
Biofouling Control	Biocide addition 6 hours/24 hours (1 hour/24 hours)	As programmed (not adjustable)
Wellhead Supply Air Pressure	1.5 to 4.0 psi	2.9 to 3.3 psi
Wellhead Return Air Suction	Net negative pressure	-5 +/- 3 inches WC
Indicated Well Pumping Rate	5 to 15 gpm	10 gpm (range 8 to 13 gpm)
Thermatrix Suction Blower Speed	55 to 60 Hz	60 Hz
Thermatrix Suction	-10 to -30 inches WC	-25 inches WC

Notes:

SWL Static water level
scfm Standard cubic feet per minute
gpm Gallons per minute
psi Pounds per square inch
Hz Hertz
WC Water column

2. If the system were to go off line and not return to operation within 24 hours of a shutdown for any reason, the demonstration would be terminated.

Bechtel staff and subcontractors were able to start operation of the system within the required timeframe and maintain operation of the system an average of 91 percent of the time for the period from December 10, 1998, through January 4, 1999. This was the longest single operational period of the demonstration and the longest operational period with the full complement of sensors and the data logging system in place. The longest downtime during this period was 24 hours from 1600 on December 29, 1998, to 1600 on December 30, 1998. This intensively monitored operating period provided information to support evaluation of the system not only during this period, but also during operation earlier in the year. Plots of data recorded during this period are included in Volume I, Appendix A. The data set recorded includes the following parameters: blower pressure, blower temperature, blower status (on/off), pH in the NoVOCs™ well, and well recharge height.

In addition to the recorded parameters above, a tide prediction algorithm for tidal flux at the Navy Weapons Pier (the nearest shore point to the demonstration site) was developed, and the predicted tidal cycle was added to the recorded data plots. However, the data file for one 24-hour period during this operation (from about 0830 December 21 to 0830 December 22, 1998) was lost. Some significant observations derived from the operational data are discussed below.

- C All of the parameters measured displayed some type of cyclical behavior. These cycles are largely attributed to either tidal cycle effects or diurnal temperature cycle effects. The blower temperature and blower pressure show strong correlation to diurnal temperature (blower temperature is highest in early afternoon). Blower pressure displayed a secondary effect of diurnal temperature. During early operation, Bechtel staff and subcontractors observed that water accumulated in the NoVOCs™ return air moisture separator during the cool periods of the night and evaporated from the separator during the heat of the day. This is consistent with condensation of water vapor from the saturated return air stream. During December, when the diurnal temperature range was more extreme, the collection of condensate reached the switch level in the separator and activated the ejector pump, which pumped the contents of the moisture separator into the supply airline. During this action, the water added to the supply air was observed to substantially increase the supply air pressure. Subcontractor staff confirmed this effect by direct observation during pumpout events.

The differential pressure output from the orifice plate flow sensor was monitored from December 31, 1998, through January 4, 1999, using an independent transducer and data logger. A plot of the indicated pumping rate for that period is shown in Figure 26. Review of the data indicate a strong cyclical pattern; however, correlation of the indicated

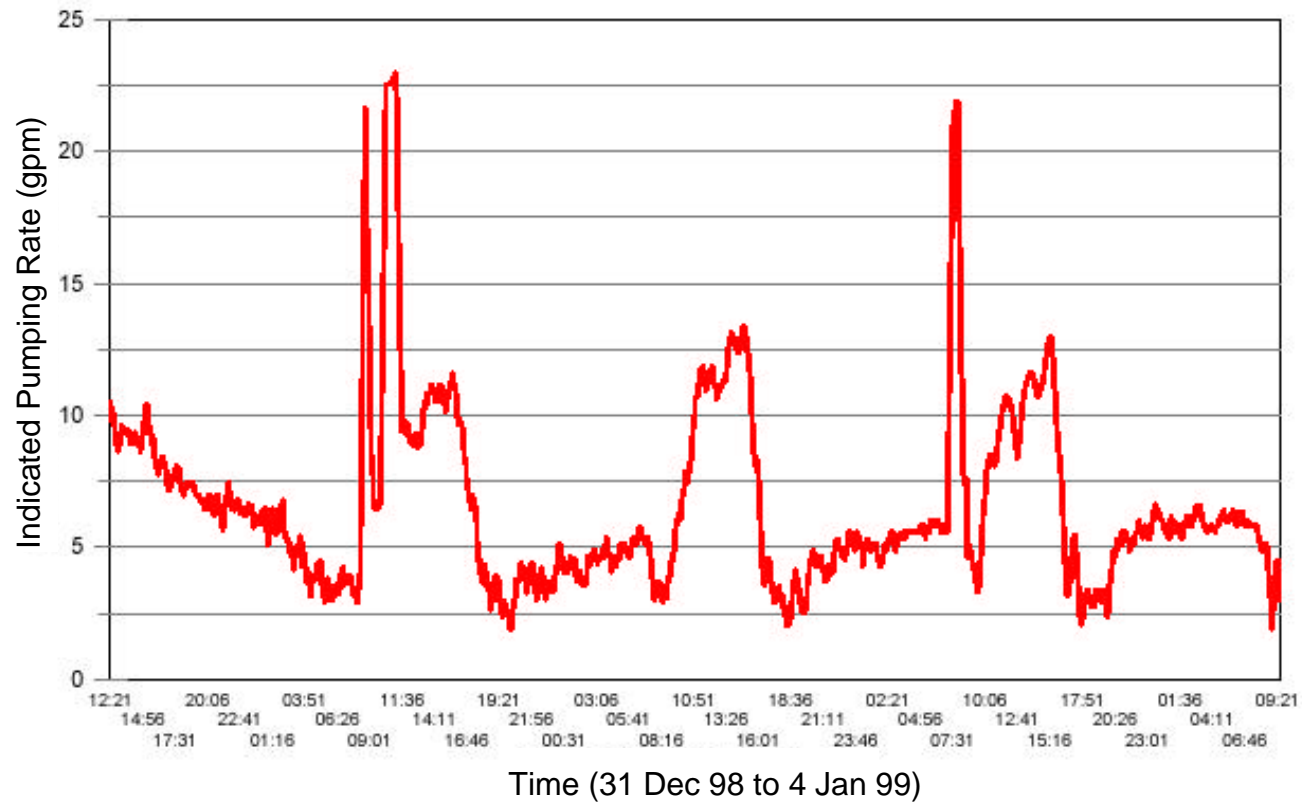

NoVOCs™ SITE Demonstration
 Site 9, NAS North Island, California

FIGURE 26
NoVOCs™ WELL PUMPING RATE
December 31, 1998 through January 4, 1999

 Tetra Tech EM Inc.

pumping rate cycles to either tidal fluctuations or diurnal temperature has not been confirmed.

As expected, recharge water levels displayed tidal cycles superimposed on the water level. The pH level also displayed cyclical behavior that appears to correlate to the tidal cycle. One possible explanation for this cycle could be related to variations in the actual well pumping rate caused by tidal changes in the static water level. With an airlift pump, the pumping rate is directly proportional to the airline submergence (the depth of the air injection point below the static water level). The observed tidal flux in groundwater elevation at the NoVOCs™ demonstration site was a maximum of 0.5 feet. This variation in effective submergence could be expected to cause fluctuation in the pumping rate in cycle with the tide (as the tide rises, submergence increases, and pumping rate increases). An increasing pumping rate would cause dilution of the pH amendment chemical and a resulting slight increase in the observed pH. As the tide falls, the pumping rate would decrease slightly, and the pH would be expected to decrease slightly.

C The recharge water level displayed an increasing trend over time. This trend did not correlate to the observed tidal fluctuation and eventually resulted in a high-level shutdown of the system on December 29, 1998. This condition was diagnosed as resulting from biofouling of the recharge screen as discussed below.

C Control of fouling of the NoVOCs™ well. The NoVOCs™ demonstration well at Site 9 had been plagued by chemical and biological fouling since early in the demonstration. Based on observations of conditions in the well, fouling was diagnosed in three phases. Early in the operation (in April 1998), precipitation of hydrated ferric hydroxide (“iron fouling”) was identified as a problem. The down-hole camera survey conducted in July 1998 also confirmed the presence of biofouling organisms in the well intake (lower) screen. It is likely that biofouling was also present in the recharge (upper) screen; however, because the recharge screen was wiped clean during removal of the internal well components, indications of biofouling were not observed during the video tape survey. MACTEC implemented measures in September 1998 to control both biofouling and iron fouling. Biofouling of the recharge screen was confirmed in December 1998. The initial attempt to control iron fouling through adding a commercial surfactant product was unsuccessful. Substantial accumulation of ferric hydroxide continued during operations in September and October 1998. A review of the manufacturer’s recommended application rate versus the rate of surfactant actually applied revealed that the actual application of the product was substantially below the recommended rate during September and October. Similarly, the actual application of the commercial microbiocide to control biofouling may have varied from the manufacturer’s recommendation. The microbiocide application frequency was programmed into the logic controller and was not user-adjustable. A lower-than-recommended rate of application may have contributed to the continued observed biofouling of the NoVOCs™ well.

Bechtel and subcontractors implemented citric acid addition in December 1998, which was shown to be very effective at controlling iron precipitation in the NoVOCs™ well. The citric acid was prepared by dissolving crystalline citric acid in water to make up a

solution of approximately 20 percent citric acid. This solution was metered into the well at a constant rate during operation to maintain a pH level between 4 and 6. When the high-level shutdown of the NoVOCs™ system on December 29, 1998, was evaluated, the water within the well at both the inlet and recharge zones was found to be clear (turbidity 1.5 to 2.5 NTU) and all iron was in solution (that is total and dissolved iron were equal concentrations). A summary of the iron concentration, pH, dissolved oxygen, and turbidity data observed in three zones of the well on December 30, 1998, is shown in Table 5.

Because the restart schedule did not permit disassembly of the well for diagnosis, the NoVOCs™ well outlet screen was evaluated for fouling by lowering a weighted tube into the well annulus and pumping continuous water samples from the annulus with a peristaltic pump. This approach revealed the accumulation of substantial quantities of filamentous microbial colonies across the full length of the recharge screen. These colonies were visually similar to the colonies observed in the inlet screen during the down-hole camera survey in July. This biofouling was the apparent cause of the high-level conditions in the NoVOCs™ well during the December time period. The apparent inability of the biocide injected into the intake screen zone to control fouling of the recharge screen may be related to one, or all, of three conditions: (1) the rate of addition of the biocide was insufficient to control the microbes in the well; (2) the biocide, or some active ingredient, may have been removed during the in-well stripping process, thus providing no active ingredient to the outlet screen; and (3) the biocide may have been somehow inactivated by the in-well stripping process or other conditions in the well.

To facilitate the timely restart of the system, Bechtel and subcontractors made an aggressive treatment of the recharge screen using the available biocide solution and hydrogen peroxide solution. The treatment solutions were placed in the recharge screen zone using the weighted tube and peristaltic pump that were used to diagnose the problem. Five gallons of biocide solution were placed in the recharge zone and left undisturbed for several hours. This was followed by placement of 5 gallons of 3 percent hydrogen peroxide solution and 4 gallons of 35 percent hydrogen peroxide solution to disrupt the microbial colonies. This treatment proved effective and the system was restarted on December 30, 1998, within the required 24-hour restart period. The controller programming could not be changed to increase the microbiocide injection frequency. However, the apparent water level within the well continued to rise, and subsequent high-level shutdowns were encountered on January 3 and 4, 1999. These shutdowns were accompanied by stable and declining water levels in the recharge piezometer, which suggests that biofouling of the recharge screen was the likely cause of the shutdowns.

The discovery of microbial colonies in the recharge screen in December suggests the possibility that the NoVOCs™ well had suffered biofouling in addition to iron fouling during early operations in May and June 1998. The presence of microbial colonies on the inlet screen in July, prior to implementation of any chemical amendments other than pH adjustment, indicated the possibility of biofouling of the upper (recharge) screen as well. During the earlier evaluation of the well, the eductor pipe was removed. This was done before development in May 1998 and before the down-hole camera survey in July 1998.

TABLE 5

**RESULTS OF FIELD ANALYSES — DECEMBER 30, 1998
NoVOCs™ SITE Demonstration
Site 9, NAS North Island, California**

Analysis	Well Inlet Zone	Well Recharge Zone	Recharge Piezometer
Dissolved Iron (mg/L)*	5	4	10
Total Iron (mg/L)*	5	4	10
pH (units)	4.5	4.5	4.2
Dissolved Oxygen (mg/L)	4	5	2
Turbidity (NTU)	2.5	1.5	120 66 (after 5 minutes)

Notes:

mg/L Milligram per liter

NTU Nephelometric turbidity units

* Iron analysis by colorimetric determination using CHEMets™ test kit.

The shale trap packer attached to the eductor pipe would be expected to wipe the inside surface of the recharge screen clean as the eductor is removed. This is likely the reason that the recharge screen appeared to be free of biofouling during the camera survey.

3.1.3 System Operation and Maintenance

The NoVOCs™ system required extensive maintenance during the demonstration. As shown in Volume I, Appendix A, Table A1, during the demonstration the NoVOCs™ system was down about 33 percent of the time. Operation and maintenance problems causing shutdown of the NoVOCs™ system were primarily related to (1) well fouling, (2) pH problems in the NoVOCs™ well, and (3) maintenance problems with the Thermatrix system. Additional periods of inactivity were associated with system design changes. A summary of the operation and maintenance problems is provided in Volume I, Appendix A, Table A2.

Well Fouling and Fouling Control. Well fouling can be the cause of substantial maintenance effort with any groundwater treatment system. The NoVOCs™ demonstration well at NAS North Island required

substantial maintenance effort to manage fouling by microbial colonization (biofouling) as well as direct chemical precipitation of ferric hydroxide. In-well stripping systems and recirculating wells, such as the NoVOCs™ system, are subject to fouling from a variety of common causes, like any other production well and like many aboveground treatment technologies. The three most common causes of fouling in production wells are (1) accumulation of silt in the well structure, (2) formation of chemical precipitates and insoluble mineral species, and (3) biofouling by colonizing microorganisms. These issues and their relationship to the NoVOCs™ demonstration well are discussed below.

Fouling of recirculating wells is a recognized problem that requires diagnosis, design considerations, and operation and maintenance activities for successful management. Fouling can cause system failure due to reduced screen capacity in recirculating wells. Fouling can also extend into the filter pack and formation outside of the well.

Initial fouling control efforts at the NoVOCs™ demonstration well were approached systematically. Silt accumulation were to be controlled through design and construction of filter pack and well screen combinations that were appropriately sized for the formation sands at the site and by thorough development of the well prior to startup. Calcite scaling was to be managed through pH control based on the results of bench testing using samples of groundwater from the site during the detailed design phase (see Figures 16 and 17). The preliminary information available during system design indicated relatively low dissolved iron concentrations in groundwater (less than 0.1 mg/L) so iron precipitation control was not included in the initial design. Biofouling was not specifically assessed during system design.

Siltation Effects. The NoVOCs™ well exhibited minor fouling by silt and fine sand during the demonstration. A small quantity of fine sand (a volume of about one gallon) was removed from the well foot during inspection and redevelopment in May 1998. The water produced from the well exhibited very low turbidity (less than 5 NTU) following development. No significant quantities of formational silt or sand were deposited atop the shale trap packer on the eductor pipe after operation, also indicating thorough development and proper function of the screens and filter packs.

Iron Fouling. The NoVOCs™ demonstration well began to display substantial accumulation of flocculated hydrated ferric hydroxide within a few weeks of startup. The dissolved iron content of the groundwater in the NoVOCs™ well was also observed to be higher, ranging up to 4 mg/L after a period of operation. The precipitated iron is believed to have played a major role in fouling the recharge screen in

May and June 1998 with resultant high water level shutdowns of the NoVOCs™ system. The formation of insoluble ferric hydroxide by direct aeration of water containing dissolved ferrous iron is a predictable process. As water containing dissolved ferrous iron (Fe^{+2}) is aerated, the ferrous iron is oxidized to trivalent ferric iron, forming hydrated ferric hydroxide molecules. Hydrous ferric hydroxide polymerizes to form macroscopic particles, which can bridge screen slots and settle in quiescent areas to cause fouling problems. An iron speciation diagram is shown in Figure 27.

The solubility of iron in water is highly dependent on both the pH of the water and the oxidation/reduction (redox) potential (Eh). As shown in Figure 27, at near-neutral pH, iron can exist as either a soluble ion (divalent ferrous iron, Fe^{+2}), or one of two insoluble species (pyrite [FeS_2], a common species in reduced saline waters, or ferric hydroxide, [$\text{Fe}(\text{OH})_3$]) depending on the redox potential. It is important to note that increasing the redox potential at this near-neutral pH range can result in an initial increase in ferrous iron from dissolution of pyrite minerals, with subsequent precipitation of ferric hydroxide as the redox potential approaches equilibrium with air. A detailed assessment of reduced iron mineralogy was not conducted during this NoVOCs™ demonstration. The redox potential of the contaminated zone surrounding the NoVOCs™ well inlet, however, was measured during aquifer testing and found to be slightly negative (i.e., -0.03 volt).

The in-well stripping action of the NoVOCs™ process tends to drive the redox potential toward equilibrium with air (approximately 0.75 volts) (see Figure 27). At the pH typically encountered in natural groundwater (pH 5.0 to pH 8.5) this will result in the formation of ferric hydroxide. The degree of precipitation of ferric hydroxide after aeration was determined in bench tests conducted by Bechtel subcontractors in June 1998. Dissolved iron concentration in a sample of groundwater from the NoVOCs™ demonstration site was 2.2 mg/L. After aeration, visible ferric hydroxide flocs settled in the beaker and the dissolved iron concentration decreased to 0.41 mg/L, corresponding to precipitation of 81 percent of the dissolved iron as ferric hydroxide (see Figure 27).

The internal components of the NoVOCs™ well were observed to be covered with a thick layer of gelatinous hydrous ferric hydroxide when removed from the well in May, June, and July, 1998. This gelatinous material rapidly dehydrates on exposure to air, leaving a thin layer of powdery orange ferric oxide. Depending on the degree of hydration and polymerization, ferric hydroxide deposits will exhibit a

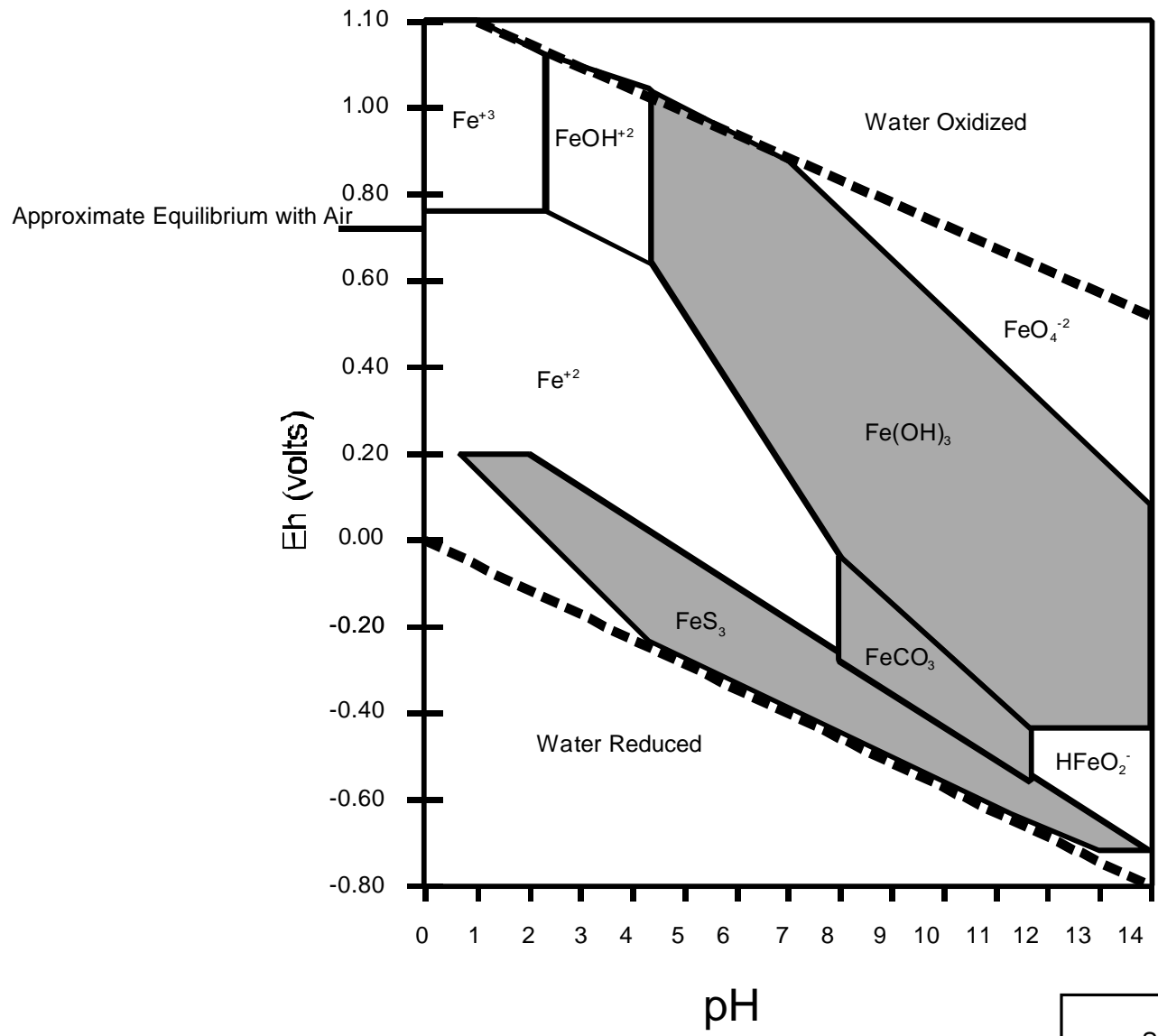

(modified from Hackett and Lehr, USACOE, 1985)

NoVOCs™ SITE Demonstration Site 9, NAS North Island, California
FIGURE 27 SIMPLIFIED IRON STABILITY DIAGRAM
 Tetra Tech EM Inc.

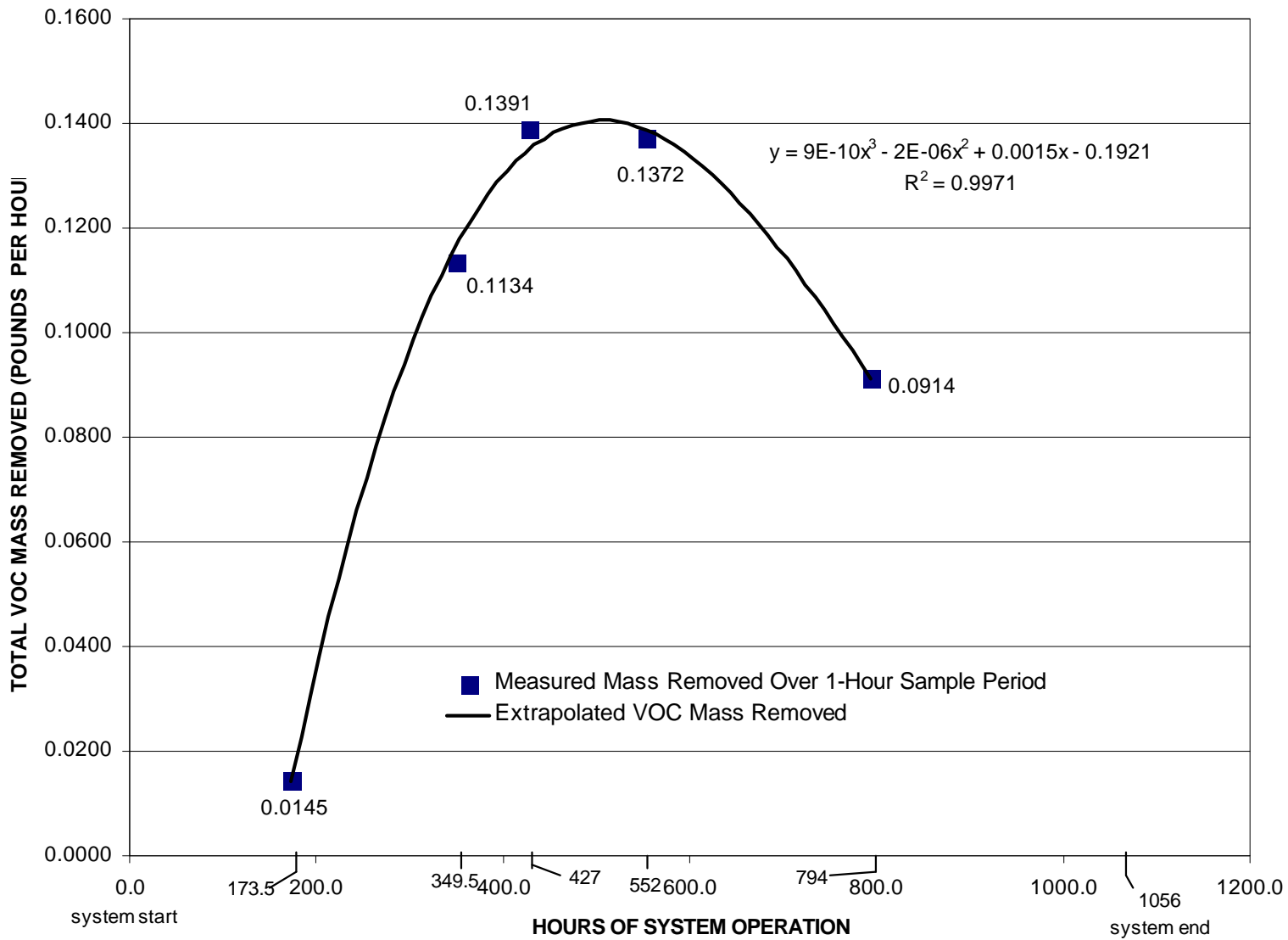

NoVOCs™ SITE Demonstration
 Site 9, NAS North Island, California

FIGURE 28
TOTAL VOC MASS REMOVED
BEST FIT TREND LINE

volume reduction of 300 to 600 percent when exposed to dry air. The accumulation of ferric hydroxide deposits has been observed previously in other NoVOCs™ installations and has been associated with other in-well stripping systems.

Ferric hydroxide deposits are also produced as a metabolic by-product by iron oxidizing bacteria, a group of numerous genera of common terrestrial and aquatic bacteria that derive energy from the oxidation of ferrous iron to ferric iron. Based on observation of the volume and placement of ferric hydroxide flocs during the down-hole camera survey of the NoVOCs™ demonstration well, most of the iron fouling appears to have been caused by direct oxidation of ferrous iron, with a potential for a smaller amount produced by iron-related bacteria located in the well inlet screen zone. Ferric hydroxide produced by microbial oxidation is generally indistinguishable chemically from that produced by direct oxidation by air.

The commercial product selected by MACTEC for control of ferric hydroxide precipitation was found to be ineffective at the rate and manner in which it was applied. The NoVOCs™ well exhibited continued accumulation of ferric hydroxide after the reconfigured system was started and operated in September and October. In December, Bechtel replaced the commercial surfactant product with a citric acid solution, which provided satisfactory control of ferric hydroxide precipitation. The effect of these iron precipitation control products (citric acid and the commercial dispersant) as a carbon source for microbes in the well was not evaluated.

Biological Fouling. Biological fouling of the NoVOCs™ demonstration well was first confirmed during the down-hole camera survey in July by observation of microbial colonies in the inlet screen. These colonies appeared generally as white to hyaline tufts of microbial mat attached to numerous inlet screen slots and partially blocked the inlet screen. Some distinct colonies exhibited orange coloration consistent with that of ferric hydroxide, suggesting that at least some of the colonies were iron-oxidizing bacteria. The outlet screen of the NoVOCs™ well was observed to be clear of biofouling during the camera survey; however, removal of the eductor pipe with its attached shale trap packer would have scraped microbial deposits from the outlet screen before the camera survey. In retrospect, it appears likely that the same degree of biological fouling observed in the inlet screen was also present in the outlet screen, but was not actually observed until later in the demonstration (December 1998). This biofouling of the outlet screen likely contributed to the reduced recharge capacity observed in May and June 1998, as well as later in the demonstration, as discussed below.

Bechtel staff collected a sample of the water removed from the well during development activities in July 1998 for a microbial screening analysis for iron-related bacteria, sulfur-related bacteria, and slime-forming bacteria. The results of this screening are summarized below. Bacterial populations were rated on a scale of 0 (absent) to 10 (high).

- C The iron-related bacteria reaction showed iron bacteria growing, at least in part, in anaerobic conditions or at the redox front. There may well be significant populations of enteric bacteria with species of either *Klebsiella* and/or *Enterobacter* dominating. The population of bacteria was measured at 7.

- C The first sulfur-reducing bacteria (SRB) showed bacteria growing covertly within slimes composed of a variety of slime-forming bacteria. The second reaction showed SRB bacteria growing within loose forms of slime in association with aerobic bacteria. The third reaction showed a diverse SRB community which was, in part, functioning with other aerobic and anaerobic bacteria. The population of SRBs were measured at 3.8.

- C The first slime bacteria reaction showed a complex community of aerobic bacteria, many of which are able to grow on the redox front. The second reaction showed aerobic or anaerobic bacteria able to form gel-like slimes that may be easily disrupted. The third reaction showed that bacterial fouling was occurring involving a mixture of enteric and pseudomonad bacteria. The population was measured at 3.3.

These results suggested that bacteria pose a moderate to high risk for clogging, a low to high risk for corrosion, and were moderately to extremely aggressive. To address this problem, MACTEC collected groundwater samples from the NoVOCs™ well to determine the best approach to minimize iron precipitation and biofouling of the well. Based on the analysis of the groundwater sample, MACTEC modified the chemicals being injected in the well to include a modified hydroxylate copolymer to control scaling in the well and a bromine/chlorine biocide solution to control biofouling of the well, as discussed in Section 3.1.2. Injection of the modified chemical treatment began in September 1998 during operation of the NoVOCs™ system under redesigned operating conditions.

The selected treatment for biofouling of the NoVOCs™ well was a commercial microbiocide, a highly-oxidizing bromine/chlorine donor. This product was injected by a metering pump into the intake piezometer located in the filter pack outside of the inlet screen at the bottom of the well. This product did not appear to be effective as applied to the NoVOCs™ well. After restarting the system in December 1998, a high water level condition was observed in late December (see operations discussion in Section 3.1.2). Diagnosis of the condition revealed substantial microbial growth fouling the recharge screen of the

NoVOCs™ well. Bechtel submitted a sample of water containing this material for microbial screening. The results of the screening (with relative populations reported on a scale of 0 to 10) are summarized below.

- C Three types of slime-forming bacteria were identified with a relative population of 7, a moderate clogging risk. These microbes were described as being extremely aggressive.
- C Highly-aggressive SRB were present within the slimes. These microbes present a moderate clogging risk and were present in a relative population of 2.4.
- C Extremely aggressive iron-related bacteria and populations of enteric and pseudomonad bacteria were present at relative populations of 7. These bacteria present a high clogging risk.

The consortium of microbes identified in the recharge screen in December is very similar to that identified in July in the well inlet screen. A photograph of specimens of the organisms sampled in December is shown in Figure 19d. The reasons for ineffective results from the microbiocide applications are not readily apparent.

System pH. Airlift pumping used by the NoVOCs™ system introduces oxygen into the treated groundwater. Introduction of oxygen results in higher oxidizing conditions in the groundwater, which will tend to precipitate redox sensitive elements such as iron and manganese. Additionally, elevated concentrations of aqueous iron support the growth and proliferation of iron-related bacteria. The precipitation of an inorganic such as iron and associated bacterial growth can potentially plug the well screen or the surrounding aquifer or reduce the hydraulic conductivity of the formation. Airlift pumping also causes the removal of CO₂ from the treated groundwater. For carbonate-rich groundwater, stripping of CO₂ causes an increase in pH in the treated groundwater and the subsequent precipitation of calcium minerals (calcite), which may adversely impact the ability of well screens, the filter pack, and the adjacent formation to transmit water.

To address these potential problems, HCl was injected into the water treated by the NoVOCs™ system using an automatic pH control system. Initial pH injection settings were determined by conducting sparge and titration tests on groundwater from the demonstration site. Based on the results of the sparge and titration tests, approximately 0.25 milliliters (ml) of 30 percent HCl solution per liter of treated water was required to return the pH to a point near the initial pH of 7.40 to 7.80. During operation of the NoVOCs™ system, several problems with the pH control system were encountered. On one occasion, the

pH electrode was shorted by water leaking into the electrode support pipe. The pH signal pre-amplifier batteries proved to have relatively short service lives and required replacement on an irregular basis. As the NoVOCs™ well began to display reduced recharge capacity, pH control began to display off-normal conditions due to the reduced well pumping rate. The acid addition system, while correctly sized for the design flows, was oversized for the reduced rates encountered during periods of fouling of the recharge screen.

Thermatrix System. Because the NoVOCs™ and Thermatrix systems were interconnected, problems with one system would cause the other system to go off line. On several occasions, the NoVOCs™ system was shut down because of maintenance problems with the Thermatrix system. For the most part, the Thermatrix system operated with few problems until September 1998. During the redesigned operational period, the Thermatrix system began experiencing maintenance problems, including high pH levels, low quench levels, and clogged injection jets. Most of these problems appeared to be related to the Thermatrix system not being operated for more than 3 months.

3.1.4 Colloidal Borescope

In October 1997, the Navy measured groundwater direction and velocity in five wells at Site 9 using an innovative in situ field measurement device, known as the colloidal borescope. The colloidal borescope provides direct means of accurately determining groundwater flow direction in a well by measuring the movement of natural particles in the groundwater within the well. The colloidal borescope was developed by Oak Ridge National Laboratory's (ORNL) Environmental Technology Section and consisted of a set of lenses and miniature video cameras capable of observing natural particles in monitoring wells. Based on field observations of these particles, in situ groundwater velocity and flow direction in a well can be measured.

The colloidal borescope consists of two charge-couple device (CCD) cameras, a ball compass, an optical magnification lens, an illumination source, and stainless-steel housing. Upon insertion into a well, an electronic image magnified 140 times is transmitted to the surface, where it is viewed and analyzed. The compass is viewed by one of the CCD cameras to align the borescope in the well. As particles pass beneath the lens, the back-lighting source illuminates the particle (similar to a conventional microscope with a lighted stage). A video frame grabber digitizes individual video frames at intervals selected by the operator. The software compares the two digitized video frames, matches particles from the two images,

and assigns pixel addresses to the particles. Using this information, the software program computes and records the average particle size, number of particles, speed, and direction. A computer can analyze flow measurements every 4 seconds, resulting in a large database after only a few minutes of observations.

Of the five wells measured at Site 9, a reliable flow rate was recorded in one of the five wells, well S9-DMW-1, at a depth of 61.8 feet below casing level, while the remaining flow rates taken at various intervals in the other test wells did not yield a reliable flow measurement. ORNL believes that several factors were responsible for this unreliability in measurements (for example, vertical flow and clogged well screens), and that with some equipment modifications and redevelopment of the existing wells, it would be possible to obtain reliable flow measurements using the colloidal borescope.

Over 5 hours of data were collected from monitoring well S9-DMW-1. The data indicated that groundwater flows in a west-southwest direction at an average corrected velocity of 5 ft/day. This velocity measurement is for a preferential flow zone and has been reduced the maximum amount to take into account the effects of the borehole. Based on groundwater elevation data collected by Bechtel, this flow direction is consistent with site data that suggests a southern component in a generally western groundwater flow direction.

Because of the limited results of the earlier colloidal borescope investigation, shoreline monitoring wells 9-MW-18 and 9-MW-26 were selected and tested using the colloidal borescope instrument in March 1998. Both wells showed a west-southwest flow direction that was consistent with earlier observations.

3.1.5 Diffusion Multi-Layer Sampler

In May 1998, the Navy conducted field sampling of monitoring well MW-54 using a Diffusion Multi-Layer Sampler (DMLS™) to evaluate the vertical distribution of contaminant in the groundwater in the vicinity of the NoVOCs system. The DMLS™ is a passive, multi-layer sampling device that consists of a series of connected rods with openings at specific intervals to accommodate proprietary dialysis cells. The dialysis cells consist of a polypropylene vial filled with distilled water, which are covered by permeable membranes at both ends. Each cell is an independent sampling unit, separated by flexible seals that fit the inner diameter of the well. When a dialysis cell is exposed to groundwater with concentrations of solutes different from that inside the cell, a natural process of diffusion of solutes from higher concentrations to lower concentrations occurs.

A 35-foot-long DMLS™ with dialysis cells spaced approximately every 2 feet was installed in monitoring well MW-54 on May 6, 1998. The dialysis cells were allowed to equilibrate with the surrounding groundwater for a period of 7 days. On May 13, 1998, the DMLS™ was removed and a total of 18 discrete dialysis cells were collected for subsequent analysis at an analytical laboratory.

Analytical results from the samples collected using the DMLS™ provided a detailed vertical profile of the contaminant concentrations at Site 9. The primary VOCs detected were PCE, TCE, 1,1-DCE, 1,2-DCE, and vinyl chloride. Based on a review of the contaminant concentrations, the distribution of these contaminants appeared to be stratified. Elevated levels of total VOCs were detected in the four samples collected from 45 to 50.2 feet bgs. Total VOC concentrations in this zone exhibited a decreasing trend with depth from a high of 20,339 Fg/L at 45 feet bgs to a low of 6,018 Fg/L at 50.2 feet bgs. Lower concentrations of total VOCs were detected in the six samples collected from 52.3 to 62.6 feet bgs. Total VOCs in this zone ranged from 807 to 3,778 Fg/L and exhibited no apparent trends. The highest concentrations of total VOCs were detected in eight samples collected from 64.7 to 79 feet bgs. These samples exhibited a trend of increasing total VOC concentrations with depth from a low of 54,613 Fg/L at 64.7 feet bgs to a high of 98,028 Fg/L at 79 feet bgs. A summary of the DMLS™ analytical results is present in Volume I, Appendix A, Table A-36.

Based on discussions with Bechtel and review of the borehole log from the NoVOCs well, the observed contaminant stratification may be related to site stratigraphy. A correlation appears to exist in the sudden and marked increase in total VOC concentrations observed in samples collected at 62.5 feet and below and the dense sand layer encountered at about 61 feet bgs.

3.2 RESULTS

This section presents the results of the SITE evaluation of the NoVOCs™ technology at NAS North Island, California. The results are presented by project objective and have been interpreted in relation to each objective. The specific primary and secondary objectives are shown at the top of each section in italics followed by a discussion of the objective-specific results. Data quality based on these results is presented in Section 3.3.3.

3.2.1 Primary Objectives

Primary objectives were considered to be critical for the evaluation of the NoVOCs™ technology. Three primary objectives were selected for the SITE evaluation of the NoVOCs™ technology. The results for each primary objective are discussed in the following subsections.

3.2.1.1 Primary Objective P1

Evaluate the removal efficiency of the NoVOCs™ well system for VOCs in groundwater.

This objective was achieved by collecting groundwater samples from piezometers adjacent to the system intake (PZ-02) and recharge (PZ-01) and analyzing the samples for VOCs. Because the NoVOCs™ system did not operate continuously over the anticipated demonstration period, groundwater samples were only collected during the first, second, and third weekly, and first monthly sampling events. In addition to VOC data collected during the SITE evaluation, VOC data collected by Bechtel were also documented. The analytical results for VOCs detected in the system intake (PZ-02) and recharge (PZ-01) piezometers for both the Tetra Tech and Bechtel sampling events are summarized in Table 6. While the initial objective included calculating a removal efficiency for PCE, TCE, DCE, vinyl chloride, and BTEX, only three VOCs were consistently detected at measurable concentrations during the system demonstration: 1,1-DCE, cis-1,2-DCE, and TCE. As such, removal efficiencies were only calculated for these three compounds.

The results indicate that the NoVOCs™ system effectively removed these target compounds from the groundwater. 1,1-DCE was reduced by greater than 98 percent in all events except the first Bechtel sampling event on February 6, 1998. Cis-1,2-DCE was reduced by greater than 95 percent in all sampling events, except the first Bechtel sampling event. TCE was reduced by greater than 93 percent in all the sampling events except the first Bechtel sampling event. Removal efficiencies calculated during the first Bechtel sampling event for 1,1-DCE, cis-1,2-DCE, and TCE were 90, 48, and 76 percent,

TABLE 6

**TREATMENT SYSTEM REMOVAL SUMMARY
NoVOCs™ SITE Demonstration
Site 9, NAS North Island, California**

Well	Description	Sampling Event								
		Bechtel 3/4/98	Bechtel 3/19/98	Tetra Tech 1st Weekly 4/28/98	Bechtel 4/29/98	Tetra Tech 2nd Weekly 5/6/98	Tetra Tech 3rd Weekly 5/12/98	Tetra Tech 4th Weekly 5/21/98*	Tetra Tech 1st Monthly 6/8/98	Bechtel 6/8/98
1,1-Dichloroethene (Fg/L)										
PZ-02	System Intake	2,700	2,800	2,300	4,400	2,400	3,100	NA	4,300	5,400
PZ-01	System Recharge	270	50	25	30	16	26	NA	9.3	34
Percent Reduction ⁽¹⁾		90	98	99	99	99	99	NC	99	99
cis-1,2-Dichloroethene (Fg/L)										
PZ-02	System Intake	13,000	40,000	45,000	52,000	39,000	40,000	NA	46,000	53,000
PZ-01	System Recharge	6,700	2,100	1,800	1,500	1,200	1,500	NA	580	1,100
Percent Reduction ⁽¹⁾		48	95	96	97	97	96	NC	99	98

TABLE 6 (Continued)

**TREATMENT SYSTEM REMOVAL SUMMARY
NoVOCs™ SITE Demonstration
Site 9, NAS North Island, California**

Well	Description	Sampling Event								
		Bechtel 3/4/98	Bechtel 3/19/98	Tetra Tech 1st Weekly 4/28/98	Bechtel 4/29/98	Tetra Tech 2nd Weekly 5/6/98	Tetra Tech 3rd Weekly 5/12/98	Tetra Tech 4th Weekly 5/21/98*	Tetra Tech 1st Monthly 6/8/98	Bechtel 6/8/98
Trichloroethene (Fg/L)										
PZ-02	System Intake	790	1,300	760	1,600	1,900	2,000	NA	2,300	1,700
PZ-01	System Recharge	190	65	50	25	26	27	NA	9.2	18
Percent Reduction ⁽¹⁾		76	95	93	98	99	99	NC	99	99

Notes:

Fg/L Micrograms per liter

NA Not analyzed

NC Not calculated

* Groundwater samples were not collected from PZ-01 and PZ-02 during the fourth weekly sampling event.

⁽¹⁾ Percent reduction = $[(C_{(w-1)} - C_{(w-2)}) / C_{(w-1)}] \times 100$; where $C_{(w-1)}$ = PZ-02 and $C_{(w-2)}$ = PZ-01

Bolded values are above the reporting limit

respectively. The lower removal efficiencies calculated during this sampling event are believed to be related to the fact that the sampling event was conducted during system shakedown activities. A summary of the removal efficiencies are provided in Table 6.

The upper confidence limit (UCL) for 1,1-DCE, cis-1,2-DCE, and TCE in the samples of the treated groundwater was determined at the 95 percent confidence level using a one-tailed Student's t-test. For the UCL, data from all the sampling events, except the first Bechtel sampling event were used. The UCL for each of these three VOCs was calculated using the following equation:

$$UCL_{t,95\%} = \bar{x} + t \frac{s}{\sqrt{n}}$$

Where:

- x = Sample mean contaminant concentration
- t = Student's t-test statistic value at the 95 percent confidence level
- s = Sample standard deviation
- n = Sample size (number of measurements)

The following parameters were calculated from the 1,1-DCE, cis-1,2-DCE, and TCE concentration data presented in Table 6.

<u>1,1-DCE</u>	<u>cis-1,2-DCE</u>	<u>TCE</u>
x = 27.19	x = 1,397	x = 31.45
t = 1.943	t = 1.943	t = 1.943
s = 13.09	s = 495	s = 19.31
n = 7	n = 7	n = 7

Given the parameters above, the UCLs at the 95 percent confidence level for 1,1-DCE, cis-1,2-DCE, and TCE in the treated effluent are:

<u>1,1-DCE</u>	<u>cis-1,2-DCE</u>	<u>TCE</u>
37 Fg/L	1,760 Fg/L	46 Fg/L

The MCLs for 1,1-DCE, cis-1,2,-DCE, and TCE are 6 Fg/L, 6 Fg/L, and 5 Fg/L, respectively. MACTEC claims that the NoVOCs™ system can reduce VOC concentrations in groundwater to below MCLs if the

contaminant source has been removed. However, because DNAPLs may be present in the aquifer, MACTEC did not make any claims for reduction of dissolved VOC concentrations in the groundwater.

3.2.1.2 Primary Objective P2

Determine the radial extent of the NoVOCs™ treatment cell.

The original intent of this investigation was to evaluate the radial extent of the NoVOCs™ treatment cell by conducting a series of tracer dye tests. However, because of the sporadic operation of the NoVOCs™ system, the dye trace study was not conducted, and a direct evaluation of the radial extent of the NoVOCs™ treatment cell was not performed. In lieu of the dye trace study, the aquifer pump tests conducted to assess the hydrogeologic characteristics of the site were used to indirectly evaluate the radial extent of the NoVOCs™ treatment cell. Although the aquifer pump tests cannot be directly applied to evaluate the radial extent of the NoVOCs™ treatment cell or even that groundwater recirculation was established, the test data provides information on the radius of influence of the well under pumping (2-dimensional) and dipole (3-dimensional) flow conditions. The resulting changes in pressure head provide an indication of the potential for flow in the surrounding aquifer and are used to provide an estimate of the radial extent of influence created by the NoVOCs™ well. However, the pressure head changes do not accurately represent flow patterns or contaminant transport, and as such, no firm conclusions can be drawn about the radial extent of the NoVOCs™ treatment cell.

A constant discharge rate pumping test was conducted in the shallow aquifer zone to characterize aquifer hydraulic properties by pumping the recharge chamber of the NoVOCs™ well. The constant discharge pumping test data indicate that the shallow aquifer zone is fairly transmissive in the horizontal direction. The upper and lower aquifer zones are also well connected with the vertical hydraulic conductivity approximately one-fifth of the horizontal conductivity value (the anisotropy ratio, K_r/K_v is about 5). During the constant discharge rate ($Q = 20$ gpm) pumping test, measurable drawdowns (± 0.01 feet) were observed at about 100 feet from the NoVOCs™ well in all directions and at different depths. This information indicates that the radius of influence by extraction, specifically at 20 gpm, could be as large as 100 feet.

A dipole flow test, which mimics NoVOCs™ system operation, was conducted to further evaluate the aquifer anisotropy. The dipole flow test was conducted by pumping the lower chamber of the NoVOCs™

well and simultaneously injecting water into the upper chamber. The test was conducted using different extraction and injection rates at different step intervals. The maximum extraction-injection rate used during the test was about 24 gpm. Water level data collected at the 30-foot crossgradient well clusters showed a clear and identifiable rise (drawup) in the shallow zone monitoring well (MW-45) at each step of the test. Pressure responses at each test step were observed in MW-46 and MW-47, which were screened between the pump and injection chamber (MW-46) and lower aquifer zones (MW-47). No measurable drawdown or drawup could be identified in well MW-46. Drawdown in well MW-47 was also insignificant. The 60-foot crossgradient well cluster (MW-48 and MW-49) also showed pressure responses at the beginning of each step in the test. However, drawdowns or drawups were not identified in these wells. Pressure responses to the dipole flow test generally dissipated at 100 feet from the NoVOCs™ well. A small negative pressure pulse and a small positive pressure pulse were recorded in wells MW-52, MW-53, and MW-54 at the beginning and end of the dipole flow test.

In summary, the dipole flow test data shows that measurable pressure responses occur at crossgradient locations 30 feet from the NoVOCs™ well and may be observed at farther distances. However, no drawdowns or drawups were positively identified in monitoring wells beyond the 30-foot distance.

3.2.1.3 Primary Objective P3

Quantify the mass of total VOCs removed from groundwater treated by the NoVOCs™ system over the 6 month evaluation period.

Because of operational problems with the NoVOCs™ system, this objective was not evaluated for the entire 6 month period. The mass removal of VOCs was calculated for the period of April 28 through June 8, 1998, by measuring the air flow rate and concentration of VOCs in air entering and exiting the NoVOCs™ system. The NoVOCs™ system was operational approximately 70 percent of the time during this period, and pumping rates were estimated to range from 10 to 24 gpm. Total VOC concentrations were determined by collecting duplicate, 1-hour integrated air samples using Summa canisters equipped with flow meters from air sampling ports A1 (influent air) and A2 (effluent air) (see Figure 4), and analyzing the samples for VOCs using EPA Method TO-14. The average total VOC concentration of the two duplicate samples was used for each sampling event. Volumetric flow was measured using certified orifice plates installed adjacent to air sampling locations A1 and A2. Air flow rates were collected at the start, middle, and end of the 1-hour sampling period. The three measurements were averaged to calculate

the average hourly flow rate for each sampling event. A total of five air samples and flow rate measurement events were conducted during the demonstration; once per week during the first month (4 events) and one monthly event. Additional samples were not collected because of system operational problems encountered during the demonstration. A summary of the VOCs detected and flow rate measurements collected from A1 and A2 are provided in Tables 7 and 8.

The mass of total VOCs removed during the 1-hour sample collection period was calculated by multiplying the average 1-hour flow rate times the concentration of total VOCs detected during the sampling event, using the following equation:

$$M_v = (Q_{va} \times C) \times \hat{I} t$$

Where:

M_v	=	Mass of total VOCs removed during each sampling event
Q_{va}	=	Average 1-hour volumetric air flow rate measured at the effluent air sampling port A2
C	=	Total VOC concentration as measured from the effluent air sampling port A2
$\hat{I} t$	=	Change in time (1-hour)

Because concentration data were reported in ppb v/v, the data were converted into mass per volume using the Ideal Gas Law, as summarized below:

(1) The Ideal Gas Law was used to calculate the gram moles of air per minute per sample:

$$n_i = \frac{PV_i}{RT}$$

Where:

n_i	=	Gram moles of air per minute for effluent sample collected during event i
P	=	Standard pressure of 1 atmosphere (760 millimeters of mercury)
V_i	=	Flow rate (standard cubic feet per minute) of air measured for effluent sample collected during event i
R	=	Ideal Gas Law: 2.2022
T	=	Standard temperature of 60 EF

TABLE 7

AIR SAMPLE RESULTS – NOVOCs™ INFLUENT SAMPLING PORT A1
NoVOCs™ SITE Demonstration
Site 9, NAS North Island, California

Chemical Parameters	Sampling Event				
	1st Weekly 4/28/98	2nd Weekly 5/6/98	3rd Weekly 5/12/98	4th Weekly 5/21/98	1st Monthly 6/8/98
Volatile Organic Compounds (ppb v/v)					
Benzene	<0.39	<0.44	<0.42	<0.54	<0.47
Chlorobenzene	<0.39	<0.44	<0.42	NA	<0.47
Chloroform	<0.39	<0.44	<0.42	<0.54	<0.47
Dichlorodifluoromethane	0.56	0.52	0.57	0.63	0.60
1,1-Dichloroethene	<0.39	<0.44	<0.42	<0.54	<0.47
Cis-1,2-Dichloroethene	<0.39	<0.44	<0.42	<0.54	<0.47
Tetrachloroethene	<0.39	<0.44	<0.42	<0.54	<0.47
Toluene	<0.39	0.44	<0.42	1.1 B,N	0.57 B
Trichloroethene	<0.39	<0.44	<0.42	<0.54	<0.47
1,1,2-Trichloro-1,2,2-trifluoroethane	<0.39	<0.44	<0.42	<0.54	<0.47
1,2,4-Trimethylbenzene	<0.39	<0.44	<0.42	0.54	<0.47
1,3,5-Trimethylbenzene	<0.39	<0.44	<0.42	<0.54	<0.47
m- and p-Xylenes	<0.39	<0.44	<0.42	<0.54	<0.47
Total VOCs	0.56	0.96	0.57	1.17	1.17 B
Physical Parameters					
Pressure in inches WC	NA	4.85	5.1	4.9	4.5
Flowrate in scfm	60*	69	71	70	67

Notes:

- B Blank contamination, result may be biased high
N Data judged not usable because of indicated data quality problem
< Less than
NA Not analyzed
ppb v/v Parts per billion on a volume per volume basis
scfm Standard cubic feet per minute
VOC Volatile organic compound
WC Water column
* Air flow rate was measured at the NoVOCs™ trailer. All other physical parameters were measured at air sampling location A1

Bolded values are above the reporting limit

TABLE 8

AIR SAMPLE RESULTS – NOVOCS™ EFFLUENT SAMPLING PORT A2
NoVOCS™ SITE Demonstration
Site 9, NAS North Island, California

Chemical Parameters	Sampling Event				
	1st Weekly 4/28/98	2nd Weekly 5/6/98	3rd Weekly 5/12/98	4th Weekly 5/21/98	1st Monthly 6/8/98
Volatile Organic Compounds (ppb v/v)					
Benzene	<260	<1,200	<1,400	<1,300	<1,200
Chlorobenzene	<260	<1,200	<1,400	<1,300	<1,200
Chloroform	<260	<1,200	<1,400	<1,300	<1,200
Dichlorodifluoromethane	<260	<1,200	<1,400	<1,300	<1,200
1,1-Dichloroethene	2,000	13,000	17,000	17,000	12,000
cis-1,2-Dichloroethene	12,000	84,000	100,000	110,000	76,000
Tetrachloroethene	<260	<1,200	<1,400	<1,300	<1,200
Toluene	<260	<1,200	<1,400	<1,300	<1,200
Trichloroethene	500	3,500	4,100	4,200	2,900
1,1,2-Trichloro-1,2,2-trifluoroethane	560	3,600	4,600	4,800	3,000
1,2,4-Trimethylbenzene	<260	<1,200	<1,400	<1,300	<1,200
1,3,5-Trimethylbenzene	<260	<1,200	<1,400	<1,300	<1,200
m- and p-Xylenes	<260	<1,200	<1,400	<1,300	<1,200
Total VOCs	15,060	104,100	125,700	136,000	93,900
Physical Parameters					
Pressure in inches WC	NA	6.1	6.25	5.6	5.0
Flowrate in scfm	60*	68	69	63	61

Notes:

< Less than

NA Not analyzed

ppb v/v Parts per billion on a volume per volume basis

scfm Standard cubic feet per minute

VOC Volatile organic compound

WC Water column

* Air flow rate was measured at the NoVOCS™ trailer. All other physical parameters were measured at air sampling location A2.

Bolded values are above the reporting limit

(2) Gram moles of VOCs per minute were calculated using the value n_i calculated above as follows:

$$\text{Gram moles VOCs per min} = \frac{C_i}{10^9} \times n_i$$

Where:

C_i = Concentration in parts per billion on a volume per volume basis for effluent sample collected during event I

n_i = Gram moles of air per minute for effluent sample collected during event i

(3) Pounds of total VOCs per 1-hour event were calculated using the value for gram moles VOCs per minute calculated above as follows:

$$\text{Total VOC Mass (lb) Per Hour} = \frac{\text{gram moles VOC per min} \times MW_i}{453.59 \text{ grams per pound}} \times \frac{60 \text{ minutes}}{1 \text{ hour}}$$

Where:

MW_i = Molecular weight of VOCs detected in effluent sample collected during event i

Because the concentration of total VOCs in the influent air stream was less than 1 percent of the concentration of total VOCs removed by the system, the mass of total VOCs from the influent air stream is considered to be negligible, and the average mass of total VOCs removed was calculated using the effluent sample results only. The results of the average mass removed during each 1-hour sampling event are summarized in Table 9. During the period from April 28 to June 8, 1998, the average total VOC mass removed by the NoVOCs™ system ranged from 0.01 to 0.14 lb/hr and averaged 0.10 lb/hr during the five sampling events.

A plot of the average mass of total VOCs removed during each sampling event verses time is presented as Figure 28. To determine the total VOC mass removed by the NoVOCs™ system during the period from April 28 through June 8, 1998, a best fit curve was applied to the plotted data and the area under the curve was calculated. Assuming that the 1-hour sampling events were representative of the operating conditions and contaminant concentrations during the period of April 28 through June 8, 1998, the total VOC mass removed was about 90 pounds. However, this method of determining mass overestimates the actual mass removed because it assumes continuous operation of the NoVOCs™ system during the sampling period.

As documented in Section 3.1, the NoVOCs™ system only operated about 70 percent of the time or about 707 hours between April 28 through June 8, 1998.

TABLE 9
SUMMARY OF THE TOTAL VOC MASS REMOVED
EFFLUENT AIR SAMPLING PORT A2
NOVOCS™ SITE Demonstration
Site 9, NAS North Island, California

Effluent Sampling Event (Date)	Effluent Total VOC Concentration Per Event (ppb v/v)	Effluent Air Flow Rate During Event (scfm)	Effluent Total VOC Mass Removed Over 1-Hour Sampling Event (lb/hr)**
1st Weekly (4/28/98)	15,060	60 *	0.01
2nd Weekly (5/6/98)	104,100	68	0.11
3rd Weekly (5/12/98)	125,700	69	0.14
4th Weekly (5/21/98)	136,000	63	0.14
1st Monthly (6/8/98)	93,900	61	0.09
Average	95,000	64.2	0.10

Notes:

- * Flow meter not installed at sample time; measurement obtained from NoVOCs™ trailer
- ** Mass calculated using the Ideal Gas Law, assuming standard sample temperature (60 EF) and pressure (1 atmosphere)
- ppb v/v Parts per billion on a volume per volume basis
- scfm Standard cubic feet per minute
- lb/hr Pounds per hour
- VOC Volatile organic compound

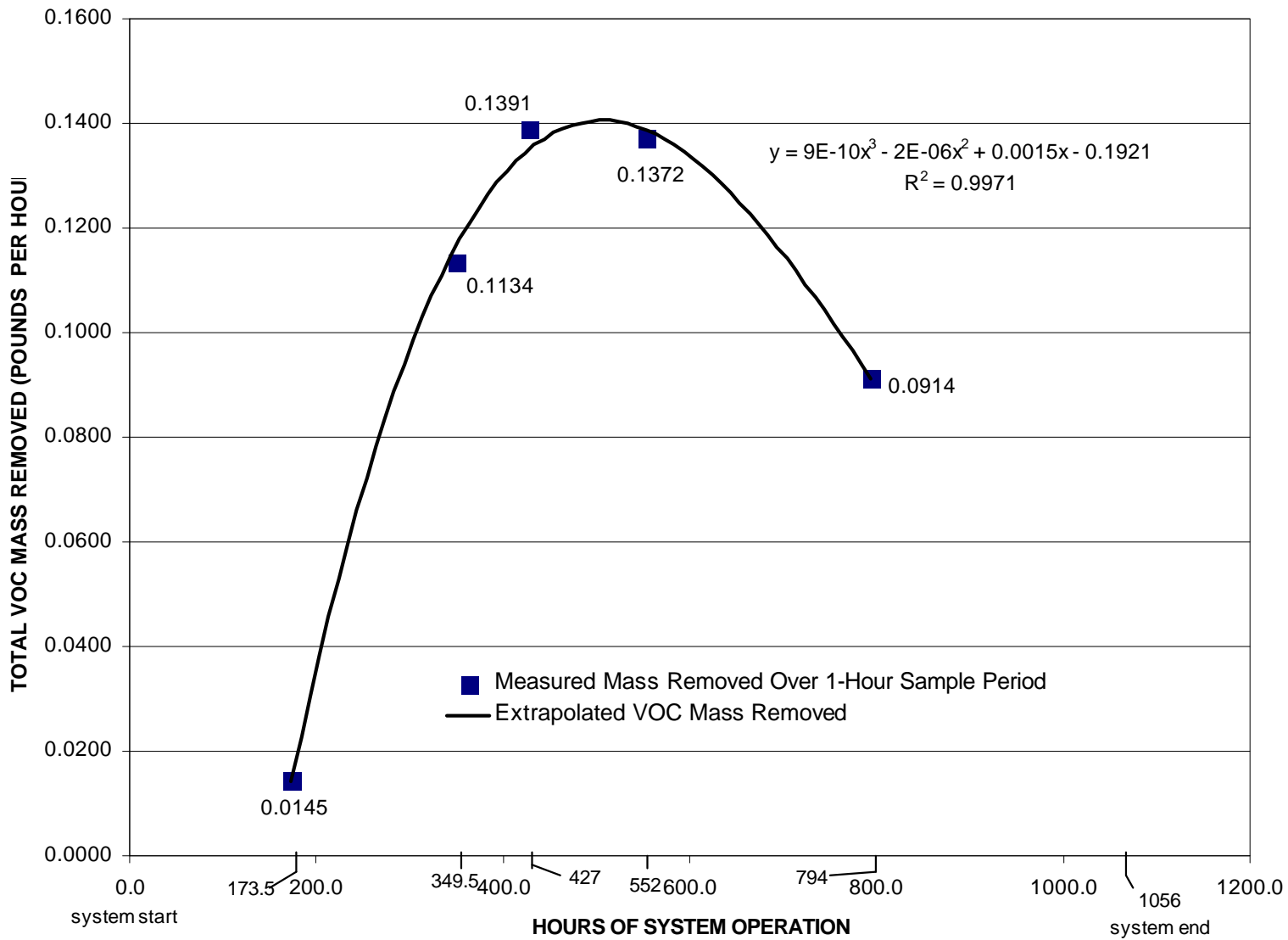

NoVOCs™ SITE Demonstration
 Site 9, NAS North Island, California

FIGURE 28
TOTAL VOC MASS REMOVED
BEST FIT TREND LINE

To account for the sporadic operation of the NoVOCs™ system, the mass of total VOCs removed during the entire operation period from April 20 through June 19, 1998, was calculated by multiplying the average hourly total VOC mass removed during each sampling event times the operation period associated with that period. The mass of total VOCs removed during each of the five sampling events was subsequently summed to calculate the total mass removed during the 61-day operation period. For the total VOC mass removed during the first weekly sampling event, the operation period beginning at system startup on April 20, 1998, to the mid-operational time point between the first and second weekly sampling events was used. Subsequently, the period from the mid-operational time point between the first and second weekly sampling events and the second and third weekly sampling events was used to calculate the total VOC mass removed associated with the average hourly removal rate for the second sampling event. This same procedure was used to determine the operation periods associated with the third and fourth weekly average hourly removal rates. For the first monthly average hourly removal rate, the period beginning at the mid-operational time point between the fourth weekly sampling event and the first monthly sampling event and ending with the shutdown of the NoVOCs™ system on June 19, 1998, was used. A summary of the duration of the operating periods and amount of mass removed during each of the five sampling periods is presented in Figure 29.

Using the method described above, the mass of total VOCs removed during the period of April 20 through June 19, 1998, was calculated to be approximately 92.4 pounds. During this period, the NoVOCs™ system operated a total of 1,056 hours or about 72 percent of the time, and had an average mass removal rate of approximately 0.09 lb/hr or about 2.1 pounds per day of total VOCs.

3.2.2 Secondary Objectives

Secondary objectives provide additional information that is useful, but not critical, for the evaluation of the NoVOCs™ system. Seven secondary objectives were selected for the SITE evaluation of the NoVOCs™ system. The results of each secondary objective are discussed in the following subsections.

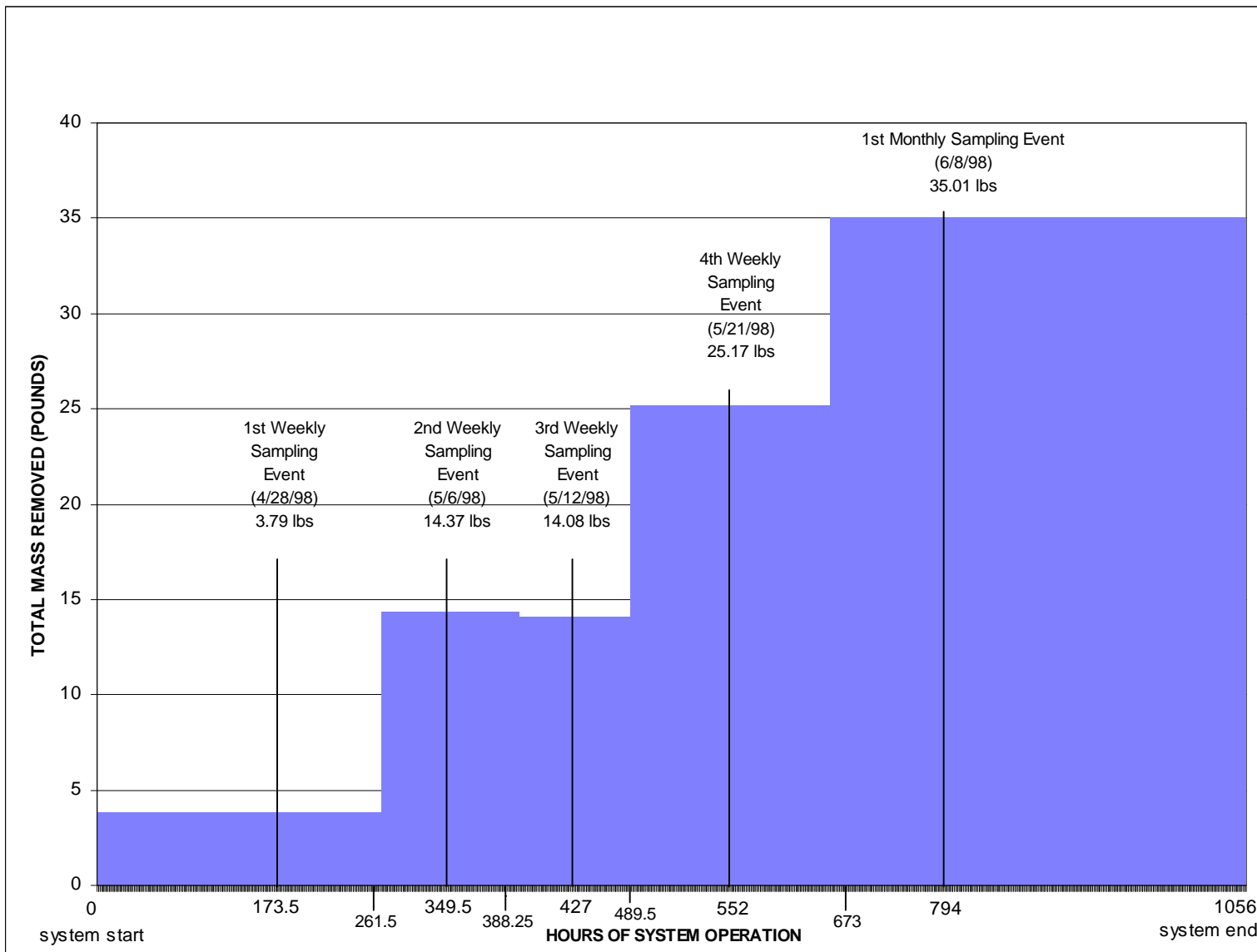

NoVOCs™ SITE Demonstration
 Site 9, NAS North Island, California

FIGURE 29
TOTAL VOC MASS REMOVED
DURING SYSTEM OPERATION

3.2.2.1 Secondary Objective S1

Quantify the changes in VOC concentrations in the groundwater within the NoVOCs™ treatment cell.

This objective was evaluated by collecting groundwater samples from piezometers PZ-01 and PZ-02 and monitoring wells MW-45 through MW-54 and analyzing the samples for VOCs. Because the NoVOCs™ system did not operate continuously over the anticipated demonstration period, groundwater samples were only collected during the baseline, first monthly, and second baseline sampling events. In addition to VOC data collected during the SITE evaluation, VOC data collected by Bechtel from the piezometer and monitoring wells were also documented. The analytical results reported by Bechtel and Tetra Tech for VOCs detected in PZ-01 and PZ-02 and monitoring wells MW-45 through MW-54 are summarized in Tables 10 through 12. Only three VOCs were consistently detected at measurable concentrations during the system demonstration: 1,1-DCE, cis-1,2-DCE, and TCE.

Based on the review of the analytical results, VOC concentrations appear to be stratified in the aquifer. In general, the highest concentrations of the three primary VOCs, 1,1-DCE, cis-1,2-DCE, and TCE were detected in the deep monitoring wells. This trend was especially pronounced for cis-1,2-DCE, which was detected at concentrations between 440 and 96,000 Fg/L in the deep wells, but only between 120 and 1,200 Fg/L in the shallow wells. The intermediate wells generally had the lowest concentration of all three primary VOCs. This pattern of contaminant stratification was confirmed with the data collected with the diffusion multi-layer sampler installed in monitoring well MW-54. Because of the limited amount of data collected during the demonstration and operational problems with the NoVOCs™ system throughout the demonstration, trends in the VOC concentration data associated with operation of the NoVOCs™ system were not apparent.

3.2.2.2 Secondary Objective S2

Document changes in SVOCs and selected geochemical parameters that may be affected by the NoVOCs™ system.

This objective was evaluated by collecting groundwater samples at the beginning and end of the demonstration from piezometers PZ-01 and PZ-02 and monitoring wells MW-45 through MW-54 and

TABLE 10

1,1-DICHLOROETHENE CONCENTRATION SUMMARY
NoVOCs™ SITE Demonstration
Site 9, NAS North Island, California

Well	Description	1,1-Dichloroethene Concentration (Fg/L)										
		Bechtel Baseline 2/6-10/98	Bechtel 3/4/98	Bechtel 3/19/98	Tetra Tech Baseline 4/17/98	Tetra Tech 1st Weekly 4/28/98	Bechtel 4/29/98	Tetra Tech 2nd Weekly 5/6/98	Tetra Tech 3rd Weekly 5/12/98	Tetra Tech 1st Monthly 6/8-10/98	Bechtel 6/8/98	Tetra Tech Baseline 9/8/98
PZ-01	System Recharge	1,500	270	50	36	25	30	16	26	9.3	34	420
PZ-02	System Intake	6,100	2,700	2,800	81	2,300	4,400	2,400	3,100	4,300	5,400	6,100
MW-45	Shallow Well	340	NA	NA	500	NA	NA	NA	NA	930	1,600	850
MW-46	Intermediate Well	470	NA	NA	120	NA	NA	NA	NA	99	200	70
MW-47	Deep Well	10,000	NA	NA	9,300	NA	NA	NA	NA	5,300	7,600	540
MW-48	Shallow Well	430	NA	NA	160	NA	NA	NA	NA	150	260	530
MW-49	Deep Well	700	NA	NA	280	NA	NA	NA	NA	250	270	360
MW-50	Intermediate Well	210	NA	NA	180	NA	NA	NA	NA	25	210	260
MW-51	Intermediate Well	110	NA	NA	93	NA	NA	NA	NA	140	130	120
MW-52	Shallow Well	NA	18	NA	<500	NA	NA	NA	NA	<500	10 J	<360
MW-53	Deep Well	NA	20,000	NA	NA ⁽¹⁾	NA	NA	NA	NA	13,000	14,000	15,000
MW-54	Fully Penetrating Well	NA	NA	NA	NA ⁽²⁾	NA	NA	NA	NA	6,000	NA	5,600

Notes:

J Laboratory qualifier indicating the associated numerical value is an estimated quantity

Fg/L Micrograms per liter

< Less than

NA Not analyzed

⁽¹⁾ Monitoring well MW-53 was not sampled because of a malfunctioning bladder pump.

⁽²⁾ Monitoring well MW-54 was not sampled because of the presence of the multi-level diffusion sampler in the well

Bolded values are above the reporting limit

TABLE 11

CIS-1,2-DICHLOROETHENE CONCENTRATION SUMMARY
NoVOCs™ SITE Demonstration
Site 9, NAS North Island, California

Well	Description	Cis-1,2-Dichloroethene Concentration (Fg/L)										
		Bechtel Baseline 2/6-10/98	Bechtel 3/4/98	Bechtel 3/19/98	Tetra Tech Baseline 4/17/98	Tetra Tech 1st Weekly 4/28/98	Bechtel 4/29/98	Tetra Tech 2nd Weekly 5/6/98	Tetra Tech 3rd Weekly 5/12/98	Tetra Tech 1st Monthly (6/8-10/98)	Bechtel 6/8/98	Tetra Tech Baseline 9/8/98
PZ-01	System Recharge	6,300	6,700	2,100	2,400	1,800	1,500	1,200	1,500	580	1,100	3,800
PZ-02	System Intake	35,000	13,000	40,000	2,600	45,000	52,000	39,000	40,000	46,000	53,000	41,000
MW-45	Shallow Well	560	NA	NA	720	NA	NA	NA	NA	1,000	1,200	1,100
MW-46	Intermediate Well	66	NA	NA	130	NA	NA	NA	NA	3,200	3,800	1,700
MW-47	Deep Well	96,000	NA	NA	86,000	NA	NA	NA	NA	36,000	39,000	7,900
MW-48	Shallow Well	460	NA	NA	640	NA	NA	NA	NA	560	610	510
MW-49	Deep Well	440	NA	NA	2,100	NA	NA	NA	NA	880	840	1,300
MW-50	Intermediate Well	320	NA	NA	230	NA	NA	NA	NA	220	250	240
MW-51	Intermediate Well	180	NA	NA	200	NA	NA	NA	NA	270	290	260
MW-52	Shallow Well	NA	140	NA	120	NA	NA	NA	NA	150	160	250
MW-53	Deep Well	NA	68,000	NA	NA ⁽¹⁾	NA	NA	NA	NA	53,000	56,000	52,000
MW-54	Fully Penetrating Well	NA	NA	NA	NA ⁽²⁾	NA	NA	NA	NA	6,400	NA	38,000

Notes:

Fg/L Micrograms per liter

< Less than

NA Not analyzed

⁽¹⁾ Monitoring well MW-53 was not sampled because of a malfunctioning bladder pump.⁽²⁾ Monitoring well MW-54 was not sampled because of the presence of the multi-level diffusion sampler in the well.

Bolded values are above the reporting limit

TABLE 12

TRICHLOROETHENE CONCENTRATION SUMMARY
NoVOCs™ SITE Demonstration
Site 9, NAS North Island, California

Well	Description	Trichloroethene Concentration (Fg/L)										
		Bechtel Baseline 2/6-10/98	Bechtel 3/4/98	Bechtel 3/19/98	Tetra Tech Baseline 4/17/98	Tetra Tech 1st Weekly 4/28/98	Bechtel 4/29/98	Tetra Tech 2nd Weekly 5/6/98	Tetra Tech 3rd Weekly 5/12/98	Tetra Tech 1st Monthly (6/8-10/98)	Bechtel 6/8/98	Tetra Tech Baseline 9/8/98
PZ-01	System Recharge	3,600	190	65	53	50	25	26	27	9.2	18	330
PZ-02	System Intake	740	790	1,300	120	760	1,600	1,900	2,000	2,300	1,700	7,800
MW-45	Shallow Well	10,000	NA	NA	11,000	NA	NA	NA	NA	<330	13,000	10,000
MW-46	Intermediate Well	1,300 E	NA	NA	1,800	NA	NA	NA	NA	770	950	550
MW-47	Deep Well	4,800	NA	NA	5,700	NA	NA	NA	NA	17,000	20,000	95
MW-48	Shallow Well	3,400	NA	NA	2,900	NA	NA	NA	NA	3,300	3,800	2,700
MW-49	Deep Well	7,900	NA	NA	2,400	NA	NA	NA	NA	1,200	1,300	1,700
MW-50	Intermediate Well	2,300	NA	NA	1,100	NA	NA	NA	NA	170	790	1,200
MW-51	Intermediate Well	3,300	NA	NA	3,200	NA	NA	NA	NA	<100	3,700	3,900
MW-52	Shallow Well	NA	4,800	NA	7,000	NA	NA	NA	NA	8,200	5,200	6,400
MW-53	Deep Well	NA	6,000	NA	NA ⁽¹⁾	NA	NA	NA	NA	2,100	2,100	1,200
MW-54	Fully Penetrating Well	NA	NA	NA	NA ⁽²⁾	NA	NA	NA	NA	740	NA	1,400

Notes:

D Laboratory qualifier identifies compounds in an analysis at a secondary dilution

E Value estimated because of interference

Fg/L Micrograms per liter

< Less than

NA Not analyzed

⁽¹⁾ Monitoring well MW-53 was not sampled because of a malfunctioning bladder pump.

⁽²⁾ Monitoring well MW-54 was not sampled because of the presence of the multi-level diffusion sampler in the well.

analyzing the samples for SVOCs, dissolved metals, dissolved organic carbon, alkalinity, and total dissolved solids. In addition, groundwater samples were collected during the weekly sampling events from PZ-01 and PZ-02 and the monthly event from PZ-01 and PZ-02 and monitoring wells MW-45 through MW-54. These samples were analyzed for dissolved oxygen, oxidation/reduction potential, temperature, specific conductance, salinity, and pH. The results documenting SVOC concentrations and the selected geochemical characteristics are presented in Volume I, Appendix A as Tables A3 through A35, and are discussed below.

The only SVOC detected on a consistent basis was 1,2-dichlorobenzene. Based on the review of the 1,2-dichlorobenzene concentration data, no clear trends were identified that indicated that contaminant concentrations were affected by the operation of the NoVOCs™ system.

Despite the possible iron fouling problems experience in the NoVOCs™ well, the groundwater analytical results for dissolved metals exhibited no clear trends in the data to indicate the precipitation of dissolved metals was occurring in the aquifer. Alkalinity, total organic carbon, and dissolved organic carbon results remained relatively unchanged during the demonstration. Total dissolved solid concentrations showed an increasing trend with depth; however, concentrations did not appear to be affected by operation of the NoVOCs™ system. Conductivity and salinity values measured in the field also increased with depth and appeared to correlate with the analytical results for total dissolved solids. No clear trends were apparent from the field measurements of temperature, pH, and dissolved oxygen, and insufficient data were collected to adequately evaluate trends associated with oxidation/reduction potential.

In addition to the select geochemical parameters analyzed during collection of groundwater samples, water quality parameters, including temperature, specific conductance, pH, oxidation/reduction potential, dissolved oxygen, salinity, and turbidity were measured in water from the pump discharge line during the pumping tests. A summary of the water quality parameter measurements is provided in the Hydrogeologic Investigation of the Aquifer Treated by the NoVOCs™ System (Tetra Tech 2000), which is provided as Volume I, Appendix C. In general, results for the water quality parameters have higher values in the lower screened zone, with the exception of pH and temperature. This finding was also supported for the VOC concentration data from the wells at the demonstration site, which exhibit higher concentrations in samples from the deep wells than in samples from the shallow wells.

Specific conductance and salinity values measured during pumping of the upper screened interval averaged 22.2 micromhos per centimeter (Fmhos/cm) and 2.26 percent, respectively, while the same parameters measured during pumping of the lower screen interval averaged 27.4 Fmhos/cm and 2.71 percent. These results are consistent with the range of values and trend toward increased specific conductance and salinity with depth. Average temperature measured while pumping the upper and lower screened intervals was about 21.7 EC. Results of pH measurements while pumping the upper screened interval averaged 7.40, which was higher than the average pH value of 7.03 calculated from measurements collected when pumping the lower screened interval. The average oxidation/reduction potential in the upper interval was 22.7 millivolts (mV), while the average oxidation/reduction potential (Eh) in the lower interval was minus 30.5 mV. Dissolved oxygen concentrations remained relatively unchanged between the two screened intervals.

3.2.2.3 Secondary Objective S3

Document NoVOCs™ system operating parameters.

The following process data were provided by Bechtel:

- Air temperature measurement at the well air intake, after the blower and before injection into the well
- Pressure measurement after the blower and before injection into the well
- Linear flow velocity measurement after the blower and before injection into the well
- Well pumping rate measurement using an in-well flow sensor
- Groundwater pH measurement in the well effluent

A summary of the system operating parameter results is shown in Table 13.

TABLE 13

**NoVOCs™ SYSTEM OPERATING PARAMETERS
NoVOCs™ SITE Demonstration
Site 9, NAS North Island, California**

Operating Period	Dates of Operation	Well Air Intake						Well		Well Effluent	
		Temperature (EF)		Pressure (psi)		Air Flow (scfm)		Pumping Rate (gpm)		pH	
		Mean	Range	Mean	Range	Mean	Range	Mean	Range	Mean	Range
Startup and Shakedown Operation	February 26 through March 26, 1998	145	103 to 180	2.8	2.2 to 3.6	66.7	40 to 120	22.2	8 to 34	7.28	5.36 to 12.35
Early Operation	April 20 through June 19, 1998	132	66 to 184	3.3	3.0 to 3.6	55.8	51 to 65	15.0	10 to 24	6.54	1.23 to 7.76
Reconfiguration Operation	September 24 through October 30, 1998	152	120 to 173	2.8	2.5 to 3.3	69.0	35 to 90	18.4	14 to 22	7.10	6.40 to 7.62
Final Configuration Operation	December 1, 1998 through January 4, 1999	136	119 to 150	3.0	3.0 to 3.0	52.4	50 to 55	NR	NR	3.60	1.25 to 7.5

Notes:

- psi Pounds per square inch
- scfm Standard cubic feet per minute
- gpm Gallons per minute
- NR Not reported

3.2.2.4 Secondary Objective S4

Document pre- and post-treatment VOC concentrations and system operating parameters in the Thermatrix flameless oxidation offgas treatment system.

This objective was evaluated by collecting duplicate, 1-hour integrated air samples from sampling ports A3 (pretreatment) and A4 (post-treatment) and analyzing samples for VOCs using EPA Method TO-14.

In addition to pre- and post-treatment VOC concentrations, air flow rate, vacuum, and temperature were recorded at sampling ports A3 and A4 (see Figure 4). A total of five air sampling and flow rate measurement events were conducted during the demonstration; once per week during the first month (four events) and one monthly event. Additional samples were not collected because of system operational problems encountered during the demonstration. A summary of the VOCs detected and flow rate measurements collected from air sampling ports A3 and A4 are provided in Tables 14 and 15, respectively.

Based on a comparison of influent and effluent samples collected from the Thermatrix system, total VOC concentrations in the 1-hour composite samples collected from the influent air sampling port (A3) ranged from 22,120 to 59,200 ppb v/v and averaged 45,200 ppb v/v during the five sampling events. Total VOC concentrations in the 1-hour composite samples collected from the effluent air sampling port (A4) ranged from 2.8 to 7.2 ppb v/v and averaged 4.8 ppb v/v during the five sampling events. Total VOCs concentrations measured in the influent sampling port were reduced by greater than 99.9 percent in all five sampling events.

3.2.2.5 Secondary Objective S5

Document the hydrogeologic characteristics at the treatment site.

This objective was evaluated by conducting a series of aquifer tests at the demonstration site from July 27 through August 5, 1998, to obtain information on hydraulic communication between various zones of the aquifer beneath the site, as well as data for estimating values of aquifer hydraulic parameters such as hydraulic conductivity, transmissivity, storativity, specific yield, and anisotropy. In addition, the aquifer

TABLE 14

AIR SAMPLE RESULTS – THERMATRIX INFLUENT SAMPLING PORT A3
NoVOCS™ SITE Demonstration
Site 9, NAS North Island, California

Chemical Parameters	Sampling Event				
	1st Weekly 4/28/98	2nd Weekly 5/6/98	3rd Weekly 5/12/98	4th Weekly 5/21/98	1st Monthly 6/8/98
Volatile Organic Compounds (ppb v/v)					
Benzene	<1,100	<760	<1,100	<760	<1,100
Chlorobenzene	<1,100	<760	<1,100	<760	<1,100
Chloroform	<1,100	<760	<1,100	<760	<1,100
Dichlorodifluoromethane	<1,100	<760	<1,100	<760	<1,100
1,1-Dichloroethene	7,900	5,600	7,600	4,800	2,700
Cis-1,2-Dichloroethene	47,000	37,000	48,000	32,000	18,000
Tetrachloroethene	<1,100	<760	<1,100	<760	<1,100
Toluene	<1,100	<760	<1,100	<760	<1,100
Trichloroethene	2,000	1,500	1,900	1,200	680
1,1,2-Trichloro-1,2,2-trifluoroethane	2,300	1,500	2,200	1,400	740
1,2,4-Trimethylbenzene	<1,100	<760	<1,100	<760	<1,100
1,3,5-Trimethylbenzene	<1,100	<760	<1,100	<760	<1,100
m- and p-Xylenes	<1,100	<760	<1,100	<760	<1,100
Total VOCs	59,200	45,600	59,700	39,400	22,120
Physical Parameters					
Pressure in inches WC	NA	25.3	24.5	22	21
Flowrate in scfm	NA	58	60	NA	61

Notes:

< Less than

NA Not analyzed

ppb v/v Parts per billion on a volume per volume basis

scfm Standard cubic feet per minute

VOC Volatile organic compounds

WC Water column

Bolded values are above the reporting limit

TABLE 15

AIR SAMPLE RESULTS – THERMATRIX EFFLUENT SAMPLING PORT A4
NoVOCS™ SITE Demonstration
Site 9, NAS North Island, California

Chemical Parameters	Sampling Event				
	1st Weekly 4/28/98	2nd Weekly 5/6/98	3rd Weekly 5/12/98	4th Weekly 5/21/98	1st Monthly 6/8/98
Volatile Organic Compounds (ppb v/v)					
Benzene	<6.6	0.88 B, N	<1.2	<0.63	<0.51
Chlorobenzene	<6.6	1.1 B, N	<1.2	<0.63	<0.51
Chloroform	1.0	1.9	<1.2	3.9	3.4 B
Dichlorodifluoromethane	<6.6	<0.54	<1.2	<0.63	<0.51
1,1-Dichloroethene	<6.6	<0.54	<1.2	<0.63	<0.51
Cis-1,2-Dichloroethene	<6.6	<0.54	<1.2	<0.63	2.4 B, N
Tetrachloroethene	97 B, N	<0.54	<1.2	<0.63	<0.51
Toluene	6.2	1.8 B, N	3.3 B, N	2.4 B, N	0.80 B, N
Trichloroethene	<6.6	<0.54	<1.2	<0.63	<0.51
1,1,2-Trichloro-1,2,2-trifluoroethane	<6.6	<0.54	<1.2	<0.63	<0.51
1,2,4-Trimethylbenzene	<6.6	2.8	0.95	<0.63	<0.51
1,3,5-Trimethylbenzene	<6.6	1.1	<1.2	<0.63	<0.51
m- and p-Xylenes	<6.6	1.1	1.8	0.93 B, N	<0.51
Total VOCs	7.2 B	6.9	2.8	3.9	3.4 B
Physical Parameters					
Pressure in inches WC	NA	NA	NA	NA	NA
Flowrate in scfm	NA	NA	NA	NA	NA

Notes:

- B Blank contamination; result may be biased high
N Data judged not usable due to indicated data quality problem
< Less than
NA Not analyzed
ppb v/v Parts per billion on a volume per volume basis
scfm Standard cubic feet per minute
VOC Volatile organic compounds
WC Water column
Bolded values are above the reporting limit

tests were conducted to obtain data for calculating well efficiencies for the two screened intervals of the NoVOCs™ well.

Aquifer testing was conducted using the NoVOCs™ well (IW-01) as the pumping or injection well. Two piezometers and 10 observation wells were available for water level measurements. An inflatable packer was used to isolate the two screened intervals within the NoVOCs™ well to allow pumping from each screened interval separately. The aquifer tests, in the order conducted, were as follows:

- C Step drawdown test in the upper screened interval conducted on July 27, 1998
- C A 32-hour constant discharge pumping test in the upper screened interval conducted on July 28 and 29, 1998
- C Injection test in the upper screened interval conducted on July 31, 1998
- C Step drawdown test in the lower screened interval conducted on August 1, 1998
- C Dipole flow test with pumping in the lower screened interval and injection in the upper screened interval conducted on August 5, 1998

A constant discharge pumping test for the lower screened interval was not conducted because of the excessive volume of water that would be generated and the prohibitive cost of water disposal. A detailed description of the methods, procedures, results, and interpretation of the hydrogeologic study is presented in the Hydrogeological Investigation Report of the Aquifer Treated by the NoVOCs™ System (Tetra Tech 2000), which is provided as Volume I, Appendix C. The conclusions of the hydrogeologic study are summarized below.

- C Groundwater generally flows to the west or northwest in both of the upper and lower aquifer zones. The horizontal hydraulic gradient in both aquifer zones is relatively flat, ranging from 0.005 to 0.01.
- C Aquifer hydraulic parameters are estimated based on the tidally corrected groundwater drawdown data for the constant discharge pumping test conducted at the upper well screen. The average hydraulic conductivity is 29 ft/day or 0.01 cm/sec. The average aquifer storativity and specific yield are 0.004 and 0.07, respectively. The average ratio of horizontal to vertical hydraulic conductivity is 5.7.
- C Specific capacity and efficiency of the NoVOCs™ well are estimated based on the step-drawdown tests and water injection test conducted at the NoVOCs™ well. The calculated average specific capacities are 1.48 gallons per minute per foot (gpm/ft) for the upper screened

interval during pumping, 1.50 gpm/ft for the upper screened interval during injection, and 3.22 gpm/ft for the lower screened interval during pumping. The calculated average well efficiencies are 82 percent for the upper screened interval during pumping, 97 percent for the upper screened interval during injection, and 91 percent for the lower screened interval during pumping. The 97 percent well efficiency for the upper screened injection is for injection of clean tap water.

- C The radius of influence during the constant discharge pumping test (20 gpm) is at least 100 feet based on the drawdown measured at the observation wells.
- C The injection test results show that the maximum flow of clean tap water that can be injected through the upper screen of the NoVOCs™ well is 25 gpm. At that injection rate, the water level will rise 17 feet and reach the ground surface.
- C The findings of the aquifer tests and tidal study of the aquifer treated by the NoVOCs™ system indicate that the aquifer hydraulic conditions are suitable for application of the NoVOCs™ technology. The NoVOCs™ well as designed should be able to extract and inject a flow rate of 20 gpm based on the aquifer hydraulic characteristics.

3.2.2.6 Secondary Objective S6

Document the changes in pressure head in the aquifer caused by the NoVOCs™ system.

This objective was achieved by conducting a tidal influence study from April 20 through 30, 1998, to measure natural fluctuations in water level at the site caused by tidal influences and water level changes in the aquifer caused by NoVOCs™ system operation. A description of the methods and procedures used to conduct the tidal study is presented in the Hydrogeological Investigation of the Aquifer Treated by the NoVOCs™ System (Tetra Tech 2000), which is provided as Volume I, Appendix C. The results of the study are summarized below.

Maximum groundwater level fluctuations measured in the observation wells ranged from 0.56 to 0.73 feet, depending on the location of the observation well. The amplitudes of the tidal fluctuations in water levels were highest for observation wells closest to San Diego Bay (MW-52 and MW-53). The other observation wells monitored during the tidal influence study (MW-45 through MW-51) are all located at approximately the same distance from San Diego Bay; the amplitudes of the tidal fluctuations in these wells are similar.

The cyclical pattern of groundwater level fluctuation can be seen for all observation wells and correlates with published tide charts for San Diego Bay with a time lag ranging from about 46 to 96 minutes,

depending on observation well location and magnitude of the tidal fluctuation. The time lag also depends on the degree of hydraulic communication between the bay and the wells. The range of time lags is similar for each of the observation wells because of the similar distance relative to San Diego Bay. The aquifer zone is generally in good hydraulic communication with the San Diego Bay.

Groundwater level changes caused by startup and shutdown of the NoVOCs™ system on April 20, 1998, are evident in the water level data for well cluster MW-45, MW-46, and MW-47, located about 30 feet from the NoVOCs™ well. The water level data for observation wells MW-45 (the upper screened well in this cluster) and MW-46 (intermediate screened well) show water level increases after system startup. The groundwater elevation increase in well MW-45 was approximately 0.15 feet of water. Observation well MW-46, the intermediate depth well, shows a water level increase of approximately 0.05 feet of water. Observation well MW-47, the deep screened well, shows a water level decrease of approximately 0.025 feet. This pattern of water level increases and decreases associated with the operation of the NoVOCs™ system is expected based on the monitoring well screen locations relative to the NoVOCs™ well screen locations. The deep screened well experienced a drop in water level as water was drawn toward the NoVOCs™ well intake, and the upper screened wells experienced increases in water level as water was lifted inside of the NoVOCs™ well, and discharged into the upper aquifer. In well pair MW-48 and MW-49 (located about 62 feet from the NoVOCs™ well) and in wells MW-50 and MW-51 (located about 91 and 105 feet, respectively, from the NoVOCs™ well), water level changes associated with NoVOCs™ system operation were not apparent. Similar results were observed during the dipole test conducted in August 1998.

3.2.2.7 Secondary Objective S7

Estimate the capital and operating costs of the NoVOCs™ system and Thermatrix flameless oxidation process for the 6 month evaluation.

This objective was evaluated by using capital and operating and maintenance cost information provided by the Navy and MACTEC and by estimating labor requirements. A detailed estimate of the costs of installing and operating a single NoVOCs™ well to treat groundwater contaminated with VOCs is presented in Section 4.0.

3.3 DATA QUALITY

This section summarizes the data quality for groundwater and air samples collected and analyzed during the NoVOCs™ technology demonstration. This data quality assessment was conducted to evaluate the impact of all QC measures on the overall data quality, and remove all unusable values from the investigation data set. The results of this assessment were used to produce the known, defensible information employed to define the investigation findings and draw conclusions.

Both field QC samples and laboratory QC analyses were analyzed. Field samples included equipment blanks, field blanks, and trip blanks. Laboratory samples included method blanks, surrogate recoveries, initial and continuing calibration, matrix spike/matrix spike duplicates, and samples/sample duplicates. Results from these samples were used to evaluate the precision and accuracy of the data.

Summaries of analytical QC data are provided in Volume VI, Appendix F. In general, all data quality indicators met the QA objectives specified in the TEP/QAPP (Tetra Tech 1998) for the NoVOCs™ technology demonstration, indicating that general data quality was good and that the sample data are useable as reported. The data quality indicators associated with the baseline, first, second, third, and fourth weekly, first monthly, and second baseline sampling events met the acceptance criteria specified in the QAPP (Tetra Tech 1998). Data quality outliers from the other sampling events are identified and discussed in Table 16. None of the outliers discussed in Table 16 were determined to inhibit the overall usefulness of the demonstration data in evaluating the demonstration project objectives.

Additionally, QC control charts of precision and accuracy for VOCs, as determined by matrix spike (MS) recoveries and matrix spike/matrix spike duplicates (MS/MSD) RPDs, were prepared to assess potential trends in analytical system bias. These charts did not reveal noticeable trends in system bias, suggesting that trends noted from demonstration data are due to contaminant concentration changes in the environmental media sampled.

TABLE 16

**DATA QUALITY OUTLIERS
NoVOCs™ SITE Demonstration
Site 9, NAS North Island, California**

Sampling Event	Data Quality Outlier	Impact on Data Quality
Critical Parameters		
Baseline	Several groundwater samples required dilution to bring high concentration analytes (particularly cis-1,2-dichloroethene) into the calibration range of the instrument.	The dilutions resulted in elevated detection limits for other analytes, but this occurrence was anticipated in the QAPP, and an undiluted sample was run if such an analysis appeared to be warranted to achieve lower detection limits.
	Method blanks and the trip blank revealed persistent low-level contamination (below the laboratory reporting limit) of methylene chloride, a common laboratory solvent.	Sample results were flagged with respect to the observed concentrations of methylene chloride. Because methylene chloride was not a significant fraction of the total measured chlorinated hydrocarbons in any of the contaminated groundwater samples and is not a critical analyte, the potential high bias of the methylene chloride results should not affect overall project objectives.
First Weekly	Tetrachloroethene contamination was observed in the field blank at a significant level. Tetrachloroethene was also detected once in the Thermatrix stack gas (Location A4), even though it was not detected in the influent to the Thermatrix system (Location A3) or in the groundwater passing through the NoVOCs™ system (Locations A1 and A2).	The one tetrachloroethene measurement in the Thermatrix stack gas has been flagged because it may reflect sample contamination.

TABLE 16 (Continued)

**DATA QUALITY OUTLIERS
NoVOCs™ SITE Demonstration
Site 9, NAS North Island, California**

Sampling Event	Data Quality Outlier	Impact on Data Quality
First Weekly	Method blanks and the trip blank revealed persistent trace level contamination (below the laboratory reporting limit) of methylene chloride, a common laboratory solvent.	Sample results were flagged with respect to the observed concentrations of methylene chloride. Because methylene chloride was not a significant fraction of the total measured chlorinated hydrocarbons in any of the contaminated groundwater samples, the potential high bias of the methylene chloride results should not affect overall project objectives.
Third Weekly	Small quantities of BTEX were observed in the field blank.	Because BTEX compounds were observed only in the Thermatrix effluent vapor (sampling location A4) and not in the Thermatrix influent vapor (sampling locations A2 and A3), it appears that BTEX concentrations in the A4 sample may be related to either field contamination or to improper cleaning of summa canisters. These results have been flagged and will not be used in the data analysis.
Fourth Weekly	Small quantities of BTEX compounds were observed in the field blank.	Because BTEX compounds were observed above the reporting limit in the Thermatrix effluent vapor (sampling location A4) and influent air (sampling location A1) but not in the Thermatrix influent vapor (sampling locations A2 and A3), it appears that BTEX concentrations in the A4 and A1 samples may be related to either field contamination or more specifically to improper cleaning of summa canisters. These results have been flagged and will not be used in the data analysis.

TABLE 16 (Continued)

**DATA QUALITY OUTLIERS
NoVOCs™ SITE Demonstration
Site 9, NAS North Island, California**

Sampling Event	Data Quality Outlier	Impact on Data Quality
First Monthly	Small quantities of several critical BTEX analytes (benzene, toluene, and xylenes) and chlorinated hydrocarbons (cis-1,2-dichloroethene and tetrachloroethene) were observed in the field blank.	This was likely due to insufficient cleaning of Summa canisters at the laboratory prior to the sampling event. Because the contaminants were detected in the field blank at concentrations well below the detection limits of the high level samples (A2 and A3), this should have no significant impact on data quality for these samples. However, results for any of these compounds that were detected in the low-level samples (A1 and A4) have been flagged with a B, noting that the reported result may be biased high due to blank contamination. Removal efficiencies that will be calculated for the Thermochem combustion system may therefore be biased low. However, preliminary calculations indicate that these removal efficiencies will be greater than 99 percent, so that the impact of low-level field blank contamination is relatively minor.
Non-Critical Parameters		
Baseline	Matrix spike results for the metals analysis revealed some recoveries outside of the laboratory's control limits.	No QA objectives for accuracy or precision were set in the QAPP for this noncritical analysis. In addition, the few exceptions to the laboratory's QC acceptance criteria were minor deviations or appeared to involve low spike levels relative to background metal concentrations. Therefore, no qualifications of this data appear to be warranted.

4.0 ECONOMIC ANALYSIS

This section presents an economic analysis of the NoVOCs™ technology for treating groundwater contaminated with VOCs. The economic analysis is based on assumptions and cost data provided by the Navy and MACTEC and on the results and experience gained from the SITE evaluation that was conducted at NAS North Island, Site 9. Some cost assumptions are based on previous experience with economic analyses for demonstrations involving similar groundwater circulation wells evaluated under the SITE Program. Costs for the economic analysis have been assigned to one of 12 categories applicable to cleanup activities at Superfund and Resource Conservation and Recovery Act (RCRA) sites (Evans 1990). This section provides a discussion of each category, including general and specific impacts on the overall cost and the assumptions used in the economic analysis.

The MACTEC NoVOCs™ system is applicable principally to groundwater contaminated with VOCs such as solvents and gasoline. A number of factors could affect the cost of treatment, including soil type; contaminant type and concentration; depth to groundwater; site geology and hydrology; groundwater geochemistry; site size and accessibility; required support facilities and available utilities; and treatment goals. It is important to characterize the site thoroughly and properly before implementing this technology to ensure that treatment is focused on contaminated areas and to determine the zone of influence for the well and the number of wells needed to remediate a particular site. Site characterization costs may be substantial, but are not included in this cost analysis.

An economic analysis for treating a portion of the aquifer with a single NoVOCs™ well located immediately downgradient of a contaminant source area was conducted, assuming site conditions and technology performance similar to those encountered during the SITE demonstration at NAS North Island, Site 9. Costs are presented in this economic analysis are in 1999 dollars and are considered to be order-of-magnitude estimates, with an accuracy of plus 50 percent and minus 30 percent.

4.1 BASIS OF ECONOMIC ANALYSIS

This section describes the factors that affect the costs associated with the NoVOCs™ system and presents the assumptions used in this economic analysis. A number of factors affect the estimated costs

of treating groundwater with the NoVOCs™ system, including (1) operating, maintenance, and monitoring factors and (2) site conditions and system design.

4.1.1 Operating, Maintenance, and Monitoring Factors

Operating, maintenance, and monitoring costs are highly variable because of the site-specific and time-dependent nature of NoVOCs™ operation required to remediate a site. The duration of operation for the remediation of a site using the NoVOCs™ system depends on a number of factors, including: (1) the mass and physical characteristics of contaminants present, (2) efficiency of the NoVOCs™ system in removing specific contaminants, (3) site treatment goals, and (4) the aquifer hydrogeologic characteristics. These factors are discussed in detail below.

The mass and physical characteristics of the contaminants in the aquifer to be remediated affect the operation time by influencing the exchange of contaminants from the dissolved to vapor phase. Groundwater with high concentrations of contaminants and contaminants in phases other than the dissolved phase may require multiple passes of recirculated water through the treatment system to meet the target treatment concentration goals. The increased time needed for multiple passes through the treatment system will increase the total cost of operation, maintenance, and monitoring.

The treatment efficiency of each NoVOCs™ well system is dependent on adjustments to design factors (such as air to water ratio). Systems that are not properly adjusted will not achieve maximum efficiency in removing contaminants. Compounds with low removal efficiencies or high influent concentrations may require multiple passes through the treatment system to meet target treatment concentration goals. Again, the increased time needed for multiple passes through the treatment system will increase the total cost of operation, maintenance, and monitoring.

Aquifer hydrogeologic characteristics affect the operation time by controlling (1) the extent of the circulation cell and capture zone, (2) the amount of water that can be pumped through the treatment system per unit time, and (3) the amount of recirculated water passing through the system. The extent of the circulation cell and capture zone is primarily affected by the anisotropy of the aquifer; the ratio of the hydraulic conductivity in the horizontal direction to that in the vertical direction. Anisotropic conditions within the aquifer will result in differences in hydraulic conductivity and groundwater flow within the

aquifer. A NoVOCs™ well installed within an aquifer with a high anisotropy ratio will typically have a larger zone of influence radius than an aquifer with a low anisotropy. Additionally, aquifers with low horizontal hydraulic conductivity may require the NoVOCs™ system to operate at a reduced pumping rate. Furthermore, an aquifer with a low anisotropy ratio typically has a high degree of recirculation through the system and a smaller percentage of untreated water entering the system. Aquifers with high anisotropy ratios typically have a low degree of recirculation through the system and a larger percentage of untreated water entering the system. The vendor reports typical recirculation amounts of treated water ranging from 60 to 90 percent. A small zone of influence may require multiple treatment wells to be installed if the aerial extent of contamination exceeds the zone of influence, and high degrees of recirculation may increase the operation time required to remediate an aquifer. Extra treatment wells and extended treatment time will increase the total cost of the operation, maintenance, and monitoring.

Routine maintenance inspections of the NoVOCs™ system are recommended at least once a week. System maintenance may be increased during the initial startup phase of operation to ensure that the system is working properly. After the initial startup period, however, the vendor claims that no daily requirements for operation and maintenance exist.

Requirements for monitoring the system's performance will vary between sites. Most sites will require monitoring of the treated and untreated groundwater, the system's effluent air stream, and the groundwater in surrounding monitoring wells.

4.1.2 Site Conditions and System Design Factors

The number of NoVOCs™ systems employed at the site will affect the duration and cost of a groundwater remediation project. The need to use more than one treatment system is determined based on site conditions. This analysis assumes that only one NoVOCs™ system will be installed to treat groundwater contaminated with VOCs.

Typically, system design costs for Superfund sites include site preparation (such as removal of debris), construction activities (such as access roads), and site characterization. These costs are not included in this analysis because they are assumed to have been incurred while characterizing the extent of groundwater contamination. However, additional costs incurred for site preparation, construction, and

monitoring well installation activities specifically associated with installation and monitoring of the NoVOCs™ system are included in the economic analysis.

Assumptions for site conditions and system design include the following:

- The site is a Superfund site with PCE-, TCE-, 1,1-DCE-, and BTEX-contaminated groundwater.
- The aquifer has been characterized during previous investigations.
- Suitable site access roads exist.
- Utility supply lines, such as electricity and telephone lines, exist on site.
- A single, 8-inch-diameter NoVOCs™ system will be used for treatment.
- The treatment system will be install at a depth of 80 feet bgs and will operate automatically.
- Contaminated groundwater is located in a shallow aquifer no more than 40 feet bgs.
- The saturated zone has a depth of about 40 feet.
- The flow rate through the NoVOCs™ system is 20 gpm.
- The unit operates 95 percent of the time with only 5 percent downtime for maintenance and repairs.
- Operation and maintenance requires two field technicians to be on site 1 day a week, 8 hours a day.
- One technician is required to collect all required samples and perform minor equipment repairs at the same frequency used for maintenance.
- Untreated and treated groundwater and air samples will be collected from the NoVOCs™ well once per week for the first month and monthly thereafter. In addition, a total of 50 groundwater and air samples will be collected during system startup and shakedown.
- Eight groundwater monitoring wells will be installed to monitor the system's effect on the aquifer. Four of the wells will be installed to a depth of 40 feet bgs, and four wells will be installed at a depth of 80 feet bgs. The wells will be sampled quarterly.
- Only routine maintenance will be required. Labor, materials, and equipment costs associated with major repairs will not be incurred.
- An activated carbon offgas treatment system will be used to treat the air effluent generated by the NoVOCs™ system.

- Because of the nature of the NoVOCs™ technology, no site cleanup or restoration activities would be required during demobilization, except for well plugging and dismantling the offgas treatment unit.
- Because of the variable nature of the time required to remediate a site, annual operation and maintenance costs have been presented for operating the NoVOCs™ system for 1, 3, 5, and 10 years.

4.2 COST CATEGORIES

Cost data associated with the NoVOCs™ technology have been assigned to the following 12 categories: (1) site preparation; (2) permitting and regulatory requirements; (3) equipment; (4) startup; (5) labor; (6) consumables and supplies; (7) utilities; (8) effluent treatment and disposal; (9) residuals and waste shipping and handling; (10) analytical services; (11) maintenance and modifications; and (12) demobilization. Using the general assumptions already discussed, a breakdown of costs into the 12 categories is presented in Table 17. The assumptions used for each specific cost factor are discussed in more detail below.

4.2.1 Site Preparation Costs

Preliminary site preparation activities are generally highly specific, depending on a number of factors. For this analysis, generic site preparation activities, such as site design and layout, surveys and site logistics, legal searches, access rights, and roads were all assumed to be performed by the responsible party (or site owner) in conjunction with the vendor. None of these costs has been included in this economic analysis. Likewise, site characterization costs were not included in this cost analysis. Site characterization can add substantially to project costs. The following site characterization information should be available before designing and installing a NoVOCs™ treatment system: (1) site geology, (2) site hydrology, (3) geochemistry, and (4) contaminant distribution.

The focus instead was on technology-specific site preparation costs. Site preparation costs include the drilling and preparation of a single, 8-inch-diameter NoVOCs™ well and eight, 2-inch-diameter monitoring wells, well installation and construction oversight, utility connections, fence installation, and

TABLE 17

**COSTS ASSOCIATED WITH THE NoVOCs™ SYSTEM
NoVOCs™ SITE Demonstration
Site 9, NAS North Island, California**

Cost Categories	Costs in 1999 Dollars^a
1. Site Preparation ^b	\$57,000
2. Permitting and Regulatory Requirements ^b	\$15,000
3. Equipment ^b	\$95,000
4. Startup ^b	\$10,000
5. Labor ^c	\$42,000
6. Consumables and Supplies ^c	\$50,000
7. Utilities ^c	\$11,000
8. Effluent Treatment and Disposal ^c	\$8,000
9. Residual and Waste Shipping and Handling ^{c,d}	\$13,000 (\$3,000)
10. Analytical Services ^{c,e}	\$28,000 (\$21,000)
11. Maintenance and Modifications ^c	\$10,000
12. Demobilization ^b	\$14,000
Total One-time Costs	\$190,000
First Year Operation and Maintenance Costs	\$160,000
Subsequent Years' Annual Operation and Maintenance Costs	\$150,000
Total Costs of Project Lasting 1 Year^f	\$350,000
Total Costs of Project Lasting 3 Years^f	\$670,000
Total Costs of Project Lasting 5 Years^f	\$1,000,000
Total Costs of Project Lasting 10 Years^f	\$2,000,000

Notes:

- ^a Costs have been rounded to two significant digits
- ^b One-time cost
- ^c Annual variable operation and maintenance cost
- ^d The figure represents residual and waste shipping and handling costs for the first year of operation. Annual residual and waste shipping and handling costs for successive years are estimated to be \$3,000.
- ^e The figure represents analytical service costs for the first year of operation. Annual analytical service costs for successive years are estimated to be \$21,000.
- ^f Accounts for an estimated annual inflation rate of 4 percent

auxiliary support buildings. These are generally one-time charges and will vary, depending on site-specific conditions and project requirements.

Assuming an average cost of \$60 per feet, the drilling and installation costs for a NoVOCs™ well and eight monitoring wells is estimated to be \$33,600 (\$60/ft x 560 ft). Development of the wells is estimated to cost \$4,200, assuming 3 days for development, 8 hours per day at a rate of \$175 per hour. Well installation and construction oversight is estimated to cost \$9,000, assuming two field technicians are required to work 9 days (6 days for well drilling and installation and 3 days for well development), 10 hours per day at a rate of \$50 per hour. These cost included equipment mobilization to the site. Because installation was conducted by a local contractors, travel and per diem costs were not incurred.

According to Bechtel, costs associated with drilling, installation, and development of a single NoVOCs™ well installed at a depth of 80 feet bgs and 14 monitoring wells installed at depths ranging from 40 to 80 feet bgs during the SITE demonstration at NAS North Island were \$110,000. Because of difficult drilling conditions encountered at Site 9, such as flowing sands, this cost may not be representative of typical site preparation costs.

Based on SITE demonstration experience, it was estimated that utility connections would cost about \$6,000, assuming that an electrical connection is available within 200 feet of the system and no transformer is needed. A 6 by 8 by 8-foot support building to house miscellaneous equipment was estimated to cost \$2,000. A fence to enclose the NoVOCs™ wellhead, monitoring wells, control trailer, and offgas treatment system is estimated to cost \$2,000.

The total site preparation cost is estimated to be \$56,800.

4.2.2 Permitting and Regulatory Requirements Costs

This category includes costs associated with system health and safety monitoring and analytical protocol development as well as permitting costs. Permitting and regulatory costs are site- and waste-specific and can vary, depending on whether treatment occurs at a Superfund or a RCRA corrective action site, and on state and local requirements. Superfund sites require remedial actions to be consistent with applicable or relevant and appropriate requirements (ARAR), including federal, state, and local standards and criteria.

In general, ARARs must be determined on a site-specific basis. RCRA corrective action sites would require additional permitting, monitoring, and records. Permits that may need to be considered for this technology include drilling and air discharge permits.

Permitting and regulatory costs include preparation of required regulatory documents and are estimated to be about \$15,000. However, obtaining and complying with permits and any other regulatory standards could potentially be a very expensive and time consuming activity.

4.2.3 Equipment Costs

Equipment costs include the NoVOCs™ system and an offgas treatment system. Costs for equipment associated with monitoring wells are included in the installation costs presented in Section 4.2.1, Site Preparation Costs. Equipment for the NoVOCs™ system includes (1) hardware and materials, such as well screens and casing, well pack materials, and a wellhead seal; and (2) mechanical components, such as a control trailer, blower, gauges, control panels, meters, and pumps. Also included in the capital costs of the NoVOCs™ well are preliminary and final design of the well. Based on the SITE demonstration, hardware and material costs are estimated to be \$10,000, and the mechanical components are estimated to be \$50,000. Preliminary and final design will be conducted by a senior engineer and is estimated to require about 60 hours for preliminary design and 160 hours for final design. Assuming a labor rate of \$90 per hour for a senior engineer, total design costs for a NoVOCs™ well are about \$19,800. Total equipment cost for a NoVOCs™ system are estimated to be about \$79,800.

The offgas treatment system for this economic analysis is assumed to consist of two 1,800-pound vapor-phase activated carbon units, ancillary piping connecting the carbon units to the NoVOCs blower, and activated carbon. Monthly carbon adsorption unit rental costs are discussed in Section 4.3.6, Consumables and Supplies Costs. It is estimated that the cost for this equipment will be about \$15,000. The costs of disposing of or recharging the carbon are discussed in Section 4.2.8, Effluent Treatment and Disposal Costs.

Total equipment cost for the NoVOCs system and offgas treatment system is estimated to be \$94,800.

4.2.4 Startup Costs

Startup costs include operator training, system optimization, and system shakedown costs. This analysis assumes that one operator must be trained. Operator training costs are assumed to require about 40 hours of training or about \$2,000 assuming a labor rate of \$50 per hour. Optimization and shakedown activities include initial startup, trial runs, final equipment inspection, and associated labor for conducting these activities. Based on SITE demonstration experience, it is estimated that these activities will require one person, 24 hours a day for 7 days. Assuming an average labor rate of \$50 per hour, labor costs for system optimization and shakedown would be \$8,400 (168 hours x \$50 per hour).

Total startup costs are estimated to be about \$10,400.

4.2.5 Labor Costs

Hourly labor rates for operation include base salary, benefits, overhead, and general and administrative expenses. Labor rates do not include travel, per diem, or rental car because it is assumed that labor would be hired locally. This cost analysis assumes that labor costs will be limited to system inspection, monitoring, adjustments, sampling, and minor maintenance and repair of equipment. To complete these labor requirements, it is estimated that it two field technicians will be on site 1 day a week for 8 hours. Assuming a labor rate of \$50 per hour, weekly labor costs are estimated to be \$800 or \$41,600 annually.

4.2.6 Consumables and Supplies Costs

Consumables and supplies costs include renting activated carbon units to treat system offgas and acid and biocide solutions to control fouling of the NoVOCs™ well. Costs for personal protective equipment are included with the labor costs (see Section 4.2.5) presented above, and the costs for sampling equipment are assumed to be incurred during site characterization studies. The monthly rental cost for an activated carbon unit is estimated to be \$750 per unit. This analysis assumes that two activated carbon units will be used per year for a total annual cost of about \$18,000.

This cost estimate assumes that the system requires injection of about three, 55-gallon drums of HCl per month and three, 55-gallon drums of biocide per month. Given the costs of a 55-gallon drum of HCl of

\$400 and a 55-gallon drum of biocide of \$500, annual acid and biocide solution costs are estimated to be \$14,400 and \$18,000, respectively.

Total consumables and supplies costs are estimated to be \$50,400 annually.

4.2.7 Utilities Costs

The major utility demand for this project was electricity, primarily to run the blower and associated control systems. Assuming a blower with a 10 horsepower (HP) rating and electricity costs of \$0.09 per kilowatt-hour (kWh), the annual utility cost associated with the blower would be \$5,585 (10 HP x 0.7457 kW/HP x 22.8 hours per day x 365 days per year x \$0.09/kWh). This analysis assumes that the treatment system would operate 22.8 hours per day or 95 percent of the time. Assuming that other energy usage, such as lights and air conditioning, account for an equal amount, the total annual utility usage was estimated to be about \$11,200 annually.

Electrical costs can vary by as much as 50 percent, depending on geographical location and local utility rates. This analysis assumes that no alternative sources of electrical power, such as a diesel-powered generator, would be used as backup.

4.2.8 Effluent Treatment and Disposal Costs

Other than the offgas, no other effluent or wastes are generated by the operation of the NoVOCs™ system. This analysis assumes that the activated carbon units will be replaced every 3 months. The actual frequency of replacement will be primarily dependent on contaminant concentration and air flow rate. Based on vendor quotes, the costs for reactivating carbon is estimated to be about \$1,000 for each unit. This cost includes transportation, reactivation, and a change-out unit. Total annual replacement costs are therefore estimated to be \$8,000.

During the SITE demonstration at NAS North Island, Site 9, the NoVOCs™ system offgas was treated using the Thermatrix Flameless Oxidation System. The Thermatrix system was selected by the Navy because it can destroy organic compounds with a removal efficiency of 99.99 percent, and on-site treatment of contaminants is the treatment method preferred by the local community. Based on cost

information provided by SWDIV, the total cost of the Thermatrix system during the NoVOCs™ demonstration was about \$989,000. This cost includes system acquisition, installation, operation, maintenance, monitoring, and source testing. A detailed breakdown of these costs is provided in Table 18. The Thermatrix system costs are provided for information purposes only. The cost analysis assumes that a more common offgas treatment method, activated carbon, is used to treat the NoVOCs™ offgas.

4.2.9 Residuals and Waste Shipping and Handling Costs

No residuals or wastes are generated from the operation of the NoVOCs™ system. Drill cuttings, however, would be generated during installation and removal of the system well, and purge water would be generated from periodic sampling activities. Disposal of wastes generated during removal of the system well are addressed in Section 4.2.12, Demobilization Costs. Disposal of drilling wastes (cuttings) from installation activities are assumed to occur in the first year after installation. This cost estimate assumes that the cuttings are not characteristically hazardous but that the cuttings are disposed of at a licensed hazardous waste disposal facility. The cost for disposal of the cuttings is estimated to be \$10,000 and includes transportation, treatment, and disposal as a bulk solid in a landfill.

For the purge water, this analysis assumes that the contaminant concentration would be below RCRA regulatory levels that require storage and treatment as a hazardous waste. Purge water would be collected in 55-gallon carbon-steel drums and disposed of at an off-site industrial wastewater treatment and disposal facility. This analysis assumes that about 150 gallons of purge water would be generated during each quarterly sampling event. This analysis further assumes that a licensed waste hauler would transfer the wastes from the drums into a tanker truck and that the purge water would be transported about 100 miles to the nearest industrial wastewater treatment facility. Transportation costs (including pumping and labor costs) are estimated to be \$700 per trip, and disposal costs are estimated to be \$0.25 per gallon. Purge water disposal costs are therefore estimated at about \$3,000.

Total annual residuals and waste shipping costs in the first year of operation are estimated to be \$13,000. Total annual costs for the subsequent years are estimated to be \$3,000. The high residuals and waste shipping costs during the first year are associated the disposal of soil cutting.

TABLE 18

**COSTS ASSOCIATED WITH THE THERMATRIX SYSTEM
NoVOCs™ SITE Demonstration
Site 9, NAS North Island, California**

Cost Categories	Costs in 1999 Dollars
Project Management	\$106,000
Engineering	\$87,000
Plan Preparation	\$33,000
System Manufacturing	\$300,000
Site Installation	\$97,000
Sampling and Analysis	\$98,000
Operation	\$113,000
Travel	\$14,000
Source Testing	\$141,000
Total	\$989,000

4.2.10 Analytical Services Costs

Analytical costs include laboratory analyses, data reduction and tabulation, QA/QC, and reporting. This analysis assumes that the following samples would be collected and analyzed for VOCs using EPA-approved methods: a total of 50 groundwater and air samples collected during system startup and shakedown, untreated and treated groundwater and air samples collected from the NoVOCs™ well once per month, and groundwater samples collected from each of the eight surrounding monitoring wells quarterly. In addition, QA/QC samples consisting of a trip blank, a field and equipment blank, a field duplicate, and MS/MSD samples will be collected during each quarterly sampling event. Assuming an analytical cost of \$150 per sample, startup and shakedown analytical costs would be \$7,500 (50 samples x \$150 per sample). Monthly analytical costs would be \$600 (2 groundwater and 2 air samples x \$150 per sample) or about \$7,200 annually. Quarterly laboratory analytical costs would be \$2,400 ([8 groundwater and 2 air samples + 6 QA/QC samples] x \$150 per sample) or about \$9,600 annually. Data reduction, tabulation, data validation, and reporting is estimated to cost about \$1,000 per quarter or

\$4,000 per year. Total annual analytical services costs are therefore estimated to be about \$28,300 in the first year and \$20,800 per year thereafter.

4.2.11 Maintenance and Modification Costs

This cost analysis does not include labor, materials, and equipment costs associated with major maintenance requirements or modifications to the system. Annual maintenance requirements are assumed to consist of the removal of the internal well components for cleaning, inspection, and replacement, if necessary. Annual maintenance costs are estimated to be \$10,000. Costs for routine maintenance and repairs are included in the labor costs presented in Section 4.2.5, Labor Costs.

4.2.12 Demobilization Costs

Site demobilization includes shutdown, disassembly, well plugging and abandonment, and transportation and disposal of equipment to a licensed hazardous waste disposal facility. Well plugging and abandonment procedures consist of overdrilling the well and pressure grouting the boring to the ground surface. Demobilization would occur at the end of the groundwater remediation project and is estimated to take about 5 days to complete. This analysis assumes that the NoVOCs™ technology would have no salvage value at the end of the project. The majority of the demobilization costs apply to waste disposal, which is estimated to be about \$10,000. This estimate assumes that the waste is not characterized as hazardous. The wastes requiring disposal include the casing and filter pack from overdrilling, the NoVOCs™ system itself, and ancillary piping and equipment associated with the carbon adsorption units. The total volume of waste is assumed to be 30 cubic yards. The cost for waste disposal includes transportation and labor. Labor costs associated with all activities other than well plugging and abandonment during demobilization would include two technicians working 5 8-hour days and are estimated to be about \$4,000 (80 hours x \$50 per hour); labor costs associated well plugging and abandonment are accounted for in the waste disposal cost. Total demobilization costs are therefore estimated to be about \$14,000.

4.3 COST SUMMARY

This section summarizes the estimated costs in 1999 dollars for using the NoVOCs™ system under the conditions described in the previous sections. Table 17 presents a breakdown of costs for the 12 categories previously identified. The table presents fixed costs and annual variable costs and compares the costs for groundwater treatment projects with durations of 1, 3, 5, and 10 years. The cost of treatment per unit volume of water was not calculated because of the number of assumptions required to make such a calculation, including shape and size of the NoVOCs™ circulation cell, amount of water recirculated by the system, contaminant type and concentration, type of offgas treatment system used, and treatment goals. These factors are site-specific. Therefore, treatment costs per unit volume of water will vary greatly from project to project. The cost estimate for each category and total costs were rounded to two significant numbers. One-time capital costs for a single treatment unit were estimated to be \$190,000; annual operation and maintenance costs were estimated to be \$160,000 for the first year and \$150,000 per year thereafter. Based on these estimates, the total cost for operating a single NoVOCs™ system was calculated to be \$350,000 for 1 year, \$670,000 for 3 years, \$1,000,000 for 5 years, and \$2,000,000 for 10 years. These costs include a 4 percent annual inflation rate. Costs for implementing a NoVOCs™ system at another site may vary substantially from this estimate for the SITE demonstration.

5.0 CONCLUSIONS

This section presents the conclusions of the SITE evaluation of the NoVOCs™ technology at NAS North Island, Site 9. The NoVOCs™ system did not function without operational difficulties in the highly saline aquifer containing groundwater with TDS ranging from 18,000 to 41,000 mg/L, which represents an extreme geochemical environment. Conclusions are presented for operation and maintenance of the NoVOCs™ system and for each demonstration objective.

Operation and Maintenance. Operation and maintenance of the NoVOCs™ system was conducted primarily by Bechtel with assistance from MACTEC. The NoVOCs™ system was designed to operate continuously, 24 hours a day, 7 days a week. However, during the demonstration, the system experienced significant operational difficulties and was limited to four main operating periods: System Startup and Shakedown (February 26 through March 26, 1998), Early System Operation (April 20 through June 19, 1998), Reconfiguration Operation (September 24 through October 30, 1998), and Final Configuration Operation (December 4, 1998 through January 4, 1999).

Beginning in early May 1998, the NoVOCs™ system began experiencing operating problems associated with high water levels in the NoVOCs™ well and lower-than-designed pumping rates. Initially, it was thought that the flow sensor was not accurately measuring the pumping rate. However, as system operation progressed, the continued low pumping rate and increased frequency of the high water level in the NoVOCs™ well suggested that a more significant problem was occurring. By June 1998, the pumping rate had been reduced from the design rate of 25 gpm to about 5 gpm. Based on discussions between the Navy and the technology vendor, the system was shut down on June 19, 1998, to evaluate the cause of the poor performance. Suspected causes for the poor performance included (1) biofouling or scaling of the screen intervals and formation near the NoVOCs™ well, (2) possible differences in hydraulic characteristic between the upper and lower portions of the aquifer, and (3) design problems with the NoVOCs™ well, in particular, the length of the recharge screen.

To evaluate the recharge capacity of the NoVOCs™ system and provide information on the hydraulic characteristics of the aquifer in the vicinity of the NoVOCs™ system, a down-well video tape survey and a series of aquifer hydraulic tests were conducted. Based on the aquifer testing, it was concluded that the NoVOCs™ well should be able to sustain the design pumping rate of 25 gpm. However, during the

video tape survey, fouling of the NoVOCs™ well screens by iron precipitation and microbiological growth was observed, which appeared to have impaired the performance of the NoVOCs™ system by obstructing the well screen and filter pack. Attempts to control fouling by addition of a commercial surfactant product and a commercial biocide were unsuccessful, and the failure to control the fouling eventually caused the termination of the demonstration in January 1999.

Based on the results of the SITE demonstration at NAS North Island and other recirculating well evaluations, well fouling is a recognized problem that requires an appropriate design as well as operation and maintenance activities for successful management. In-well stripping systems and recirculating wells, such as the NoVOCs™ system, are subject to fouling from a variety of common causes. The three most common causes of fouling are (1) accumulation of silt in the well structure, (2) biofouling by colonizing microorganisms, and (3) formation of chemical precipitates and insoluble mineral species. These issues can sometimes be controlled through appropriate design and construction of filter pack and well screens, groundwater pH control to manage formation of chemical precipitates and insoluble mineral species, and injection of a suitable biocide to prevent biofouling. However, any design that does not provide geochemical controls based on site-specific hydrogeologic and geochemical conditions is likely to experience significant operation and maintenance problems due to fouling.

Demonstration Objectives. The conclusions relative to each primary and secondary evaluation objective are summarized below:

Primary Objectives:

P1 Evaluate the removal efficiency of the NoVOCs™ well system for VOCs in groundwater.

Comparison of VOC results for groundwater samples taken adjacent to the influent and effluent of the NoVOCs™ system indicated that 1,1-DCE, cis-1,2-DCE, and TCE concentrations were reduced by greater than 98, 95, and 93 percent, respectively, in all the events, except the first sampling event, which was conducted during system shakedown activities. Excluding the first sampling event, the mean concentrations of 1,1-DCE, cis-1,2-DCE, and TCE in the water discharged from the NoVOCs™ system were about 27, 1,400, and 32 micrograms per liter (Fg/L), respectively. The 95 percent upper confidence limits of the means for 1,1-DCE, cis-1,2-DCE, and TCE in the treated groundwater were calculated to be

about 37, 1,760, and 46 Fg/L, respectively. The maximum contaminant levels (MCL) for these compounds in groundwater are 6 Fg/L for 1,1-DCE, 6 Fg/L for cis-1,2-DCE, and 5 Fg/L for TCE. MACTEC claims that the NoVOCs™ system can reduce effluent VOC concentrations to below MCLs if the contaminant source has been removed. Since dense nonaqueous-phase liquids may be present in the aquifer at the site and may act as a continuing source of groundwater contamination, MACTEC did not make any claims for reduction of VOC concentrations in groundwater at Site 9.

P2 Determine the radial extent of the NoVOCs™ treatment cell.

Because of the sporadic operation of the NoVOCs™ system, a direct evaluation of the radial extent of the NoVOCs™ treatment cell was not conducted. In lieu of direct evaluation method, aquifer hydraulic tests conducted to assess the hydrogeologic characteristics of the site were used to indirectly evaluate the potential radial extent of the NoVOCs™ treatment cell. Although the aquifer pump tests cannot be directly applied to evaluate the radial extent of the NoVOCs™ treatment cell or even that groundwater recirculation was established, the test data does provide information on the radius of influence of the well under pumping (2-dimensional) and dipole (3-dimensional) flow conditions. The resulting changes in pressure head provide an indication of the potential for flow in the surrounding aquifer and are used to provide an estimate of the radial extent of influence created by the NoVOCs™ well. However, the pressure head changes do not accurately represent flow patterns or contaminant transport. Consequently no firm conclusions can be drawn about the radial extent of the NoVOCs™ treatment cell.

During the constant discharge rate (discharge = 20 gpm) pumping test, measurable drawdowns were observed at about 100 feet from the NoVOCs™ well in all directions and different depths. This information indicates that the radius of influence by extraction, specifically at 20 gpm, could be as large as 100 feet. The dipole flow test data shows that measurable pressure responses occur at crossgradient locations 30 feet from the NoVOCs™ well and may be observed at farther distances. However, no drawdowns or water level rises could be positively measured in monitoring wells beyond the 30-foot distance.

P3 Quantify the average monthly total VOC mass removed from groundwater treated by the system for 6 months.

Because of operational problems with the NoVOCs™ system, the mass of VOCs removed by the NoVOCs™ system was evaluated during a limited period of operation from April 28 to June 8, 1998. During this period, the average total VOC mass removed by the NoVOCs™ system ranged from 0.01 to 0.14 pounds per hour (lb/hr) and averaged 0.10 lb/hr during the five sampling events. Accounting for the sporadic operation of the NoVOCs™ system, the mass of total VOCs removed during the entire operation period from April 20 through June 19, 1998, was estimated to be about 90 pounds.

Secondary Objectives:

S1 Quantify the changes in VOC concentrations in the groundwater within the NoVOCs™ treatment cell.

VOC concentrations appear to be stratified in the aquifer. In general, the highest concentrations of the three primary VOCs, 1,1-DCE, cis-1,2-DCE, and TCE, were detected in the deep monitoring wells. This trend was especially pronounced for cis-1,2-DCE, which was detected at concentrations between 440 and 96,000 Fg/L in the deep wells, but only between 120 and 1,200 Fg/L in the shallow wells. The intermediate wells generally had the lowest concentration of all three primary VOCs. Because of the limited amount of data collected and operational problems with the NoVOCs™ system throughout the demonstration, trends in the VOC concentration data associated with operation of the NoVOCs™ system were not apparent.

S2 Document changes in selected geochemical parameters that may be affected by the NoVOCs™ system.

Groundwater samples were collected and analyzed for dissolved metals, alkalinity, total organic carbon, and dissolved organic carbon to evaluate changes in the selected geochemical parameters caused by the NoVOCs™ system. Despite the possible iron fouling problems experienced in the NoVOCs™ well, the groundwater analytical results for dissolved metals exhibited no clear trends in the data that would suggest that precipitation of dissolved metals was occurring in the aquifer. Based on a review of the data, alkalinity, total organic carbon, and dissolved organic carbon results remained relatively unchanged during the demonstration. Total dissolved solid concentrations showed an increasing trend with depth;

however, concentrations did not appear to be affected by operation of the NoVOCs™ system. Conductivity and salinity values measured in the field also increased with depth and appeared to correlate with the analytical results for total dissolved solids. No clear trends were apparent from the field measurements of temperature, pH, and dissolved oxygen, and insufficient data were collected to adequately evaluate trends associated with oxidation/reduction potential.

S3 Document NoVOCs™ system operating parameters.

During the four operational periods, Bechtel measured the NoVOCs™ system operating parameters, including air temperature, pressure, flow rate, water pumping rate, and pH in the groundwater effluent. The average air temperature at the well intake during the four operational periods ranged from 132 to 152 °F; the pressure ranged from 2.2 to 3.3 pounds per square inch; and air flow ranged from 52.4 to 69.0 standard cubic feet per minute. The water pumping rate within the NoVOCs™ well varied throughout the demonstration; however, based on data provided by SWDIV, the pumping rate ranged from 8 to 34 gpm. Additionally, the average pH in the groundwater effluent during the four operational periods ranged from 3.60 to 7.28.

S4 Document pre- and post-treatment VOC concentrations and system operating parameters in the Thermatrix flameless oxidation offgas treatment system.

Based on a comparison of influent and effluent air samples collected from the Thermatrix system, total VOC concentrations in the 1-hour composite samples collected from the influent ranged from 22,120 to 59,200 parts per billion (ppb) on a volume per volume (v/v) basis and averaged 45,200 ppb v/v during the five sampling events. Total VOC concentrations in the 1-hour composite samples collected from the effluent air sample port ranged from 2.8 to 7.2 ppb v/v and averaged 4.8 ppb v/v during the five sampling events. Total VOC concentrations measured in the Thermatrix influent air sample port were reduced by greater than 99.9 percent in all five sampling events.

S5 Document the hydrogeologic characteristics at the treatment site.

Based on the results of the hydrogeologic investigation conducted at the treatment site, the following hydrogeologic characteristics were determined:

- C Groundwater generally flows to the west or northwest in both of the upper and lower aquifer zones. The horizontal hydraulic gradient in both aquifer zones is relatively flat, ranging from 0.005 to 0.01. Groundwater direction and velocity measurements collected from monitoring well near the shoreline of the San Diego Bay using the Colloidal Borescope indicate that groundwater flows in a west-southwest direction at an average of velocity of 5 ft/day.
- C The average hydraulic conductivity was estimated as 29 ft/day or 0.01 cm/sec. The average aquifer storativity and specific yield are 0.004 and 0.07, respectively. The average ratio of horizontal to vertical hydraulic conductivity is estimated at 5.7.
- C The calculated average specific capacities are 1.48 gpm/ft for the upper screened interval during pumping, 1.50 gpm/ft for the upper screened interval during injection, and 3.22 gpm/ft for the lower screened interval during pumping. The calculated average well efficiencies are 82 percent for the upper screened interval during pumping, 97 percent for the upper screened interval during injection, and 91 percent for the lower screened interval during pumping.
- C The radius of influence during the constant discharge pumping test (20 gpm) was at least 100 feet based on drawdown measured at the observation wells.
- C The maximum flow of clean tap water that can be injected through the upper screen of the NoVOCs™ well is 25 gpm.
- C The aquifer hydraulic conditions are suitable for application of the NoVOCs™ technology. The NoVOCs™ well as designed should be able to extract and inject a flow rate of 20 gpm based on the aquifer hydraulic characteristics.

S6 Document the changes in pressure head in the aquifer caused by the NoVOCs™ system.

Pressure head changes in the aquifer caused by the NoVOCs™ system were measured in the groundwater monitoring wells in the vicinity of the NoVOCs™ system during a tidal study conducted at the treatment site before and during operation of the NoVOCs™ system. Groundwater level changes caused by startup and shutdown of the NoVOCs™ system were evident in the water level data for well cluster MW-45, MW-46, and MW-47, located about 30 feet from the NoVOCs™ well. The water level data for observation wells MW-45 (the upper screened well in this cluster) and MW-46 (intermediate screened well) showed water level increases after system startup. The groundwater elevation increase in well MW-45 was approximately 0.15 feet. Observation well MW-46, the intermediate depth well, showed a water level increase of approximately 0.05 feet. Observation well MW-47, the deep screened well, showed a water level decrease of approximately 0.025 feet. This pattern of water level increases and decreases associated with the operation of the NoVOCs™ system was expected based on the monitoring

well screen locations relative to the NoVOCs™ well screen locations. The deep screened well experienced a drop in water level as water was drawn toward the NoVOCs™ well intake, and the upper screened wells experienced increases in water level as water was lifted inside of the NoVOCs™ well and discharged into the upper aquifer zone. In well pair MW-48 and MW-49 (located about 62 feet from the NoVOCs™ well) and in wells MW-50 and MW-51 (located about 91 and 105 feet, respectively, from the NoVOCs™ well), water level changes associated with NoVOCs™ system operation were not apparent.

S7 Estimate the capital and operating costs of constructing the NoVOCs™ system and Thermatrix flameless oxidation process and maintaining them for 6 months.

An economic analysis of using the NoVOCs™ and Thermatrix technologies to treat VOC-contaminated groundwater and offgas was conducted. Based on the SITE evaluation and cost information provided by the Navy and MACTEC, one-time capital costs for a NoVOCs™ system were estimated to be \$190,000; annual operation and maintenance costs were estimated to be \$160,000 per year for the first year and \$150,000 per year thereafter. Because of the time required to remediate an aquifer is site-specific, costs have been estimated for operation of a NoVOCs™ system over a range of time for comparison purposes. Based on these estimates, the total cost for operating a single NoVOCs™ system was calculated to be \$350,000 for 1 year; \$670,000 for 3 years; \$1,000,000 for 5 years; and \$2,000,000 for 10 years. These estimates include an annual inflation rate of 4 percent.

Costs for implementing a NoVOCs™ system at another site may vary substantially from this estimate for the SITE evaluation. A number of factors affect the cost of treatment using the NoVOCs™ system, including soil type, contaminant type and concentration, depth to groundwater, site geology and hydrogeology, groundwater geochemistry, site size and accessibility, required support facilities and available utilities, type of offgas treatment unit used, and treatment goals. It is important to (1) characterize the site thoroughly before implementing this technology to ensure that treatment is focused on contaminated areas and (2) determine the circulation cell radius for the well and the resulting number of wells needed to remediate a particular site.

The cost of treatment per unit volume of water was not calculated because of the number of assumptions required to make such a calculation and the limited duration of system operation. Because of the site-specific nature of treatment costs, costs per unit volume of water will vary greatly from project to project.

Based on cost information provided by SWDIV, the total cost of the Thermatrix system during the NoVOCs™ demonstration was about \$989,000. This cost includes system acquisition, installation, operation, maintenance, monitoring, and source testing.

6.0 TECHNOLOGY STATUS

This section presents the NoVOCs™ technology status and was written solely by MACTEC. The statements presented in this section represent the vendor's point of view and summarize the claims made by the vendor regarding the NoVOCs™ system. Publication of this material does not represent the EPA's approval or endorsement of the statements made in this section; results of the performance evaluation of the NoVOCs™ at NAS North Island are discussed in the previous sections of this report. In addition, case studies provided by the vendor that document the performance of the NoVOCs™ technology at other sites is presented in Volume I, Appendix B.

MACTEC Environmental Technologies Company (MACTEC) acquired an exclusive license to the NoVOCs in-well volatile organic compound (VOC) stripping system from EG&G Environmental during December of 1997. Along with the license, MACTEC also continued on-going support of the NoVOCs demonstration at Installation Restoration Site No. 9 at the Naval Air Station (NAS) North Island in San Diego, California. To complete the demonstration project and maintain continuity of the project team working on the project, MACTEC subcontracted much of the design and implementation to a number of individuals recommended by the Navy who were working on the project prior to MACTEC's involvement.

In June of 1999, MACTEC acquired 26 patents covering the equipment, use, and application of groundwater recirculating well technology (RWT). These patents were purchased from the inventors of the technology, IEGmbH (IEG) and included the well known UVB process as well as other RWT arrangements. MACTEC acquired the NoVOCs and IEG technologies for several fundamental reasons:

- C Proven Success in Field Applications. These technologies have been applied at a variety of test sites as well as on site remediation projects since early 1990s. At the time of MACTEC'S acquisition there were over 30 successful applications of the NoVOCs type systems and well over 300 IEG type RWT wells worldwide. In fact there are documented site closures for a number of these wells. The technologies have been installed in various geological formations (including fractured bedrock), been applied to VOCs as well as non-volatile compounds, and have been used for enhanced free product recovery, enhanced mass removal from soil and groundwater, bioremediation, treatment of VOCs, and other applications. (A partial listing of NoVOCs and IEG type systems is provided in Section 6.2).

- C Superior Field Performance. MACTEC's research prior to acquisition of the technologies indicated that many RWT systems were selected at sites where pump and treat type systems had or would fail to remove significant contaminant mass. The NoVOCs's and IEG type RWT systems are proven to remove mass at higher rates than pump and treat systems mainly due to the dynamics of the groundwater recirculation zone. At one recent application, the mass of VOCs removed was nearly an order of magnitude larger than what was anticipated based on nearby pump and treat type systems. Field experience has also shown that the stripping efficiency of the NoVOCs and IEG type RWT systems can be tailored to the site needs and can be designed to be competitive with any system on the market.

- C Increasing Acceptance as a Viable Alternative. MACTEC's research indicated a preference among many owners of sites requiring remediation and state regulators toward the RWT approach due to its targeted mass removal. The combination of RWT, for source removal, with intrinsic remediation is also becoming widely considered as a preferred approach.

- C Life Cycle Remedial Cost. From the limited data available on completed life cycles for RWT, pump and treat, and other remedial solutions, RWT scores very well, coming in at one-half to one-fifth the overall cost. (e.g., Quinton, G.E., et. Al., 1997, "A Method to Compare Groundwater Cleanup Technologies". Remediation (Autumn) 7 - 16).

The above information is not provided to suggest that the NoVOCs systems and RWT systems can be applied without proper geologic and design considerations. Like other technologies, NoVOCs and RWT systems have limitations to their application and are not applicable to all types of contaminants in all geologies. In fact, the results of the NAS North Island demonstration emphasize this fact since the geology and groundwater conditions resulted in fouling of the well and certainly would have also led to the fouling of a pump and treat system had it been applied in the same conditions.

The technologies do have broad use in the remediation market place and design considerations can be put in place to overcome field constraints. For example, where iron fouling of RWT is likely, closed loop systems have proven to minimize fouling. A closed loop NoVOCs system operating at a landfill in Washington State has had minimal problems operating in a high iron environment since there is very little oxygen in the gas being circulated in the closed loop system. Likewise, several IEG type RWT systems operating in the closed loop mode have confirmed that removing the oxygen from the system minimizes the fouling potential.

MACTEC's key components for a good design of a NoVOCs or RWT system are as follows:

- C Understanding of the hydrogeology. For RWT systems this is typically collected in a dual screen pump test that yields a vertical hydraulic conductivity. This pump test data can be used in MACTEC's models to predict the zone of influence and performance of the RWT system.
- C Understanding the geochemistry. Typically collected with groundwater analytical data, the interaction of an process with the groundwater and soil environment needs to be assessed to select pre- or post-treatments that will avoid fouling and to design a system that will function properly.
- C Understanding the contaminant distribution. Targeted use of the RWT systems can be achieved through proper site investigation.
- C Flexibility in technology selection. MACTEC provides a suite of technologies from very simple air lift systems to highly engineered RWT systems. Selecting the correct components to match the site conditions is critical to success.
- C Understanding of the remedial decision making process. There are points in site remediation projects where goals can change based on changed conditions. Flexibility in understanding this aspect of remedial projects can lead to cost-effective decisions.
- C Employing the proper project team. MACTEC has found that, whether considering the managers, designers, or field implementation team, the quality of people involved with the project can make or break a RWT system.

Further information on case histories of NoVOCs and IEG type RWT projects, economic analysis of RWT systems compared to other technologies, and the suite of technologies that can be applied to recirculation well remedial systems are available from, and are being expanded on by MACTEC. If you have questions or comments contact Joe Aiken at MACTEC, Inc., 1819 Denver West Drive, Suite 400, Golden, Colorado 80401, (303) 273-5082.

7.0 REFERENCES

- Bechtel National, Inc. (Bechtel). 1996. Final Technical Memorandum, Additional Site Characterization for NoVOCs™ Technology Demonstration at Site 9, Naval Air Station (NAS) North Island, San Diego, California. CTO-0084/0065. March.
- Bechtel. 1997a. Final Technical Memorandum, S9-CPT-05 Site Characterization for NoVOCs™ Technology at Site 9, NAS North Island, San Diego, California. CTO-0084/0160. June.
- Bechtel. 1997b. Draft Addendum to Action Memorandum/Remedial Action Plan for Removal Action at Installation Restoration Site 9, Naval Air Station North Island, Coronado, California. CTO-084/0159. June.
- Bechtel. 1998. Final Boring Logs, Cone Penetrometer Test Data, and Geologic Cross-Section of Site 9. Naval Air Station North Island.
- Clean Sites, Inc. 1998. Revised Work Plan Draft NoVOCs™ Pilot Test, Naval Air Station - North Island. March
- EG&G Environmental (EG&GE). 1996. Final Work Plan for NoVOCs™ Pilot Test at NAS North Island. June.
- EG&GE. 1997. Well Design for NAS North Island. August 13.
- Evans, G. 1990. Estimating Innovative Treatment Technology Costs for the SITE Program. Journal of Air and Waste Management Association. Vol. 40, No. 7. July.
- Freeze, R.A., and J.A. Cherry. 1979. Groundwater. Prentice-Hall, Inc. Englewood Cliffs, NJ.
- Hackett G., and J.H. Lehr. 1985. Iron Bacteria Occurrence, Problems and Control Methods in Water Wells. September 30.
- Jacob, C.E. 1950. Flow of Ground Water. Engineering Hydraulics. Edited by H. Rouse. John Wiley and Sons, Inc., New York. Pages 321-386.
- Jacobs Engineering Group, Inc. (Jacobs). 1994. Technical Memorandum, Site 9 - Chemical Waste Disposal Area, NAS North Island, Volume I, Revision 0. April 6.

- Jacobs. 1995a. Draft Remedial Investigation/Resource Conservation and Recovery Act Facility Investigation Report, Site 9 - Chemical Waste Disposal Area, NAS North Island, Volume I, Revision 0. October.
- Jacobs. 1995b. Naval Air Station North Island, San Diego, California, Remedial Investigation, RCRA Facility Investigation Report, Site 9, Chemical Waste Disposal Area. October.
- Kennedy. 1975. Geology of the San Diego Metropolitan Area, California. California Division of Mines and Geology. Bulletin 200.
- SPAWAR Systems Center (SPAWAR). 1998. Draft Report of Findings: Offshore Sampling of Porewater VOC Levels and Groundwater VOC Fluxes to San Diego Bay at Site 9, Naval Air Station North Island. SPAWAR Systems Center, San Diego, California.
- Tetra Tech EM Inc. (Tetra Tech). 1998. Technology Evaluation Plan/Quality Assurance Project Plan for the MACTEC Environmental NoVOCs™ Technology Evaluation at the Naval Air Station North Island, California. May.
- Tetra Tech. 2000. Hydrogeologic Investigation of the Aquifer Treated by the NoVOCs™ System, Naval Air Station North Island, San Diego, California. June.

NoVOCs™ Technology Evaluation Report

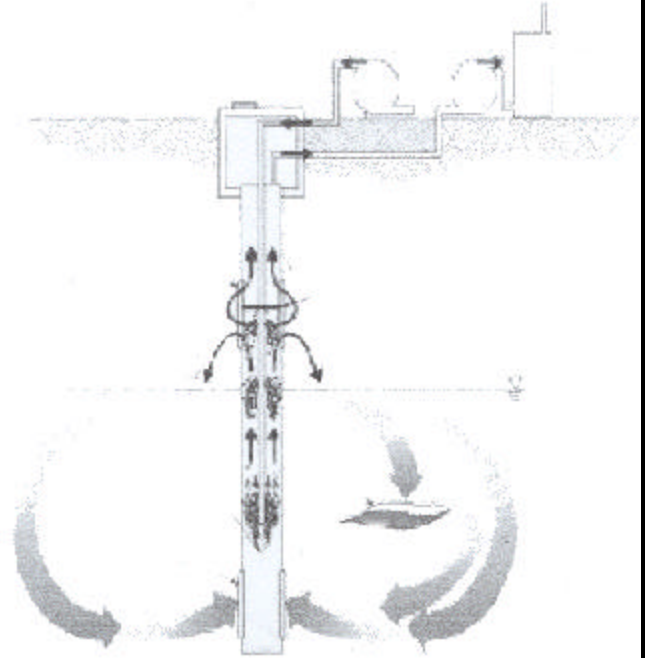

Appendix A Auxillary Tables and Graphs

Tables

Operation Summary

A1 Daily Operation Summary

A2 Operation and Maintenance
Summary

Field Parameter Summary

A3 Conductivity

A4 Dissolved Oxygen

A5 pH

A6 Reduction/Oxidation Potential

A7 Salinity

A8 Temperature

Geochemical Summary

A9 Alkalinity

A10 Total Dissolved Solids

A11 Total Organic Carbon and
Dissolved Organic Carbon

Semivolatile Organic Compound Summary

A12 1,2-Dichlorobenzene

Metals Summary

A13 Aluminum

A14 Antimony



NoVOCs™ Technology Evaluation Report

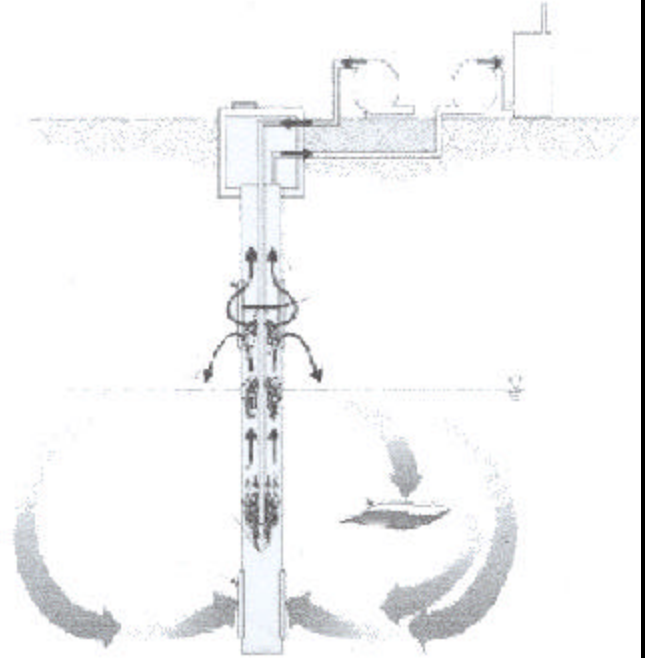

Appendix A Auxillary Tables and Graphs (Continued)

A15 Arsenic
A16 Beryllium
A17 Barium
A18 Cadmium
A19 Calcium
A20 Chromium
A21 Cobalt
A22 Copper
A23 Iron
A24 Lead
A25 Magnesium
A26 Manganese
A27 Mercury
A28 Nickel
A29 Potassium
A30 Selenium
A31 Silver
A32 Sodium
A33 Thallium
A34 Vanadium
A35 Zinc
A36 Groundwater VOC Results



TABLE A1

**DAILY OPERATION SUMMARY
NoVOCS™ SITE Demonstration
Site 9, NAS North Island, California**

Operation Period								
Startup/Shakedown		Early System Operation						
Date	Hours	Date	Hours	Date	Hour	Date	Hour	
2/26/98	5.5	4/20/98	9	5/8/98	7	6/4/98	24	
3/5/98	7.5	4/21/98	22	5/9/98	10.5	6/5/98	24	
3/6/98	1	4/22/98	22.5	5/11/98	12	6/6/98	24	
3/9/98	5	4/23/98	24	5/12/98	12	6/7/98	24	
3/13/98	9	4/24/98	24	5/13/98	12	6/8/98	24	
3/14/98	23	4/25/98	24	5/16/98	7	6/9/98	24	
3/15/98	24	4/26/98	24	5/17/98	24	6/10/98	18	
3/16/98	17	4/27/98	24	5/18/98	24	6/11/98	8	
3/17/98	24	4/28/98	24	5/19/98	24	6/12/98	24	
3/18/98	23	4/29/98	24	5/20/98	24	6/13/98	24	
3/19/98	24	4/30/98	24	5/21/98	24	6/14/98	24	
3/20/98	8	5/1/98	24	5/22/98	24	6/15/98	24	
3/21/98	24	5/2/98	24	5/23/98	23	6/16/98	24	
3/22/98	24	5/3/98	24	5/24/98	24	6/17/98	24	
3/23/98	24	5/4/98	8	5/25/98	24	6/18/98	24	
3/24/98	24	5/5/98	24	5/26/98	10	6/19/98	20	
3/25/98	24	5/6/98	24	6/1/98	7	-	-	
3/26/98	15	5/7/98	24	6/3/98	10	-	-	
Total	306	Total						1,056

Note:

Dates in bold indicate a weekly or monthly sampling event was conducted.

TABLE A1 (Continued)

**DAILY OPERATION SUMMARY
NoVOCS™ SITE Demonstration
Site 9, NAS North Island, California**

Operation Period							
Reconfiguration Operation				Final Operation			
Date	Hours	Date	Hours	Date	Hour	Date	Hour
9/24/98	24	10/17/98	7	12/4/98	7	12/22/98	24
9/25/98	24	10/19/98	11	12/5/98	18	12/23/98	24
9/26/98	12	10/20/98	13	12/6/98	24	12/24/98	21
9/29/98	1.5	10/21/98	24	12/7/98	11	12/25/98	24
9/30/98	14.5	10/22/98	24	12/8/98	0	12/26/98	22
10/1/98	21.5	10/23/98	24	12/9/98	5	12/27/98	24
10/2/98	22	10/24/98	24	12/10/98	21	12/28/98	23
10/6/98	12	10/25/98	24	12/11/98	24	12/29/98	16
10/7/98	12	10/26/98	22	12/12/98	24	12/30/98	8
10/8/98	12	10/27/98	11	12/13/98	24	12/31/98	22
10/09/98	24	10/28/98	8	12/14/98	24	1/1/99	24
10/10/98	24	10/29/98	9	12/15/98	24	1/2/99	24
10/11/98	10	-	-	12/16/98	24	1/3/99	19
10/12/98	12	-	-	12/17/98	24	1/4/99	10
10/13/98	24	-	-	12/18/98	24	-	-
10/14/98	12	-	-	12/19/98	24	-	-
10/15/98	5	-	-	12/20/98	24	-	-
10/16/98	15	-	-	12/21/98	24	-	-
Total			506.5	Total			635

TABLE A2

**OPERATION AND MAINTENANCE SUMMARY
NOVOCs™ SITE Demonstration
Site 9, NAS North Island, California**

DATE	DESCRIPTION
02/26/98 through 03/09/98	Startup of the NoVOCs™ system was initiated on February 26, 1998. The NoVOCs™ system underwent startup and shakedown activities through March 9, 1998.
03/13/98 through 03/25/98	The NoVOCs™ system operated continuously with only minor shutdowns for system checks and balances.
03/26/98	The NoVOCs™ system was shut down at 1500 because of lack of pH control.
04/20/98	The NoVOCs™ system was restarted; the pH meter was connected to the remote control panel.
05/04/98 through 05/13/98	The NoVOCs™ system operated continuously with periodic system shutdowns because of high water levels in the well.
05/14/98 through 05/15/98	The NoVOCs™ system was shut down to conduct system maintenance. The well components were removed from the well, and the upper and lower screens were redeveloped. Iron hydroxide precipitation was observed on the well screens and internal well components.
05/16/98	The NoVOCs™ system was restarted.
05/26/98	The NoVOCs™ system was shut down at 1030 because of failure of the pH pre-amplifier.
06/01/98	The pH pre-amplifier was repaired and the NoVOCs™ system was restarted; however, the NoVOCs™ system was later shut down because of low pH readings measured in the well.
06/03/98	The NoVOCs™ system was restarted at 1330 using reduced acid injection settings. The pH was initially around 7.0 and had stabilized at 7.5 at the end of the day. Water flow readings measured using a Magnehelic needle gauge at the wellhead indicated that water flow within the wells was about 1 to 3 gpm.
06/10/98	The NoVOCs™ system was shut down briefly to increase the depth of the air diffuser from 9.5 to 10.5 feet below the water table and to slightly increase the acid injection rate at the well. The NoVOCs™ system was shut down automatically at 1856 because of high water levels in the well.

TABLE A2 (Continued)

**OPERATION AND MAINTENANCE SUMMARY
NOVOCs™ SITE Demonstration
Site 9, NAS North Island, California**

DATE	DESCRIPTION
06/11/98	The submergence of the air diffuser was set back to 9.5 feet below the water table and the NOVOCs™ system was restarted at 1557.
06/19/98	The NOVOCs™ system was shut down at 1926 because of high water levels in the well. The NOVOCs™ system was restarted remotely at 2006 and ran for 3 minutes before it was shut down again because of high water level.
06/22/98	An attempt to restart the NOVOCs™ system remotely was made at 0912; however, the NOVOCs™ system experienced an immediate shutdown because the Thermatrix system was down. The Thermatrix system was checked; however, no problems were identified.
06/24/98	Additional efforts to restart the Thermatrix system were unsuccessful. The valve on the Thermatrix skid that opens to accept vapors from the NOVOCs™ system was not opening when attempts to restart the system were made.
08/27/98	Installation of the redesigned NOVOCs™ system was complete.
09/24/98	The redesigned NOVOCs™ system began operation.
09/26/98	The NOVOCs™ system was shut down because of a low volume of acid in the storage tank. The acid tank was switched out and the NOVOCs™ system was restarted at 0830. The NOVOCs™ system was shut down again at 2000 because the Thermatrix system was not operating properly.
09/29/98	The NOVOCs™ and Thermatrix systems were restarted at 2000. The NOVOCs™ system was shut down at 2100 because of a high blower temperature.
09/30/98	The NOVOCs™ system was restarted.
10/03/98 through 10/05/98	NOVOCs™ system was shut down because of high water levels in the well.
10/06/98 through 10/07/98	The submergence of the air diffuser line was increased by about 2 feet and the NOVOCs™ system was restarted. The NOVOCs™ system was shut down because of high water levels in the well.
10/08/98	The NOVOCs™ system was restarted at about 1200 on October 8, 1998. Water levels in the shallow piezometer showed a progressive increase from 3.5 feet bgs on October 8, 1998, to ground surface on October 11, 1998.
10/11/98	The NOVOCs™ system was shut down because of high water levels in the well. When the NOVOCs™ system was restarted, the Thermatrix system shut down because pH levels were outside of control limits.

TABLE A2 (Continued)

**OPERATION AND MAINTENANCE SUMMARY
NOVOCs™ SITE Demonstration
Site 9, NAS North Island, California**

DATE	DESCRIPTION
10/12/98	The Thermatrix system was inspected by the developer. The NoVOCs™ and Thermatrix systems were restarted at 1130.
10/13/98	The NoVOCs™ system was shut down at 1500 because of low quench levels in the Thermatrix system.
10/14/98	The Thermatrix system was repaired and the NoVOCs™ system was restarted. The water level in the return piezometer was observed about 6 inches above the top of the piezometer, indicating a pumping rate of about 22 to 25 gpm.
10/15/98	The NoVOCs™ system was shut down because the municipal water supply to the Thermatrix system had been turned off.
10/16/98	The water supply to the Thermatrix system was reestablished and the NoVOCs™ and Thermatrix systems were restarted.
10/18/98	The NoVOCs™ system was shut down because of high water levels in the well.
10/19/98	The NoVOCs™ system was restarted at 1030. Numerous high-level water alarms were reported throughout the day. The NoVOCs™ system was shut down at 1430 to raise the air diffuser about 1.5 feet. The NoVOCs™ system was restarted at 1500.
10/20/98	The NoVOCs™ system was shut down because of high water levels in the well. The high water-level float switch was removed from the interior of the NoVOCs™ well. A 2-inch-diameter PVC pipe was adapted onto the 0.5-inch-diameter return piezometer. The float switch was placed in the 2-inch-diameter PVC pipe at a height of about 3 feet above grade. During this modification a steady stream of water was observed leaving the NoVOCs™ wellhead through the airline that takes VOC-laden vapors to the Thermatrix system. The air injection rate was left at 63 scfm. The NoVOCs™ system was restarted and the air injection rate was slowly reduced until the water level in the return piezometer was just above the ground surface.
10/21/98	Occasional slugs of water were observed leaving the airline that takes VOC-laden vapors to the Thermatrix system. The water level in the return piezometer was visually observed near the float switch height (about 3 feet above grade). The air injection rate was once again lowered until the water level in the return piezometer was just below the ground surface. The flow of water out of the airline stopped after the air injection rate was reduced.
10/22/98	The Thermatrix system was shut down at 1415 because the water injection jets to the scrubber tower were partially clogged. The water jets were repaired and the NoVOCs™ and Thermatrix systems were restarted at 1615.

TABLE A2 (Continued)

**OPERATION AND MAINTENANCE SUMMARY
NOVOCs™ SITE Demonstration
Site 9, NAS North Island, California**

DATE	DESCRIPTION
10/27/98	The NoVOCs™ system was shut down at 0940 because of rising water levels in the well. The pH eductor pipe was removed for inspection. A slimy light orange stain was present over almost the entire length of the pipe, suggesting that iron fouling occurred, causing a reduction of water flow back into the formational sands.
10/28/98	The NoVOCs™ system was restarted.
10/29/98	The NoVOCs™ system was shut down at 0800. A bromide/chloride solution was injected in the well. The NoVOCs™ system was restarted to conduct system observations and inspection. The NoVOCs™ system was shut down at 1700.
10/30/98	The NoVOCs™ system was operated briefly and was shut down because of high water levels in the well.
11/30/98 through 12/04/98	Internal well components were removed for inspection and maintenance. The NoVOCs™ system was restarted after reinstallation of the internal components on December 4, 1998. During operation, about 5 gallons of hydrochloric acid were injected into the well, which lowered the pH to 1 to 2 in the well.
12/05/98	The NoVOCs™ system was shut down from 1100 to 1600 to make repairs on the Thermatrix system. Citric acid and minor amounts of hydrochloric acid were injected into the well to maintained the pH level at 4 to 6.
12/07/98	The NoVOCs™ system was shut down at 1100 because of problems with ignition of the Thermatrix system pilot flame.
12/09/98	The Thermatrix system was repaired and the NoVOCs™ system restarted at 1900.
12/10/98	The Thermatrix system was shut down for maintenance by the developer. The NoVOCs™ and Thermatrix systems were restarted at 1630.
12/11/98	The NoVOCs™ system was shut down briefly during the day to check remote system controls.
12/17/98 through 12/23/98	The pH was lowered three times using hydrochloric acid, for a total of 10 hours of run time at a pH of 1.5. This was done to see if the lowered pH would help lower the water level in the recharge piezometer by removing potential iron precipitation (this did not reduce the water level in the return piezometer). About 35 gallons of the bromine/chlorine solution was added to the intake piezometer on December 22, 1998.
12/24/98	The NoVOCs™ system was shut down at 0200 because the Thermatrix system went off line. Thermatrix system was repaired and both systems were restarted at 0615.
12/26/98	The NoVOCs™ system was shut down at 1600 because of high pH levels at the well. Batteries for pH pre-amplifier were replaced and the NoVOCs™ system was restarted.

TABLE A2 (Continued)

**OPERATION AND MAINTENANCE SUMMARY
NOVOCs™ SITE Demonstration
Site 9, NAS North Island, California**

DATE	DESCRIPTION
12/29/98	The NoVOCs™ system was shut down at 1630 because of high water levels in the well. Water was also observed exiting the wellhead through the interior of the airline leading to the Thermatrix system.
12/30/98	<p>The water trapped in the airlines was blown out using the NoVOCs™ blower. About 5 gallons of water was removed from the airline system. In addition, water samples were collected from the upper recharge screen. White biological material was pumped from the recharge screen, which likely plugged the screen and caused the observed high water levels in the well.</p> <p>In an attempt to mitigate biofouling of the well screen, a bromide/chloride solution and hydrogen peroxide were added to the well. About 4 gallons of 3 percent hydrogen peroxide solution and 5 gallons of 35 percent solution were used. About 10 gallons of the bromide/chloride solution was added to the well. The solutions were added to the annulus of the well, recharge piezometer, and intake piezometer. After the injections, the NoVOCs™ system was restarted at 1615 and was able to maintain a pumping rate of 10 gpm.</p>
01/03/98	The NoVOCs™ system was shut down at 1200 because the Thermatrix system went off line. The NoVOCs™ and Thermatrix systems were restarted at 1700.
01/04/99	The NoVOCs™ system was shut down because of high water levels in the well. The high water level shutdown was accompanied by a small increase in water level in the shallow piezometer. This information appeared to suggest that biofouling of the recharge screen had occurred again. Based on this information, the Navy decided to terminate the demonstration.

TABLE A3

FIELD PARAMETER SUMMARY - CONDUCTIVITY
NoVOCs™ SITE Demonstration
Site 9, NAS North Island, California

Well	Description	Conductivity (Fmhos/cm x 10 ³)							
		Bechtel Baseline 2/6-12/98	Tetra Tech Baseline 4/17/98	Tetra Tech Week 1 4/28/98	Tetra Tech Week 2 5/6/98	Tetra Tech Week 3 5/12/98	Tetra Tech 1st Monthly 6/8-10/98	Bechtel 6/8-15/98	Tetra Tech 2 nd Baseline 9/8/98
PZ-01	Effluent System Well	NA	34.5	37.6	50.0	*	45.5	45.5	33.8
PZ-02	Influent System Well	NA	35.2	38.8	50.3	*	50.3	33.5	44.8
MW-45	Shallow Well	17.4	19.9	NA	NA	NA	26.6	21.0	25.8
MW-46	Intermediate Well	14.4	30.3	NA	NA	NA	42.9	31.9	43.2
MW-47	Deep Well	18.3	36.4	NA	NA	NA	45.9	34.1	46.5
MW-48	Shallow Well	22.7	29.4	NA	NA	NA	38.5	29.5	38.7
MW-49	Deep Well	23.9	34.0	NA	NA	NA	41.8	30.8	43.8
MW-50	Intermediate Well	25.2	31.2	NA	NA	NA	35.2	29.2	41.9
MW-51	Intermediate Well	25.3	31.5	NA	NA	NA	44.6	29.8	41.5
MW-52	Shallow Well	20.1	23.2	NA	NA	NA	35.1	35.2	32.3
MW-53	Deep Well	25.7	NA ⁽¹⁾	NA	NA	NA	51.9	NA	47.3
MW-54	Fully Penetrating Well	NA	NA ⁽²⁾	NA	NA	NA	28.2	NA	40.8

Notes:

Fmhos/cm

Micromhos per centimeter

NA

Not analyzed

*

The data were collected; however, due to severe weather conditions (high winds), the data were lost and could not be recovered.

(1)

Monitoring well MW-53 was not sampled because of a malfunctioning bladder pump.

(2)

Monitoring well MW-54 was not sampled because of the presence of the multi-level diffusion sampler in the well.

TABLE A4

FIELD PARAMETER SUMMARY - DISSOLVED OXYGEN
NoVOCs™ SITE Demonstration
Site 9, NAS North Island, California

Well	Description	Dissolved Oxygen (mg/L)							
		Bechtel Baseline 2/6-12/98	Tetra Tech Baseline 4/17/98	Tetra Tech Week 1 4/28/98	Tetra Tech Week 2 5/6/98	Tetra Tech Week 3 5/12/98	Tetra Tech 1st Monthly 6/8-10/98	Bechtel 6/8-15/98	Tetra Tech 2 nd Baseline 9/8/98
PZ-01	Effluent System Well	NA	10.31	9.10	9.44	*	7.02	7	8.97
PZ-02	Influent System Well	NA	9.75	8.66	9.96	*	9.05	6.25	8.93
MW-45	Shallow Well	1.5	9.90	NA	NA	NA	9.43	5.5	9.72
MW-46	Intermediate Well	2.0	10.50	NA	NA	NA	9.98	6.7	9.98
MW-47	Deep Well	3.0	9.61	NA	NA	NA	10.3	4.76	9.01
MW-48	Shallow Well	2.25	10.10	NA	NA	NA	10.2	3.85	9.25
MW-49	Deep Well	5.0	9.66	NA	NA	NA	9.21	2.75	8.77
MW-50	Intermediate Well	1.75	9.91	NA	NA	NA	9.48	2.8	9.04
MW-51	Intermediate Well	1.25	8.28	NA	NA	NA	8.97	3.8	8.88
MW-52	Shallow Well	2.8	10.01	NA	NA	NA	9.97	10.09	9.61
MW-53	Deep Well	2.25	NA ⁽¹⁾	NA	NA	NA	10.1	NA	9.60
MW-54	Fully Penetrating Well	NA	NA ⁽²⁾	NA	NA	NA	9.57	NA	8.79

Notes:

mg/L Milligrams per liter

NA Not analyzed

* The data were collected; however, due to severe weather conditions (high winds), the data were lost and could not be recovered.

(1) Monitoring well MW-53 was not sampled because of a malfunctioning bladder pump.

(2) Monitoring well MW-54 was not sampled because of the presence of the multi-level diffusion sampler in the well.

TABLE A5

**FIELD PARAMETER SUMMARY - pH
NoVOCs™ SITE Demonstration
Site 9, NAS North Island, California**

Well	Description	pH							
		Bechtel Baseline 2/6-12/98	Tetra Tech Baseline 4/17/98	Tetra Tech Week 1 4/28/98	Tetra Tech Week 2 5/6/98	Tetra Tech Week 3 5/12/98	Tetra Tech 1st Monthly 6/8-10/98	Bechtel 6/8-15/98	Tetra Tech 2 nd Baseline 9/8/98
PZ-01	Effluent System Well	NA	7.36	7.14	8.26	*	7.17	7.44	7.26
PZ-02	Influent System Well	NA	7.53	6.71	7.25	*	7.01	6.88	7.17
MW-45	Shallow Well	7.17	8.13	NA	NA	NA	7.35	7.37	7.44
MW-46	Intermediate Well	7.10	7.72	NA	NA	NA	7.28	7.2	7.15
MW-47	Deep Well	6.71	7.52	NA	NA	NA	6.95	6.95	6.83
MW-48	Shallow Well	7.29	7.92	NA	NA	NA	7.14	7.15	7.12
MW-49	Deep Well	7.38	8.13	NA	NA	NA	7.11	7.26	7.26
MW-50	Intermediate Well	7.32	7.77	NA	NA	NA	7.21	7.22	7.16
MW-51	Intermediate Well	7.20	7.53	NA	NA	NA	7.15	7.11	7.08
MW-52	Shallow Well	7.54	8.24	NA	NA	NA	7.44	7.45	7.39
MW-53	Deep Well	6.84	NA ⁽¹⁾	NA	NA	NA	6.85	NA	6.69
MW-54	Fully Penetrating Well	NA	NA ⁽²⁾	NA	NA	NA	7.13	NA	6.88

Notes:

NA Not analyzed

* The data were collected; however, due to severe weather conditions (high winds), the data were lost and could not be recovered.

(1) Monitoring well MW-53 was not sampled because of a malfunctioning bladder pump.

(2) Monitoring well MW-54 was not sampled because of the presence of the multi-level diffusion sampler in the well.

TABLE A6

**FIELD PARAMETER SUMMARY - REDUCTION/OXIDATION POTENTIAL
NoVOCs™ SITE Demonstration
Site 9, NAS North Island, California**

Well	Description	Reduction/Oxidation Potential (mV)							
		Bechtel Baseline 2/6-12/98	Tetra Tech Baseline 4/17/98	Tetra Tech Week 1 4/28/98	Tetra Tech Week 2 5/6/98	Tetra Tech Week 3 5/12/98	Tetra Tech 1st Monthly 6/8-10/98	Bechtel 6/8-15/98	Tetra Tech 2 nd Baseline 9/8/98
PZ-01	Effluent System Well	NA	NA	NA	NA	NA	NA	105	120
PZ-02	Influent System Well	NA	NA	NA	NA	NA	NA	97	150
MW-45	Shallow Well	125	NA	NA	NA	NA	NA	95	157
MW-46	Intermediate Well	115	NA	NA	NA	NA	NA	111	151
MW-47	Deep Well	74	NA	NA	NA	NA	NA	87	126
MW-48	Shallow Well	9	NA	NA	NA	NA	NA	90	165
MW-49	Deep Well	-77	NA	NA	NA	NA	NA	4	136
MW-50	Intermediate Well	91	NA	NA	NA	NA	NA	-0.007	122
MW-51	Intermediate Well	81	NA	NA	NA	NA	NA	96	135
MW-52	Shallow Well	65	NA	NA	NA	NA	NA	NA	147
MW-53	Deep Well	22	NA ⁽¹⁾	NA	NA	NA	NA	NA	156
MW-54	Fully Penetrating Well	NA	NA ⁽²⁾	NA	NA	NA	NA	NA	140

Notes:

mV Millivolts

NA Not analyzed

⁽¹⁾ Monitoring well MW-53 was not sampled because of a malfunctioning bladder pump.

⁽²⁾ Monitoring well MW-54 was not sampled because of the presence of the multi-level diffusion sampler in the well.

TABLE A7

**FIELD PARAMETER SUMMARY - SALINITY
NoVOCs™ SITE Demonstration
Site 9, NAS North Island, California**

Well	Description	Salinity (percent)							
		Bechtel Baseline 2/6-12/98	Tetra Tech Baseline 4/17/98	Tetra Tech Week 1 4/28/98	Tetra Tech Week 2 5/6/98	Tetra Tech Week 3 5/12/98	Tetra Tech 1st Monthly 6/8-10/98	Bechtel 6/8/-1598	Tetra Tech 2 nd Baseline 9/8/98
PZ-01	Effluent System Well	NA	2.19	2.38	3.28	*	2.95	NA	2.13
PZ-02	Influent System Well	NA	2.22	2.47	3.31	*	3.05	NA	2.90
MW-45	Shallow Well	NA	1.19	NA	NA	NA	1.64	NA	1.58
MW-46	Intermediate Well	NA	1.89	NA	NA	NA	2.82	NA	2.80
MW-47	Deep Well	NA	2.31	NA	NA	NA	2.99	NA	3.03
MW-48	Shallow Well	NA	1.82	NA	NA	NA	2.46	NA	2.47
MW-49	Deep Well	NA	2.14	NA	NA	NA	2.71	NA	2.84
MW-50	Intermediate Well	NA	1.96	NA	NA	NA	2.27	NA	2.70
MW-51	Intermediate Well	NA	1.96	NA	NA	NA	2.93	NA	2.67
MW-52	Shallow Well	NA	1.41	NA	NA	NA	2.23	NA	2.03
MW-53	Deep Well	NA	NA ⁽¹⁾	NA	NA	NA	3.44	NA	3.08
MW-54	Fully Penetrating Well	NA	NA ⁽²⁾	NA	NA	NA	1.74	NA	2.60

Notes:

NA Not analyzed

* The data were collected; however, due to severe weather conditions (high winds), the data were lost and could not be recovered.

(1) Monitoring well MW-53 was not sampled because of a malfunctioning bladder pump.

(2) Monitoring well MW-54 was not sampled because of the presence of the multi-level diffusion sampler in the well.

TABLE A8

**FIELD PARAMETER SUMMARY - TEMPERATURE
NoVOCs™ SITE Demonstration
Site 9, NAS North Island, California**

Well	Description	Temperature (EC)							
		Bechtel Baseline 2/6-12/98	Tetra Tech Baseline 4/17/98	Tetra Tech Week 1 4/28/98	Tetra Tech Week 2 5/6/98	Tetra Tech Week 3 5/12/98	Tetra Tech 1st Monthly 6/8-10/98	Bechtel 6/8-15/98	Tetra Tech 2 nd Baseline 9/8/98
PZ-01	Effluent System Well	NA	21.4	19.3	21.0	*	19.0	19.0	21.2
PZ-02	Influent System Well	NA	20.4	20.3	21.2	*	19.8	20.7	21.8
MW-45	Shallow Well	18.1	20.7	NA	NA	NA	20.3	20.7	22.3
MW-46	Intermediate Well	19.2	20.8	NA	NA	NA	21.1	21.0	21.6
MW-47	Deep Well	18.1	21.0	NA	NA	NA	21.3	21.5	21.6
MW-48	Shallow Well	19.8	21.1	NA	NA	NA	21.6	21.8	21.2
MW-49	Deep Well	20.2	20.6	NA	NA	NA	20.6	22.0	21.9
MW-50	Intermediate Well	21.3	21.0	NA	NA	NA	21.1	21.7	21.5
MW-51	Intermediate Well	20.7	20.8	NA	NA	NA	21.5	22.1	21.5
MW-52	Shallow Well	20.6	20.7	NA	NA	NA	21.1	21.0	20.9
MW-53	Deep Well	18.5	NA ⁽¹⁾	NA	NA	NA	20.4	NA	20.8
MW-54	Fully Penetrating Well	NA	NA ⁽²⁾	NA	NA	NA	20.9	NA	21.6

Notes:

NA Not analyzed

* The data were collected; however, due to severe weather conditions (high winds), the data were lost and could not be recovered.

(1) Monitoring well MW-53 was not sampled because of a malfunctioning bladder pump.

(2) Monitoring well MW-54 was not sampled because of the presence of the multi-level diffusion sampler in the well.

TABLE A9

GEOCHEMICAL SUMMARY - ALKALINITY
NoVOCs™ SITE Demonstration
Site 9, NAS North Island, California

Well	Description	Alkalinity (mg/L)			
		Bechtel Baseline 2/6-12/98	Tetra Tech Baseline 4/17/98	Bechtel 6/8-15/98	Tetra Tech 2 nd Baseline 9/8/98
PZ-01	Effluent System Well	NA	380	NA	270
PZ-02	Influent System Well	NA	140	NA	280
MW-45	Shallow Well	638	710	736	820
MW-46	Intermediate Well	314	230	252	280
MW-47	Deep Well	417	430	338	390
MW-48	Shallow Well	304	330	344	330
MW-49	Deep Well	293	320	313	320
MW-50	Intermediate Well	281	310	296	310
MW-51	Intermediate Well	269	140	302	320
MW-52	Shallow Well	320	160	358	370
MW-53	Deep Well	451	NA ⁽¹⁾	358	440
MW-54	Fully Penetrating Well	NA	NA ⁽²⁾	NA	520

Notes:

mg/L Milligrams per liter

NA Not analyzed

⁽¹⁾ Monitoring well MW-53 was not sampled because of a malfunctioning bladder pump.

⁽²⁾ Monitoring well MW-54 was not sampled because of the presence of the multi-level diffusion sampler in the well.

TABLE A10

GEOCHEMICAL SUMMARY - TOTAL DISSOLVED SOLIDS
NoVOCs™ SITE Demonstration
Site 9, NAS North Island, California

Well	Description	Total Dissolved Solids (mg/L x 10 ³)			
		Bechtel Baseline 2/6-12/98	Tetra Tech Baseline 4/17/98	Bechtel 6/8-15/98	Tetra Tech 2 nd Baseline 9/8/98
PZ-01	Effluent System Well	NA	35.0	NA	29.0
PZ-02	Influent System Well	NA	35.0	NA	37.0
MW-45	Shallow Well	17.6	18.0	17.2	10.0
MW-46	Intermediate Well	27.3	30.0	28.4	41.0
MW-47	Deep Well	32.0	35.0	31.1	35.0
MW-48	Shallow Well	25.7	26.0	25.3	31.0
MW-49	Deep Well	29.2	31.0	28.6	31.0
MW-50	Intermediate Well	27.3	31.0	28.4	38.0
MW-51	Intermediate Well	27.0	31.0	27.6	38.0
MW-52	Shallow Well	22.7	24.0	21.4	31.0
MW-53	Deep Well	31.0	NA ⁽¹⁾	21.4	38.0
MW-54	Fully Penetrating Well	NA	NA ⁽²⁾	NA	40.0

Notes:

mg/L Milligrams per liter

NA Not analyzed

⁽¹⁾ Monitoring well MW-53 was not sampled because of a malfunctioning bladder pump.⁽²⁾ Monitoring well MW-54 was not sampled because of the presence of the multi-level diffusion sampler in the well.

TABLE A11

**GEOCHEMICAL SUMMARY
TOTAL ORGANIC CARBON AND DISSOLVED ORGANIC CARBON
NoVOCs™ SITE Demonstration
Site 9, NAS North Island, California**

Well	Description	TOC (mg/L)		DOC (mg/L)	
		Bechtel Baseline 2/6-12/98	Bechtel 6/8-15/98	Tetra Tech Baseline 4/17/98	Tetra Tech 2 nd Baseline 9/8/98
PZ-01	Effluent System Well	NA	NA	1	2
PZ-02	Influent System Well	NA	NA	1	2
MW-45	Shallow Well	16.1	18.2	12	14
MW-46	Intermediate Well	5.5	3.4	2	2
MW-47	Deep Well	3.4	3.0	2	2
MW-48	Shallow Well	7.8	5.9	3	4
MW-49	Deep Well	4.3	4.8	2	3
MW-50	Intermediate Well	5.3	5.8	2	3
MW-51	Intermediate Well	4.6	4.6	2	3
MW-52	Shallow Well	6.2	6.5	2	*
MW-53	Deep Well	3.1	6.5	NA ⁽¹⁾	2
MW-54	Fully Penetrating Well	NA	NA	NA ⁽²⁾	9

Notes:

mg/L Milligrams per liter

TOC Total organic carbon

DOC Dissolved organic carbon

NA Not analyzed

* Analytical results for DOC were not available because the sample container was broken during transport.

(1) Monitoring well MW-53 was not sampled because of a malfunctioning bladder pump.

(2) Monitoring well MW-54 was not sampled because of the presence of the multi-level diffusion sampler in the well.

TABLE A12

**SEMIVOLATILE ORGANIC COMPOUND SUMMARY — 1,2-DICHLOROBENZENE
NoVOCs™ SITE Demonstration
Site 9, NAS North Island, California**

Well	Description	1,2-Dichlorobenzene (Fg/L)			
		Bechtel Baseline 2/6-12/98	Tetra Tech Baseline 4/17/98	Bechtel 6/8-15/98	Tetra Tech 2 nd Baseline 9/8/98
PZ-01	Effluent System Well	NA	<10	NA	<310
PZ-02	Influent System Well	NA	<10	NA	<310
MW-45	Shallow Well	82	26	20 J	<500
MW-46	Intermediate Well	74	22	6 J	<150
MW-47	Deep Well	30 J	23	<250	<330
MW-48	Shallow Well	200 D	150	300	<10
MW-49	Deep Well	<0.7	<10	<10	210
MW-50	Intermediate Well	3 J	3.2 J	5 J	<50
MW-51	Intermediate Well	9.9	12	26	<150
MW-52	Shallow Well	52 D	58	110	73 J
MW-53	Deep Well	40 JD	NA ⁽¹⁾	<250	73 J
MW-54	Fully Penetrating Well	NA	NA ⁽²⁾	NA	<3,300

Notes:

Fg/L Micrograms per liter

NA Not analyzed

< Less than

D Laboratory qualifier identifies compounds in an analysis at a secondary dilution factor

J Laboratory qualifier indicates that the associated numerical value is an estimate

⁽¹⁾ Monitoring well MW-53 was not sampled because of a malfunctioning bladder pump.

⁽²⁾ Monitoring well MW-54 was not sampled because of the presence of the multi-level diffusion sampler in the well.

TABLE A13

METALS SUMMARY - ALUMINUM
NoVOCs™ SITE Demonstration
Site 9, NAS North Island, California

Well	Description	Aluminum (Fg/L)			
		Bechtel Baseline 2/6-12/98	Tetra Tech Baseline 4/17/98	Bechtel 6/8-15/98	Tetra Tech 2 nd Baseline 9/8/98
PZ-01	Effluent System Well	NA	230	NA	<200
PZ-02	Influent System Well	NA	<200	NA	<200
MW-45	Shallow Well	35.4 B	<200	29.6 B	<200
MW-46	Intermediate Well	43.5 B	<200	18.8 B	<200
MW-47	Deep Well	37.5 B	<200	25.1 B	<200
MW-48	Shallow Well	17.4 B	<200	24.8 B	<200
MW-49	Deep Well	13.9 B	<200	24.4 B	<200
MW-50	Intermediate Well	17.6 B	235	50.7 B	<200
MW-51	Intermediate Well	20.0 B	<200	27.6 B	<200
MW-52	Shallow Well	19.6 B	<200	17.7 B	<200
MW-53	Deep Well	35.5 B	NA ⁽¹⁾	17.7 B	<200
MW-54	Fully Penetrating Well	NA	NA ⁽²⁾	NA	<200

Notes:

Fg/L Micrograms per liter

NA Not analyzed

< Less than

B Value is less than the IDL, but greater than or equal to CRDL

⁽¹⁾ Monitoring well MW-53 was not sampled because of a malfunctioning bladder pump.

⁽²⁾ Monitoring well MW-54 was not sampled because of the presence of the multi-level diffusion sampler in the well.

TABLE A14

**METALS SUMMARY - ANTIMONY
NoVOCs™ SITE Demonstration
Site 9, NAS North Island, California**

Well	Description	Antimony (Fg/L)			
		Bechtel Baseline 2/6-12/98	Tetra Tech Baseline 4/17/98	Bechtel 6/8-15/98	Tetra Tech 2 nd Baseline 9/8/98
PZ-01	Effluent System Well	NA	68	NA	<60
PZ-02	Influent System Well	NA	<60	NA	<60
MW-45	Shallow Well	29.1 B	<60	31.7 B	<60
MW-46	Intermediate Well	38.7 B	<60	17.9 B	<60
MW-47	Deep Well	30.4 B	<60	35.8 B	<60
MW-48	Shallow Well	22.2 B	<60	33.4 B	<60
MW-49	Deep Well	29.4 B	<60	35.0 B	65.9
MW-50	Intermediate Well	19.0 B	<60	32.6 B	62.6
MW-51	Intermediate Well	17.2 B	<60	18.8 B	80.8
MW-52	Shallow Well	21.7 B	<60	38.4 B	<60
MW-53	Deep Well	26.9 B	NA ⁽¹⁾	38.4 B	65.3
MW-54	Fully Penetrating Well	NA	NA ⁽²⁾	NA	<60

Notes:

Fg/L Micrograms per liter

NA Not analyzed

< Less than

B Value is less than the instrument detection limit, but greater than or equal to the contract required detection limit

⁽¹⁾ Monitoring well MW-53 was not sampled because of a malfunctioning bladder pump.

⁽²⁾ Monitoring well MW-54 was not sampled because of the presence of the multi-level diffusion sampler in the well.

TABLE A15

**METALS SUMMARY - ARSENIC
NoVOCs™ SITE Demonstration
Site 9, NAS North Island, California**

Well	Description	Arsenic (Fg/L)			
		Bechtel Baseline 2/6-12/98	Tetra Tech Baseline 4/17/98	Bechtel 6/8-15/98	Tetra Tech 2 nd Baseline 9/8/98
PZ-01	Effluent System Well	NA	<100	NA	<200
PZ-02	Influent System Well	NA	<100	NA	<200
MW-45	Shallow Well	2.8 BWN	<100	3.6 BWN	<200
MW-46	Intermediate Well	3.6 BWN	<100	1.8 BWN	<200
MW-47	Deep Well	37.0 SN	<100	30.6 SN	<200
MW-48	Shallow Well	1 UWN	<100	2.6 BWN	<200
MW-49	Deep Well	1 UWN	<100	1.9 BWN	<200
MW-50	Intermediate Well	3.8 BWN	<100	2.5 BWN	<200
MW-51	Intermediate Well	2.0 BWN	<100	2.0 BWN	<200
MW-52	Shallow Well	1.6 BWN	<100	2.0 BWN	<200
MW-53	Deep Well	42.5 SN	NA ⁽¹⁾	2.0 BWN	<200
MW-54	Fully Penetrating Well	NA	NA ⁽²⁾	NA	<200

Notes:

Fg/L Micrograms per liter

NA Not analyzed

< Less than

BWN Value is less than the instrument detection limit, but greater than or equal to the contract required detection limit, post digestion spike and spiked sample recovery not within control limits

SN Reported value determined by Method of Standard additions and spiked sample recovery not within control limits

UWN Concentration below detection limit (detection limit reported next to UWN), spiked sample recovery and post digestion spike not within control limits

⁽¹⁾ Monitoring well MW-53 was not sampled because of a malfunctioning bladder pump.

⁽²⁾ Monitoring well MW-54 was not sampled because of the presence of the multi-level diffusion sampler in the well.

TABLE A16

**METALS SUMMARY - BERYLLIUM
NoVOCs™ SITE Demonstration
Site 9, NAS North Island, California**

Well	Description	Beryllium (Fg/L)			
		Bechtel Baseline 2/6-12/98	Tetra Tech Baseline 4/17/98	Bechtel 6/8-15/98	Tetra Tech 2 nd Baseline 9/8/98
PZ-01	Effluent System Well	NA	<5.0	NA	<5.0
PZ-02	Influent System Well	NA	<5.0	NA	<5.0
MW-45	Shallow Well	0.41 B	<5.0	0.83 B	<5.0
MW-46	Intermediate Well	0.56 B	<5.0	1.10 B	<5.0
MW-47	Deep Well	0.3 U	<5.0	0.54 B	<5.0
MW-48	Shallow Well	0.3 U	<5.0	0.54 B	<5.0
MW-49	Deep Well	0.3 U	<5.0	0.2 U	<5.0
MW-50	Intermediate Well	0.3 U	<5.0	0.2 U	<5.0
MW-51	Intermediate Well	0.3 U	<5.0	0.2 U	<5.0
MW-52	Shallow Well	0.3 U	<5.0	0.84 B	<5.0
MW-53	Deep Well	0.3 U	NA ⁽¹⁾	0.84 B	<5.0
MW-54	Fully Penetrating Well	NA	NA ⁽²⁾	NA	<5.0

Notes:

Fg/L Micrograms per liter

NA Not analyzed

< Less than

B Value is less than the instrument detection limit, but greater than or equal to the contract required reporting limit

U Concentration below detection limit (detection limit reported next to U)

⁽¹⁾ Monitoring well MW-53 was not sampled because of a malfunctioning bladder pump.

⁽²⁾ Monitoring well MW-54 was not sampled because of the presence of the multi-level diffusion sampler in the well.

TABLE A17

**METALS SUMMARY - BARIUM
NoVOCs™ SITE Demonstration
Site 9, NAS North Island, California**

Well	Description	Barium (Fg/L)			
		Bechtel Baseline 2/6-12/98	Tetra Tech Baseline 4/17/98	Bechtel 6/8-15/98	Tetra Tech 2 nd Baseline 9/8/98
PZ-01	Effluent System Well	NA	<200	NA	<200
PZ-02	Influent System Well	NA	<200	NA	<200
MW-45	Shallow Well	81.7 BE	<200	75.6 B	<200
MW-46	Intermediate Well	50.3 BE	<200	61.1 B	<200
MW-47	Deep Well	56.2 BE	<200	43.8 B	<200
MW-48	Shallow Well	75.2 BE	<200	60.7 B	<200
MW-49	Deep Well	53.1 BE	<200	40.6 B	<200
MW-50	Intermediate Well	49.3 B	<200	43.8 B	<200
MW-51	Intermediate Well	59.6 BE	<200	41.9 B	<200
MW-52	Shallow Well	96.0 BE	<200	80.4 B	<200
MW-53	Deep Well	58.0 BE	NA ⁽¹⁾	80.4 B	<200
MW-54	Fully Penetrating Well	NA	NA ⁽²⁾	NA	<200

Notes:

Fg/L Micrograms per liter

NA Not analyzed

< Less than

BE Value is less than the instrument detection limit, but greater than or equal to the contract required detection limit and value estimated due to interference

B Value is less than the instrument detection limit, but greater than or equal to the contract required detection limit

⁽¹⁾ Monitoring well MW-53 was not sampled because of a malfunctioning bladder pump.

⁽²⁾ Monitoring well MW-54 was not sampled because of the presence of the multi-level diffusion sampler in the well.

TABLE A18

**METALS SUMMARY - CADMIUM
NoVOCs™ SITE Demonstration
Site 9, NAS North Island, California**

Well	Description	Cadmium (Fg/L)			
		Bechtel Baseline 2/6-12/98	Tetra Tech Baseline 4/17/98	Bechtel 6/8-15/98	Tetra Tech 2 nd Baseline 9/8/98
PZ-01	Effluent System Well	NA	<5.0	NA	<5.0
PZ-02	Influent System Well	NA	<5.0	NA	<5.0
MW-45	Shallow Well	2.5 U	<5.0	4.4 B	<5.0
MW-46	Intermediate Well	3.6 B	<5.0	4.4 B	<5.0
MW-47	Deep Well	2.5 U	<5.0	3.8 U	<5.0
MW-48	Shallow Well	4.7 U	<5.0	3.8 U	<5.0
MW-49	Deep Well	4.0 B	<5.0	3.8 U	<5.0
MW-50	Intermediate Well	2.5 U	<5.0	3.8 U	<5.0
MW-51	Intermediate Well	3.6 B	<5.0	4.7 B	<5.0
MW-52	Shallow Well	3.0 B	<5.0	6.4	<5.0
MW-53	Deep Well	2.6 B	NA ⁽¹⁾	6.4	<5.0
MW-54	Fully Penetrating Well	NA	NA ⁽²⁾	NA	<5.0

Notes:

Fg/L Micrograms per liter

NA Not analyzed

< Less than

U Concentration below detection limit (detection limit reported next to U)

B Value is less than the instrument detection limit, but greater than or equal to the contract required detection limit

⁽¹⁾ Monitoring well MW-53 was not sampled because of a malfunctioning bladder pump.

⁽²⁾ Monitoring well MW-54 was not sampled because of the presence of the multi-level diffusion sampler in the well.

TABLE A19

**METALS SUMMARY - CALCIUM
NoVOCs™ SITE Demonstration
Site 9, NAS North Island, California**

Well	Description	Calcium (mg/L)			
		Bechtel Baseline 2/6-12/98	Tetra Tech Baseline 4/17/98	Bechtel 6/8-15/98	Tetra Tech 2 nd Baseline 9/8/98
PZ-01	Effluent System Well	NA	500	NA	315
PZ-02	Influent System Well	NA	500	NA	446
MW-45	Shallow Well	199 E	220	213	5
MW-46	Intermediate Well	270 E	330	402	379
MW-47	Deep Well	422 E	510	401	453
MW-48	Shallow Well	292 E	340	306	306
MW-49	Deep Well	319 E	390	362	359
MW-50	Intermediate Well	321 E	410	349	337
MW-51	Intermediate Well	336 E	410	390	379
MW-52	Shallow Well	273 E	320	298	293
MW-53	Deep Well	423 E	NA ⁽¹⁾	298	494
MW-54	Fully Penetrating Well	NA	NA ⁽²⁾	NA	336

Notes:

mg/L Milligrams per liter

NA Not analyzed

E Value estimated due to interference

⁽¹⁾ Monitoring well MW-53 was not sampled because of a malfunctioning bladder pump.

⁽²⁾ Monitoring well MW-54 was not sampled because of the presence of the multi-level diffusion sampler in the well.

TABLE A20

**METALS SUMMARY - CHROMIUM
NoVOCs™ SITE Demonstration
Site 9, NAS North Island, California**

Well	Description	Chromium (Fg/L)			
		Bechtel Baseline 2/6-12/98	Tetra Tech Baseline 4/17/98	Bechtel 6/8-15/98	Tetra Tech 2 nd Baseline 9/8/98
PZ-01	Effluent System Well	NA	<10	NA	<10
PZ-02	Influent System Well	NA	<10	NA	<10
MW-45	Shallow Well	2.8 U	<10	2.4 U	<10
MW-46	Intermediate Well	2.8 U	<10	2.4 U	<10
MW-47	Deep Well	2.8 U	<10	2.4 U	<10
MW-48	Shallow Well	4.2 BN	<10	2.4 U	<10
MW-49	Deep Well	5.2 BN	<10	2.4 U	<10
MW-50	Intermediate Well	7.9 B	<10	2.4 U	<10
MW-51	Intermediate Well	6.5 B	<10	2.4 U	<10
MW-52	Shallow Well	5.4 B	<10	2.4 U	<10
MW-53	Deep Well	10.2 BN	NA ⁽¹⁾	2.4 U	<10
MW-54	Fully Penetrating Well	NA	NA ⁽²⁾	NA	<10

Notes:

Fg/L Micrograms per liter

NA Not analyzed

< Less than

U Concentration below detection limit (detection limit reported next to U)

BN Value is less than the instrument detection limit, but greater than or equal to the contract required reporting limit, spiked sample recovery not within control limits

B Value is less than the instrument detection limit, but greater than or equal to the contract required detection limit

⁽¹⁾ Monitoring well MW-53 was not sampled because of a malfunctioning bladder pump.

⁽²⁾ Monitoring well MW-54 was not sampled because of the presence of the multi-level diffusion sampler in the well.

TABLE A21

**METALS SUMMARY - COBALT
NoVOCs™ SITE Demonstration
Site 9, NAS North Island, California**

Well	Description	Cobalt (Fg/L)			
		Bechtel Baseline 2/6-12/98	Tetra Tech Baseline 4/17/98	Bechtel 6/8-15/98	Tetra Tech 2 nd Baseline 9/8/98
PZ-01	Effluent System Well	NA	<50	NA	<50
PZ-02	Influent System Well	NA	<50	NA	<50
MW-45	Shallow Well	24.2 BN	<50	46.0 B	<50
MW-46	Intermediate Well	11.7 BN	<50	14.2 B	<50
MW-47	Deep Well	10.9 BN	<50	6.0 B	<50
MW-48	Shallow Well	10.9 BN	<50	14.2 B	<50
MW-49	Deep Well	3.9 BN	<50	6.9 B	<50
MW-50	Intermediate Well	3.8 UN	<50	5.6 B	<50
MW-51	Intermediate Well	3.8 UN	<50	7.5 B	<50
MW-52	Shallow Well	5.4 BN	<50	5.4 B	<50
MW-53	Deep Well	12.4 BN	NA ⁽¹⁾	2.4 U	<50
MW-54	Fully Penetrating Well	NA	NA ⁽²⁾	NA	<50

Notes:

Fg/L Micrograms per liter

NA Not analyzed

< Less than

BN Value is less than the instrument detection limit, but greater than or equal to the contract required detection limit, spiked sample recovery not within control limits

B Value is less than the instrument detection limit, but greater than or equal to the contract required detection limit

UN Concentration below detection limit (detection limit reported next to UN) and spiked sample recovery not within control limits

U Concentration below detection limit (detection limit reported next to U)

⁽¹⁾ Monitoring well MW-53 was not sampled because of a malfunctioning bladder pump.

⁽²⁾ Monitoring well MW-54 was not sampled because of the presence of the multi-level diffusion sampler in the well.

TABLE A22

**METALS SUMMARY - COPPER
NoVOCs™ SITE Demonstration
Site 9, NAS North Island, California**

Well	Description	Copper (Fg/L)			
		Bechtel Baseline 2/6-12/98	Tetra Tech Baseline 4/17/98	Bechtel 6/8-15/98	Tetra Tech 2 nd Baseline 9/8/98
PZ-01	Effluent System Well	NA	<25	NA	<25
PZ-02	Influent System Well	NA	<25	NA	<25
MW-45	Shallow Well	2.5 B	<25	2.2 B	<25
MW-46	Intermediate Well	7.3 B	<25	0.8 U	<25
MW-47	Deep Well	1.7 U	<25	0.8 U	<25
MW-48	Shallow Well	9.8 B	<25	0.8 U	<25
MW-49	Deep Well	11.2 B	<25	1.0 B	<25
MW-50	Intermediate Well	6.7 B	<25	1.7 B	<25
MW-51	Intermediate Well	12.8 B	<25	0.8 U	<25
MW-52	Shallow Well	6.5 B	<25	3.0 B	<25
MW-53	Deep Well	1.7 U	NA ⁽¹⁾	3.0 B	<25
MW-54	Fully Penetrating Well	NA	NA ⁽²⁾	NA	<25

Notes:

Fg/L Micrograms per liter

NA Not analyzed

< Less than

B Value is less than the instrument detection limit, but greater than or equal to the contract required detection limit

U Concentration below detection limit (detection limit reported next to U)

⁽¹⁾ Monitoring well MW-53 was not sampled because of a malfunctioning bladder pump.

⁽²⁾ Monitoring well MW-54 was not sampled because of the presence of the multi-level diffusion sampler in the well.

TABLE A23

**METALS SUMMARY - IRON
NoVOCs™ SITE Demonstration
Site 9, NAS North Island, California**

Well	Description	Iron (Fg/L)			
		Bechtel Baseline 2/6-12/98	Tetra Tech Baseline 4/17/98	Bechtel 6/8-15/98	Tetra Tech 2 nd Baseline 9/8/98
PZ-01	Effluent System Well	NA	<100	NA	<100
PZ-02	Influent System Well	NA	<100	NA	1060
MW-45	Shallow Well	91.6 B EN	<100	129 E	<100
MW-46	Intermediate Well	153 EN	<100	183 E	<100
MW-47	Deep Well	248 EN	180	527 E	458
MW-48	Shallow Well	122 EN	<100	173 E	<100
MW-49	Deep Well	147 EN	<100	178 E	<100
MW-50	Intermediate Well	149 EN	<100	196 E	<100
MW-51	Intermediate Well	143 EN	<100	220 E	<100
MW-52	Shallow Well	115 EN	<100	145 E	<100
MW-53	Deep Well	1120 EN	NA ⁽¹⁾	145 E	877
MW-54	Fully Penetrating Well	NA	NA ⁽²⁾	NA	407

Notes:

Fg/L Micrograms per liter

NA Not analyzed

< Less than

B Value is less than the instrument detection limit, but greater than or equal to the contract required detection limit

EN Value estimated due to interference, and spiked sample recovery not within control limits

E Value estimated due to interference

⁽¹⁾ Monitoring well MW-53 was not sampled because of a malfunctioning bladder pump.

⁽²⁾ Monitoring well MW-54 was not sampled because of the presence of the multi-level diffusion sampler in the well.

TABLE A24

**METALS SUMMARY - LEAD
NoVOCs™ SITE Demonstration
Site 9, NAS North Island, California**

Well	Description	Lead (Fg/L)			
		Bechtel Baseline 2/6-12/98	Tetra Tech Baseline 4/17/98	Bechtel 6/8-15/98	Tetra Tech 2 nd Baseline 9/8/98
PZ-01	Effluent System Well	NA	<30	NA	<60
PZ-02	Influent System Well	NA	<30	NA	<60
MW-45	Shallow Well	1.0 BWN	<30	1.0 UWN	<60
MW-46	Intermediate Well	1.6 BWN	<30	5.0 UWN	<60
MW-47	Deep Well	5.0 UWN	<30	5.0 UWN	<60
MW-48	Shallow Well	1.6 BW	<30	5.0 UWN	<60
MW-49	Deep Well	1.7 BW	<30	5.0 UWN	<60
MW-50	Intermediate Well	2.6 BWN	<30	5.0 UWN	<60
MW-51	Intermediate Well	1.4 BWN	<30	5.0 UWN	<60
MW-52	Shallow Well	1.0 B	<30	1.0 UWN	<60
MW-53	Deep Well	2.6 BW	NA ⁽¹⁾	1.0 UWN	<60
MW-54	Fully Penetrating Well	NA	NA ⁽²⁾	NA	<60

Notes:

Fg/L Micrograms per liter

NA Not analyzed

< Less than

BWN Value is less than the instrument detection limit, but greater than or equal to the contract required detection limit, post digestion spike and spiked sample recovery not within control limits

UWN Concentration below detection limit (detection limit reported next to UW), spiked sample recovery and post digestion spike not within control limits

BW Value is less than the instrument detection limit, but greater than or equal to the contract required detection limit, post digestion spike out of control limits

B Value is less than the instrument detection limit, but greater than or equal to the contract required detection limit

⁽¹⁾ Monitoring well MW-53 was not sampled because of a malfunctioning bladder pump.

⁽²⁾ Monitoring well MW-54 was not sampled because of the presence of the multi-level diffusion sampler in the well.

TABLE A25

**METALS SUMMARY - MAGNESIUM
NoVOCs™ SITE Demonstration
Site 9, NAS North Island, California**

Well	Description	Magnesium (mg/L)			
		Bechtel Baseline 2/6-12/98	Tetra Tech Baseline 4/17/98	Bechtel 6/8-15/98	Tetra Tech 2 nd Baseline 9/8/98
PZ-01	Effluent System Well	NA	1100	NA	644
PZ-02	In fluent System Well	NA	1000	NA	1080
MW-45	Shallow Well	453	450	522	445
MW-46	Intermediate Well	829	890	1040	1030
MW-47	Deep Well	939	1100	1020	1140
MW-48	Shallow Well	756	800	835	905
MW-49	Deep Well	1010	1000	1040	1080
MW-50	Intermediate Well	983	1100	1010	993
MW-51	Intermediate Well	932	990	1000	1020
MW-52	Shallow Well	630	650	709	632
MW-53	Deep Well	1020	NA ⁽¹⁾	709	1115
MW-54	Fully Penetrating Well	NA	NA ⁽²⁾	NA	917

Notes:

mg/L Milligrams per liter

NA Not analyzed

⁽¹⁾ Monitoring well MW-53 was not sampled because of a malfunctioning bladder pump.

⁽²⁾ Monitoring well MW-54 was not sampled because of the presence of the multi-level diffusion sampler in the well.

TABLE A26

**METALS SUMMARY - MANGANESE
NoVOCs™ SITE Demonstration
Site 9, NAS North Island, California**

Well	Description	Manganese (mg/L)			
		Bechtel Baseline 2/6-12/98	Tetra Tech Baseline 4/17/98	Bechtel 6/8-15/98	Tetra Tech 2 nd Baseline 9/8/98
PZ-01	Effluent System Well	NA	1100	NA	369
PZ-02	Influent System Well	NA	1000	NA	843
MW-45	Shallow Well	750 E	450	822	733
MW-46	Intermediate Well	658 E	890	804	604
MW-47	Deep Well	981 E	1100	933	1030
MW-48	Shallow Well	1440 E	800	2420	2300
MW-49	Deep Well	444 E	1000	562	526
MW-50	Intermediate Well	977 E	1100	1180	1090
MW-51	Intermediate Well	1020 EN	990	1460	1310
MW-52	Shallow Well	377 E	650	485	492
MW-53	Deep Well	795 E	NA ⁽¹⁾	485	895
MW-54	Fully Penetrating Well	NA	NA ⁽²⁾	NA	989

Notes:

mg/L Milligrams per liter

NA Not analyzed

E Value estimated due to interference

EN Value estimated due to interference, and spiked sample recovery not within control limits

⁽¹⁾ Monitoring well MW-53 was not sampled because of a malfunctioning bladder pump.

⁽²⁾ Monitoring well MW-54 was not sampled because of the presence of the multi-level diffusion sampler in the well.

TABLE A27

METALS SUMMARY - MERCURY
NoVOCs™ SITE Demonstration
Site 9, NAS North Island, California

Well	Description	Mercury (Fg/L)			
		Bechtel Baseline 2/6-12/98	Tetra Tech Baseline 4/17/98	Bechtel 6/8-15/98	Tetra Tech 2 nd Baseline 9/8/98
PZ-01	Effluent System Well	NA	<0.20	NA	<0.20
PZ-02	Influent System Well	NA	<0.20	NA	<0.20
MW-45	Shallow Well	0.1 U	<0.20	0.1 U	<0.20
MW-46	Intermediate Well	0.1 U	<0.20	0.1 U	<0.20
MW-47	Deep Well	0.1 U	<0.20	0.1 U	<0.20
MW-48	Shallow Well	0.1 U	<0.20	0.1 U	<0.20
MW-49	Deep Well	0.1 U	<0.20	0.1 U	<0.20
MW-50	Intermediate Well	0.1 U	<0.20	0.1 U	<0.20
MW-51	Intermediate Well	0.1 U	<0.20	0.1 U	<0.20
MW-52	Shallow Well	0.1 U	<0.20	0.1 U	<0.20
MW-53	Deep Well	0.1 U	NA ⁽¹⁾	0.1 U	<0.20
MW-54	Fully Penetrating Well	NA	NA ⁽²⁾	NA	<0.20

Notes:

Fg/L Micrograms per liter

NA Not analyzed

< Less than

U Concentration below method detection limit (detection limit reported next to U)

⁽¹⁾ Monitoring well MW-53 was not sampled because of a malfunctioning bladder pump.

⁽²⁾ Monitoring well MW-54 was not sampled because of the presence of the multi-level diffusion sampler in the well.

TABLE A28

**METALS SUMMARY - NICKEL
NoVOCs™ SITE Demonstration
Site 9, NAS North Island, California**

Well	Description	Nickel (Fg/L)			
		Bechtel Baseline 2/6-12/98	Tetra Tech Baseline 4/17/98	Bechtel 6/8-15/98	Tetra Tech 2 nd Baseline 9/8/98
PZ-01	Effluent System Well	NA	<40	NA	<40
PZ-02	Influent System Well	NA	<40	NA	<40
MW-45	Shallow Well	14 UN	<40	8.3 U	<40
MW-46	Intermediate Well	14 UN	<40	8.3 U	<40
MW-47	Deep Well	14 UN	<40	8.3 U	<40
MW-48	Shallow Well	14 UN	<40	16.9 B	<40
MW-49	Deep Well	14 UN	<40	12.3 B	<40
MW-50	Intermediate Well	14 UN	<40	8.3 U	<40
MW-51	Intermediate Well	14 UN	<40	24.5 B	<40
MW-52	Shallow Well	14 UN	<40	8.3 U	<40
MW-53	Deep Well	14 UN	NA ⁽¹⁾	8.3 U	<40
MW-54	Fully Penetrating Well	NA	NA ⁽²⁾	NA	<40

Notes:

Fg/L Micrograms per liter

NA Not analyzed

< Less than

UN Concentration below method detection limit (detection limit reported next to UN), and spiked sample recovery not within control limits

U Concentration below method detection limit (detection limit reported next to U)

B Value is less than the instrument detection limit, but greater than or equal to the contract required detection limit

⁽¹⁾ Monitoring well MW-53 was not sampled because of a malfunctioning bladder pump.

⁽²⁾ Monitoring well MW-54 was not sampled because of the presence of the multi-level diffusion sampler in the well.

TABLE A29

METALS SUMMARY - POTASSIUM
NoVOCs™ SITE Demonstration
Site 9, NAS North Island, California

Well	Description	Potassium (mg/L)			
		Bechtel Baseline 2/6-12/98	Tetra Tech Baseline 4/17/98	Bechtel 6/8-15/98	Tetra Tech 2 nd Baseline 9/8/98
PZ-01	Effluent System Well	NA	410	NA	242
PZ-02	Influent System Well	NA	410	NA	307
MW-45	Shallow Well	189	210	194	174
MW-46	Intermediate Well	342	370	293	299
MW-47	Deep Well	361	420	344	340
MW-48	Shallow Well	235	290	248	260
MW-49	Deep Well	300	400	321	311
MW-50	Intermediate Well	328	460	333	317
MW-51	Intermediate Well	316	410	328	306
MW-52	Shallow Well	207	290	239	223
MW-53	Deep Well	299	NA ⁽¹⁾	239	333
MW-54	Fully Penetrating Well	NA	NA ⁽²⁾	NA	278

Notes:

mg/L Milligrams per liter

NA Not analyzed

⁽¹⁾ Monitoring well MW-53 was not sampled because of a malfunctioning bladder pump.

⁽²⁾ Monitoring well MW-54 was not sampled because of the presence of the multi-level diffusion sampler in the well.

TABLE A30

**METALS SUMMARY - SELENIUM
NoVOCs™ SITE Demonstration
Site 9, NAS North Island, California**

Well	Description	Selenium (Fg/L)			
		Bechtel Baseline 2/6-12/98	Tetra Tech Baseline 4/17/98	Bechtel 6/8-15/98	Tetra Tech 2 nd Baseline 9/8/98
PZ-01	Effluent System Well	NA	<50	NA	<100
PZ-02	Influent System Well	NA	<50	NA	<100
MW-45	Shallow Well	10 UN	<50	10 UWN	<100
MW-46	Intermediate Well	13 BWN	<50	25.8 +N	<100
MW-47	Deep Well	10 UWN	<50	20 UWN	<100
MW-48	Shallow Well	5 UW	<50	10 UWN	<100
MW-49	Deep Well	5 UW	<50	10 UW	<100
MW-50	Intermediate Well	5 UWN	<50	10 UWN	<100
MW-51	Intermediate Well	10 UWN	<50	10 UW	<100
MW-52	Shallow Well	5 UW	<50	17.7 BNS	<100
MW-53	Deep Well	5 UW	NA ⁽¹⁾	17.7 BNS	<100
MW-54	Fully Penetrating Well	NA	NA ⁽²⁾	NA	<100

Notes:

Fg/L Micrograms per liter

NA Not analyzed

< Less than

UN Concentration below method detection limit (detection limit reported next to UN), and spiked sample recovery not within control limits

UWN Concentration below method detection limit (detection limit reported next to UN), and spiked sample recovery and post digestion spike not within control limits

BWN Value is less than the instrument detection limit, but greater than or equal to the contract required detection limit, post digestion spike and spiked sample recovery not within control limits

BNS Value is less than the instrument detection limit, but greater than or equal to the contract required detection limit, spiked sample recovery not within control limits and reported value determined by Method of Standards additions

UW Concentration below method detection limit (detection limit reported next to UW) and post digestion sample out of control limits

(1) Monitoring well MW-53 was not sampled because of a malfunctioning bladder pump.

(2) Monitoring well MW-54 was not sampled because of the presence of the multi-level diffusion sampler in the well.

TABLE A31

METALS SUMMARY - SILVER
NoVOCs™ SITE Demonstration
Site 9, NAS North Island, California

Well	Description	Silver (Fg/L)			
		Bechtel Baseline 2/6-12/98	Tetra Tech Baseline 4/17/98	Bechtel 6/8-15/98	Tetra Tech 2 nd Baseline 9/8/98
PZ-01	Effluent System Well	NA	<10	NA	<10
PZ-02	Influent System Well	NA	<10	NA	<10
MW-45	Shallow Well	2.0 U	<10	1.9 U	<10
MW-46	Intermediate Well	2.0 U	<10	1.9 U	<10
MW-47	Deep Well	2.0 U	<10	1.9 U	<10
MW-48	Shallow Well	2.0 U	<10	1.9 U	<10
MW-49	Deep Well	2.0 U	<10	1.9 U	<10
MW-50	Intermediate Well	2.0 U	<10	1.9 U	<10
MW-51	Intermediate Well	2.0 U	<10	1.9 U	<10
MW-52	Shallow Well	2.0 U	<10	1.9 U	<10
MW-53	Deep Well	2.0 U	NA ⁽¹⁾	1.9 U	<10
MW-54	Fully Penetrating Well	NA	NA ⁽²⁾	NA	<10

Notes:

Fg/L Micrograms per liter

NA Not analyzed

< Less than

U Concentration below method detection limit (detection limit reported next to U)

⁽¹⁾ Monitoring well MW-53 was not sampled because of a malfunctioning bladder pump.

⁽²⁾ Monitoring well MW-54 was not sampled because of the presence of the multi-level diffusion sampler in the well.

TABLE A32

**METALS SUMMARY - SODIUM
NoVOCs™ SITE Demonstration
Site 9, NAS North Island, California**

Well	Description	Sodium (mg/L)			
		Bechtel Baseline 2/6-12/98	Tetra Tech Baseline 4/17/98	Bechtel 6/8-15/98	Tetra Tech 2 nd Baseline 9/8/98
PZ-01	Effluent System Well	NA	9700	NA	6480
PZ-02	Influent System Well	NA	9700	NA	8850
MW-45	Shallow Well	5550	5100	5970	4920
MW-46	Intermediate Well	8400	8000	9260	8030
MW-47	Deep Well	9890	9800	9430	9180
MW-48	Shallow Well	7410	7500	7930	7280
MW-49	Deep Well	8370	9200	9020	8420
MW-50	Intermediate Well	8570	9500	8900	7820
MW-51	Intermediate Well	8330	8800	8860	8250
MW-52	Shallow Well	6070	6700	6900	6220
MW-53	Deep Well	8870	NA ⁽¹⁾	6900	10300
MW-54	Fully Penetrating Well	NA	NA ⁽²⁾	NA	7850

Notes:

mg/L Milligrams per liter

NA Not analyzed

⁽¹⁾ Monitoring well MW-53 was not sampled because of a malfunctioning bladder pump.

⁽²⁾ Monitoring well MW-54 was not sampled because of the presence of the multi-level diffusion sampler in the well.

TABLE A33

**METALS SUMMARY - THALLIUM
NoVOCs™ SITE Demonstration
Site 9, NAS North Island, California**

Well	Description	Thallium (Fg/L)			
		Bechtel Baseline 2/6-12/98	Tetra Tech Baseline 4/17/98	Bechtel 6/8-15/98	Tetra Tech 2 nd Baseline 9/8/98
PZ-01	Effluent System Well	NA	<100	NA	<200
PZ-02	Influent System Well	NA	<100	NA	<200
MW-45	Shallow Well	5 UWN	<100	5 UWN	<200
MW-46	Intermediate Well	1 UWN	<100	5 UWN	<200
MW-47	Deep Well	5 UWN	<100	5 UWN	<200
MW-48	Shallow Well	5 UWN	<100	5 UWN	<200
MW-49	Deep Well	5 UWN	<100	5 UWN	<200
MW-50	Intermediate Well	8 BWN	<100	5 UWN	<200
MW-51	Intermediate Well	5 UWN	<100	5 UWN	<200
MW-52	Shallow Well	5 UWN	<100	5 UWN	<200
MW-53	Deep Well	5 UWN	NA ⁽¹⁾	5 UWN	<200
MW-54	Fully Penetrating Well	NA	NA ⁽²⁾	NA	<200

Notes:

Fg/L Micrograms per liter

NA Not analyzed

< Less than

BWN Value is less than the instrument detection limit, but greater than or equal to the contract required detection limit, post digestion spike and spiked sample recovery not within control limits

UWN Concentration below detection limit (detection limit reported next to UW), spiked sample recovery and post digestion spike not within control limits

⁽¹⁾ Monitoring well MW-53 was not sampled because of a malfunctioning bladder pump.

⁽²⁾ Monitoring well MW-54 was not sampled because of the presence of the multi-level diffusion sampler in the well.

TABLE A34

**METALS SUMMARY -VANADIUM
NoVOCs™ SITE Demonstration
Site 9, NAS North Island, California**

Well	Description	Vanadium (Fg/L)			
		Bechtel Baseline 2/6-12/98	Tetra Tech Baseline 4/17/98	Bechtel 6/8-15/98	Tetra Tech 2 nd Baseline 9/8/98
PZ-01	Effluent System Well	NA	<50	NA	133
PZ-02	Influent System Well	NA	<50	NA	163
MW-45	Shallow Well	12.0 B	<50	12.4 B	108
MW-46	Intermediate Well	14.1 B	<50	13.4 B	160
MW-47	Deep Well	14.7 B	<50	11.0 B	163
MW-48	Shallow Well	9.7 B	<50	10.8 B	149
MW-49	Deep Well	6.1 B	<50	14.1 B	164
MW-50	Intermediate Well	8.6 B	<50	11.2 B	156
MW-51	Intermediate Well	8.9 B	<50	13.1 B	161
MW-52	Shallow Well	7.4 B	<50	10.3 B	133
MW-53	Deep Well	5.8 B	NA ⁽¹⁾	10.3 B	162
MW-54	Fully Penetrating Well	NA	NA ⁽²⁾	NA	148

Notes:

Fg/L Micrograms per liter

NA Not analyzed

< Less than

B Value is less than the instrument detection limit, but greater than or equal to the contract required detection limit

⁽¹⁾ Monitoring well MW-53 was not sampled because of a malfunctioning bladder pump.

⁽²⁾ Monitoring well MW-54 was not sampled because of the presence of the multi-level diffusion sampler in the well.

TABLE A35

**METALS SUMMARY - ZINC
NoVOCs™ SITE Demonstration
Site 9, NAS North Island, California**

Well	Description	Zinc (Fg/L)			
		Bechtel Baseline 2/6-12/98	Tetra Tech Baseline 4/17/98	Bechtel 6/8-15/98	Tetra Tech 2 nd Baseline 9/8/98
PZ-01	Effluent System Well	NA	<20	NA	376
PZ-02	Influent System Well	NA	23	NA	1810
MW-45	Shallow Well	6.3 B	<20	2.8 B	127
MW-46	Intermediate Well	6.7 B	240	439	<20
MW-47	Deep Well	22.8	720	8.4 B	<20
MW-48	Shallow Well	10.6 B	58	11.9 B	<20
MW-49	Deep Well	47.1	100	42.4	29.4
MW-50	Intermediate Well	18.2 B	74	18.5 B	<20
MW-51	Intermediate Well	40.4	79	14.0 B	<20
MW-52	Shallow Well	15.0 B	<20	9.2 B	<20
MW-53	Deep Well	27.2	NA ⁽¹⁾	9.2 B	21.2
MW-54	Fully Penetrating Well	NA	NA ⁽²⁾	NA	<20

Notes:

Fg/L Micrograms per liter

NA Not analyzed

< Less than

B Value is less than the instrument detection limit, but greater than or equal to the contract reporting detection limit.

⁽¹⁾ Monitoring well MW-53 was not sampled because of a malfunctioning bladder pump.

⁽²⁾ Monitoring well MW-54 was not sampled because of the presence of the multi-level diffusion sampler in the well.

Table A36
GROUNDWATER VOC RESULTS ¾ MONITORING WELL (MW-54)
DIFFUSIONAL MULTI-LAYER SAMPLER
NoVOCsä SITE Demonstration
Site 9, NAS North Island, California

Sample Depth (feet bgs)	Units	ANALYTE				
		1,1- Dichloroethene	1,2-Dichloroethene	Trichloroethene	Tetrachloroethene	Vinly Chloride
44.8 ft	µg/L	8700D	6200D	280	ND	3600
46.0 ft	µg/L	7600D	6100D	650	ND	1800
48.0 ft	µg/L	4000	3700D	1600	ND	220
50.2 ft	µg/L	2600	1500	1600	ND	59
52.3 ft	µg/L	470	310	630	ND	55
54.2 ft	µg/L	200	180	290	ND	56
56.3 ft	µg/L	420	340	460	ND	27
58.4 ft	µg/L	1200D	690	780	ND	33
60.5 ft	µg/L	1600D	640	1300D	ND	53
62.6 ft	µg/L	620	420	1800D	3J	52
64.7 ft	µg/L	4300D	42000D	7600D	82	95
66.6 ft	µg/L	5800D	65000D	2800D	50J	110
68.6 ft	µg/L	7400D	76000D	2800D	50J	200
70.8 ft	µg/L	7500D	76000D	2800D	50J	260
72.8 ft	µg/L	7100D	76000D	2900D	52	300
75.0 ft	µg/L	8200D	78000D	3300D	52	320
77.0 ft	µg/L	7500D	74000D	1900D	50J	340
79.0 ft	µg/L	8000D	85000D	3500	40J	350

Notes:

- µg/L Microgram per Liter
- bgs Below ground surface
- D Laboratory qualifier identifies compounds in an analysis at a secondary dilution factor
- J Laboratory qualifier indicating the associated numerical value is an estimated quantity
- ND Not detected

NoVOCs™ Technology Evaluation Report

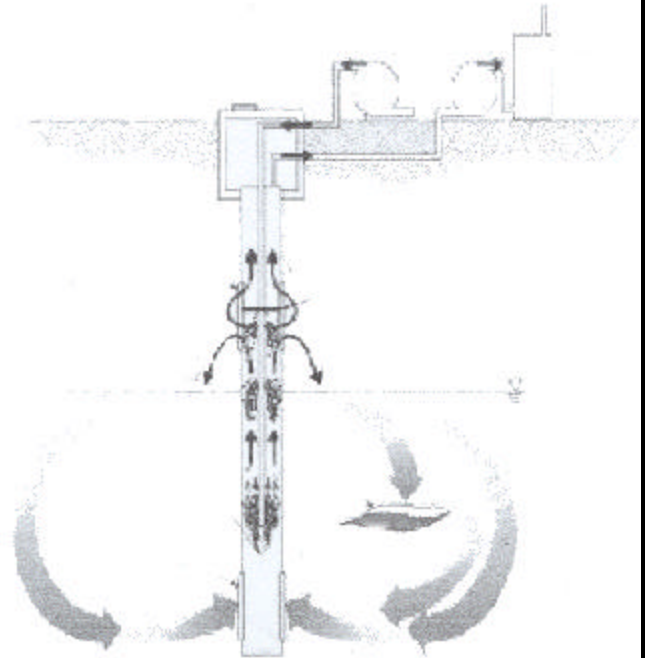

Appendix B Vendor Case Studies



NoVOCs™ INSTALLATION AT OCEANA NAVAL AIR STATION DCE CASE STUDY

Setting	Oceana NAS, Virginia Single well pilot NoVOCs installation
Hydrogeology	Fine sand with silt, hydraulic conductivity ~ 1x10 ⁻³ cm/sec Saturated thickness - 15 feet Hydraulic gradient - 0.007 ft/ft Vadose zone thickness - 3 to 5 ft.
Contamination	cis-1,2-DCE - peak concentrations as high as 10,000 ppb Lower levels of BTEX and TPH present Primary objective of hot-spot mass removal
Inorganic Chemistry	Dissolved iron - 80 ppm
Initial Results	Pumping rate - 5 gpm Period of operation - 3 month pilot operation Radius of influence greater than 40 feet, about 3 times plume thickness BTEX reduced to levels below or near detection limits Maximum 1,2-DCE concentration reduction - 99+ % Most wells within treatment zone have reached 1,2-DCE cleanup standard after 3 months of operation

1,2-DCE CONCENTRATION REDUCTIONS, 3 MONTHS OF OPERATION

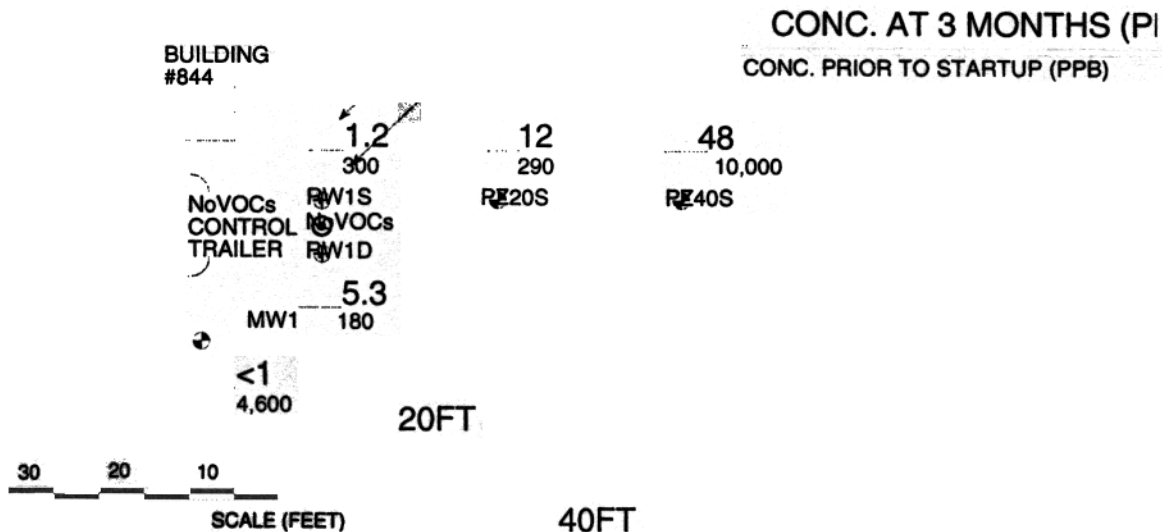

NoVOCs™ INSTALLATION AT OCEANA NAVAL AIR STATION

DCE CONCENTRATION REDUCTION PROFILES

(NOTE THE LOGARITHMIC SCALE ON THE Y-AXIS)

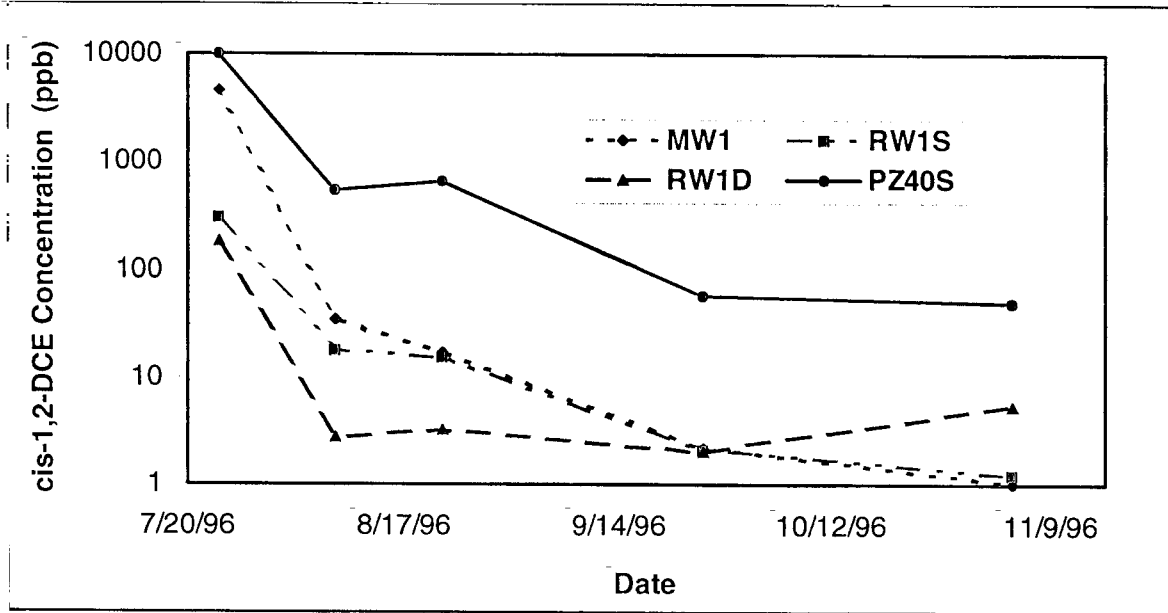

Operation Details

- 3 hp & 1.5 hp regenerative blowers
- Off - gas treatment - granular activated carbon
- pH control - automated acid metering system
- pH control system has effectively controlled iron precipitation/ fouling with virtually no maintenance
- Several monitoring wells to measure performance and radius of treatment zone
- At 5 gpm - air-to-water ratio = 75:1
- Mobile equipment trailer and process controls
- System operation has been in-service over 98% of time with very limited inspection (system shut-downs have been due to power outages and flooding from hurricanes)



**MACTEC Environmental
Technologies Company, L.L.C.**
A SUBSIDIARY OF MACTEC, Inc.

NoVOCs™ INSTALLATION AT A PIGMENT MANUFACTURING SITE

PCE CASE STUDY

Setting	Pigment manufacturing site, France Two-well commercial NoVOCs installation
Hydrogeology	Medium sand, hydraulic conductivity ~ 5×10^{-2} cm/sec Saturated thickness - 55 feet Hydraulic gradient - 0.007 ft/ft Vadose zone thickness - 8 ft.
Contamination	PCE - 3 ppm average initial dissolved concentration, peak concentrations as high as 23 ppm DNAPL presumed present Primary objective of hot-spot mass removal
Results	Pumping rate - 125 gpm NV-1, 60 gpm NV-2 Period of operation - 18 Months Radius of influence ~ 115 feet (35 meters) per well Maximum concentration reduction - 98% Average concentration reduction - 91% Total mass removal in conjunction with SVE ~ 4000 lbs of PCE

PCE CONCENTRATION REDUCTIONS AFTER 10 MONTHS OF OPERATION

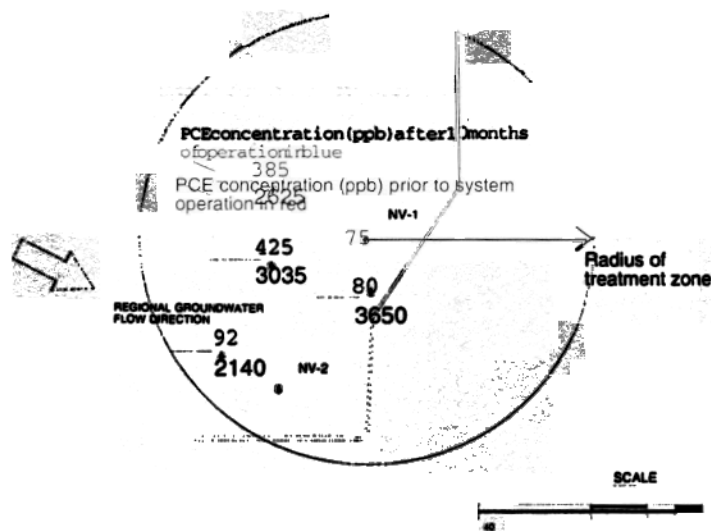

The predicted circulation zone for a NoVOCs well is an important system design parameter. The water recharged from the upper well screen in a NoVOCs well has dissolved oxygen (DO) concentrations in excess of the background DO found in most aquifers. Therefore, the distribution of DO in the aquifer can be used to demonstrate the extent of the area being treated by the NoVOCs well. At this site the circulation zone for each well was measured by analyzing DO in groundwater after 10 months of operation. The extent of the circulation zone for wells NV-1 and NV-2 is approximately 35 to 40 meters (115 to 130 feet) in radius, respectively. There was a reasonable match between the design-predicted and measured circulation zones.

Radial Influence of NoVOCs Well NV-1

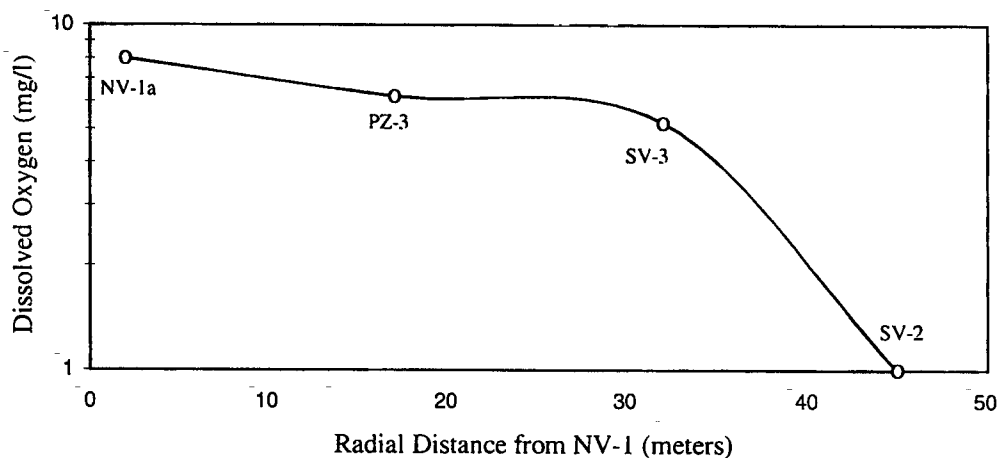

Radial Influence of NoVOCs Well NV-2

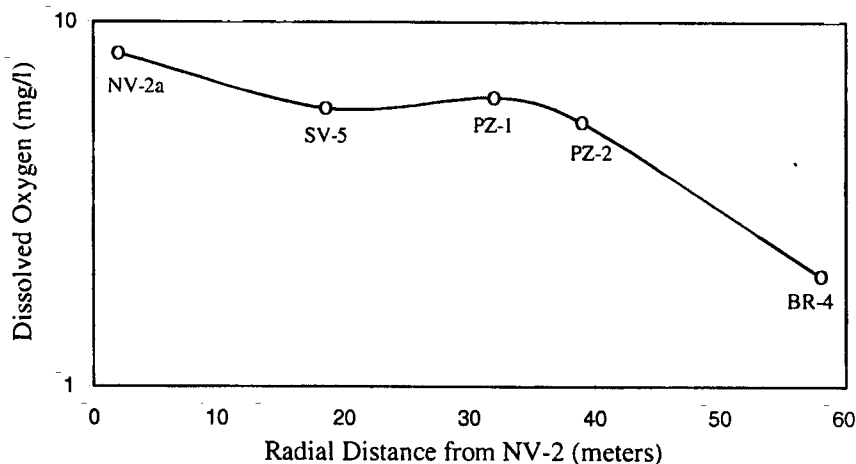

NoVOCs™ INSTALLATION AT INDUSTRIAL SITE, COEUR D'ALENE, IDAHO

Setting	Coeur d'Alene, Idaho Single well NoVOCs installation at light industrial plant TCE plume is present in the Rathdrum Prairie Aquifer, an EPA designated Sole Source Aquifer
Hydrogeology	Unconsolidated medium and coarse sands Hydraulic conductivity ~ 5×10^{-3} cm/sec Plume thickness - 30 feet. Vadose zone thickness - 190 ft.
Contamination	TCE - peak concentrations as high as 1,500 ppb Average concentrations of about 900 ppb Primary objective to treat plume under plant property (upgradient wells indicate upgradient TCE sources)
Inorganic Chemistry	Alkalinity of 247 mg/l as CaCO₃, groundwater is in equilibrium with calcite (indicating a strong potential for calcite scale formation)
Initial Results	Pumping rate - 35 gpm Period of operation - started in November 1996 Expected radius of treatment zone about 90 feet TCE concentration reduction of about 80% measured during the first 3 weeks of system operation Monitoring of inlet/outlet concentrations indicate 85% removal of TCE in a single pass through the NoVOCs well

Operation Details

- One 7.5 hp regenerative blower
- Closed loop system - no air discharge/permits
- Offgas treatment - granular activated carbon
- pH control - carbon dioxide addition
- pH control system has effectively controlled calcite precipitation/fouling with virtually no maintenance
- Three monitoring wells to measure performance/treatment zone
- At 35 gpm - air-water ratio = 14:1
- Mobile equipment trailer and process controls
- System operation has been in-service over 99% of time with very limited inspection

TCE CONCENTRATIONS OVER TIME AT COEUR D'ALENE, IDAHO

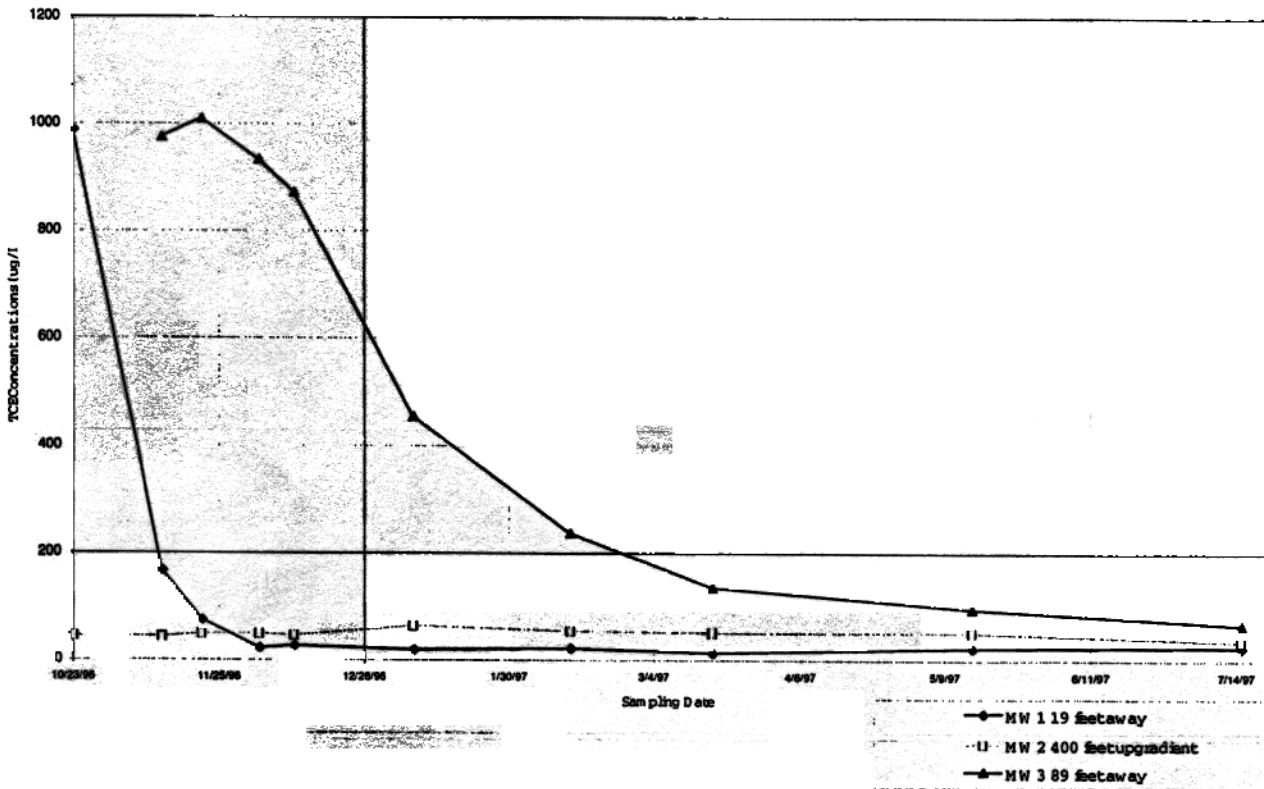

CASE STUDY

Project Name:	OTIS ANGB: ASHUMET VALLEY
Location:	Otis ANGB, Cape Cod, Massachusetts
Type of Site:	Residential
Start Date:	February 1997
Hydrogeologic Setting:	Scale of Plume: Four miles long, One-half mile wide, 30 -50 feet thick Darcian Velocity = 6.75×10^{-7} m/sec Soil Type/Texture: >95% Sand, <5% Silt Horizontal Conductivity (Kh) = 7.7×10^{-4} m/sec Vertical Conductivity (Kv) = 1.4×10^{-4} m/sec Horizontal hydraulic gradient = 0.00263 Thickness of treatment zone = 30 feet
Nature of Problem:	The source of contamination consisted mainly of chlorinated hydrocarbons (CHC) from a variety of suspected locations including leaching wells, oil interceptors, storm drain catch basins and drainage swales.
Project:	To design, install, test, operate and maintain a vertical circulation well system to evaluate the ability of such a system to reduce CHC concentrations in groundwater to 1 ppb and to prevent further migration of the plume.
Technology Applied:	Two UVB Labyrinth systems parallel to groundwater flow, effectively creating a contaminant treatment wall. A standard circulation cell was generated at each UVB location to cover the entire thickness of the plume and to create a treatment wall 115 feet wide.
Results:	In three months of operation, 80 % mass reduction in contaminant levels within cells. Upon startup, 100 % reduction in the levels of CHCs as measured in the effluent stream.
Benefits:	<ul style="list-style-type: none">• Effective treatment of 30 foot thick groundwater plume without groundwater extraction• Efficient stripping rates (97 to 99%)• Low energy and maintenance costs compared to conventional systems• Aesthetically pleasing shed construction, quiet operation• No adverse effects on groundwater such as drawdown or mounding• Clean water above plume unaffected
Point of Contact:	Warren Schultz MACTEC ET 410-798-8505



CASE STUDY

Project Name:	ACTIVE BUSINESS SCHOOL
Location:	White Plains, New York
Type of Site:	Commercial
Start Date:	June 1995
Hydrogeologic Setting:	Soil Type/Texture: >90% Sand, <10% Silt Horizontal Conductivity (Kh) = 1.0×10^{-5} m/sec Vertical Conductivity (Kv) = 1×10^{-6} m/sec Horizontal hydraulic gradient = 0.001 Thickness of treatment zone = 15 feet
Nature of Problem:	The source of contamination was a heating oil UST located beneath 5-story building.
Contaminants of Concern in Soil:	Highest level of total BTEX = 7,700 ppb. Range of clean-up guidance values for BTEX in soil = 14 ppb (benzene) to 100 ppb. Highest level of total targeted base neutral compounds = 46,250 ppb. Range of clean-up guidance values for base neutrals in soil = 200 ppb to 1,000 ppb.
Contaminants of Concern in Groundwater:	Highest level of total BTEX = 227 ppb. Range of clean-up guidance values for BTEX in groundwater = 0.7 ppb (benzene) to 5 ppb. Highest level of naphthalene = 89 ppb. Range of clean-up guidance values for base neutrals in groundwater = 10 ppb (naphthalene) to 50 ppb
Extent of Soil Contamination:	Areal/horizontal extent of "hot spot" area is approximately 20 feet by 20 feet. Vertical extent is approximately 10 feet.
Extent of Groundwater Contamination:	Areal/horizontal extent of plume is approximately 75 feet in length by 50 feet in width. Vertical extent of plume is approximately 15 feet below grade.
Project:	To design, install, test, operate and maintain a vertical circulation well system to evaluate the ability of such a system to reduce BTEX concentrations in groundwater to 50 ppb and to prevent further migration of the plume.
Technology Applied:	Two CGC units were installed to remediate soil and groundwater near source and downgradient of source, and a soil vapor extraction (SVE) system was installed to remediate soil and groundwater contamination at the source in "hot spot" area beneath floor of building basement.
Results:	BTEX - Concentrations of total BTEX have also decreased to below detectable levels in wells MW3 and MW5. Total BTEX concentrations have decrease in well MW2 from a baseline level of 277 ug/l to a current level of 23.1 ug/l. The only anomaly is monitoring well MW7 where total BTEX increased slightly in October 1996 from a baseline level of 73 ug/l to a level of 143 ug/l. Since that time total BTEX concentration in MW7 have decreased to 50.7 ug/l. SVOCs - Since July 1996 SVOCs are no longer present at the site. A No Further Action was issued in 1998..
Benefits:	<ul style="list-style-type: none">• Effective treatment of groundwater plume without groundwater extraction• Efficient stripping rates (97 to 99%)• Low energy and maintenance costs compared to comparable systems• Aesthetically pleasing shed construction, quiet operation• No adverse effects on groundwater such as drawdown or mounding
Point of Contact:	Warren Schultz MACTEC ET 410-798-8508



**MACTEC Environmental
Technologies Company, L.L.C.**
A SUBSIDIARY OF MACTEC, Inc.

CASE STUDY

- Project Name:** OTIS ANGB - CS-10 EAST
- Location:** Otis ANGB, Cape Cod, Massachusetts
- Type of Site:** Residential area
- Start Date:** December 1996
- Hydrogeologic Setting:** Scale of Plume: Three miles long, One mile wide, 120 feet thick
Darcian Velocity = .9 ft/day (3.15 x 10⁻⁶ m/sec)
Soil Type/Texture: >95% Sand, <5% Silt
Horizontal Conductivity (Kh) = 298 ft/day (.105 cm/sec)
Vertical Conductivity (Kv) = 60 ft/day (.021 cm/sec)
Horizontal hydraulic gradient = 0.003 ft/ft
Thickness of treatment zone = 120 feet (36.6 meters): two stacked circulation cells, 60 feet thick each cell
Flow Rate UVB (Q) = 60 GPM (13.6 m³/hr)
- Nature of Problem:** The source of contamination consisted mainly of chlorinated hydrocarbons (CHC) from a variety of suspected locations including leaching wells, oil interceptors, storm drain catch basins and drainage swales.
- Project:** To design, install, test, operate and maintain a vertical circulation well system to evaluate the ability of such a system to reduce CHC concentrations in groundwater from 3000 ppb to below MCLs (5 ppb) with a goal of 1 ppb as well as prevent further migration of the plume.
- Technology Applied:** Two UVB Labyrinth systems parallel to groundwater flow, effectively creating a contaminant treatment wall. Two vertical circulation cells (one standard and one reverse flow) were generated at each UVB location to treat the entire thickness of the plume and to create a treatment wall 90 feet wide.
- Results:** Achieved MCL (5 ppb) for TCE in 6 Months, and achieved 1 ppb. 100% chemical containment. Stripping efficiencies for TCE between 96-99%. Operational greater than 99%. No noticeable fouling, draw down or mounding. Predicted zones of capture, circulation and release were achieved.
- Benefits:**
- Effective treatment of 120 foot thick groundwater plume without groundwater extraction.
 - Efficient stripping rates
 - Low energy and maintenance costs compared to conventional systems
 - Aesthetically pleasing shed construction, quiet operation.
 - No adverse effects on groundwater such as draw down or mounding.
- Point of Contact:** Warren Schultz
MACTEC ET
410-798-8508



**MACTEC Environmental
Technologies Company, L.L.C.**
A SUBSIDIARY OF MACTEC, Inc.

UVB *IN SITU* TECHNOLOGY INSTALLATIONS

LOCATIONS	DATE INSTALLED	NUMBER OF SITES	NUMBER OF SYSTEMS	NUMBER OF CLOSURES
EUROPE	1986 - 1997	144	317	17
UNITED STATES	1991 - 1998	47*	69	2
TOTAL	12 YEARS	191	386	19



UVB AND CGC INSTALLATIONS IN THE UNITED STATES

JUNE 1998

PAGE 1/3

LOCATION	TYPE	CONTAMINANT	LITHOLOGY	HORIZONTAL HYDRAULIC CONDUCTIVITY cm/sec	TOTAL DEPTH feet	PLUME THICKNESS feet	CLIENT	DATE INSTALLED
ABERDEEN PROVING GROUNDS, MD	1 UVB LABYRINTH 1 UVB CANNISTER	PCA 1,1,2 TCE TEC 1,2 DCE	SILTY SAND AND CLAY	3.5×10^{-6}	25	20	RF WESTON US DoD (ARMY)	JUN 1988 NOV 1997
ASHEVILLE, NC	1 CGC	GASOLINE	SANDY SILT WITH CLAY	1.0×10^{-4}	37	10	CONFIDENTIAL	1994
BRUNSWICK, NJ	1 CGC	BENZENE	FINE TO COARSE SAND AND FINE GRAVEL	4.56×10^{-3}	20	10	MALCOLM PIRNIE (USACE)	1997
CHARLOTTE, NC	UVB 400 3-SCREEN SINGLE PUMP	CHC	SAPROLITE SILTY SAND WITH CLAY	1.8×10^{-3}	133.5	107.5	CONFIDENTIAL	JUL 1993
CHARLOTTE, NC	1-200 AIR LIFT	GASOLINE	SAPROLITE SILTY CLAYS TO SILTY SANDS	1.0×10^{-4}	30	22	CONFIDENTIAL	NOV 1994
CHESTER, SC	UVB 400 SINGLE PUMP	GASOLINE (BTEX)	SAPROLITE SILTY CLAY WITH SAND	1.0×10^{-4}	49	38	CONFIDENTIAL	SEPT 1994
CLEVELAND, NC	1-200 AIR LIFT	GASOLINE	SAPROLITE SILTY CLAY	1.0×10^{-4}	18	10-15	CONFIDENTIAL	1994
FAYETTEVILLE, NC	1-200 FIXED SINGLE PUMP	GASOLINE	SILTY CLAY	1.0×10^{-4}	55	20	CONFIDENTIAL	FEB 1995
FLORENCE, SC	1 UVB 200 w/ PUMP 1 UVB 400 w/2 PUMPS	BTEX	SILTY FINE SAND	9.9×10^{-4}	UVB 200-62 UVB 400-62	50	CONFIDENTIAL	1996
FREDERIC, WI	1 UVB 200 w/ PUMP	CHC	SILTY SAND WITH CLAY	1.0×10^{-4}	34	15	CONFIDENTIAL	1996
FRIDLEY, MN	1 UVB 200 w/ PUMP	CHC	FINE GRAINED ALLUVIUM	1.0×10^{-4}	72	53	CONFIDENTIAL	1995
GAINESVILLE, FL	UVB 400 BIOREACTOR w/ PUMP	CREOSOTE	FINE TO MEDIUM SAND	1.0×10^{-3}	25	17	US DoD(NAVY)	JAN 1995
GARDEN CITY, NY	1 UVB 400 w/ BIOREACTOR	BTEX PAH'S	FINE TO MEDIUM SAND	1.0×10^{-3}	40	30	RF WESTON(LILCO)	JUN 1998
GREENVILLE, SC	1 UVB 250 w/ PUMP	CHC	SANDY SILT WITH CLAY	1.0×10^{-4}	58.5	37	CONFIDENTIAL	1996
GROTON, CT	2 CGC	VOC	FINE TO MEDIUM SAND AND FINE GRAVEL	5.0×10^{-3}	10	5	CONFIDENTIAL	1996
HASTINGS, NB	1 UVB LABYRINTH	TCE	FINE TO MEDIUM SAND	1.0×10^{-4}	131	17	WOODWARD-CLYDE (USACE)	APR 1998
JACKSONVILLE, FL	2 UVB 250 FIXED	CHC	FINE TO MEDIUM SAND WITH SILT	3.24×10^{-4}	34.5	32	CONFIDENTIAL	1995
JACKSONVILLE, FL	2 UVB 250	CHC	MEDIUM/FINE SAND WITH CLAY LENSES	3×10^{-4}	30	25	CONFIDENTIAL	MAY 1996
JACKSONVILLE, NC	UVB 200	CHC	FINE SAND TO SILTY SAND WITH LENSES OF CLAY 12-16 Ft Bags	1.0×10^{-4}	UVB 72 CGC 13	4411.5	US DoD (MARINES)	1995
KALKASKA, MI	UVB 200 AIR LIFT	CHC	LAKE DEPOSITS MEDIUM TO FINE SAND	2.8×10^{-2}	60	28	CONFIDENTIAL	1994
KANNAPOLIS, NC	UVB 200 AIR LIFT	GASOLINE (BTEX)	SAPROLITE CLAYEY SILT WITH SAND	1.0×10^{-5}	52	38.3	CONFIDENTIAL	MAR 1993



MACTEC Environmental Technologies Company, L.L.C.
A SUBSIDIARY OF MACTEC, Inc.

UVB AND CGC INSTALLATIONS IN THE UNITED STATES

JUNE 1998

PAGE 2/3

LOCATION	TYPE	CONTAMINANT	LITHOLOGY	HORIZONTAL HYDRAULIC CONDUCTIVITY cm/sec	TOTAL DEPTH feet	PLUME THICKNESS feet	CLIENT	DATE INSTALLED
LAS VEGAS, NV	3 UVB 150	PETROLEUM	SANDY/SILTY CLAY	4.2×10^{-2}	30	20	CONFIDENTIAL	DEC 1996
LAUREL HILL, NC	UVB 400 SINGLE PUMP	GASOLINE (BTEX)	SAPROLITE CLAYEY SILT WITH SAND	1.0×10^{-4}	41	12.5	CONFIDENTIAL	SEP 1992
LINCOLNTON, NC	FIXED UVB 200 w/ PUMP	GASOLINE (BTEX)	SAPROLITE FINE TO MEDIUM SAND WITH SILT AND CLAY	8.8×10^{-5}	33.5	22	CONFIDENTIAL	AUG 1993
MADISON, WI	3 UVB 400 5 CGC	CHC BTEX	GLACIAL OUTWASH (GRAVELY SAND WITH SOME SILT)	5×10^{-3}	80	40	WI DNR	IN DESIGN
MEMPHIS, TN	UVB 250 SINGLE PUMP	CHC	FINE TO MED SAND TO SAND GRAVEL	8.0×10^{-2}	69	Confined Aquifer 34	CONFIDENTIAL	MAY 1995
NASHUA, NH	2 GZB	CREOSOT	VERY FINE TO MEDIUM SAND WITH SILTY ZONES	1×10^{-4}	44	20	CONFIDENTIAL	NOV 1996
NEW HOLLAND, PA	UVB 400	CHC	OVERBURDEN AND FRACTURED BEDROCK	1.1×10^{-3}	100	50	RF WESTON	JUN 1998
ORLANDO, FL	2 UVB CANNISTERS	TCE 1,2, DCE	FINE SANDS	1.0×10^{-3}	45	43	BECHTEL ENV US DoD (NAVY)	NOV 1997
OTIS AFB, MA CS-10 PLUME	2 UVB LABYRINTHS STACKED CELLS	CHC	MEDIUM TO COARSE SAND	UPPER: 2.8×10^{-2} LOWER: 5.5×10^{-2}	265	140	JACOBS ENG US DoD (AIR FORCE)	DEC 1996
OTIS AFB, MA ASHUMET VALLEY PLUME	2 UVB LABYRINTHS	CHC	FINE TO COARSE SAND	7.7×10^{-2}	109	31	JACOBS ENG US DoD (AIR FORCE)	FEB 1997
PANAMA CITY, FL	MODIF ED CGC RESEARCH	JET FUEL	MEDIUM SAND	1.0×10^{-3}	16.5	11.5	CONFIDENTIAL	1994
PELHAM, GA	2 REVERSE UVB 200 w/ PUMP	GASOLINE (BTEX)	MARINE DEPOSITS: SILTY FINE TO MEDIUM SAND	5.99×10^{-3}	20	15	CONFIDENTIAL	1992
PELHAM, NY	2 CGC	MTBE BTEX	FINE TO MEDIUM SAND AND GRAVEL	5.0×10^{-3}	17	10	MOBIL OIL	NOV 1996
PINE PLAINS, NY	1 CGC	BTEX	MEDIUM TO COARSE SAND, SOME GRAVEL	1.0×10^{-2}	16	9	PRIVATE GAS STATION	MAR 1996
PORT HUENEME, CA (North LA)	3 UVB 200 BIOCURTAIN AIR LIFT	GASOLINE	FINE TO MEDIUM SAND	1.0×10^{-3}	25	20	US DoD (NAVY)	DEC 1994
RALEIGH, NC	1 REVERSE FLOW	GASOLINE	FINE SANDY SILT WITH TRACE CLAY	9.6×10^{-4}	62	34	CONFIDENTIAL	1993
RICHLAND, WA	1 UVB 250	CARBON TETRACHLORIDE	FLUVIAL SANDS AND GRAVEL	4.23×10^{-3}	330	45	CONFIDENTIAL	1994
RIVERSIDE, CA	UVB 400 SINGLE W/ PUMP	CHC	ALLUVIAL FAN SILTY SAND	7.5×10^{-3}	81.7	40	US DoD (AIR FORCE)	MAY 1993



**MACTEC Environmental
Technologies Company, L.L.C.**
A SUBSIDIARY OF MACTEC, Inc.

UVB AND CGC INSTALLATIONS IN THE UNITED STATES

JUNE 1998
PAGE 3/3

LOCATION	TYPE	CONTAMINANT	LITHOLOGY	HORIZONTAL HYDRAULIC CONDUCTIVITY cm/sec	TOTAL DEPTH feet	PLUME THICKNESS feet	CLIENT	DATE INSTALLED
ROCHESTER, NY	UVB 400 BIOREACTOR w/ PUMP	CHC	GLACIAL TILL: SANDY SILT TO SILTY CLAY	5.0×10^{-3}	26	15	STATE OF NEW YORK	JUL 1994
ST. LOUIS PARK, MN	2 UVB 200 AIR LIFT	CHC	FLOOD PLAIN: SILT TO FINE TO MEDIUM SAND	6.9×10^{-3} 1.7×10^{-4}	30 50	18 37	CONFIDENTIAL	1994
SALT LAKE CITY, UT	1-200 FIXED SINGLE PUMP	CHC CHC	FINE TO MEDIUM GRAINED SAND	5.2×10^{-3}	133	26	US DoD (AIR FORCE)	SEP 1994
SAN FRANCISCO, CA	UVB 400 AIR LIFT	GASOLINE (BTEX)	COASTAL PLAIN FINE TO MEDIUM SAND	5.3×10^{-2}	39	33	US DoD (ARMY)	AUG 1994
SHELBY, NC	1 CGC/BLK	PCE	SILT WITH CLAY	1.0×10^{-4}	24	10	CONFIDENTIAL	1993
TAMPA, FL	2 CGC	BTEX	SILTY/CLAYEY SAND	2×10^{-5}	30	23	FDEP	NOV 1996
TROUTMAN, NC	UVB 400 AIR LIFT	GASOLINE (BTEX)	SAPROLITE CLAYEY SILT WITH SAND	1.9×10^{-4}	66.5	20	CONFIDENTIAL	SEP 1992
VERO BEACH, FL	1 UVB LABYRINTH 1 UVB COMPACT STRIPPER	TCE	SAND AND SHELL ZONES	1.0×10^{-2}	75	65	PIPER AIRCRAFT	JAN 1998
WATERTOWN, NY	UVB 400 SINGLE PUMP	BTEX	FINE TO MEDIUM SAND WITH SOME GRAVEL	4.7×10^{-3}	27	20	RF WESTON US DoD (ARMY)	JUNE 1995
WEAVERVILLE, NC	1 CGC/BLK	GASOLINE	SAND SILT WITH CLAY	6×10^{-4}	40	8	CONFIDENTIAL	1991
WHITE PLAINS, NY	2 CGC COUPLED WITH SVE	BTEX SVOCs	FINE TO MEDIUM SAND LITTLE SILT AND GRAVEL (TILL)	2.7×10^{-4}	20	10	PRIVATE BUSINESS SCHOOL	JUN 1995
WILMINGTON, CA	2 UVB 200 AIR LIFT	GASOLINE (BTEX)	COASTAL PLAIN FINE SILTY SAND	2.0×10^{-3}	79 70	34 35	CONFIDENTIAL	1993
WILMINGTON, NC	FIXED UVB 200 w/ PUMP	GASOLINE (BTEX)	COASTAL PLAIN FINE TO MEDIUM SAND	1.0×10^{-3}	20	15	CONFIDENTIAL	JUN 199
WINSTON SALEM, NC	FIXED UVB 200 w/ PUMP	JET FUEL	SAPROLITE	1.0×10^{-4}	41	20	CONFIDENTIAL	1993
YONKERS, NY	2 UVB AIR LIFT w/ PUMP	BTEX	FINE SAND TO SAND AND COBBLES	8.8×10^{-3}	25-30'	-5	WESTCHESTER COUNTY	JUN 1996 JUN 1995



MACTEC Environmental Technologies Company, L.L.C.
A SUBSIDIARY OF MACTEC, Inc.

GERMAN UVB CLOSURE SITES
MAY 1996
PAGE 1/2

NO.	SITE AND MAJOR CONTAMINANT	BEGINNING CONC. [ppb] DATE	CLOSURE CONC. [ppb] DATE	POST CLOSURE CONC. DATE [ppb]	IEG SYSTEM	AQUIFER TYPE K/[cm/s] AND THICKNESS [m]	TOTAL REMEDIATION TIME [YRS]
1	Berlin I CHC	3,100 4/89	30 7/90	<30 3/92	UVB 400 AIR LIFT	Unconsolidated 10 ⁻³ 6	1.3
2	Schelklingen CHC	1,800 1/90	10 7/92	5 1/93	UVB 400 AIR LIFT	KARST 6	1.5
3	Ebersbach CHC	15,000 10/89	4 5/93	20 8/93	UVB 400 AIR LIFT	Unconsolidated 10 ⁻⁴ 3	2.5
4	Berlin II BTEX + CHC	280,000 BTEX 10/90	<50 2/93	<50 6/93	2 UVBs 400 w/PUMP (REV. FLOW)	Unconsolidated 10 ⁻³ 11	2.3
5	Berlin III BTEX + CHC	10/91	<75 4/93	<50 7/93	6 UVBs 400 w/ PUMP	Unconsolidated 10 ⁻³ 12	2.4
6	Berlin IV BTEX + CHC	39,000 5/93	<25 10/94	<25 3/95	2 UVBs 400 w/ PUMP (REV. FLOW)	Unconsolidated 10 ⁻³ 35 (2 aquifers)	1.7
7	Plochingen CHC	4,000 5/89	<10 12/93	<10 5/94	UVB 300 w/ PUMP	Unconsolidated 10 ⁻⁴ 8	3.5
8	Frankfurt CHC	2,000 2/89	20 2/91	<20 5/91	UVB 400 w/ PUMP	Unconsolidated 10 ⁻⁴ 12.5	2.0
9	Mainz CHC	800 6/91	<20 6/94	<20 9/94	UVB 400 AIR LIFT	Unconsolidated 10 ⁻⁴ 15	3
10	Forth CHC	3,800 8/89	10 1/91	<10 12/95	UVB 400 AIR LIFT	Unconsolidated 10 ⁻⁴ 3	1
11	Parchim KW + BTEX	790 KW 7/93 2,690 BTEX	KW:ND 11/94 BTEX:ND	<5 4/95	2 GZB/SZB 400 w/ 2 PUMPS	Unconsolidated 10 ⁻⁵ 10	1.4



**MACTEC Environmental
Technologies Company, L.L.C.**
 A SUBSIDIARY OF MACTEC, Inc.

GERMAN UVB CLOSURE SITES

MAY 1996

PAGE 2/2

NO.	SITE AND MAJOR CONTAMINANT	BEGINNING CONC. [ppb] DATE	CLOSURE CONC. [ppb] DATE	POST CLOSURE CONC. DATE [ppb]	IEG SYSTEM	A QUIFER TYPE K/[cm/s] AND THICKNESS [m]	TOTAL REMEDIATION TIME [YRS]
12	Tuebingen CHC	50 12/86	5 1/90	<5 1/91	UVB 400 AIR LIFT	Unconsolidated 10 ⁻⁴ 10	3.0
13	Eislingen CHC	10,000 3/89	<10 5/92	<25 5/92	UVB 400 AIR LIFT	Unconsolidated 10 ⁻⁴ 7	3.1
14	Genger CHC	2,000 8/87	<10 2/90	<25 7/92	UVB 250 AIR LIFT	Unconsolidated 10 ⁻⁴ 8	2.6
15	Berlin V CHC	10,000 12/88	<25 11/94	<25 4/95	2 UVBs 400 w/ PUMP	Unconsolidated 10 ⁻³ 11	5.9
16	Eisenhuettenstadt	5,860 10/92 soil samples only!	66 8/93	<25	GZB/UVB 400 w/ PUMP	Unconsolidated 10 ⁻² 10	1.2
17	Cologne CHC	2,100 5/92	<10 3.95	<10 12/95	2 UVB 400 w/ PUMP	Unconsolidated 10 ⁻² 18	4

- Standard flow if not otherwise stated

- 400 = 400mm diameter casing
- 300 = 300mm diameter casing
- 250 = 250mm diameter casing
- CHC = chlorinated hydrocarbons
- BTEX = Benzene, Toluene, Ethylbenzene, Xylene
- KW = Hydrocarbons

- UVB = Vacuum Vaporizer Well
- GZB = Groundwater Circulation Well
- SZB = Flushing Circulation Well



**MACTEC Environmental
Technologies Company, L.L.C.**
A SUBSIDIARY OF MACTEC, Inc.

NoVOCs™ Technology Evaluation Report

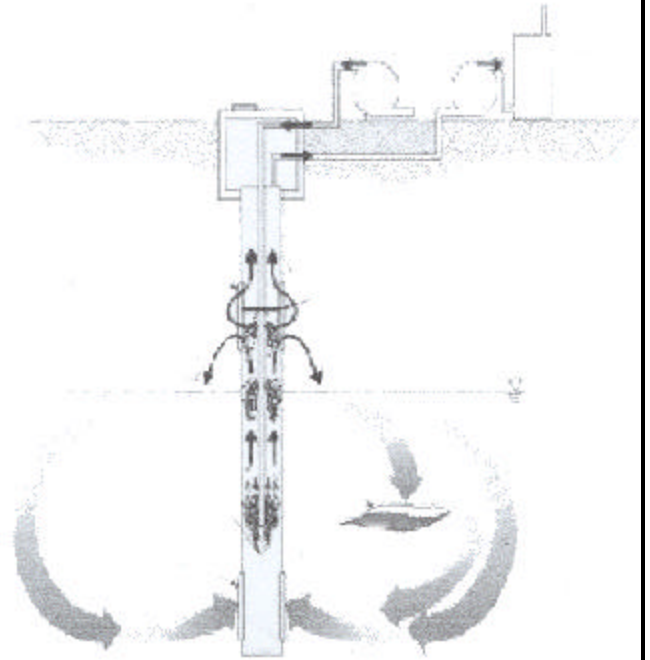

Appendix C Hydrogeological Report



**HYDROGEOLOGICAL INVESTIGATION OF THE
AQUIFER TREATED BY THE NoVOCs™ SYSTEM**

**NAVAL AIR STATION NORTH ISLAND
SAN DIEGO, CALIFORNIA**

Prepared For

**U.S. Environmental Protection Agency
National Risk Management Research Laboratory
Superfund Innovative Technology Evaluation Program
Cincinnati, Ohio**

Prepared by

**Tetra Tech EM Inc.
San Diego, California**

August 3, 2000

TABLE OF CONTENTS

<u>Section</u>	<u>Page</u>
EXECUTIVE SUMMARY	ES-1
1.0 INTRODUCTION	1-1
1.1 SITE PROGRAM.....	1-2
1.2 PROJECT OBJECTIVES	1-2
2.0 BACKGROUND.....	2-1
2.1 THE NoVOCs™SYSTEM.....	2-1
2.1.1 General Description.....	2-1
2.1.2 NoVOCs™Monitoring System at NAS North Island.....	2-2
2.2 SITE HISTORY	2-2
2.3 SITE TOPOGRAPHY	2-4
2.4 REGIONAL AND SITE GEOLOGY	2-4
2.4.1 Regional Geology	2-4
2.4.2 Site Geology	2-4
2.5 SITE HYDROGEOLOGY.....	2-5
2.6 SOIL AND GROUNDWATER CONTAMINATION.....	2-6
3.0 TIDAL INFLUENCE STUDY.....	3-1
3.1 CONFIGURATION AND PROCEDURES.....	3-1
3.2 RESULTS	3-2
3.2.1 Tidal Influence	3-2
3.2.2 NoVOCs™System Influence.....	3-3
4.0 AQUIFER TESTING.....	4-1
4.1 PRETESTING ACTIVITIES	4-1
4.1.1 NoVOCs™Equipment Removal.....	4-2
4.1.2 Video Survey and Well Screen Development.....	4-2
4.1.3 Aquifer Test Equipment Installation and Configuration	4-3
4.1.4 Data Logger Programming	4-5
4.2 STEP DRAWDOWN TEST OF THE UPPER SCREENED INTERVAL	4-6
4.2.1 Procedures	4-6
4.2.2 Results.....	4-6
4.3 CONSTANT DISCHARGE PUMPING TEST OF THE UPPER SCREENED INTERVAL.....	4-7
4.3.1 Procedures	4-7
4.3.2 Results.....	4-8

TABLE OF CONTENTS (continued)

4.4	INJECTION TEST OF THE UPPER SCREENED INTERVAL.....	4-8
4.4.1	Procedures	4-8
4.4.2	Results.....	4-9
4.5	STEP DRAWDOWN TEST OF THE LOWER SCREENED INTERVAL.....	4-9
4.5.1	Procedures	4-10
4.5.2	Results.....	4-10
4.6	DIPOLE FLOW TEST	4-10
4.6.1	Configuration and Procedures.....	4-11
4.6.2	Results.....	4-11
4.7	WATER QUALITY PARAMETERS.....	4-12
5.0	DATA INTERPRETATION.....	5-1
5.1	TIDAL INFLUENCE CORRECTION.....	5-1
5.1.1	Relationship Between Tide and Groundwater Fluctuation.....	5-1
5.1.2	Procedure for Calculating Tidal Efficiency and Time Lag	5-3
5.1.3	Calculation of Tidal Efficiency and Time Lag Using April 1998 Tidal Study Data.....	5-5
5.1.4	Procedures for Tidal Correction of Groundwater Drawdown Data.....	5-6
5.1.5	Tidal Influence Correction for the Constant Pumping Test.....	5-13
5.2	CALCULATION OF SPECIFIC CAPACITY AND WELL EFFICIENCY.....	5-14
5.2.1	Specific Capacity Calculation	5-14
5.2.2	Well Loss and Well Efficiency	5-15
5.3	AQUIFER HYDRAULIC PARAMETER CALCULATION.....	5-19
5.3.1	Site Hydrogeologic Conceptual Model.....	5-20
5.3.2	Constant Discharge Pumping Test Configuration	5-21
5.3.3	Drawdown Response Characteristics.....	5-21
5.3.4	Selection of Analytical Model	5-23
5.3.5	Results and Discussion.....	5-24
5.4	DETERMINATION OF GROUNDWATER FLOW PATTERNS.....	5-25
5.4.1	Mean Groundwater Level Calculation from Tidally Influence Water Levels	5-26
5.4.2	Density Correction of Groundwater Levels.....	5-27
5.4.3	Corrected Water Levels and Horizontal Groundwater Flow Direction	5-31
5.4.4	Vertical Hydraulic Gradient Correction	5-33
5.5	DIPOLE FLOW TEST	5-37
5.5.1	Mathematical Models.....	5-37
5.5.2	Modified Dipole Flow Test Solution for Wellbore Storage	5-39
5.5.3	Dipole Flow Test Data Interpretation and Aquifer Anisotropy Estimation	5-41
6.0	CONCLUSIONS.....	6-1
7.0	REFERENCES.....	7-1

APPENDICES

Appendix

- A LOG OF BORING S9-SB-34(BECHTEL 1998)
- B HYDROGRAPHS (TIDAL STUDY)
- C HYDROGRAPHS (STEP DRAWDOWN TEST UPPER SCREEN INTERVAL)
- D HYDROGRAPHS (CONSTANT DISCHARGE PUMPING TEST)
UPPER SCREEN INTERVAL)
- E HYDROGRAPHS (INJECTION TEST UPPER SCREEN INTERVAL)
- F HYDROGRAPHS (STEP DRAWDOWN TEST LOWER SCREEN INTERVAL)
- G GRAPHS (DIPOLE TEST)
- H DATA LOGGER AND PRESSURE TRANSDUCER SPECIFICATIONS

FIGURES

(All figures follow the text of each section.)

Figure

- 1-1 VICINITY MAP
- 1-2 NAS NORTH ISLAND AND SITE 9 LOCATION MAP
- 1-3 SITE 9 CHEMICAL WASTE DISPOSAL AREA
- 2-1 NoVOCs™SYSTEM
- 2-2 WELL LOCATIONS
- 2-3 GENERALIZED CROSS-SECTION
- 2-4 SITE 9 TOPOGRAPHIC ELEVATIONS
- 2-5 GEOLOGIC CROSS-SECTION LOCATION
- 2-6 GEOLOGIC CROSS-SECTION A – A'
- 4-1 STEP DRAWDOWN TEST-UPPER SCREENED INTERVAL PUMPING WELL CONFIGURATION
- 4-2 CONSTANT DISCHARGE PUMPING TEST-UPPER SCREENED INTERVAL PUMPING WELL CONFIGURATION
- 4-3 INJECTION TEST-UPPER SCREENED INTERVAL INJECTION WELL CONFIGURATION
- 4-4 STEP DRAWDOWN TEST-LOWER SCREENED INTERVAL PUMPING WELL CONFIGURATION
- 4-5 DIPOLE FLOW TEST WELL CONFIGURATION
- 5-1 WATER LEVEL COMPARISON BETWEEN SAN DIEGO BAY AND OBSERVATION WELL MW45
- 5-2 OBSERVED GROUNDWATER ELEVATION AND BEST-FIT TIDAL INFLUENCE CURVE FOR WELL MW20
- 5-3 OBSERVED WATER LEVEL COMPARISON AMONG BAY TIDE, MW20 AND MW45
- 5-4 OBSERVED WATER LEVEL COMPARISON AMONG BAY TIDE, MW20 AND MW46
- 5-5 OBSERVED WATER LEVEL COMPARISON AMONG BAY TIDE, MW20 AND MW47
- 5-6 OBSERVED WATER LEVEL COMPARISON AMONG BAY TIDE, MW20 AND MW48
- 5-7 OBSERVED WATER LEVEL COMPARISON AMONG BAY TIDE, MW20 AND MW49
- 5-8 OBSERVED WATER LEVEL COMPARISON AMONG BAY TIDE, MW20 AND MW52
- 5-9 OBSERVED WATER LEVEL COMPARISON AMONG BAY TIDE, MW20 AND MW53
- 5-10 OBSERVED WATER LEVEL COMPARISON AMONG BAY TIDE, MW20 AND MW54
- 5-11 OBSERVED AND SIMULATED WATER LEVEL COMPARISON AMONG BAY TIDE, MW20, MW45 DURING THE PUMPING TEST
- 5-12 OBSERVED AND CORRECTED GROUNDWATER DRAWDOWN AT WELL MW45
- 5-13 OBSERVED AND CORRECTED GROUNDWATER DRAWDOWN AT WELL MW46
- 5-14 OBSERVED AND CORRECTED GROUNDWATER DRAWDOWN AT WELL MW47
- 5-15 OBSERVED AND CORRECTED GROUNDWATER DRAWDOWN AT WELL MW48
- 5-16 OBSERVED AND CORRECTED GROUNDWATER DRAWDOWN AT WELL MW49
- 5-17 OBSERVED AND CORRECTED GROUNDWATER DRAWDOWN AT WELL MW52
- 5-18 OBSERVED AND CORRECTED GROUNDWATER DRAWDOWN AT WELL MW53
- 5-19 OBSERVED AND CORRECTED GROUNDWATER DRAWDOWN AT WELL MW54
- 5-20 s/Q vs. Q PLOTS
- 5-21 s/Q vs. Q PLOTS
- 5-22 MAXIMUM DRAWDOWN VS. PUMPING RATE AND THE BEST FIT EQUATION
- 5-23 MAXIMUM WATER LEVEL RISE VS. RECHARGE RATE AND THE BEST FIT EQUATION
- 5-24 MAXIMUM DRAWDOWN VS. PUMPING RATE AND THE BEST FIT EQUATION
- 5-25 MW45 DRAWDOWN DATA PLOT AND TYPE CURVE MATCH

FIGURES (continued)

- 5-26 MW46 DRAWDOWN DATA PLOT AND TYPE CURVE MATCH
- 5-27 MW47 DRAWDOWN DATA PLOT AND TYPE CURVE MATCH
- 5-28 MW48 DRAWDOWN DATA PLOT AND TYPE CURVE MATCH
- 5-29 MW49 DRAWDOWN DATA PLOT AND TYPE CURVE MATCH
- 5-30 MW52 DRAWDOWN DATA PLOT AND TYPE CURVE MATCH
- 5-31 MW53 DRAWDOWN DATA PLOT AND TYPE CURVE MATCH
- 5-32 MW54 DRAWDOWN DATA PLOT AND TYPE CURVE MATCH
- 5-33 THE MEAN EQUIVALENT FRESH WATER HEAD CONTOUR AND HORIZONTAL
GROUNDWATER FLOW DIRECTION (UPPER AQUIFER ZONE, FOUR DATA POINTS,
AUGUST 1998)
- 5-34 THE MEAN EQUIVALENT FRESH WATER HEAD CONTOUR AND HORIZONTAL
GROUNDWATER FLOW DIRECTION (UPPER AQUIFER ZONE, THREE DATA POINTS,
AUGUST 1998)
- 5-35 THE MEAN EQUIVALENT FRESH WATER HEAD CONTOUR AND HORIZONTAL
GROUNDWATER FLOW DIRECTION (LOWER AQUIFER ZONE, THREE DATA POINTS,
AUGUST 1998)

TABLES

(All tables follow the text and figures of each section.)

Table

2-1	WELL SCREEN INTERVALS
3-1	START AND STOP TIMES FOR THE NoVOCs™ SYSTEM
4-1	TEST EXECUTION SUMMARY, STEP DRAWDOWN TEST – UPPER SCREEN INTERVAL
4-2	TEST EXECUTION SUMMARY, CONSTANT DISCHARGE PUMPING TEST – UPPER SCREEN INTERVAL
4-3	TEST EXECUTION SUMMARY, INJECTION TEST – UPPER SCREEN INTERVAL
4-4	TEST EXECUTION SUMMARY, STEP DRAWDOWN TEST – LOWER SCREEN INTERVAL
4-5	TEST EXECUTION SUMMARY, DIPOLE FLOW TEST
4-6	WATER QUALITY PARAMETERS, AQUIFER PUMPING TESTS
5-1	TIDAL INFLUENCE PARAMETER VALUES, TIDAL INFLUENCE STUDY OF APRIL 10 THROUGH 20, 1998
5-2	PARAMETERS USED IN TIDAL CORRECTION FOR THE CONSTANT DISCHARGE PUMPING TEST
5-3	AQUIFER TEST DATA AND THE NoVOCs™ WELL SPECIFIC CAPACITY
5-4	AQUIFER TEST DATA AND WELL EFFICIENCY
5-5	UPPER AQUIFER ZONE, CONSTANT DISCHARGE PUMPING TEST CONFIGURATION
5-6	CONSTANT DISCHARGE PUMPING TEST INFORMATION
5-7	AQUIFER HYDRAULIC PARAMETERS, UPPER AQUIFER CONSTANT DISCHARGE PUMPING TEST
5-8	MEAN GROUNDWATER AND EQUIVALENT FRESH-WATER HEADS

ACRONYMS AND ABBREVIATIONS

bgs	Below ground surface
cm/sec	Centimeters per second
CPT	Cone penetrometer test
DCA	Dichloroethane
DCE	Dichloroethene
DFT	Dipole flow test
DNAPL	Dense nonaqueous phase liquid
Eh	Reduction/oxidation potential
EPA	U. S. Environmental Protection Agency
ft/day	Feet per day
ft/ft	Feet per foot
ft ² /day	Square feet per day
gpm	Gallons per minute
gpm/ft	Gallons per minute per foot
g/cm ³	Grams per cubic centimeter
IR	Installation Restoration
MACTEC	MACTEC Inc.
mg/kg	Milligrams per kilogram
mg/L	Milligrams per liter
MLLW	Mean lower low water
mv	Millivolts
NAS	Naval Air Station
NOAA	National Oceanic and Atmospheric Administration
NTU	Nephelometric turbidity units
ORD	Office of Research and Development
OSWER	Office of Solid Waste and Emergency Response
PAH	Polynuclear aromatic hydrocarbon
PCE	Tetrachloroethene
psi	Pounds per square inch
PVC	Polyvinyl chloride
scfm	Standard cubic feet per minute
SITE	Superfund Innovative Technology Evaluation
SVOC	Semivolatile organic compound
1,1-TCA	1,1-Trichloroethane
TDS	Total Dissolved Solids
TCE	Trichloroethene

ACRONYMS AND ABBREVIATIONS (continued)

Tetra Tech	Tetra Tech EM Inc.
VOC	Volatile organic compound
Fmhos/cm	Micromhos per centimeter

EXECUTIVE SUMMARY

In support of the U.S. Environmental Protection Agency (EPA) Superfund Innovative Technology Evaluation (SITE) Program, Tetra Tech EM Inc. (Tetra Tech) is evaluating the MACTEC Inc. (MACTEC) NoVOCs™ in-well volatile organic compound (VOC) stripping system at Installation Restoration (IR) Site 9 at Naval Air Station (NAS) North Island in San Diego, California. The NoVOCs™ system is a patented recirculating well that is designed for the in situ remediation of groundwater contaminated by VOCs.

In April 1998, the Navy initiated operation of the NoVOCs™ system. By June 1998, the pumping rate had been reduced from the design rate of 25 gallons per minute (gpm) to approximately 5 gpm because not all water pumped at higher rates could be injected into the aquifer. The NoVOCs™ system was shut down on June 19, 1998, to evaluate the cause of the problem. Suspected causes for the poor injection performance included (1) biofouling or scaling of the screen intervals and formation near the NoVOCs™ system, (2) design problems with the NoVOCs™ well, in particular the sizing of the recharge screen, and (3) possible differences in hydraulic characteristics between the upper and lower portions of the aquifer.

EPA directed Tetra Tech to conduct the hydrogeological study at the demonstration site to provide information on the recharge capacity of the NoVOCs™ system and the hydraulic characteristics of the aquifer in the vicinity of the NoVOCs™ system. The groundwater study included: (1) a tidal influence study to evaluate natural variations in water level at the site due to tides in San Diego Bay, and (2) a series of groundwater pumping tests in the shallow and deep portions of the aquifer, including step drawdown tests, a 32-hour constant pumping rate test, an injection test, and a dipole flow test to evaluate the aquifer characteristics in the vicinity of the NoVOCs™ system.

The hydrogeological investigation of the aquifer treated by the NoVOCs™ system has yielded valuable information regarding the hydraulic characteristics of the aquifer, pumping and injection capacities of the NoVOCs™ well, and defects in the NoVOCs™ well. The conclusions of the investigation are as follows:

- 1) The tested aquifer is in good hydraulic communication with San Diego Bay. Groundwater levels at different depths within the aquifer are all influenced by tidal fluctuations in San Diego Bay. The tidal influence of the aquifer is demonstrated by the drawdown data collected from the observation wells during the constant discharge pumping test of the NoVOCs™ well.

- 2) The groundwater levels must be corrected for tidal effects to allow the calculation of aquifer parameters and mean groundwater elevations. In addition, the mean groundwater elevations must be corrected for density effects to allow determination of groundwater flow patterns. After tidal and density corrections, the mean equivalent fresh water head contour maps were generated.
- 3) The aquifer hydraulic tests show that the upper and lower aquifer zones are in good hydraulic communication. Drawdown responses were observed in both aquifer zones during the constant discharge pumping test in the upper aquifer zone and the step-drawdown tests in the upper and lower aquifer zones.
- 4) Groundwater generally flows to the west or northwest in both of the upper and lower aquifer zones. The horizontal hydraulic gradient in both aquifer zones is relatively flat, ranging from 0.005 to 0.01.
- 5) Two methods were developed for tidal correction of groundwater drawdown data obtained during the constant discharge pumping test. The methods involve using the tidal influence study data collected in April 1998 to calculate the tidal efficiency and time lag for each of the observation wells. The estimated tidal efficiency ranges from 0.05 to 0.1 in different tidal cycles at different wells; and time lags range from 46 to 96 minutes.
- 6) Observed drawdown data collected during the constant discharge pumping test were corrected using the two new tidal correction methods. The corrected drawdown (that is, drawdown data with the tidal effects removed) using both methods correlates well with each other and reflects typical pumping test responses. The corrected drawdown matches reasonably well with Neuman type curves for the aquifer parameter estimation.
- 7) The aquifer hydraulic parameters were estimated based on the tidally corrected groundwater drawdown data for the constant discharge pumping test. The average hydraulic conductivity was estimated as 29 feet per day (ft/day) or 0.01 centimeters per second (cm/sec). The average aquifer storativity and specific yield are 0.004 and 0.07, respectively. The average ratio of horizontal to vertical hydraulic conductivity is estimated at 5.7.
- 8) Specific capacity and efficiency of the NoVOCsTM well were estimated based on the step-drawdown tests and water injection test conducted at the NoVOCsTM well. The calculated average specific capacities are 1.48 gallons per minute per foot (gpm/ft) for the upper screened interval during pumping, 1.50 gpm/ft during injection, and 3.22 gpm/ft for the lower screened interval during pumping. The calculated average well efficiencies are 82 percent for the upper screened interval during pumping, 97 percent during injection, and 91 percent for the lower screened interval during pumping. The 97-percent well efficiency for the upper screened injection is for injection of clean tap water.
- 9) The radius of influence, as defined as the distance from the pumping well to an observation well at which drawdown can be positively identified (0.01 feet), was at least 100 feet during the constant discharge pumping test with a pumping rate of 20 gallons per minute (gpm).
- 10) No positive (recharge) or negative (flow barrier) boundaries are evident from the constant discharge pumping test data.

- 11)** The injection test results show that the maximum flow of clean tap water that can be injected through the upper screen of the NoVOCs™ well is 25 gpm. At that injection rate, the water level will rise 17 feet and reach the ground surface.
- 12)** The video survey of the NoVOCs™ well revealed a manufacturing defect in the upper well screen. The screen slots are unevenly cut, and about 30 percent of the slots do not completely penetrate the PVC casing. This defect affects the well efficiency of the upper screened interval and may reduce the available water level rise in the NoVOCs™ well during recharge to the aquifer through the upper screen.
- 13)** The video survey also revealed significant fouling of the NoVOCs™ well screens by iron precipitation and microbiological growth. Such fouling may impair the performance of the NoVOCs™ system by obstructing the well screen and filter pack.
- 14)** The findings of the aquifer tests and tidal study of the aquifer treated by the NoVOCs™ system indicate that the aquifer hydraulic conditions are suitable for application of the NoVOCs™ technology. The NoVOCs™ well as designed should be able to extract and inject a flow rate of 20 gpm based on the aquifer hydraulic characteristics.

1.0 INTRODUCTION

In support of the U.S. Environmental Protection Agency (EPA) Superfund Innovative Technology Evaluation (SITE) Program, Tetra Tech EM Inc. (Tetra Tech) is evaluating the MACTEC Inc. (MACTEC) NoVOCsTM in-well volatile organic compound (VOC) stripping system at Installation Restoration (IR) Site 9 at Naval Air Station (NAS) North Island in San Diego, California. The NoVOCsTM system is a patented recirculating well that is designed for the in situ remediation of groundwater contaminated by VOCs. A vicinity map, site location map, and site plan are presented as Figures 1-1, 1-2, and 1-3.

In April 1998, the Navy initiated operation of the NoVOCsTM system. The EPA SITE Program evaluation of the NoVOCsTM system also began in April 1998, and included collection of air and groundwater samples from the NoVOCsTM system and surrounding monitoring points. The evaluation was conducted in accordance with the draft final "Technology Evaluation Plan/Quality Assurance Project Plan for the MACTEC NoVOCsTM Technology Evaluation at NAS North Island" (Tetra Tech 1998). By June 1998, the pumping rate had been reduced from the design rate of 25 gallons per minute (gpm) to approximately 5 gpm because not all water pumped at higher rates could be injected into the aquifer. Based on discussions between the Navy and the technology developer, the system was shut down on June 19, 1998, to evaluate the cause of the poor injection performance. Suspected causes for the poor injection performance included (1) biofouling or scaling of the screen intervals and formation near the NoVOCsTM system, (2) design problems with the NoVOCsTM well, in particular the sizing of the recharge screen, and (3) possible differences in hydraulic characteristic between the upper and lower portions of the aquifer. This report presents the results of a hydrogeological investigation to assess the hydraulic characteristics of the aquifer that may affect the NoVOCsTM system performance.

EPA directed Tetra Tech to conduct the hydrogeological study at the demonstration site to obtain information on the recharge capacity of the NoVOCsTM system and the aquifer hydraulic characteristics in the vicinity of the NoVOCsTM system. The hydrogeological study included: (1) a tidal influence study to evaluate natural variations in water level at the site due to tides in San Diego Bay, and (2) a series of aquifer hydraulic tests in the shallow and deep portions of the aquifer, including step drawdown tests, a 32-hour constant discharge pumping test, an injection test, and a dipole flow test to evaluate the aquifer characteristics in the vicinity of the NoVOCsTM system.

This report presents background information on the NoVOCs™ system and IR Site 9, documents the field methods and procedures implemented during the groundwater study, presents the study results, discusses the data analysis and interpretation, and presents conclusions based on the information obtained. The remainder of this section presents information on the EPA SITE program and the hydrogeological study objectives.

1.1 SITE PROGRAM

SITE was established by EPA's Office of Solid Waste and Emergency Response (OSWER) and Office of Research and Development (ORD) in response to the Superfund Amendments and Reauthorization Act of 1986. The SITE program was established to accelerate the development, evaluation, and use of innovative technologies to remediate hazardous waste sites. The evaluation portion of the SITE program focuses on technologies in the pilot- or full-scale development stage. The evaluations are intended to collect performance data of known quality. In support of this portion of the program, a series of aquifer tests were conducted to assist in evaluating the NoVOCs™ system by providing a greater understanding of the site hydrogeology.

1.2 PROJECT OBJECTIVES

The overall objective of the groundwater study was to assess hydraulic characteristics of the aquifer in the vicinity of the NoVOCs™ system at the demonstration site. In support of this objective, the specific objectives of the groundwater study were to: (1) document groundwater elevation change (water level) in selected wells due to tidal influence, and (2) conduct a series of aquifer hydraulic tests to assess hydrogeologic conditions in the vicinity of the NoVOCs™ system.

Aquifer hydraulic tests of the NoVOCs™ well (IW-01) were conducted to estimate or assess the following:

- Well efficiencies of the two screened intervals of the NoVOCs™ well: the outer casing is screened at 43 to 47 feet below ground surface (bgs) (-21.3 to -25.3 feet relative to mean lower low water [MLLW]) and 72 to 78 feet bgs (-50.3 to -56.3 feet MLLW).
- Hydraulic parameters of the upper and lower portions of the aquifer, including estimation of hydraulic conductivity, transmissivity, storativity, and aquifer anisotropy.
- The radius of influence established during pumping.

- The presence of hydraulic barriers that may affect hydraulic communication between the upper and lower zones of the aquifer.

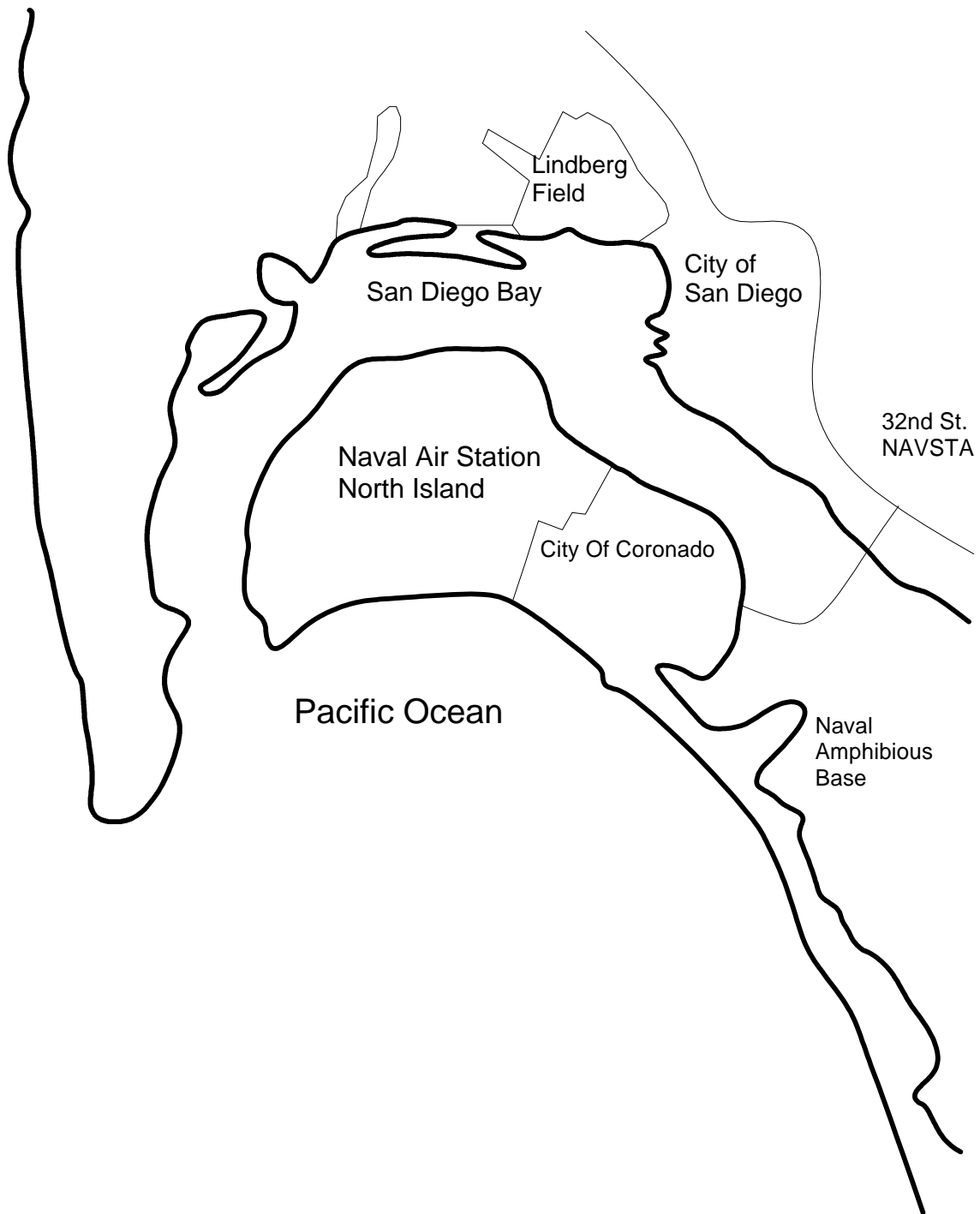

NAS NORTH ISLAND SITE 9
NoVOCs™ TECHNOLOGY EVALUATION

**FIGURE 1-1
VICINITY MAP**

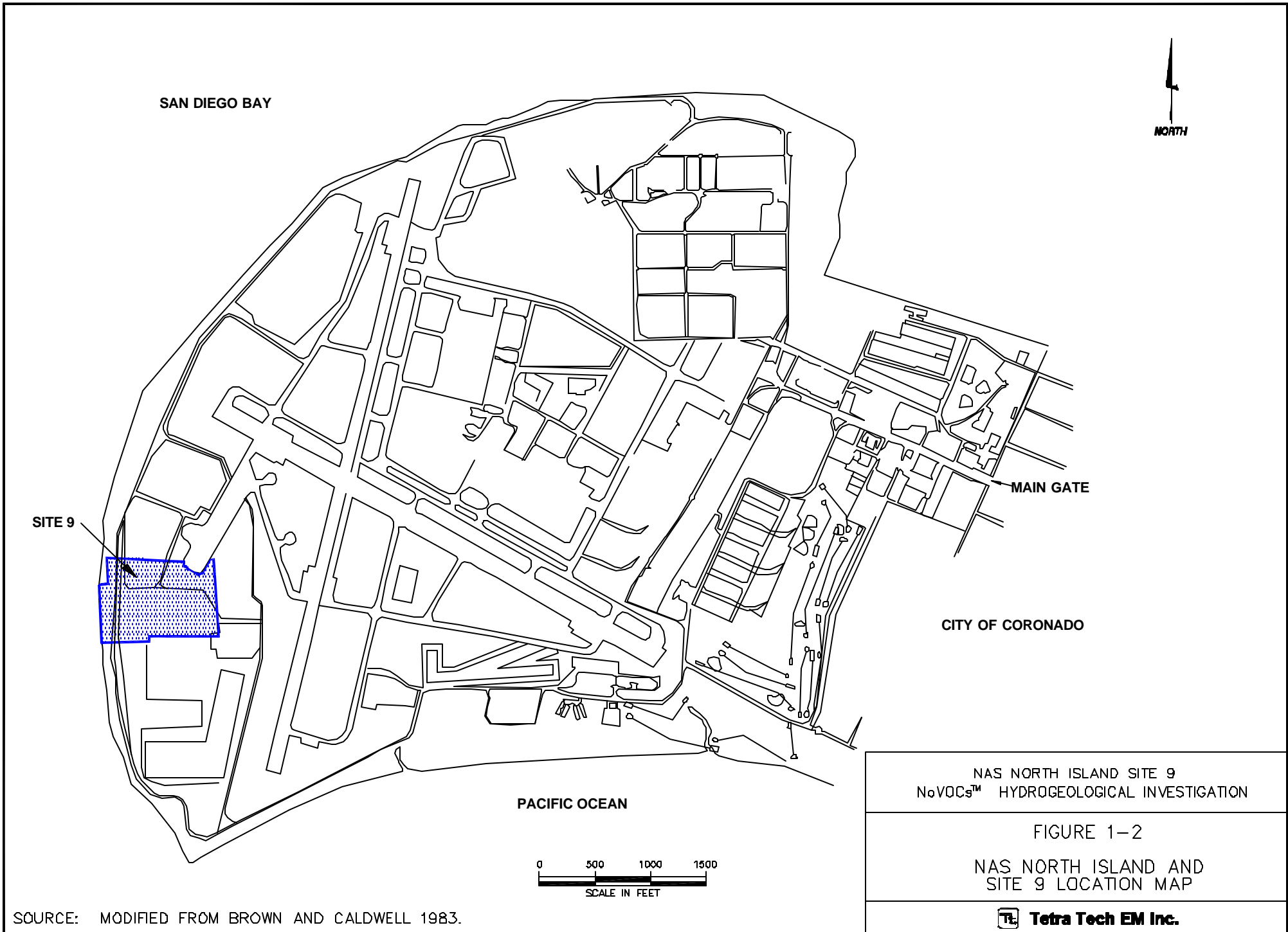

SAN DIEGO BAY



MAIN GATE

SITE 9

CITY OF CORONADO

PACIFIC OCEAN

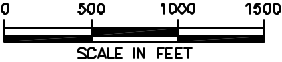

NAS NORTH ISLAND SITE 9
NoVOCs™ HYDROGEOLOGICAL INVESTIGATION

FIGURE 1-2





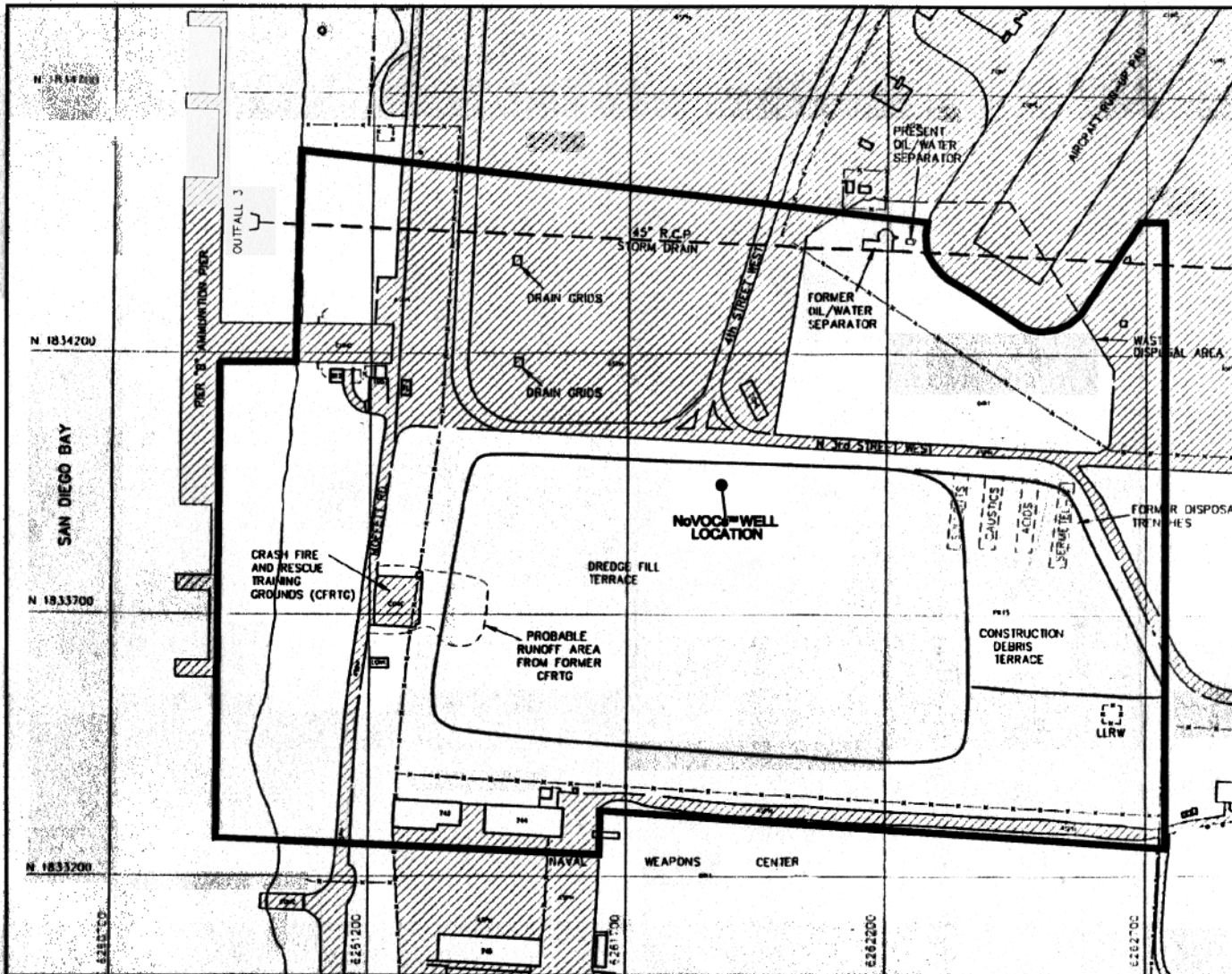

NAS NORTH ISLAND AND
SITE 9 LOCATION MAP



SOURCE: MODIFIED FROM BROWN AND CALDWELL 1983.

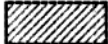

LEGEND

-  FENCE
-  ROAD AND STREET
-  BUILDING
-  PAVEMENT (CONCRETE OR ASPHALT)
-  TERRACE BORDERS
-  LLRW
-  STORM DRAIN
-  SITE 9 BOUNDARY

NOTES:

1. BASE MAP ADAPTED FROM PHOTGRAMMETRY BY BECHTEL NATIONAL, INC., 1984.
2. ELEVATION DATUM IS MEAN LOWER LOW WATER.
3. COORDINATES ARE IN THE CALIFORNIA COORDINATE SYSTEM (1983) ZONE 6 BASED ON THE NORTH AMERICAN DATUM (1983).



NAS NORTH ISLAND SITE 9
 NoVOCS™ HYDROGEOLOGICAL INVESTIGATION

FIGURE 1-3
 SITE 9 CHEMICAL WASTE DISPOSAL AREAS

2.0 BACKGROUND

This section describes the NoVOCs™ system and the associated groundwater monitoring system at NAS North Island. This section also provides information on site conditions, including site history, topography, geology, hydrogeology, and soil and groundwater contamination. In addition, this section identifies the locations and describes the construction of wells installed to investigate the hydrogeology of the site.

2.1 THE NoVOCs™ SYSTEM

This section provides a general description of the NoVOCs™ system at NAS North Island and describes the groundwater monitoring system for evaluating the NoVOCs™ system performance.

2.1.1 General Description

The NoVOCs™ system is a patented in-well stripping process (U.S. Patent No. 5,180,503) for in situ removal of VOCs from groundwater. A diagram of the treatment process is shown in Figure 2-1. In this process, air injected into a specially designed well simultaneously creates an air-lift pump and an in situ stripping reactor to circulate and remediate groundwater (EG&GE 1996).

The NoVOCs™ system consists of a well casing installed in the contaminated saturated zone, with two screened intervals below the water table and an air injection line extending into the groundwater within the well. Contaminated groundwater enters the well through the lower screen and is pumped upward within the well by pressurized air supplied through the air injection line, creating an air-lift pump effect. As the water is air-lifted within the well, dissolved VOCs in the water volatilize into the rising air bubbles and are transported to the upper portion of the well. The treated water rises to a deflector plate and is forced out the upper screen. The treated water is recharged to the aquifer, and the stripped VOC vapors are removed from the subsurface by a vacuum applied to the upper well casing (EG&GE 1996). The stripped vapors then are treated by the Thermatrix flameless oxidation process. The equipment used to operate the NoVOCs™ system, including blowers, control panel, and air temperature, pressure, and flow rate gauges is housed in an on-site control trailer.

2.1.2 NoVOCs™ Monitoring System at NAS North Island

At NAS North Island, one NoVOCs™ well has been installed to remediate a portion of the aquifer downgradient of a contaminant source area. Assuming the designed pumping rate of 25 to 30 gpm and a total air flow rate of 120 standard cubic feet per minute (scfm), the radius of influence of the NoVOCs™ well for this site is predicted to be at least 90 feet (EG&GE 1997). To evaluate the accuracy of this prediction and to obtain information on the horizontal and vertical extent of the NoVOCs™ treatment cell and assess changes in contaminant concentrations within the treatment cell, two ½-inch outer diameter piezometers (PZ-01 and PZ-02) and 10 2-inch outer diameter groundwater observation wells (MW-45 through MW-54) were installed.

Figure 2-2 shows a plan view of the location of the NoVOCs™ well and observation wells. Figure 2-3 shows a generalized cross-section of the NoVOCs™ well, piezometers, and observation wells. The two piezometers were installed within the sand pack of the NoVOCs™ well: one adjacent to the NoVOCs™ recharge screen (PZ-01), and one adjacent to the NoVOCs™ intake screen (PZ-02). The natural groundwater flow direction across the site is generally to the west. Seven cross-gradient observation wells were installed at four distances from the NoVOCs™ well, as follows: a cluster of three wells 30 feet from the NoVOCs™ well (observation wells MW-45, MW-46, and MW-47), a well pair 60 feet from the NoVOCs™ well (observation wells MW-48 and MW-49), and single observation wells 90 and 105 feet from the NoVOCs™ well (observation wells MW-50 and MW-51). Two downgradient observation wells (MW-52 and MW-53) were installed as a pair approximately 100 feet from the NoVOCs™ well, and a single observation well (MW-54) was also installed 100 feet upgradient of the NoVOCs™ well. Each observation well was screened at one of the following three intervals: at the top of the treatment zone (between approximately 41 and 47 feet bgs [-19.1 to -25.0 feet MLLW]), in the middle of the treatment zone (between approximately 49 and 62 feet bgs [-35.1 to -40.4 feet MLLW]), and at the bottom of the treatment zone (between approximately 67 and 78 feet bgs [-43.6 to -58.0 feet MLLW]). A summary of well screen intervals for the individual wells is presented in Table 2-1.

2.2 SITE HISTORY

NAS North Island is the largest naval aviation complex on the West Coast and is home to two aircraft carriers and the Third Fleet flagship, USS Coronado. NAS North Island is located at the northern end of the peninsula that forms San Diego Bay and is bordered by the City of Coronado to the east, the Pacific Ocean to the south, and San Diego Bay to the north and west (Figure 1-1). The 2,806-acre complex,

officially commissioned in 1917, provides aviation support services to the fleet, aircraft maintenance, airfield operations, pierside services, and logistics. The mission of NAS North Island is to maintain and operate facilities and to provide services and materiel that support operation of aviation activities and units of the Operating Forces of the Navy, as well as other units as designated by the Chief of Naval Operations.

Past hazardous waste disposal practices at NAS North Island have resulted in soil and groundwater contamination. The Navy has undertaken investigations to determine the extent of contamination and possible cleanup methods as part of the IR Program. Under the IR Program, 14 contaminated areas have been designated IR sites, one of which is Site 9 (Figure 1-2).

Site 9, the 40-acre former chemical waste disposal area, is located on the western end of NAS North Island. Site 9 operated from the 1940s to the mid-1970s and consisted of three major waste disposal areas: a shallow pit used for disposal of liquid wastes (located within the waste disposal area shown in Figure 1-3); four parallel trenches each containing different types of wastes (solvents, caustics, acids, and semisynthetics consisting of ceramic and metallic compounds); and a large unimproved area used for burying drums containing unidentified chemical wastes located south of the NoVOCs™ well. An estimated 32 million gallons of waste were disposed of at Site 9 over its 30 years of operation (Jacobs 1995a).

Contamination from these disposal areas has migrated to the underlying groundwater. Although there is no official history of chemical disposal for most of Site 9 outside of the three disposal areas, groundwater contamination is widespread throughout the site. Elevated levels of chlorinated solvents and their breakdown products, as well as petroleum hydrocarbons and metals, are present in groundwater at Site 9. Based on the high dissolved concentrations of chlorinated solvent compounds, the presence of dense nonaqueous phase liquids (DNAPL) in the subsurface is suspected.

The Navy selected a location immediately south of the intersection of 4th Street West and North 3rd Street West to install the NoVOCs™ system (Figure 1-3). Cone penetrometer test (CPT) boreholes advanced at the proposed NoVOCs™ location provided additional characterization of subsurface lithology and confirmed that significant groundwater contamination was present (Bechtel 1998).

2.3 SITE TOPOGRAPHY

The topography of the northern half of Site 9 is relatively flat with an elevation of approximately 13 feet above MLLW. It has virtually no relief and is covered by asphalt paving. The southern half of the site is unpaved, and is almost entirely covered by a terrace composed of hydraulic dredge spoils. The terrace has an elevation of approximately 23 feet above MLLW along its north face and slopes gently southward to approximately 18 feet above MLLW (Jacobs 1994). Topographic elevations and surface features are shown in Figure 2-4. The NoVOCs™ well is located on the terrace at a surface elevation of approximately 22 to 23 feet above MLLW.

2.4 REGIONAL AND SITE GEOLOGY

This section discusses the regional and site geology for Site 9.

2.4.1 Regional Geology

NAS North Island is situated in the coastal portion of the Peninsular Range Geologic Province. This region is underlain by a basement complex of late Cretaceous undifferentiated igneous rocks of the Southern California Batholith and Jurassic prebatholithic metavolcanic rocks. The basement complex is nonconformably overlain by a sedimentary succession of marine and nonmarine rocks that were deposited within the San Diego embayment. These rocks range in age from Late Cretaceous to Recent. The most abundant deposits of the embayment are gently folded and faulted Eocene marine, lagoonal, and nonmarine rocks that thin eastward and trend northwest.

2.4.2 Site Geology

Site 9 is underlain by artificial fill to a depth of approximately 15 feet bgs in the vicinity of the NoVOCs™ well. The artificial fill in this area varies in thickness. The terrace is composed of hydraulic fill derived from dredging the San Diego Bay and consists of fine-grained, loose sand. In addition, in the immediate vicinity of the site, the former Whaler's Bight, a shallow lagoon formerly present at the western edge of North Island, was filled with sediments during the early part of the twentieth century. Below the fill material is the Bay Point Formation, a poorly consolidated, fine- and medium-grained fossiliferous sandstone (Kennedy 1975).

The depositional environment of the site was lagoonal and shallow marine. Sediment accumulated on the southern portion of North Island generally from northward transport of sediment along the shore. As described below, most of the uppermost sediments at the site are composed of fine-grained sand, with varying amounts of silt and medium-grained sand. Two thin silt and clay layers are present in the subsurface at the site and are likely to be continuous in the vicinity of the site, based on observations in the numerous borings and wells installed at the site (Bechtel 1998).

The first fine-grained layer is a thin (2 to 5 feet thick) clay, silt, and clayey sand layer designated as “A clay/silt” (Jacobs 1994). A clay/silt occurs at approximately 35 to 40 feet bgs and is present beneath Site 9 (Jacobs 1994). Recent investigations by Bechtel have indicated that the A clay/silt is continuous from the proposed NoVOCs™ well locations west to the shoreline wells. Beneath the unconsolidated sediments is a sandstone layer at approximately 90 feet bgs. The second layer is the B clay, located approximately 105 feet bgs that also appears to be continuous in the vicinity of the site. The location of a geologic cross-section is shown in Figure 2-5, and the cross-section depicting the subsurface geology of the site is shown in Figure 2-6.

Boring S9-SB-34 located near the NoVOCs™ well encountered mostly sand and silty sand. The A clay/silt was encountered at 35.5 feet bgs, dense sands were encountered between 60 and 61 feet bgs and 65 to 67.5 feet bgs, and a thin cemented sandstone layer was encountered at 79 feet bgs. In addition, the sand fractions of the sands and silty sands ranged from very fine- to coarse-grained and contained various quantities of shell fragments. The log for boring S9-SB-34 is provided in Appendix A.

2.5 SITE HYDROGEOLOGY

The generally accepted hydrogeologic model for islands and peninsulas surrounded by salt water is a lens-shaped body of fresh water resting isostatically atop salt water because of density differences. At Site 9, groundwater occurs at approximately 8 feet bgs (5 feet above MLLW). The upper 110 feet of the saturated zone contains an unconfined aquifer with a thin (5 to 20 feet), discontinuous fresh water lens, a brackish mixing zone (30 to 100 feet), and a seawater wedge intruding inland. Values for some of the hydrogeological parameters of the site are as follows (Jacobs 1995b):

- Hydraulic Gradient: 0.0008 foot per foot (ft/ft) over most of the site, but steepens near the shoreline to 0.006 ft/ft
- Transmissivity: 1,195 square feet per day (ft²/day)

- Specific yield: 3.2×10^{-1} (dimensionless)
- Hydraulic Conductivity: 12 feet per day (ft/day) or 4.2×10^{-3} centimeters per second (cm/sec)
- Effective Porosity: 0.25 (dimensionless)

In general, the hydraulic gradient is toward the west, varying between southwest and northwest. The groundwater is tidally influenced.

The distribution of groundwater contamination suggests that the general flow of groundwater is toward the west. Contaminants associated with the site have been detected in pore water of San Diego Bay, west of Site 9 (SPARWAR Systems Center 1998). A survey of pore water concentrations of VOCs was conducted in the spring of 1998 in the upper 5 feet of sediment adjacent to and west of Site 9. The results of the survey documented that VOCs were present in the pore water at depths of approximately 20 to 30 feet below MLLW. The data suggest that contaminants are migrating west from Site 9, at a depth consistent with the A clay/silt layer, and discharging to the bay through pore water interchange with the bay water (Bechtel 1998).

2.6 SOIL AND GROUNDWATER CONTAMINATION

Based on findings from previous investigations at the site (Jacobs 1995a,b), high concentrations of chlorinated solvents, chlorinated solvent breakdown products, petroleum hydrocarbons, and metals are present in the saturated and unsaturated zones. The major contaminants detected in groundwater are chlorinated aliphatic hydrocarbon solvents (tetrachloroethene [PCE], trichloroethene [TCE], and 1,1,1-trichloroethane [1,1,1-TCA]) and their breakdown products (dichloroethane [DCA], dichloroethene [DCE], and vinyl chloride); lower concentrations of aromatic hydrocarbons (benzene, toluene, ethylbenzene, and xylene); and heavy metals. Because of the high concentrations of chlorinated solvent compounds in groundwater above the B clay, DNAPL occurrences are suspected at several locations beneath Site 9. If present, DNAPL may act as a long-term source of dissolved-phase contamination in the unconfined aquifer.

Contaminants in soils consist of heavy metals, VOCs, and semivolatile organic compounds (SVOC). Eighteen priority pollutant VOCs were detected in soil samples with individual compound concentrations of up to 3,600 milligrams per kilogram (mg/kg). Fourteen priority pollutant SVOCs, including

polynuclear aromatic hydrocarbons (PAH), were detected in soil samples with individual compound concentrations up to 1,668 mg/kg. In the former release areas, soils reportedly are virtually saturated with VOCs (Jacobs 1995a). In addition, large quantities of VOCs are believed to have evaporated from saturated soils and groundwater into the vadose zone. Elevated levels of TCE, PCE, and toluene have been detected in soil gas within the vadose zone.

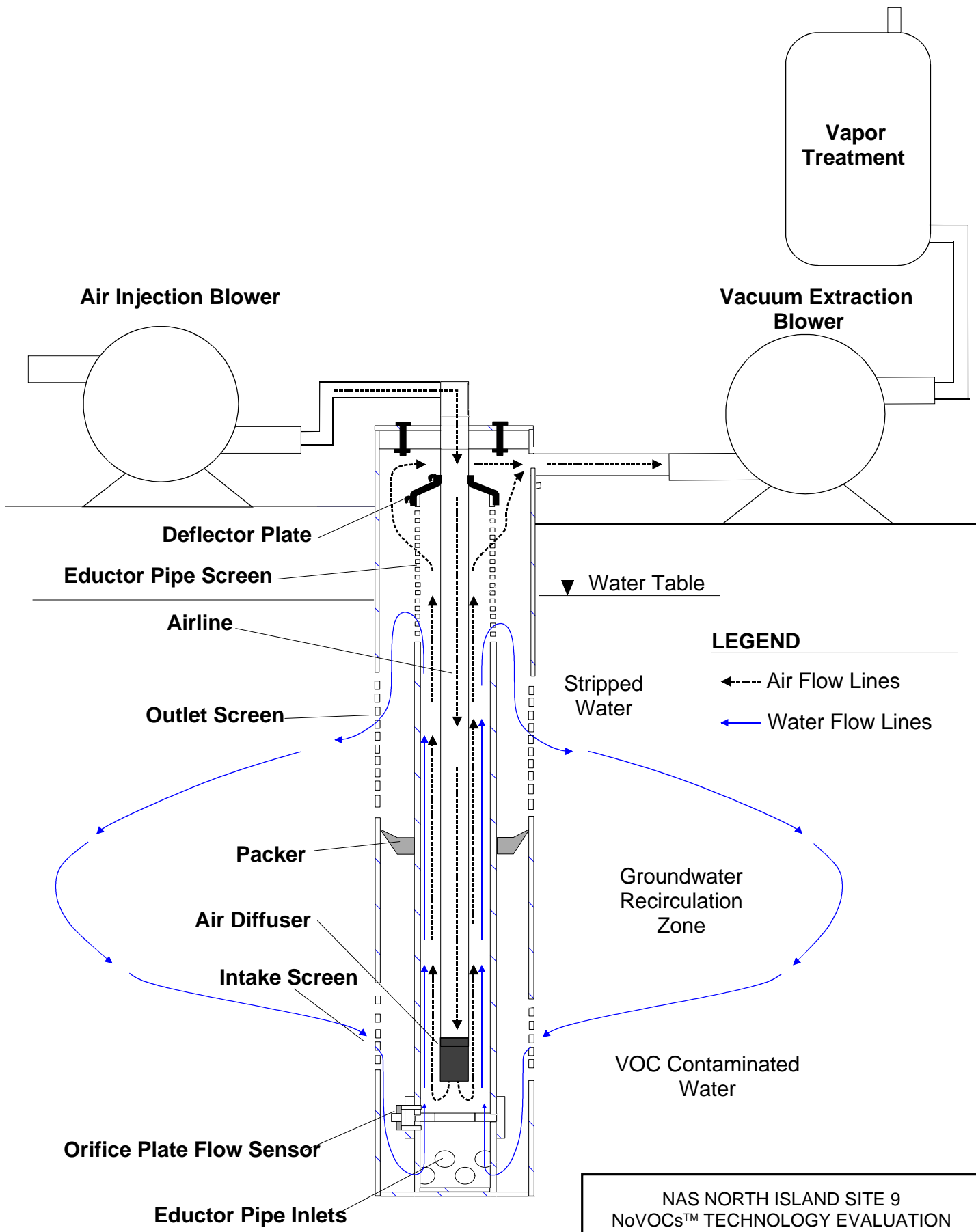

LEGEND
 ←--- Air Flow Lines
 ← Water Flow Lines

NAS NORTH ISLAND SITE 9
 NoVOCs™ TECHNOLOGY EVALUATION

FIGURE 2-1
NoVOCs™ SYSTEM

Tt Tetra Tech EM Inc.

Not to scale

MODIFIED FROM MACTEC 1998



4th STREET WEST

EXISTING SVE PAD

NoVOCS-THERMATRIX
EQUIPMENT PAD

PROPANE TANKS

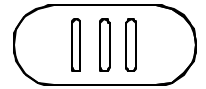

N 3rd STREET WEST

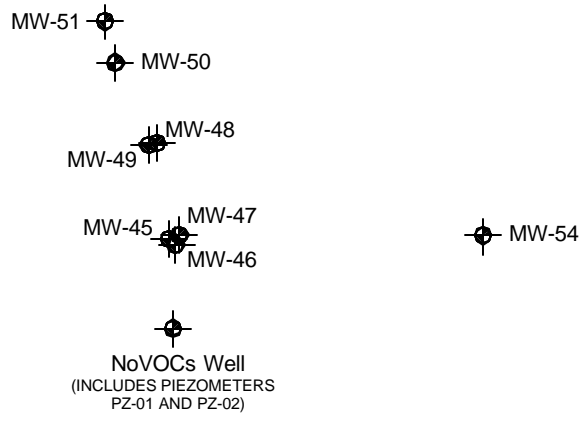

LEGEND



APPROXIMATE LOCATION OF
MONITORING WELL OR NoVOCS WELL





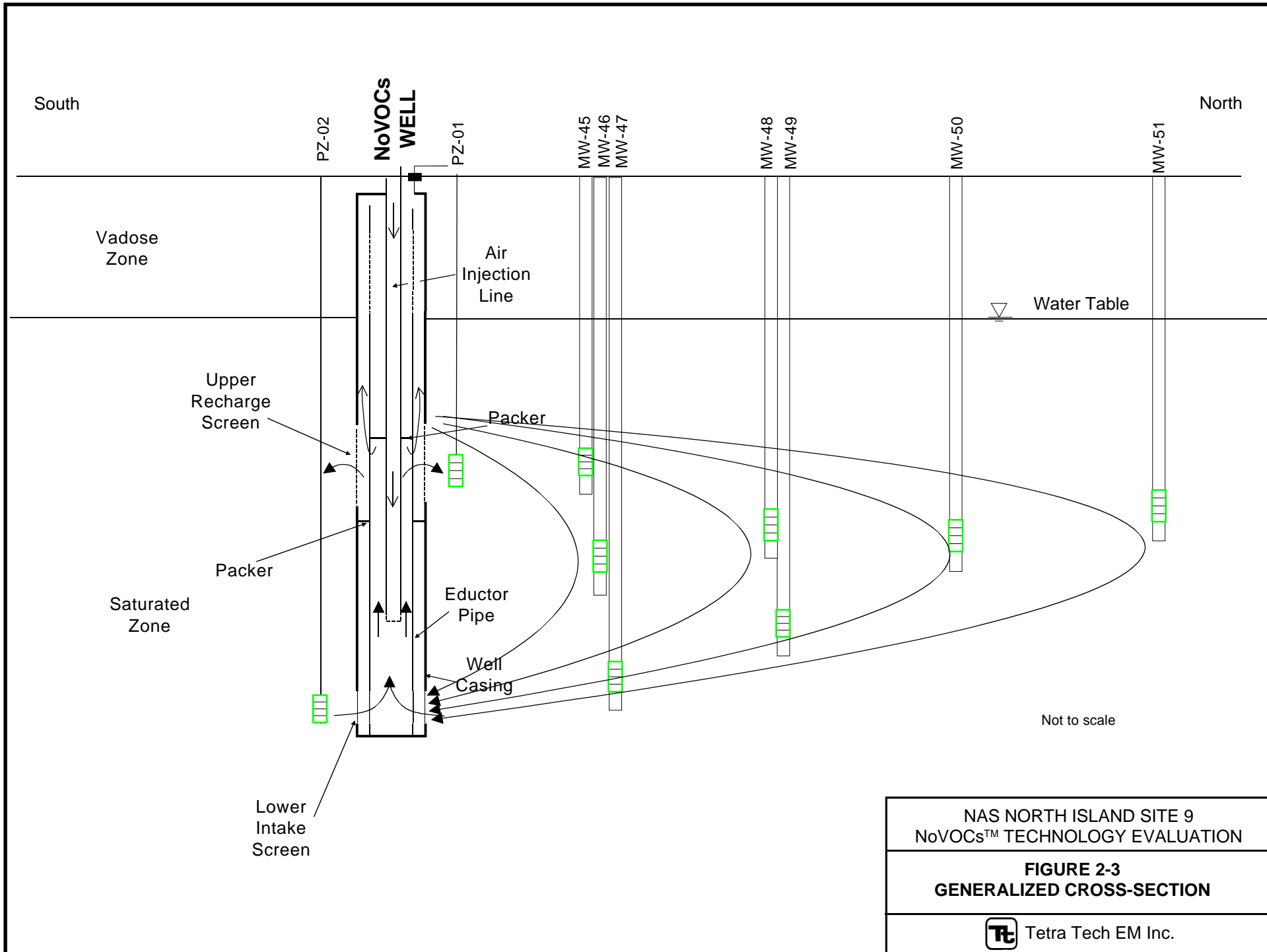

NAS NORTH ISLAND SITE 9
NoVOCS™ HYDROGEOLOGICAL INVESTIGATION

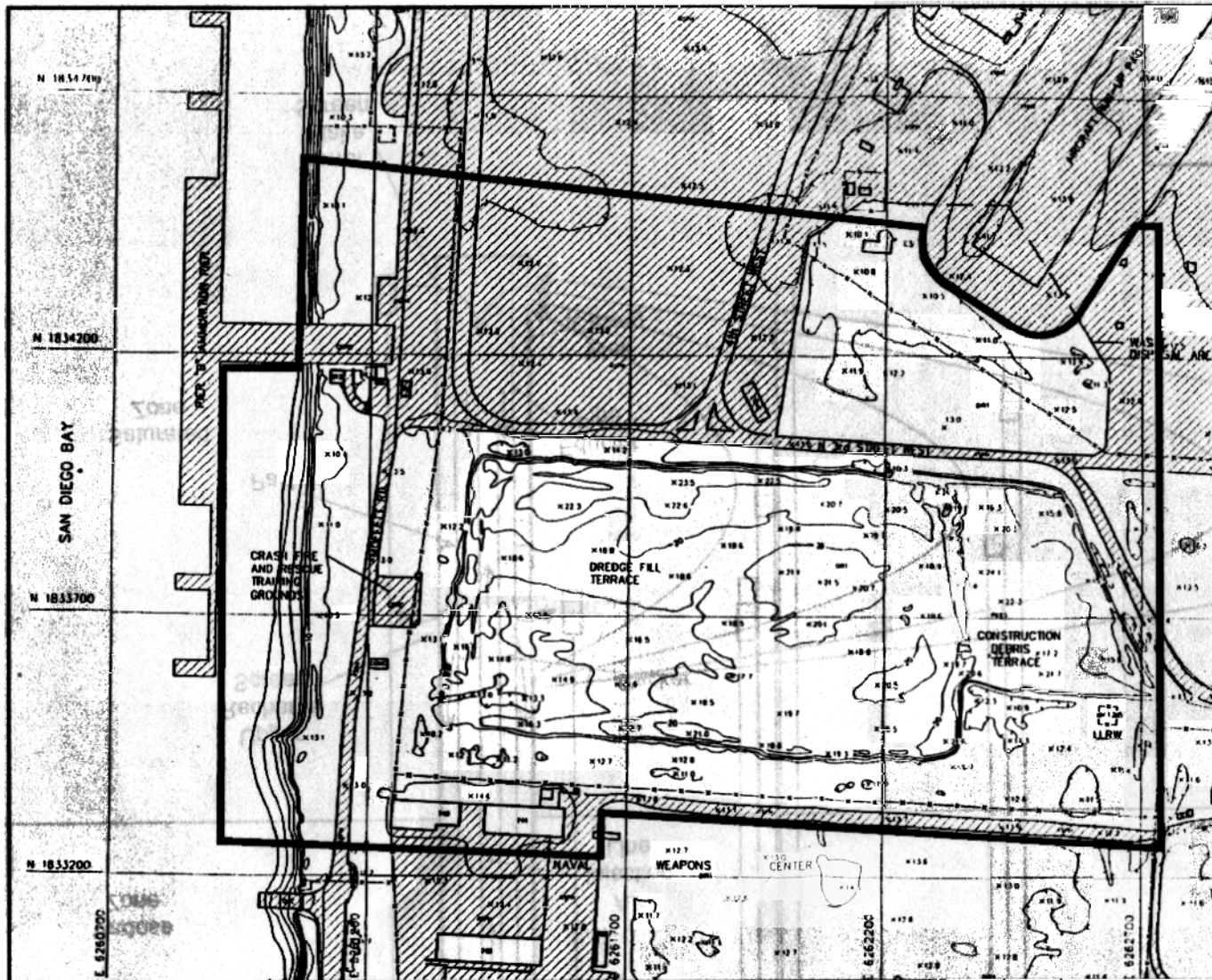
FIGURE 2-2
WELL LOCATIONS





LEGEND

-  20 CONTOUR LINE
-  FENCE
-  ROAD AND STREET
-  BUILDING
- X 12.3 SPOT ELEVATION
-  PAVEMENT (CONCRETE OR ASPHALT)
- LLRW LOW-LEVEL RADIOACTIVE WASTE STORAGE AREA
- SITE 9 BOUNDARY

NOTES:

1. BASE MAP ADAPTED FROM PHOTGRAMMETRY BY BECHTEL NATIONAL, INC., 1984.
2. ELEVATION DATUM IS MEAN LOWER LOW WATER.
3. COORDINATES ARE IN THE CALIFORNIA COORDINATE SYSTEM (1983) ZONE 6 BASED ON THE NORTH AMERICAN DATUM (1983).



NAS NORTH ISLAND SITE 9
NoVOCs™ HYDROGEOLOGICAL INVESTIGATION.

FIGURE 2-4
SITE 9 TOPOGRAPHIC ELEVATIONS

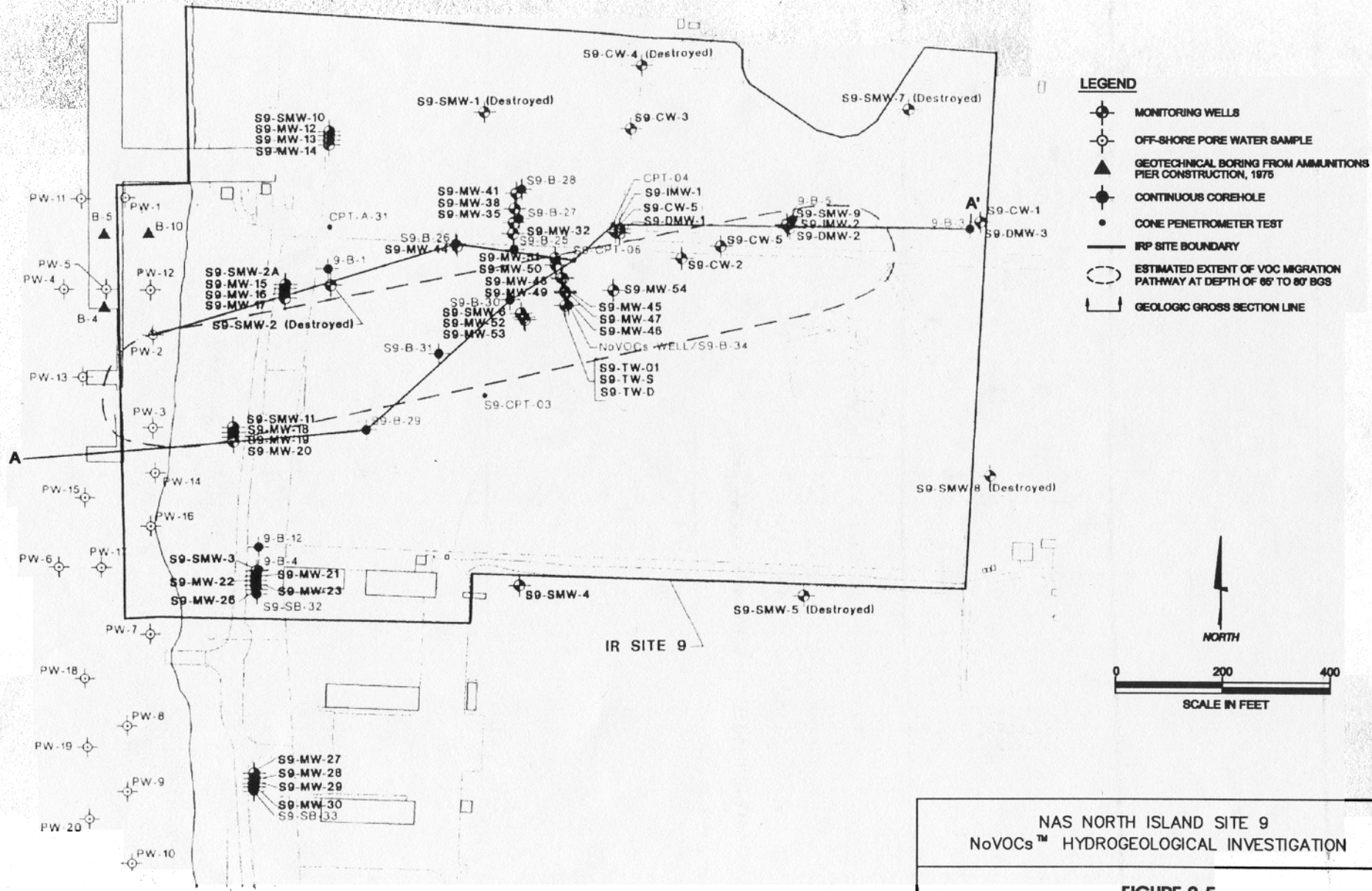

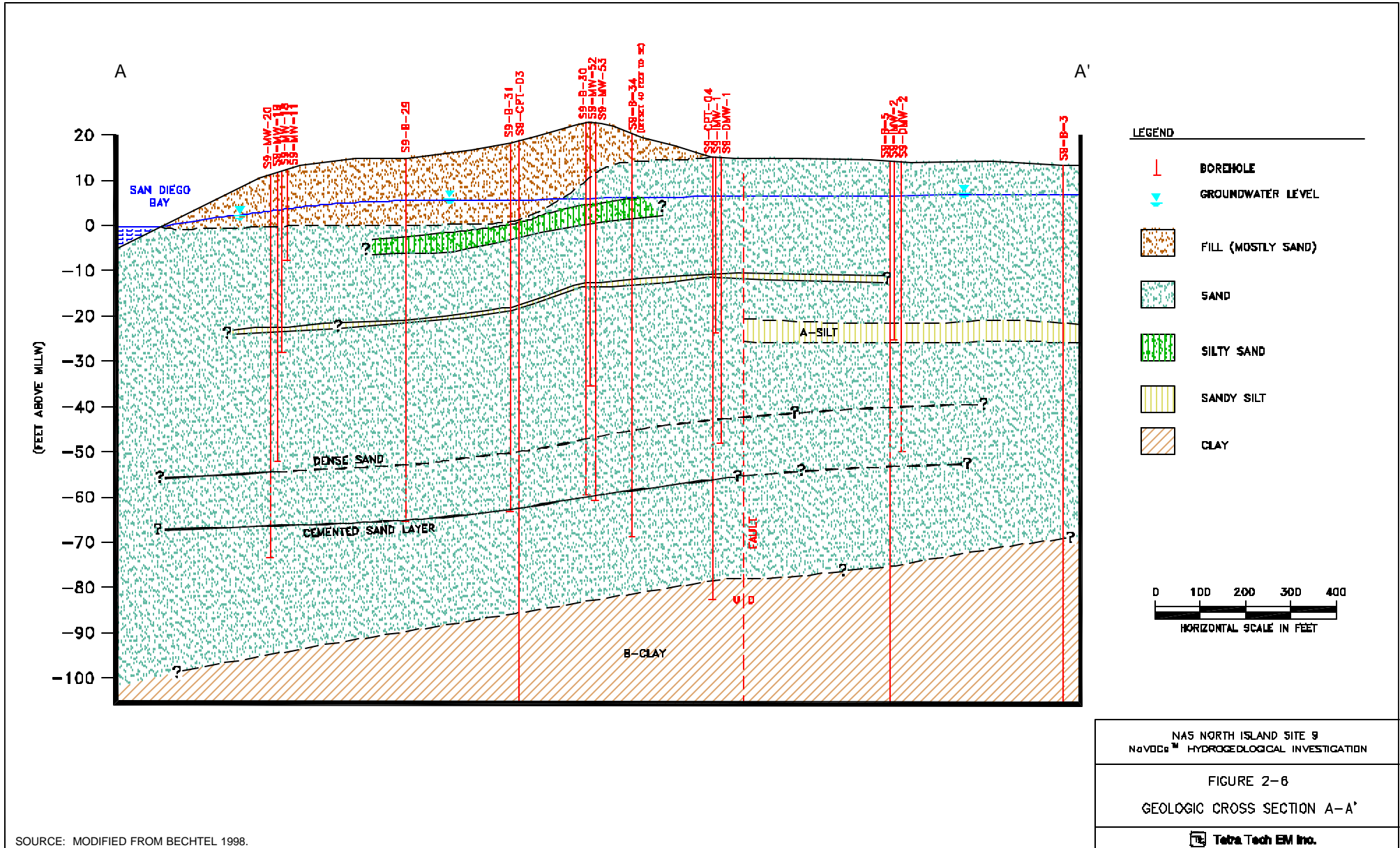

SOURCE: MODIFIED FROM BECHTEL 1998.

NAS NORTH ISLAND SITE 9
 NaVOCs™ HYDROGEOLOGICAL INVESTIGATION

FIGURE 2-6
 GEOLOGIC CROSS SECTION A-A'

TABLE 2-1

**WELL SCREEN INTERVALS
NoVOCs HYDROGEOLOGICAL INVESTIGATION
NAS NORTH ISLAND**

Well	Description	Distance From NoVOCs Well (feet)	Screen Interval	
			Depth (feet bgs)	Elevation (feet relative to MLLW)
IW-01	NoVOCs well	0	43 to 47 and 72 to 78	-21.3 to -25.3 and -50.3 to -56.3
MW-45	Cross-gradient monitoring well	29.8	42 to 47	-20.0 to -25.0
MW-46	Cross-gradient monitoring well	27.7	57 to 62	-35.4 to -40.4
MW-47	Cross-gradient monitoring well	31.1	72 to 78	-49.9 to -55.9
MW-48	Cross-gradient monitoring well	61.9	52 to 57	-28.6 to -33.6
MW-49	Cross-gradient monitoring well	61.7	67 to 72	-43.6 to -48.6
MW-50	Cross-gradient monitoring well	90.7	52 to 57	-36.9 to -41.9
MW-51	Cross-gradient monitoring well	104.6	49 to 54	-35.1 to -40.1
MW-52	Downgradient monitoring well	93.0	41 to 46	-19.1 to -24.1
MW-53	Downgradient monitoring well	93.1	72 to 77	-50.4 to -55.4
MW-54	Upgradient monitoring well	107.9	38 to 78	-18.0 to -58.0

Notes:

bgs Below ground surface

MLLW Mean lower low water level

3.0 TIDAL INFLUENCE STUDY

This section describes the configuration for and procedures of the tidal influence study and presents its results. The NoVOCs™ system began operation during the tidal influence study. The effects of NoVOCs™ system operation on groundwater levels is also discussed.

3.1 CONFIGURATION AND PROCEDURES

Tetra Tech conducted a tidal influence study from April 20 through 30, 1998 to measure natural fluctuations in water level at the site caused by tidal influences. Water level changes in the aquifer caused by NoVOCs™ system operation were also recorded because the system was started and shut down multiple times during the study period. Tetra Tech installed pressure transducers in nine observation wells in the immediate vicinity of the NoVOCs™ system and measured changes in water levels in the observation wells before system startup and during system operation. Measurements were collected before startup of the NoVOCs™ system to measure natural fluctuations in water levels at the site caused by tidal influences and to establish baseline groundwater elevation conditions. Water levels were measured during system startup and operation to assess the magnitude and extent of the water level changes caused by the NoVOCs™ system. This information was used to assist in evaluating the extent of the NoVOCs™ treatment cell.

To document water level changes in the aquifer caused by the NoVOCs™ system, Aquistar pressure transducers were installed in observation wells MW-45 through MW-53 (Figure 2-2). Transducers were not installed in piezometers PZ-01 and PZ-02 because the inner diameters of the piezometers were smaller than the outer diameter of the transducers. The installation of a transducer in observation well MW-54 was precluded by the presence of a multilevel diffusion sampler inside the well.

The pressure transducers had a 3/4-inch outer diameter and were rated at 15 pounds per square inch (psi). All of the transducers are automatically compensated with barometric pressure changes (i.e., the pressure transducer readings are automatically adjusted to current atmosphere pressure). The transducers were installed approximately 6 feet below the water surface, and water level elevations were measured manually using an electronic water level sounder in each observation well immediately before the transducers were installed. Each transducer was connected to either a single- or multi-channel data logger. Before the transducers were installed, the data loggers were programmed to collect pressure readings every 10 minutes. The pressure readings are converted to feet of water above the transducer and

then to water level elevation. The transducers were used to collect groundwater elevation data from the observation wells from April 20 to 30, 1998. The transducers were removed from the observation wells on April 30, 1998. Water level readings were obtained with an electronic sounder before the transducers were removed to provide an additional accuracy check.

3.2 RESULTS

This section presents the results of the tidal influence study that was conducted to evaluate natural fluctuations in water levels at the site caused by tidal influences. The changes in water levels recorded in each of the observation wells were plotted versus time. These plots are presented in Appendix B. Figures B1 through B4 depict the fluctuations in water levels in the observation wells over the 10-day duration of the study. Figures B5 through B8 present the water levels in the observation wells for 12 hours of the first day of NoVOCsTM system operation. Figure B9 shows the water level fluctuation in San Diego Bay during the tidal study. The tidal influence and NoVOCsTM system influence are discussed separately in the following sections.

3.2.1 Tidal Influence

This section summarizes the effects of tidal influence on the groundwater levels. A detailed discussion of the analysis of the tidal influence study data is provided in Section 5.1.

Based on Figures B1 through B4, the water level readings follow a cyclical pattern in all observation wells included in the tidal study. Figures B1 through B4 illustrate the increase and decrease in groundwater levels caused by tidal fluctuations in San Diego Bay. Maximum groundwater level fluctuations measured in the observation wells ranged from 0.56 to 0.73 feet, depending on the location of the observation well. The amplitudes of the tidal fluctuations in water levels were highest for observation wells closest to San Diego Bay (MW-52 and MW-53). The other observation wells monitored during the tidal influence study (MW-45 through MW-51) are all located at approximately the same distance from San Diego Bay; the amplitudes of the tidal fluctuations in these wells are similar to one another.

The cyclical pattern of groundwater level fluctuation can be seen for all observation wells and correlates with published tide charts for San Diego Bay with a time lag ranging from approximately 46 to 96 minutes, depending on observation well location and magnitude of the tidal fluctuation. The time lag also depends on the degree of hydraulic communication between the bay and the wells. The range of time

lags is similar for each of the observation wells because of the similar distance relative to San Diego Bay. The aquifer zone is generally in good hydraulic communication with the San Diego Bay.

3.2.2 NoVOCs™ System Influence

Figures B5 through B8 show groundwater elevations during approximately 12 hours of the first day of the study that included several NoVOCs™ system startups and shutdowns. Table 3-1 lists the start and stop times for the NoVOCs™ system on April 20, 21, and 22, 1998, as reported by the Navy. Groundwater level changes caused by startup and shutdown of the NoVOCs™ system on April 20, 1998, are evident in the water level data for well cluster MW-45, MW-46, and MW-47, located approximately 30 feet from the NoVOCs™ well (Figure B5). The water level data for observation wells MW-45 (the upper screened well in this cluster) and MW-46 (intermediate screened well) show water level increases after system startup. The groundwater elevation increase in well MW-45 was approximately 0.15 foot of water. Observation well MW-46, the intermediate depth well, shows a water level increase of approximately 0.05 foot of water. Observation well MW-47, the deep screened well, shows a water level decrease of approximately 0.025 foot. This pattern of water level increases and decreases associated with the operation of the NoVOCs™ system is expected based on the monitoring well screen locations relative to the NoVOCs™ well screen locations. The deep screened well experiences a drop in water level as water is drawn toward the NoVOCs™ well intake, and the upper screened wells experience increases in water level as water is lifted inside the NoVOCs™ well, and discharges into the upper aquifer. In well pair MW-48 and MW-49 (located approximately 62 feet from the NoVOCs™ well) and in wells MW-50 and MW-51 (located approximately 91 and 105 feet, respectively, from the NoVOCs™ well), water level changes associated with NoVOCs™ system operation are not apparent (Figures B6, B7, and B8).

TABLE 3-1

**START AND STOP TIMES FOR THE NoVOCs SYSTEM
NoVOCs HYDROGEOLOGICAL INVESTIGATION
NAS NORTH ISLAND**

Date	Time^a	Action
April 20, 1998	10:01	Start
	10:01	Stop
	10:04	Start
	10:05	Stop
	10:18	Start
	10:24	Stop
	15:54	Start
	16:20	Stop
	18:08	Start
	18:32	Stop
	18:50	Start
	18:51	Stop
	18:56	Start
	19:00	Stop
	19:10	Start
April 21, 1998	16:20	Stop
	16:23	Start
	16:40	Stop
	18:45	Start
April 22, 1998	12:30	Stop
	13:03	Start
	13:12	Stop
	13:40	Start
	14:01 through 14:19	Six stop and start cycles to check auto shutdown functions
	14:19	Start (system in continuous operation)

Note:

a Rounded to nearest minute

4.0 AQUIFER TESTING

A series of aquifer tests were conducted at the demonstration site from July 27 through August 5, 1998, to obtain information on hydraulic communication between various portions of the aquifer beneath the site, as well as data for estimating values of aquifer hydraulic parameters such as hydraulic conductivity, transmissivity, storativity, and anisotropy. In addition, the aquifer tests were conducted to obtain data for calculating well efficiencies for the two screened intervals of the NoVOCs™ well.

Aquifer testing was conducted using the NoVOCs™ well (IW-01) as the pumping or injection well. Two piezometers and 10 observation wells were available for water level measurements. An inflatable packer was used to isolate the two screened intervals within the NoVOCs™ well to allow pumping from each screened interval separately. The aquifer tests, in the order conducted, were as follows:

- Step drawdown test in the upper screened interval conducted on July 27, 1998
- A 32-hour constant discharge pumping test in the upper screened interval conducted on July 28 and 29, 1998
- Injection test in the upper screened interval conducted on July 31, 1998
- Step drawdown test in the lower screened interval conducted on August 1, 1998
- Dipole flow test with pumping in the lower screened interval and injection in the upper screened interval conducted on August 5, 1998

A constant discharge pumping test for the lower screened interval was not conducted because of the excessive volume of water that would be generated and the prohibitive cost of water disposal.

4.1 PRETESTING ACTIVITIES

Before initiating the aquifer tests, certain downwell components of the NoVOCs™ system were removed, the well screens and filter pack were redeveloped, and aquifer testing equipment was installed. A description of each pretesting activity is provided in the following subsections.

4.1.1 NoVOCs™ Equipment Removal

To allow access for aquifer testing equipment, downwell components of the NoVOCs™ system were removed, except for the 8-inch diameter outer casing and the prepacked screen on the eductor casing at 72 to 78 feet bgs (-50.4 to -58.0 feet MLLW). In addition, piezometers, PZ-01 and PZ-02, set in the filter pack adjacent to the intake and recharge screens of the NoVOCs™ well, were not removed and were used as monitoring points during the aquifer tests. The downhole components removed included the 5-inch, schedule 40 polyvinyl chloride (PVC) eductor casing, the 2-inch PVC airline and diffuser, all packers, and downhole probes and meters.

4.1.2 Video Survey and Well Screen Development

To assess the condition of the NoVOCs™ well screens, a downhole video camera was lowered into the well to visually inspect the condition of the well casing and well screens. Two downwell video surveys of the NoVOCs™ well were conducted: one after internal NoVOCs™ well components were removed, and the other after well redevelopment and cleaning of the well screens. The camera was lowered on a taped cable so that the depth of the camera was known. The camera was capable of rotating up to 360 degrees on command. During the initial video survey, heavy orange iron staining on the well casing and well screens was observed. In addition, excessive orange iron flocculant was observed in the water column along with orange iron bioslime in the well screen intervals. Orange iron precipitant was also observed on the eductor pipe, eductor screen, and air line during removal of the internal well components. These observations suggest that iron precipitation and microbiological growth in the well are occurring. Both of these factors may impair the performance of the NoVOCs™ system by obstructing the well screen and filter pack material. Groundwater samples collected from the well by MACTEC confirmed that microorganisms were present in the NoVOCs™ well at high levels (Personal Communication from Scott Donovan, Bechtel 1998).

To remove the microbiological growth and precipitant, the well was redeveloped using surge and pump methods and hydrochloric acid was added to the well water. Approximately 2.5 gallons of hydrochloric acid were tremmied into the upper and lower screen intervals of the NoVOCs™ well, and the well water was agitated for a period 30 minutes. After cleaning the NoVOCs™ well screens with acid, the video camera was lowered into the well a second time to evaluate the effectiveness of well cleaning and development.

The second video survey showed that redevelopment and cleaning were effective in removing precipitant and microbiological growth in the well screens. In addition, the orange iron flocculant was removed from the water column within the well. Review of the integrity of the well casing during the second survey indicated that the well was intact with no signs of damage. However, a manufacturing defect in the upper well screen was observed. The screen slots in the upper well screen are unevenly cut, and about 30 percent of the slots do not completely penetrate the PVC casing. This defect limits the efficiency of the upper screen interval and may reduce the available water level rise in the NoVOCs™ well during recharge into the aquifer through the upper screen interval.

4.1.3 Aquifer Test Equipment Installation and Configuration

The first set of aquifer tests were conducted in the upper screened interval of the NoVOCs™ well and consisted of step drawdown, constant discharge, and injection tests. The second set of aquifer tests were conducted in the lower screened interval of the NoVOCs™ well and consisted of step drawdown and dipole flow tests. This section describes installation and configuration of aquifer testing equipment.

Pump and Packer

Pumping equipment configuration was identical for the step drawdown test and constant discharge pumping test conducted in the upper screened interval (Figures 4-1 and 4-2). To pump only the upper screened interval of the NoVOCs™ well, the two screened intervals were hydraulically separated using a 5-inch-diameter by 5-foot-long inflatable Baski packer. The inflatable packer was set between the two screened intervals at a depth of approximately 62 to 67 feet bgs (-40.3 to -45.3 feet MLLW). The pump used for the aquifer tests was a 4-inch stainless steel Grundfos submersible pump with a capacity of 100 gallons per minute. The pump was installed above the packer with its intake at approximately 55 feet bgs (-33.3 feet MLLW). The pump and the packer system were set in the NoVOCs™ well using a 2-inch diameter steel drop pipe (Figure 4-1). The drop pipe was secured at the well head and connected to a 2-inch diameter PVC discharge line. After the pump was set, the packer was inflated to a pressure of 70 pounds per square inch using a pressurized nitrogen cylinder. The packer's pressure was monitored throughout the pumping tests at the well head using a pressure gauge. The same equipment was used for the stepdrawdown and dipole flow tests conducted in the lower screened interval of the NoVOCs™ well (Figures 4-4 and 4-5). The packer was installed at approximately 56 to 61 feet bgs (-34.3 to -39.3 feet MLLW) and the submersible pump was set immediately below the packer at approximately 65 feet bgs (-43.3 feet MLLW).

Pressure Transducers and Data Loggers

Pressure transducers manufactured by Aquistar were installed in observation wells MW-45 through MW-54 and in the pumping well (one transducer above the packer system and one transducer below the packer). The pressure transducers used were pressure rated between 5 and 30 psi. The higher pressure rating transducers were installed in wells anticipated to exhibit the greatest change in water level (observation wells MW-45 through MW-49 and the pumping well). Transducers with pressure ratings of 5 psi were installed in observation wells farthest from the NoVOCs™ well (MW-50 through MW-54) because smaller changes in water levels were expected during the pumping tests.

The transducers were connected to single- and multi-channel data loggers. The pressure readings by the transducers were automatically adjusted to the atmosphere pressure so that no barometric pressure correction is needed for the pressure/water level readings by the transducers. In addition, barometric efficiency was expected to be low for the testing aquifer under unconfined condition. Therefore, barometric efficiency was not calculated and barometric pressure correction for observed water levels was not conducted.

During transducer installation, the depth to groundwater was measured with an electronic water level sounder before lowering the transducer into the well. The pressure transducer was then connected to the data logger and the transducer was lowered into the well. The transducer was set at a depth so that it would remain submerged during the pumping test at a depth below water not exceeding the pressure rating of the transducer. The pressure transducer cable was secured to the well head and the surface using duct tape, so that no movement occurred during the pumping test. After the transducer was secured, a reading of the length of the column of water above the transducer was recorded.

During the aquifer tests, the data loggers for the NoVOCs™ well and observation wells MW-45, MW-46, and MW-47 were constantly connected to a laptop computer to view recorded data. Data loggers for observation wells MW-48 through MW-54 were periodically connected to a laptop to confirm that water level readings were being recorded properly. In addition, transducer data were periodically checked by collecting water level measurements using an electronic water level sounder.

Other Equipment

During the aquifer tests, the pumping and injection rates were regulated using a variable rate controller, a flow control valve, and two inline flow meters. The flow meters used were a McCrometer electronic flow meter with totalizer and a Precision flow meter with totalizer. The meters were installed on the discharge pipe at the well head. The flow meters were calibrated in the field by measuring the time required to fill a 5-gallon bucket with water pumped through the discharge line.

All water generated during the pumping tests was piped to on-site storage tanks to await chemical characterization and subsequent disposal. To accommodate the volume of water generated during the pumping tests, four 20,000-gallon tanks were staged on site for storage of the extracted groundwater. Water quality parameters including pH, oxidation and reduction potential, specific conductance, temperature, and dissolved oxygen were measured during development and removal of the well water. Horiba U10 and YSI 2000 water quality meters were used to measure the water quality parameters in the field. The instruments were calibrated daily in accordance with the manufacturer's instructions.

4.1.4 Data Logger Programming

The data loggers were programmed using the length of the column of water above the transducer, depth of water below the top of well casing, and the survey elevation on the top of the casing so that subsequent readings were relative to MLLW. The data loggers were programmed for each pumping test to collect data at specific times and frequencies. Because of significant water level responses to changes in pumping rate (including starting and stopping pumping), the data loggers for the NoVOCs™ well and observation wells MW-45 through MW-47 were programmed to collect data at a higher frequency immediately following any change in pumping rate. The programmed data collection schedule was as follows: every half-second for 20 readings, every second for 50 readings, every 2 seconds for 60 readings, every 5 seconds for 60 readings, every 10 seconds for 30 readings, every minute for 20 readings, every 2 minutes for 20 readings, every 5 minutes for 12 readings, every 10 minutes for 18 readings, and every 20 minutes for 500 readings. (This schedule was reinitiated following any change in pumping rate and was generally terminated before the last step reached completion.) Collecting water level measurements in this manner provided data at higher frequencies when the rate of water level change was greater. Data loggers for observation wells MW-48 through MW-54 were programmed to collect data at lower frequencies, typically once per minute. All data were downloaded from the data logger to a computer and the data logger was reset between each aquifer test.

4.2 STEP DRAWDOWN TEST OF THE UPPER SCREENED INTERVAL

Tetra Tech conducted a step drawdown test in the upper screened interval of the NoVOCs™ well to estimate the optimal pumping rate for a constant discharge pumping test, and to estimate the well efficiency and specific capacity of the upper screened interval of the NoVOCs™ well. Test procedures and results are discussed below.

4.2.1 Procedures

On July 22, 1998, Tetra Tech conducted an initial step drawdown test on the upper screened interval of the NoVOCs™ well to estimate the optimal pumping rate for a constant discharge pumping test and the well efficiency and specific capacity of the upper screened interval of NoVOCs™ well. The step drawdown test was conducted by separating the upper and lower screened sections of the NoVOCs™ well using a packer system and pumping the upper screened interval of the well with a submersible pump (Figure 4-1), as described in Section 4.1.3. Based on observations of water levels in the recharge and intake piezometers (PZ-01 and PZ-02), the integrity of the inflatable packer seal between the upper and lower screens was determined to have been compromised during the initial test.

A second step drawdown test in the upper screened interval of the NoVOCs™ well was conducted on July 27, 1998. During the second test, water was first pumped at a rate of 43 gpm for about 17 minutes to check the integrity of the packer system. The water level in piezometers PZ-01 and PZ-02 remained stable during pumping of the upper screened interval, indicating that the packer seal was effective. Water was then pumped at 10 gpm for 11 minutes, 15 gpm for 45 minutes, and 20 gpm for 45 minutes. Water levels in the NoVOCs™ well and the surrounding observation wells were monitored using pressure transducers to measure changes in water level within the aquifer. A summary of the step drawdown test for the upper screen interval of the NoVOCs™ well is provided in Table 4-1.

4.2.2 Results

The pressure transducer and hand measurement data from the NoVOCs™ well (upper and lower intervals) and observation wells MW-45 through MW-54 are presented in Appendix C as Figures C1 through C7. Results for observation well MW-49 are not available because of a data logger malfunction.

Decreases in water levels were recorded in the pumping well (Figure C1) and observation wells MW-45 through MW-54 (Figures C2 through C7). The water level changes in the pumping well and observation wells exhibited similar patterns in response to changes in pumping rate; however, the responses decreased with distance from the NoVOCs™ well and with depth of the observation wells. When pumping at 20 gpm, the pumping well exhibited a maximum water level decrease of about 14 feet; observation well MW-45 (approximately 30 feet from the pumping well) showed a water level decrease of 0.6 foot; and observation well MW-51 (about 105 feet from the pumping well), showed a water level decrease of about 0.03 foot. The observation wells exhibited an almost immediate response to changes in pumping rate, suggesting that the aquifer has good communication in both the horizontal and vertical directions.

4.3 CONSTANT DISCHARGE PUMPING TEST OF THE UPPER SCREENED INTERVAL

A constant discharge pumping test in the upper screened interval was conducted following the step drawdown test in the upper screened interval of the NoVOCs™ well and following complete water level recovery in the pumping well, the observation piezometer, and the observation wells. Constant discharge pumping test procedures and results are discussed below.

4.3.1 Procedures

Based on the results of the step drawdown test (Section 4.2.2), 20 gpm was selected as the pumping rate for the constant discharge pumping test in the upper screening interval of the NoVOCs™ well. On July 28 through 30, 1998, Tetra Tech conducted a constant discharge pumping test to estimate the hydraulic conductivity, transmissivity, storativity, and anisotropy of the shallow aquifer. The constant discharge pumping test was conducted by isolating the upper and lower screened intervals of the NoVOCs™ well using a packer system and pumping the upper screened interval of the well with a submersible pump (Figure 4-2), as described in Section 4.1.3. Water was pumped at a constant discharge of 20 gpm for about 32 hours. Afterward, recovery data from the pumping well and the observation wells were collected for 24 hours. Recovery rates were recorded in the pumping well and all observation piezometers and wells. Pumping equipment remained in the pumping well until recovery monitoring was complete. Water levels in the NoVOCs™ well and the surrounding observation wells were monitored using pressure transducers to measure changes in water level within the aquifer. A summary of the constant discharge pumping test for the upper screened interval of the NoVOCs™ well is provided in Table 4-2.

4.3.2 Results

The pressure transducer and hand measurement data from the NoVOCs™ well and observation wells MW-45 through MW-54 are presented in Appendix D as Figures D1 through D6. Results for observation well MW-50 are not available because of a data logger malfunction.

Drawdown in the pumping well was measured at about 16 feet. With the exception of the pumping well, changes in water levels in the observation wells are difficult to discern without tidal corrections to determine actual drawdown. Tidal corrections for the constant discharge pumping test data are discussed and applied in Section 5.1.

4.4 INJECTION TEST OF THE UPPER SCREENED INTERVAL

The pumping equipment used for the step drawdown and constant discharge pumping tests were left in the well for the injection test in the upper screened interval. Injection test procedures and results are discussed below.

4.4.1 Procedures

The injection test was conducted in the NoVOCs™ well by injecting a constant rate of potable water through the upper screened interval of the NoVOCs™ well. Clean tap water was brought to the site using a fire hose and was stored adjacent to the NoVOCs™ well in a 300-gallon holding tank. Water was initially introduced to the NoVOCs™ well by gravity flow from the holding tank to the NoVOCs™ well. Water flow rates were controlled by a flow valve and were measured using an inline flow meter and totalizer. Flow rate was monitored closely so that a constant flow rate was injected. On July 30, 1998, approximately 1.5 hours after starting the injection test, water injection was terminated because particulate material was observed in the tap water being injected into the NoVOCs™ well. The particulate material was identified as scaling from the hose used to transport the potable water. Approximately 1,200 gallons of water had been injected during the initial injection test. To remove the particulate material injected, approximately 6,000 gallons of water was pumped from the upper screened interval of the NoVOCs™ well. To eliminate the particulate problem, the water storage tank was eliminated and a new fire hose was plumbed directly to the NoVOCs™ well through a flow control valve and inline flow meter (Figure 4-3). Before reinitiating water injection, the aquifer was allowed to stabilize overnight.

On July 31, 1998 through August 1, 1998, Tetra Tech conducted an injection test to obtain information on the recharge capacity and specific capacity of the upper screened interval of the NoVOCs™ well. Potable water was injected at rates of 5, 15, and 22 gpm for a period of about 1 hour at each rate. Potable water was also injected at a rate of 30 gpm for 4 minutes and 25 gpm for about 14 minutes. Based on the water injection rate and duration, a total of approximately 3,000 gallons of water was injected into the aquifer during the injection test. After water injection was stopped, water levels continued to be monitored for approximately 14 hours of recovery. A summary of the injection test for the upper screened interval of the NoVOCs™ well is provided in Table 4-3.

4.4.2 Results

The pressure transducer and hand measurement data from the NoVOCs™ well (upper and lower intervals), and observation wells MW-45 through MW-54 are presented in Appendix E as Figures E1 through E7. An increase in water level was recorded in the injection well and in observation wells MW-45 through MW-54. The water levels in the injection well and observation wells exhibited similar patterns in response to changes in pumping rate; however, the response decreased with distance from the NoVOCs™ well and with depth of the observation wells. The upper screened interval recharged clean tap water at a flow rate of 22 gpm for 1 hour with a 14.4 foot increase in water level. When the flow rate was increased to 30 gpm, the water level quickly increased another 3.6 feet to about 18 feet above the initial water level and began discharging at the ground surface. The injection rate was decreased to 25 gpm for about 15 minutes, during which groundwater elevations stabilized at about 17 feet above the initial water level. This information shows that the upper well screen can recharge clean tap water at an injection rate near the design pumping rate of the NoVOCs™ system (25 gpm). However, the injection rates were run for only 1 hour each and, therefore, the corresponding increase in water level may not represent complete stabilization of the aquifer.

4.5 STEP DRAWDOWN TEST OF THE LOWER SCREENED INTERVAL

After the injection test was completed and the aquifer had recovered, the pumping equipment was reconfigured for aquifer testing of the lower screened interval of the NoVOCs™ well (72 to 78 feet bgs). The procedures for and results of the step drawdown test of the lower screened interval are discussed below.

4.5.1 Procedures

On August 1 and 2, 1998, Tetra Tech conducted a step drawdown test to assess the well efficiency and specific capacity of the lower screened interval of the NoVOCsTM well. The step drawdown test was conducted by separating the upper and lower screened intervals of the NoVOCsTM well using a packer system and pumping the lower screened interval of the well with a submersible pump (Figure 4-4), as described in Section 4.1.3. Water was first pumped at a rate of 40 gpm for 10 minutes to check the integrity of the packer system. Water was then pumped at rates of 50, 64, and 30 gpm for a period of about 1 hour at each rate. After pumping stopped, water levels continued to be monitored for approximately 13 hours of recovery. A summary of the step drawdown test for the lower screened interval of the NoVOCsTM well is provided in Table 4-4.

4.5.2 Results

The pressure transducer and hand measurement data from the NoVOCsTM well (upper and lower intervals) and observation wells MW-45 through MW-54 are presented in Appendix F as Figures F1 through F7. Results for observation well MW-50 are not available because of data logger malfunction. A decrease in water level was recorded in the pumping well and observation wells MW45 through MW54. The water levels in the pumping well and observation wells exhibited similar patterns in responses to changes in pumping rate; however, the responses decreased with distance away from the NoVOCsTM well and with depth of the observation wells. A drawdown of greater than 20 feet was observed in the lower screened interval of the pumping well. The observation wells exhibited an almost immediate response to changes in pumping rate, suggesting that the aquifer has good communication in both the horizontal and vertical directions.

4.6 DIPOLE FLOW TEST

After the aquifer had recovered from the step drawdown test of the lower screened interval, the pumping discharge line was redirected to inject pumped water through the upper screened interval. The procedures for and results of the dipole flow test are discussed below.

4.6.1 Configuration and Procedures

On August 5 through 7, 1998, Tetra Tech conducted a dipole flow aquifer test (simultaneous pumping and injection of groundwater) to investigate groundwater circulation through the NoVOCs™ system and to calibrate the downhole inline flow meter. The dipole flow test was conducted by pumping a constant rate of groundwater from the lower screened section of the NoVOCs™ well and injecting groundwater into the upper screened section of the NoVOCs™ well (Figure 4-5). Groundwater was pumped and injected at rates of 5, 10, 15, 20, and 25 gpm for periods ranging from 54 to 71 minutes for each rate. Pumping and injection flow rates were measured using an inline flow meter. Flow measurement was also attempted using an orifice plate (the same orifice plate used in the NoVOCs™ well); however, the magnahelic used to measure pressure across the orifice plate was damaged during the test and reliable measurements could not be collected. Instead, pumping and injection flow rates were measured using an inline flow meter. A total of approximately 4,600 gallons of water were pumped and injected during the dipole flow test. A summary of the dipole flow test for the upper and lower screened sections of the NoVOCs™ well is provided in Table 4-5.

4.6.2 Results

Dipole flow test data are presented in Appendix G. Figure G-1 (Appendix G) shows pressure transducer data for the pumping and recharge intervals of the NoVOCs™ well. Hand measurements of water level rise at the upper recharge interval are also plotted. Drawdown data for the pumping interval show that the water level changed quickly and approached a steady state in a very short time. The drawdown recovery was just as rapid after the pump was turned off. This type of drawdown response makes analysis of transient state data difficult or impossible. In the other hand, water level rise data for the recharge interval show a longer transient stage at the beginning of each test step.

Pressure transducer and hand measurement data collected from the observation wells are presented in Figures G2 through G6 (Appendix G). As shown in Figure G2, well MW-45 shows a small water level rise during each step of the dipole flow test. In wells MW-46 and MW-47, some pressure response can be identified at the beginning of each step, but drawdown or water level rise cannot be positively measured at these two wells. Observation wells MW-48, MW-49, MW-51, MW52, MW53, and MW-54 showed very little or no response to the dipole flow test.

4.7 WATER QUALITY PARAMETERS

Water quality parameters including temperature, specific conductance, pH, reduction/oxidation potential, dissolved oxygen, salinity, and turbidity were measured in water from the pump discharge line during the pumping tests. A summary of the water quality parameter measurements is provided in Table 4-6. In general, results for the water quality parameters are higher in the lower screened zone, with the exception of pH and temperature. This finding is also supported by VOC concentration data from the wells at the demonstration site, which exhibit higher concentrations in samples from the deep wells than in samples from the shallow wells.

Specific conductance and salinity values measured during pumping of the upper screened interval averaged 22.2 micromhos per centimeter (Fmhos/cm) and 2.26 percent, respectively, while the same parameters measured during pumping of the lower screen interval averaged 27.4 Fmhos/cm and 2.71 percent. These results are consistent with the range of values and trend toward increased specific conductance and salinity with depth. Average temperature measured while pumping the upper and lower screened intervals was about 21.7 °C. Results of pH measurements while pumping the upper screened interval averaged 7.40, which was higher than the average pH value of 7.03 calculated from measurements collected when pumping the lower screened interval. The average reduction/oxidation potential in the upper interval was 22.7 millivolts (mv), while the average reduction/oxidation potential (Eh) in the lower interval was minus 30.5 mv. Dissolved oxygen concentrations also increased from an average of 7.92 milligrams per liter (mg/L) in the upper screened interval to 8.27 mg/L in the lower screened interval. Because the packer seal was not set appropriately during the July 22, 1998, step drawdown test in the upper screened interval, water quality measurements from the test were not used in calculating average water quality values.

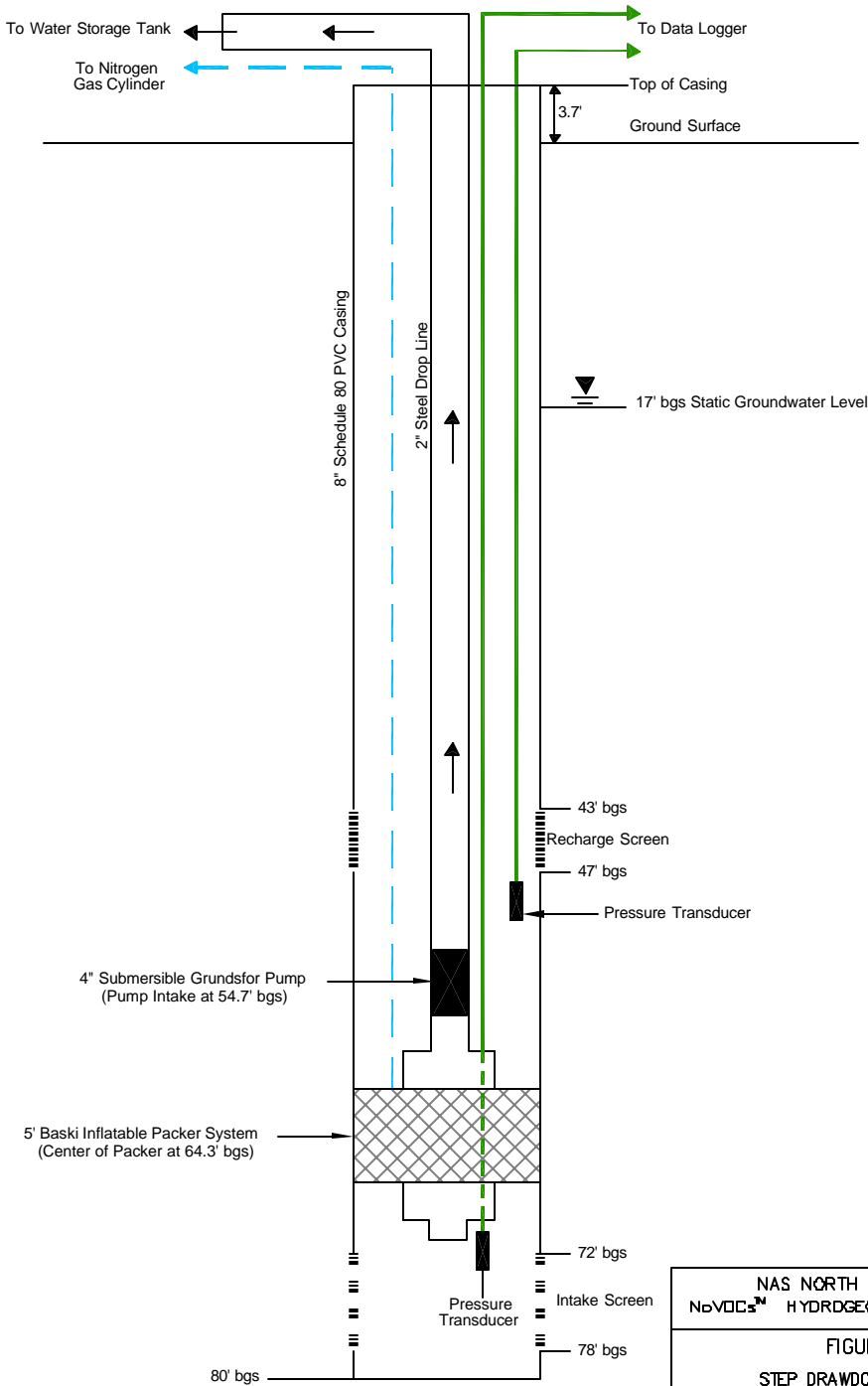

Vertical Scale: 1"=10'

NAS NORTH ISLAND SITE 9
 N_oVOCsSM HYDROGEOLOGICAL INVESTIGATION

FIGURE 4-1
 STEP DRAWDOWN TEST-UPPER
 SCREENED INTERVAL PUMPING WELL CONFIGURATION

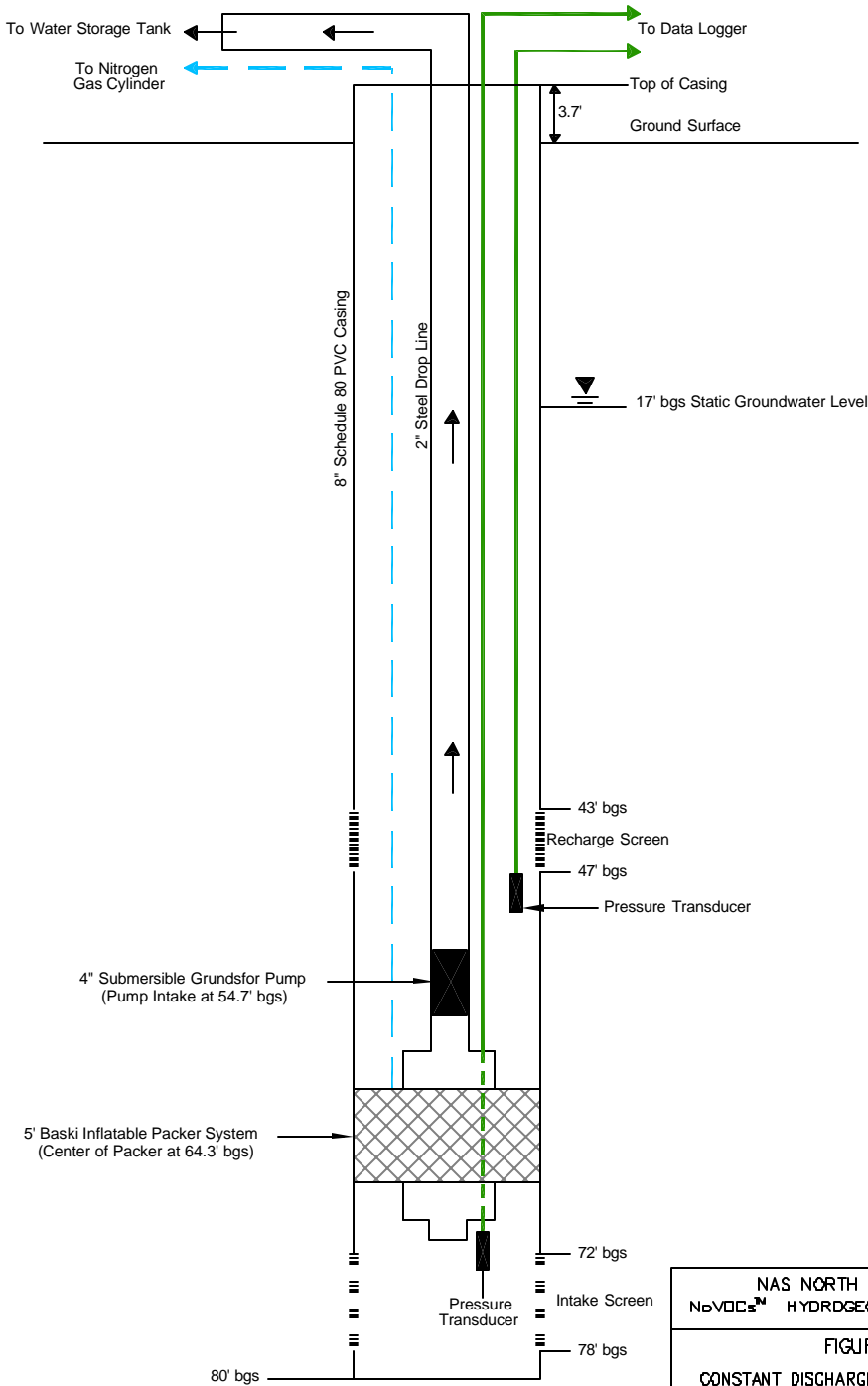

Vertical Scale: 1"=10'

NAS NORTH ISLAND SITE 9
 N_oVOCsTM HYDROGEOLOGICAL INVESTIGATION

FIGURE 4-2
 CONSTANT DISCHARGE PUMPING TEST-UPPER
 SCREENED INTERVAL PUMPING WELL CONFIGURATION

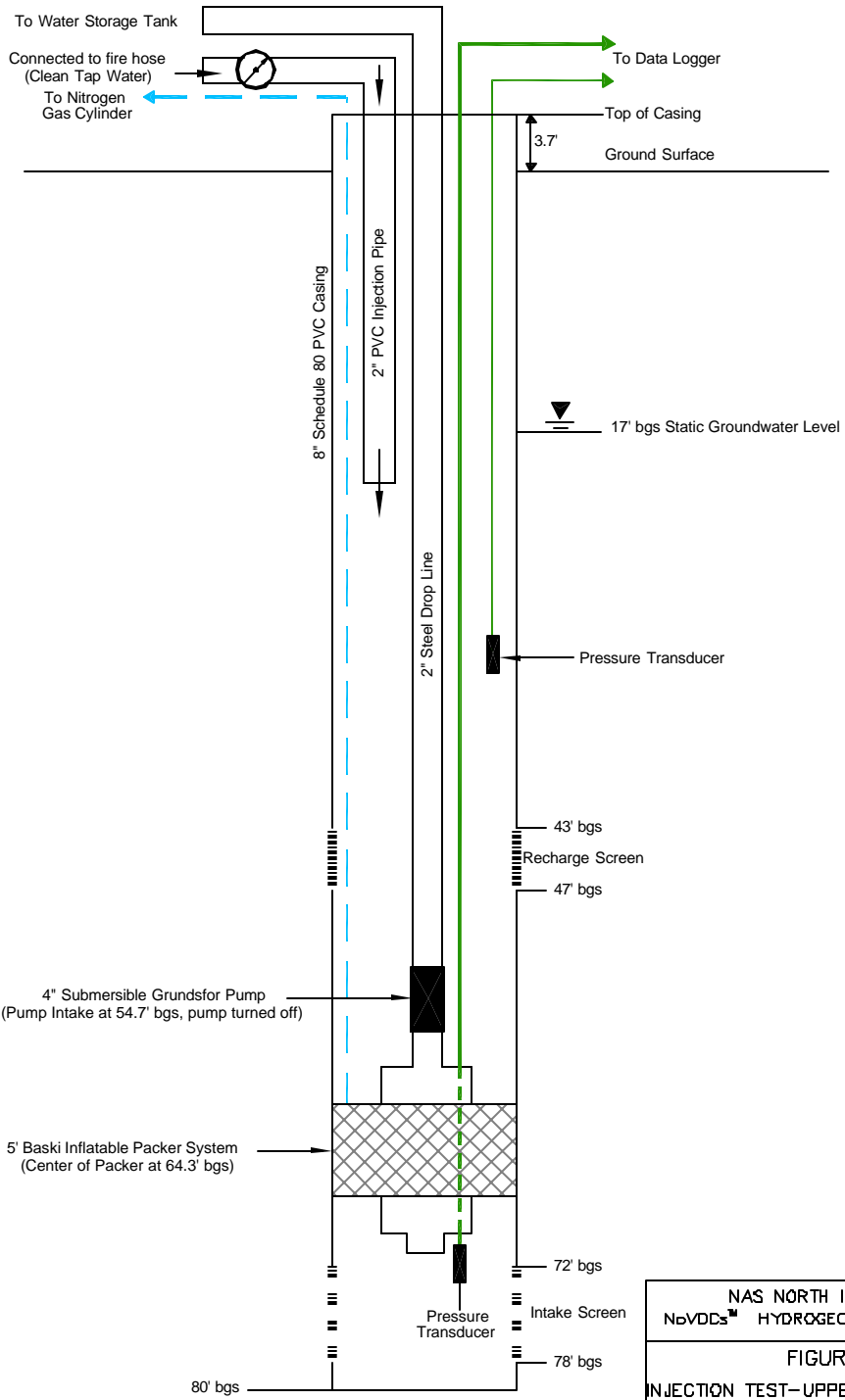

Vertical Scale: 1"=10'

NAS NORTH ISLAND SITE 9
 N6VDCs™ HYDROGEOLOGICAL INVESTIGATION

FIGURE 4-3
 INJECTION TEST-UPPER SCREENED INTERVAL
 INJECTION WELL CONFIGURATION

Tetra Tech EM Inc.

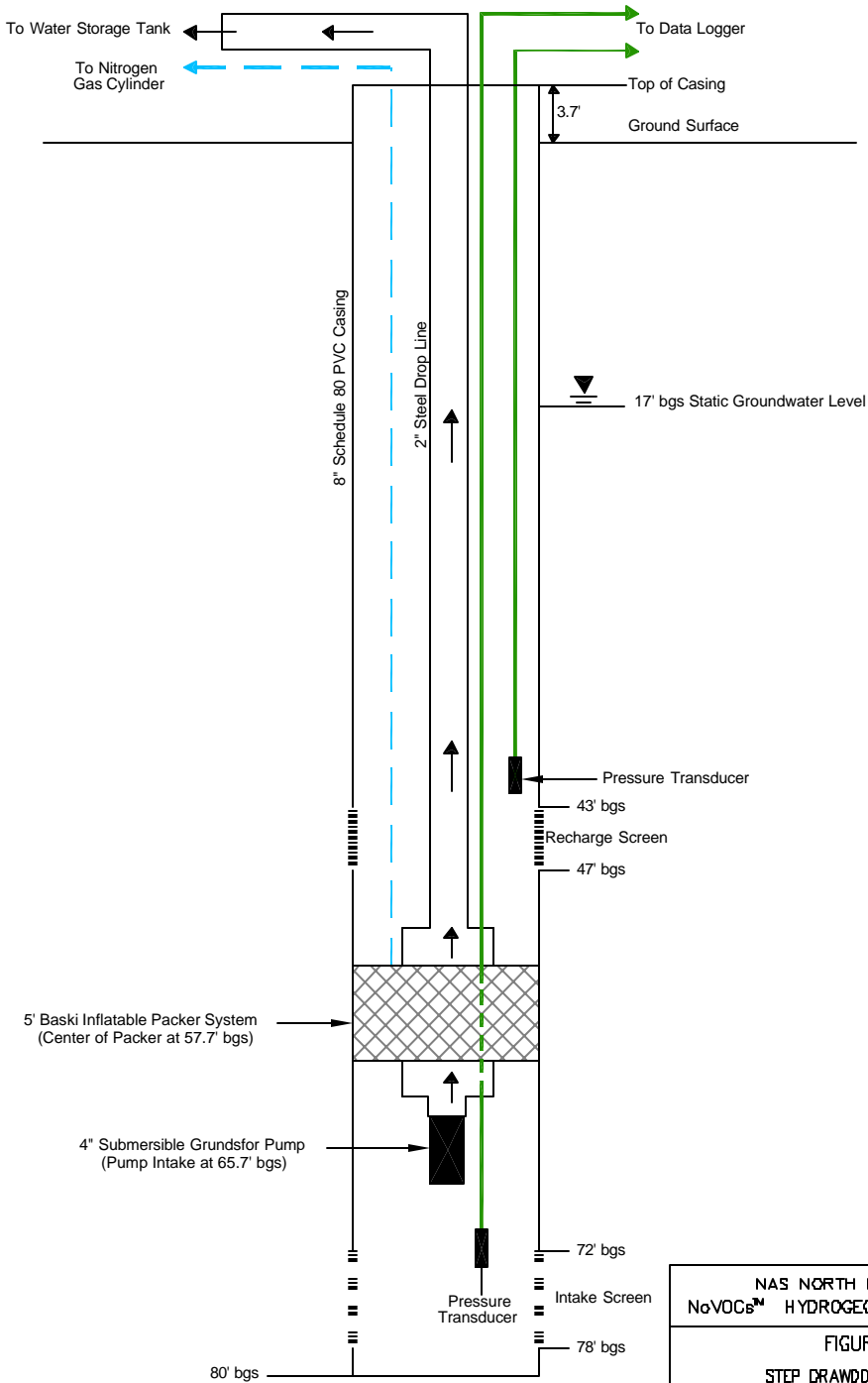

Vertical Scale: 1"=10'

NAS NORTH ISLAND SITE 9
 NgVOCsSM HYDROGEOLOGICAL INVESTIGATION

FIGURE 4-4
 STEP DRAWDOWN TEST-LOWER
 SCREENED INTERVAL PUMPING WELL CONFIGURATION

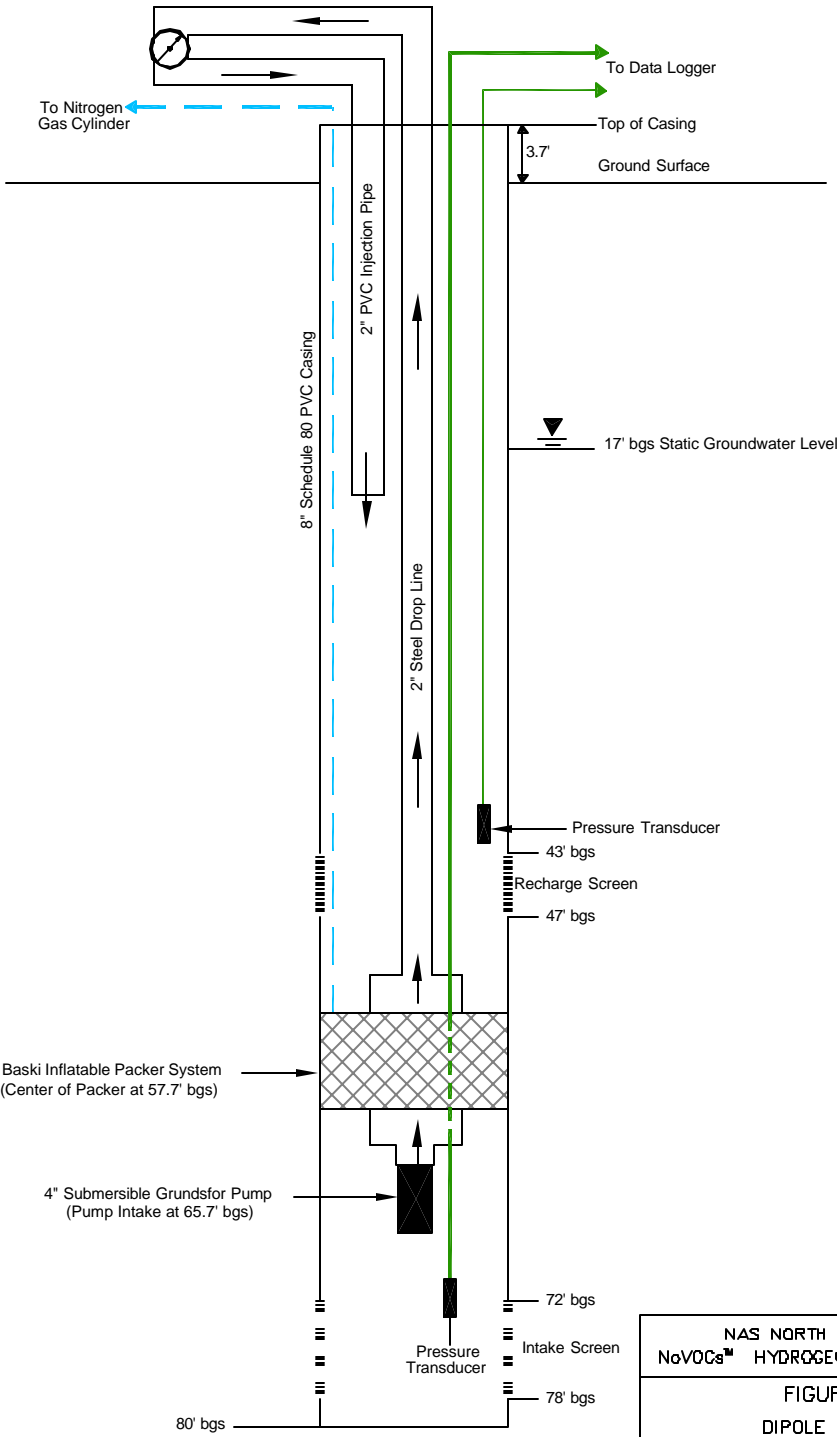

Vertical Scale: 1"=10'

<p>NAS NORTH ISLAND SITE 9 NgVOCs™ HYDROGEOLOGICAL INVESTIGATION</p>
<p>FIGURE 4-5 DIPOLE FLOW TEST WELL CONFIGURATION</p>
<p> Tetra Tech EM Inc.</p>

TABLE 4-1

**TEST EXECUTION SUMMARY
STEP DRAWDOWN TEST UPPER SCREEN INTERVAL
JULY 27, 1998
NoVOCs™ HYDROGEOLOGICAL INVESTIGATION
NAS NORTH ISLAND**

Step	Pumping Rate	Time	Comments
0	NA	14:22	Static groundwater elevation at 17.35 feet below ground surface in the upper screened portion of the NoVOCs™ well
1	43 gpm	14:30 to 14:47	Water level reached pump intake, a water level decrease of about 37 feet in the upper screened portion of the NoVOCs™ well
Recovery	NA	14:47 to 16:00	Pump shut off; aquifer recovery monitored. Transducer lowered about 5 feet at 15:40.
2	10 gpm	16:00 to 16:11	Water level in well decreased 5.9 feet from initial level in upper screened portion of the NoVOCs™ well
Recovery	NA	16:11 to 16:30	Pump shut off (circuit breaker problem); aquifer recovery monitored.
3	15 gpm	16:30 to 17:15	Water level decreased about 11.0 feet from initial level in the upper screened portion of the NoVOCs™ well
4	20 gpm	17:15 to 18:00	Water level decreased about 14.2 feet from initial level in the upper screened portion of the NoVOCs™ well
Recovery	NA	18:00 to 18:42	Pump shut off; aquifer recovery monitored

Notes:

NA Not applicable
gpm Gallons per minute

TABLE 4-2

**TEST EXECUTION SUMMARY
CONSTANT DISCHARGE PUMPING TEST UPPER SCREEN INTERVAL
JULY 28 THROUGH 30, 1998
NoVOCs™ HYDROGEOLOGICAL INVESTIGATION
NAS NORTH ISLAND**

Step	Pumping Rate	Time	Comments
0	NA	07:54 (7/28)	Initial groundwater elevation at 17.79 feet below ground surface in the upper screened portion of the NoVOCs™ well
1	20 gpm	08:00 (7/28) to 16:00 (7/29)	A total drawdown of 16.4 feet observed in the upper screened portion of the NoVOCs™ well
Recovery	NA	16:00 (7/29) to 14:00 (7/30)	Pump shut off; aquifer recovery monitored

Notes:

gpm Gallons per minute
NA Not applicable

TABLE 4-3

**TEST EXECUTION SUMMARY
INJECTION TEST UPPER SCREEN INTERVAL
JULY 31 AND AUGUST 1, 1998
NoVOCs™ HYDROGEOLOGICAL INVESTIGATION
NAS NORTH ISLAND**

Step	Injection Rate	Time	Comments
0	NA	14:55 (7/31)	Initial groundwater elevation at 17.47 feet below ground surface.
1	5 gpm	15:00 to 16:00	Water level in well increased 3.3 feet from initial level in upper screened portion of the NoVOCs™ well
2	15 gpm	16:00 to 17:00	Water level increased about 6.0 feet from Step 1 in the upper screened portion of the NoVOCs™ well
3	22 gpm	17:00 to 18:00	Water level increased about 5.1 feet from Step 2 in the upper screened portion of the NoVOCs™ well
4	30 gpm	18:00 to 18:04	Water level increased about 3.6 feet from Step 3 (water discharging at ground surface through piezometer)
5	25 gpm	18:04 to 18:18	Water level increased about 2.5 feet from Step 3 in the upper screened portion of the NoVOCs™ well
Recovery	NA	18:18 (7/31) to 08:15 (8/1)	Aquifer recovery data collected

Notes:

gpm Gallons per minute
NA Not applicable

TABLE 4-4

**TEST EXECUTION SUMMARY
STEP DRAWDOWN TEST LOWER SCREEN INTERVAL
AUGUST 1 AND 2, 1998
NoVOCs™HYDROGEOLOGICAL INVESTIGATION
NAS NORTH ISLAND**

Step	Pumping Rate	Time	Comments
0	NA	12:19 (8/1)	Initial groundwater elevation at 17.19 feet below ground surface in the upper screened portion of the NoVOCs™well
1a	40 gpm	12:30 to 12:40	Checking integrity of packer seal. Water decreased 11.4 feet from static in lower screened portion of the NoVOCs™well. Packer seal leaking.
Recovery	NA	12:40 to 13:00	Packer deflated and reinflated
1b	50 gpm	13:00 to 14:00	Recheck packer seal integrity. Packer seal integrity OK. Water level in well decreased 15.1 feet from initial level in lower screened portion of the NoVOCs™well
2	64 gpm	14:00 to 15:00	Water level decreased about 20.8 feet from initial level in the lower screened portion of the NoVOCs™well.
Recovery	NA	15:00 to 15:30	Pump shut off; aquifer recovery monitored
3	30 gpm	15:30 to 16:30	Water level decreased about 9.6 feet from initial level in the lower screened portion of the NoVOCs™well
Recovery	NA	16:30 (8/1) to 0730 (8/4)	Pump shut off; aquifer recovery monitored

Notes:

gpm Gallons per minute
NA Not applicable

TABLE 4-5

**TEST EXECUTION SUMMARY
DIPOLE FLOW TEST
AUGUST 5 THROUGH 7, 1998
NoVOCs™HYDROGEOLOGICAL INVESTIGATION
NAS NORTH ISLAND**

Step	Injection Rate	Time	Comments
0	NA	11:29 (8/5)	Initial groundwater elevation at 20.69 feet in upper section of the NoVOCs™well
1	5 to 6 gpm	11:35 to 12:29	Water level increased about 5.3 feet from initial water level in the upper screened section of the NoVOCs™well. Water level decreased about 2.2 feet from static water level in lower screened section of the NoVOCs™well.
2	10 gpm	12:29 to 13:40	Water level increased about 3.3 feet from Step 1 water level in the upper screened section of the NoVOCs™well. Water level decreased about 1.5 feet from Step 1 in the lower screened section of the NoVOCs™well.
3	15 gpm	13:40 to 14:41	Water level increased about 2.8 feet from Step 2 water level in the upper screened section of the NoVOCs™well. Water level decreased about 1.0 foot from Step 2 in the lower screened section of the NoVOCs™well.
4	20 gpm	14:41 to 15:47	Water level increased about 3.8 feet from Step 3 water level in the upper screened section of the NoVOCs™well. Water level decreased about 1.8 feet from Step 3 in the lower screened section of the NoVOCs™well.
5	24 to 25 gpm	15:47 to 16:41	Water level increased about 2.3 feet from Step 4 water level in the upper screened section of the NoVOCs™well. Water level decreased about 1.3 feet from Step 4 in the lower screened section of the NoVOCs™well.
Recovery	NA	16:41 (8/5) to 09:45 (8/7)	Aquifer recovery data collected

Notes:

gpm Gallons per minute
NA Not applicable

TABLE 4-6

**WATER QUALITY PARAMETERS
AQUIFER PUMPING TESTS
NoVOCs™ HYDROGEOLOGICAL INVESTIGATION
NAS NORTH ISLAND**

Page 1 of 2

Date	Time	Temperature (°C)	Specific Conductance (µmhos)	pH	Eh (mv)	Dissolved Oxygen (mg/L)	Salinity (percent)	Turbidity (NTU)
Step Drawdown Test - Upper Screen Interval								
7/22/98	13:25	22	29.7	6.87	32	8.46	2.64	1
7/22/98	13:30	21.8	27.8	7.01	-40	8.48	2.67	53
7/22/98	13:35	22.0	27.3	7.08	-20	8.65	2.68	53
7/22/98	13:40	22.0	27.1	7.12	-29	8.63	2.59	53
7/22/98	--	21.5	27.9	7.17	-89	8.88	2.59	53
7/22/98	15:12	22.2	26.9	7.12	-11	8.72	2.67	1
7/22/98	15:24	21.3	26.9	7.09	-13	8.93	2.68	NM
Average		21.82	27.7	7.07	-24	8.68	2.65	36
Constant Rate Pump Test - Upper Screen Interval								
7/27/98	20:20	21.7	23.5	7.03	15	7.76	2.48	67
7/27/98	21:32	21.6	24.4	7.35	42	7.40	2.51	63
7/28/98	08:06	21.5	24.7	7.24	84	7.39	2.47	3
7/28/98	08:17	21.6	24.8	7.21	66	NM	NM	NM
7/28/98	10:23	22.5	24.7	7.33	59	8.44	2.44	60
7/28/98	11:20	22.0	24.5	7.37	30	8.64	2.43	55
7/28/98	12:23	22.0	24.6	7.39	31	8.64	2.43	61
7/28/98	14:26	22.1	23.9	7.39	67	8.54	2.38	54
7/28/98	15:30	21.8	23.6	7.42	18	8.64	2.38	3
7/28/98	16:36	22.5	23.3	7.41	41	9.62	2.34	3
7/28/98	17:33	21.8	23.2	7.43	37	8.54	2.31	50
7/28/98	19:57	21.6	22.8	7.44	31	7.58	2.25	3
7/28/98	21:14	21.5	22.5	7.45	-1	7.46	2.25	0
7/28/98	22:18	21.6	22.3	7.46	-9	7.43	2.22	0
7/28/98	23:09	21.4	22.2	7.47	-14	7.39	2.21	2
7/29/98	00:18	21.6	22.0	7.44	-15	7.33	2.19	0
7/29/98	01:15	21.6	21.7	7.43	-13	7.21	2.19	2
7/29/98	02:17	21.6	23.0	7.43	-7	7.30	2.18	4
7/29/98	03:15	21.6	23.2	7.43	-8	7.56	2.14	3
7/29/98	04:24	21.6	22.8	7.41	-7	7.62	2.13	2
7/29/98	05:19	21.6	23.0	7.44	-16	7.51	2.14	1
7/29/98	06:12	21.6	23.1	7.45	-9	7.56	2.16	5
7/29/98	07:00	21.3	18.7	7.47	-4	7.64	2.15	9
7/29/98	10:25	21.7	23.7	7.48	51	7.92	2.11	1
7/29/98	12:30	22.0	23.1	7.50	49	8.27	2.09	3
7/29/98	14:30	27.4	20.0	7.44	45	8.49	2.09	0
7/29/98	15:54	21.8	22.6	7.49	49	8.38	2.04	2
Average		21.95	23.03	7.40	22.67	7.93	2.26	17.54

**WATER QUALITY PARAMETERS
AQUIFER PUMPING TESTS
NoVOCs™ HYDROGEOLOGICAL INVESTIGATION
NAS NORTH ISLAND
Page 2 of 2**

Date	Time	Temperature (°C)	Specific Conductance (μ mhos)	pH	Eh (mv)	Dissolved Oxygen (mg/L)	Salinity (percent)	Turbidity (NTU)
Step Drawdown Test - Lower Screen Interval								
8/1/98	13:34	21.8	24.2	6.97	-14	8.46	2.70	53
8/1/98	14:13	21.7	27.0	7.02	-31	8.37	2.70	2
8/1/98	14:30	21.7	27.0	7.11	-32	8.05	2.71	0
8/1/98	14:52	21.7	27.8	7.06	-32	8.35	2.72	62
8/1/98	15:46	21.9	29.0	7.02	-36	8.33	2.71	3
8/1/98	16:16	21.7	29.4	7.01	-38	8.06	2.72	6
Average		21.8	27.4	7.03	-31	8.27	2.71	21

Notes:

° C	Degrees Celsius.
μ mhos	Micromhos
mv	Millivolts
mg/L	Milligrams per liter
NTU	Nephelometric turbidity units
NM	Not measured
Eh	Reduction/oxidation potential

5.0 DATA INTERPRETATION

This section interprets and discusses the data collected during the aquifer tests and the tidal influence study, including groundwater tidal influence correction for the pumping test data, calculations of well-specific yield and efficiency, calculations of aquifer hydraulic parameters, calculations of the mean groundwater levels, calculations of fresh water equivalent heads (density correction) and estimation of groundwater flow patterns.

5.1 TIDAL INFLUENCE CORRECTION

Groundwater levels in the vicinity of the NoVOCs™ well are affected by tidal fluctuations in San Diego Bay because of hydraulic communication between the groundwater and the bay and the proximity of the site to the bay. Water level data derived from pumping tests must be corrected for tidal influence before they can be used to estimate aquifer parameters, except when the water level fluctuation caused by tides is insignificant in comparison with drawdown (such as in the pumping well). This section discusses the principles of and approaches to the tidal influence correction, and applies the corrections to the pumping test water level data.

5.1.1 Relationship Between Tide and Groundwater Fluctuation

Observed groundwater level fluctuations can be divided into two components: (1) tidally induced fluctuations, and (2) fluctuations caused by other factors. This relationship can be described by the following equation:

$$\frac{dh'(t)}{dt} = \frac{dh(t)}{dt} - E_{tide} \frac{dH(t-t_{lag})}{dt} \quad (5-1)$$

where

h_0	=	Groundwater elevations without tidal influence [L]
h	=	Observed groundwater elevation [L]
H	=	Tidal elevation in surface water body [L]
E_{tide}	=	Tidal efficiency [dimensionless]

t	=	The time when groundwater elevation was measured [T]
t _{lag}	=	Time lag between tidal effects in surface water body and corresponding effects at groundwater observation points [T]

The first term of the right-hand side of Equation 5-1 represents the observed groundwater level fluctuation, and the second term of the right-hand side represents tidally induced groundwater level fluctuation. The left-hand side of the equation represents groundwater fluctuations caused by other factors, such as pumping of groundwater, lateral changes in recharge or discharge in the aquifer, and other daily and seasonal water level changes (such as those caused by barometric pressure changes).

As shown in Equation 5-1, the relationship between the tidal fluctuation in the surface water levels and the tidally induced groundwater level fluctuation is determined by two parameters: tidal efficiency (E_{tide}), and time lag (t_{lag}). The tidal efficiency is defined as the ratio of tidally induced changes in groundwater levels to the tidal changes in the surface water body. The time lag represents the time difference between the tidal changes in the surface water body and corresponding changes in groundwater levels. Both the tidal efficiency and time lag are determined by a number of factors, including aquifer hydraulic conductivity and storativity (or diffusivity), aquifer thickness, and distance from the observation well to the surface water body. The relationship between the tidal influence parameters and the above factors in a homogeneous and isotropic aquifer can be expressed as follows (Jacob 1950; Ferris 1951):

$$E_{tide} = e^{\left(-x\sqrt{\frac{pS}{t_pKB}}\right)} \quad (5-2)$$

and

$$t_{lag} = x\sqrt{\frac{t_p S}{4pKB}} \quad (5-3)$$

where

x	=	Distance from the observation well to the coast line [L]
S	=	Aquifer storativity [dimensionless]
K	=	Aquifer hydraulic conductivity [LT^{-1}]
B	=	Aquifer thickness (L)
t _p	=	Tidal period (time between consecutive high and low tides) [T]

Based on Equations 5-2 and 5-3, the tidal efficiency will increase as aquifer hydraulic conductivity and aquifer thickness increase, and decrease as aquifer storativity and the distance from the coast increase. The tidal time lag will decrease as aquifer hydraulic conductivity and aquifer thickness increase, and increase as aquifer storativity and the distance from the coast increase. Based on these relationships, the time lag will generally decrease when tidal efficiency increases. Theoretically, the tidal efficiency and time lag are not functions of time.

Equations 5-2 and 5-3 are based on the following assumptions:

- Tidal fluctuations can be described as a sinusoidal function
- One-dimensional groundwater flow is perpendicular to the shoreline
- The aquifer is homogeneous and isotropic
- The aquifer is under confined conditions
- The shoreline is considered a lateral boundary that is perpendicular to groundwater flow direction
- The observation well fully penetrates the aquifer

In reality, aquifer conditions rarely meet all the above assumptions (Erskine 1991; Serfes 1991). Consequently, tidal efficiency and time lag are generally not calculated from Equations 5-2 and 5-3; the equations have been presented to provide a theoretical definition of tidal efficiency and time lag. Instead, these two parameters are usually determined directly from observed groundwater and surface water level fluctuations. A procedure to calculate tidal efficiency and time lag from the observed groundwater and tidal data is presented in the following section.

5.1.2 Procedure for Calculating Tidal Efficiency and Time Lag

In order to calculate the tidal efficiency and time lag from the observed surface water (San Diego Bay) and groundwater level data, an observation period should be selected during which the groundwater level fluctuations are primarily affected by tide; other factors affecting groundwater levels (such as rainfall infiltration and pumping) should be negligible. From Equation 5-1, if the effects of factors other than tidal fluctuations can be ignored ($dh' / dt = 0$), the observed groundwater fluctuations can be used directly to represent the tidally induced fluctuations, as expressed by the following equation:

$$\frac{dh(t)}{dt} = E_{tide} \frac{dH(t-t_{lag})}{dt} \quad (5-4)$$

For a time period from t_0 to t_1 in the groundwater observation record, the solution of Equation 5-4 can be obtained by integration as follows:

$$\int_{t_0}^{t_1} \frac{dh(t)}{dt} dt = \int_{t_0}^{t_1} E_{tide} \frac{dH(t-t_{lag})}{dt} dt \quad (5-5)$$

This integral can be expressed as follows:

$$h(t_1) - h(t_0) = E_{tide} [H(t_1 - t_{lag}) - H(t_0 - t_{lag})] \quad (5-6)$$

Based on Equation 5-6, the tidal efficiency can be calculated as follows:

$$E_{tide} = \frac{h(t_1) - h(t_0)}{H(t_1 - t_{lag}) - H(t_0 - t_{lag})} \quad (5-7)$$

Equation 5-7 represents the tidal efficiency for the period from t_0 to t_1 .

In principle, tidal efficiency and time lag are constants that do not vary with time. However, these parameters may vary from time to time because of groundwater flow conditions and inconsistencies in the amplitude and periodicity of tidal fluctuations. In general, various tidal efficiencies can be calculated using Equation 5-7 for different periods of the data. Different time lags can also be determined independently using different data sets. A procedure for calculation of tidal efficiency and time lag is described as follows:

- (1) Choose a period in the observed groundwater level record when groundwater fluctuations are almost exclusively caused by the tidal fluctuations.
- (2) Identify the high tide and low tide in tidal records, and identify corresponding groundwater high level and low level in groundwater level records.
- (3) Calculate tidal time lag as follows:

$$t_{lag} = t_{i(tide)} - t_{i(gw)} \quad (5-8)$$

where

- $t_{i(tide)}$ = Time for the i^{th} high (or low) tide [T]
 $t_{i(gw)}$ = Elevation time for the i^{th} high (or low) groundwater elevation corresponding to the i^{th} high (or low) tide [T]

(4) Calculate the tidal efficiency using the following equation:

$$E_{tide} = \frac{h_i - h_{i-1}}{H_i - H_{i-1}} \quad (5-9)$$

where

- H_i = The i^{th} high (or low) tidal elevation (L)
 h_i = The i^{th} high (or low) groundwater elevation corresponding to the i^{th} high (or low) tide [T]

Figure 5-1 presents a graphical illustration of the time lag and tidal efficiency (amplitudes of the tidal fluctuations in San Diego Bay and MW-45) based on a comparison of San Diego Bay water levels and groundwater levels in observation well MW-45.

5.1.3 Calculation of Tidal Efficiency and Time Lag Using April 1998 Tidal Study Data

Tidal efficiency and time lags were calculated based on the groundwater elevation data collected at eight observation wells during the April 1998 tidal influence study. The groundwater elevations in the wells were recorded at 10-minute intervals for 10 days. During this period, the surface water level data in San Diego Bay can be divided into 39 monotonic segments (that is, water levels from high to low or low to high tide). Groundwater levels at all observation wells clearly showed tidally influenced fluctuations that correspond to the tidal fluctuations in San Diego Bay. The average amplitude of tides in the bay for the 10-day period was 5.27 feet, and the average amplitude of groundwater fluctuations in various observation wells ranged from 0.36 to 0.46 feet. The maximum, minimum, and mean tidal amplitude and groundwater fluctuations are presented in Table 5-1.

The tidal efficiency and time lags were calculated for each of the 39 monotonic tidal segments during the 10-day tidal study using the procedure described in section 5.1.2. Table 5-1 shows the maximum, minimum, and mean estimated tidal efficiencies and time lags for the eight observation wells at the site.

As shown in the table, both the tidal efficiency and time lag vary slightly at the various observation well locations, but vary significantly during different tidal cycles, as indicated by the significant difference between minimum and maximum values of tidal efficiency and time lag. The mean tidal efficiency (average tidal efficiency for all 39 tidal periods) at the eight observation wells ranges from 0.07 to 0.09. The higher tidal efficiency values were measured at downgradient observation wells (MW-52 and MW-53), which are the closest to the bay of the wells monitored. The difference between the maximum and minimum tidal efficiency during different tidal cycles was about 0.03 for most of the wells.

The mean time lags (average time lag for all 39 monotonic tidal periods) did not change significantly from well to well, ranging from 69 minutes to 72 minutes. However, the time lags in each well changed considerably during different tidal cycles (Table 5-1).

5.1.4 Procedures for Tidal Correction of Groundwater Drawdown Data

When an aquifer hydraulic test is conducted in a tidally influenced aquifer, groundwater levels are affected by at least two major factors: drawdown from pumping and fluctuation caused by tide. Tidal fluctuation, if significant compared with pumping drawdown, can complicate interpretation of test data. Literature review shows that correction of non-steady state pumping test data for tidal influence has not been much studied and that no readily applicable methods are currently available. Therefore, in this section, two different approaches are developed and discussed. The two approaches? that is, the tidal correction of the drawdown data collected during the upper aquifer zone constant discharge pumping test? are presented in this section.

5.1.4.1 Approach Based on the Linear Relationship Between Groundwater and Tide

As shown in Equation 5-1, observed groundwater level fluctuations in tidally influenced aquifers are the sum of tidally induced fluctuations and water level changes caused by other factors. For the time period from t_0 to t , differential Equation 5-1 can be solved by integration, as follows:

$$\int_{t_0}^t \frac{dh'}{dt} dt = \int_{t_0}^t \frac{dh}{dt} dt - \int_{t_0}^t E_{tide} \frac{dH(t - t_{lag})}{dt} dt \quad (5-10)$$

This integral can be expressed as follows:

$$h'(t) = h(t) - h(t_0) - E_{\text{tide}} [H(t - t_{\text{lag}}) - H(t_0 - t_{\text{lag}})] + h'(t_0) \quad (5-11)$$

where

$h(t)$	=	Tidally corrected groundwater elevation at time t [L]
$h(t_0)$	=	Tidally corrected groundwater elevation at initial time t_0 [L]
$h(t)$	=	Observed groundwater elevation at time t [L]
$h(t_0)$	=	Observed groundwater elevation at initial time t_0 [L]
$H(t - t_{\text{lag}})$	=	Tidal elevation at time $t - t_{\text{lag}}$ [L]
$H(t_0 - t_{\text{lag}})$	=	Tidal elevation at time $t_0 - t_{\text{lag}}$ [L]
E_{tide}	=	Tidal efficiency [dimensionless]
t_{lag}	=	Time lag [T]

This equation shows that the groundwater elevations corrected for tidal influence can be calculated from the observed groundwater elevations, observed tidal elevations, and tidal influence parameters (tidal efficiency and time lag). The equation also shows that the tidal influence component of changes in groundwater level can be expressed as a linear function of tidal fluctuations in surface water.

Water level drawdowns at time t can be defined as:

$$s(t) = h_{\text{ref}} - h(t) \quad (5-12)$$

and

$$s'(t) = h_{\text{ref}} - h'(t) \quad (5-13)$$

where

h_{ref}	=	Reference groundwater level (a constant) [L]
$s(t)$	=	Observed water level drawdown at time t [L]
$s(t)$	=	Tidally corrected water level drawdown at time t [L]

Using Equations 5-12 and 5-13 to substitute for $h(t)$, $h(t_0)$, $h'(t)$, and $h'(t_0)$ in Equation 5-11, the tidally corrected water level drawdown can be described as follows:

$$s'(t) = s(t) - s(t_0) - E_{tide} [H(t_0 - t_{lag}) - H(t - t_{lag})] + s'(t_0) \quad (5-14)$$

where

- $s(t_0)$ = Observed water level drawdown at initial time t_0 [L]
 $s'(t_0)$ = Tidally corrected water level drawdown at time t_0 [L]

Both Equations 5-11 and 5-14 assume that the tidal efficiency and time lag are constant over the calculation period from t_0 to t . However, as discussed in the previous section, tidal efficiency and time lag are generally not constant for different tidal periods (tidal cycles). In fact, tidal study data collected in April 1998 at the site demonstrate that tidal efficiency and time lag vary significantly over the 10-day period.

Equations 5-11 and 5-14 are the basis of the first approach (linear relationship) used for tidal correction of the groundwater drawdown data. The tide data were obtained from the San Diego Bay station of the National Oceanic and Atmospheric Administration (NOAA). The linear relationship approach for correcting groundwater drawdown data for tidal influence is described as follows:

- (1) Identify the high and low points in the bay tide elevation record, and divide the bay tide record into monotonic segments bounded by consecutive high and low tide elevations.
- (2) Identify the high and low groundwater levels in the groundwater drawdown data, and divide the groundwater drawdown data into segments that correspond to the monotonic tidal segments identified in step 1.
- (3) Compare each of the bay tidal segments with corresponding groundwater drawdown data segments to determine whether the time spans are similar for the two segments. If the time span for a monotonic tidal segment is different from the corresponding drawdown segment, the time scale of the tidal segment is compressed or expanded by linear interpolation to match the drawdown segment.
- (4) The first and last groundwater drawdown segments may or may not match a complete monotonic segment of the bay tide, depending on timing of the pumping test in relation to the tide cycles. Therefore, multiple smaller data segments are used to better match the time scale of the early pumping test data.
- (5) Shift the time axis of the bay tidal segments based on the range of the time lag values calculated from the April 1998 tidal study data (Table 5-1). Apply the tidal efficiency

(also Table 5-1) to correct each segment of observed groundwater drawdown using the equation:

$$s'(\mathbf{t}) = s(\mathbf{t}) - s(0) - E[H(0)_0 - H(\mathbf{t})] + s'(0) \quad (5-15)$$

where

$s(\tau)$	=	Corrected groundwater drawdown for the segment [L]
$s(0)$	=	Corrected groundwater drawdown at the start of the segment [L]
$s(\tau)$	=	Observed groundwater drawdown for the segment [L]
$s(0)$	=	Observed groundwater drawdown at the start of the segment [L]
$H(\tau)$	=	Tidal elevation for the segment [L]
$H(0)$	=	Tidal elevation at the start of the segment [L]
E	=	Tidal efficiency for the segment [dimensionless]
τ	=	Time since beginning of the segment [T]

- (6) The tidal correction procedure is repeated for all segments of the tidal and groundwater drawdown record.

5.1.4.2 Approach Based on the Best-Fit Equation of Groundwater Tidal Fluctuation

In the second approach for tidal correction of groundwater drawdown data, a tidal influence curve (best-fit equation) is generated for the period of the pumping test that reflects only tidal fluctuations. These tidal influence curves are generated for data from each of the observation wells. Using this approach, fluctuations in groundwater levels calculated from the tidal influence curve are subtracted from the observed drawdown data collected during the pumping test. The corrected drawdown can then be used to calculate aquifer parameters.

The tidal influence curves for observation wells within the radius of influence during a pumping test can be derived from the tidal influence curves for data from wells outside the radius of influence or from tidal curves for the bay tide. Tidal data collected at the observation wells before or after the pumping test cannot be used because the bay tide changes significantly with time. During the pumping test, tidal fluctuation at different wells within the pumping aquifer is generally a function of aquifer hydraulic properties and distance from the shoreline but not a function of time, as described in Equations 5-2 and 5-3.

In general, the tidal influence curve at a monitoring well is described as a series of sinusoidal (or cosine) functions as follows:

$$f(t) = A + \sum_{i=1}^n B_i \sin\left[\frac{2\pi}{T_i}(t + \tau_i)\right] \quad (5-16)$$

where

- A = A constant related to the difference between groundwater and bay tide elevations [L]
- B_i = The amplitude of the *i*th tidal constituent [L]
- T_i = The period of the *i*th tidal constituent [T]
- τ_i = The phase of the *i*th tidal constituent [T]

The amplitude, period, and phase of the tidal function in groundwater are related to the tidal efficiency and time lag of the aquifer and the same parameters of the bay tidal constituents. The bay tidal constituents in turn are caused by the rotation of the Earth about the sun, the moon about the Earth, and the Earth on its axis. The amplitude, period, and phase of each tidal constituents (waves) of the tidal influence function can be calculated through harmonic analysis, which is commonly used to predict ocean tides at various locations in the United States. The phase of the ocean tide is determined by the starting point of the prediction, and the phase of groundwater tidal influence is a function of the starting point of the calculation and time lag behind the ocean tide.

Groundwater level at well MW-20 was observed using a pressure transducer during the entire period of the aquifer test (including step drawdown and constant discharge pumping tests). Well MW-20 is located approximately 800 feet from the NoVOCs™ pumping well and about 140 feet from San Diego Bay. This well is clearly outside the radius of pumping influence. Therefore, the second approach (best-fit equation) was developed using groundwater level data for well MW-20.

The tidal correction procedures for the pumping test drawdown data based on the best-fit equation approach is described as follows:

- (1) Plot the groundwater level data collected from well MW-20. Based on Equation 5-16, a best-fit tidal curve (as a sinusoidal equation) can be obtained through harmonic analysis. The plot and best-fit tidal curve are presented in Figure 5-2. The correlation coefficient

(R^2) of the best-fit equation (tidal curve) is 0.96. The tidal curve for MW-20 is described as:

$$f_{MW-20}(t) = 3.60 + 0.21 \sin\left(\frac{2p}{25.76}t\right) + 0.51 \sin\left[\frac{2p}{23.78}(t - 1.72)\right] \\ + 0.69 \sin\left[\frac{2p}{12.36}(t - 6.87)\right] + 0.29 \sin\left[\frac{2p}{11.89}(t - 8.92)\right] \quad (5-17)$$

- (2) Select a time period when the pumping impact is insignificant (from August 1 through 4, 1998, after the deep aquifer zone step drawdown tests), and compare data for well MW-20 with the bay tide and groundwater level data collected from other observation wells (Figures 5-3 through 5-10)
- (3) Based on Equation 5-17 and Figure 5-3, generate the tidal influence curve for well MW-45: the elevation constant (A) is calculated
- (4) Based on the difference between the average groundwater elevations in wells MW-20 and MW-45; the amplitude constants (B_i) are calculated based on the difference in tidal efficiency between the two wells; the tidal period constants (T_i) are kept the same; and phase constants (τ_i) are adjusted based on the starting time and the different time lags between the two wells. The tidal influence curve for well MW-45 during the period of the constant discharge pumping test is described as follows:

$$f_{MW-45}(t) = 5.00 + 0.057 \sin\left[\frac{2p}{25.76}(t + 0.79)\right] + 0.12 \sin\left[\frac{2p}{23.78}(t - 0.05)\right] \\ + 0.29 \sin\left[\frac{2p}{12.36}(t - 7.94)\right] + 0.15 \sin\left[\frac{2p}{11.89}(t - 8.11)\right] \quad (5-18)$$

- (5) Repeat Steps 3 and 4 to obtain the tidal influence curves for data from wells MW-46, MW-47, MW-48, MW-49, MW-52, MW-53, and MW-54. Equation 5-17 and Figures 5-3 through 5-10 are used for determining the tidal influence functions. The tidal influence curves for these wells during the constant discharge pumping test are described by the following equations:

$$f_{MW-46}(t) = 4.77 + 0.05 \sin\left[\frac{2p}{25.76}(t + 0.31)\right] + 0.14 \sin\left[\frac{2p}{23.78}(t - 1.42)\right] \\ + 0.26 \sin\left[\frac{2p}{12.36}(t - 8.13)\right] + 0.16 \sin\left[\frac{2p}{11.89}(t - 8.32)\right] \quad (5-19)$$

$$\begin{aligned}
f_{MW-47}(t) = & 4.51 + 0.06 \sin\left[\frac{2p}{25.76}(t + 2.95)\right] + 0.142 \sin\left[\frac{2p}{23.78}(t + 0.63)\right] \\
& + 0.283 \sin\left[\frac{2p}{12.36}(t - 7.78)\right] + 0.163 \sin\left[\frac{2p}{11.89}(t - 7.66)\right]
\end{aligned} \tag{5-20}$$

$$\begin{aligned}
f_{MW-48}(t) = & 4.71 + 0.12 \sin\left[\frac{2p}{25.76}(t + 1.63)\right] + 0.163 \sin\left[\frac{2p}{23.78}(t + 0.55)\right] \\
& + 0.26 \sin\left[\frac{2p}{12.36}(t - 8.60)\right] + 0.19 \sin\left[\frac{2p}{11.89}(t - 9.15)\right]
\end{aligned} \tag{5-21}$$

$$\begin{aligned}
f_{MW-49}(t) = & 4.51 + 0.02 \sin\left[\frac{2p}{25.76}(t + 0.30)\right] + 0.06 \sin\left[\frac{2p}{23.78}(t - 0.78)\right] \\
& + 0.266 \sin\left[\frac{2p}{12.36}(t - 8.09)\right] + 0.167 \sin\left[\frac{2p}{11.89}(t - 8.38)\right]
\end{aligned} \tag{5-22}$$

$$\begin{aligned}
f_{MW-52}(t) = & 4.76 + 0.02 \sin\left[\frac{2p}{25.76}(t + 1.86)\right] + 0.08 \sin\left[\frac{2p}{23.78}(t - 0.31)\right] \\
& + 0.205 \sin\left[\frac{2p}{12.36}(t - 7.91)\right] + 0.08 \sin\left[\frac{2p}{11.89}(t - 9.14)\right]
\end{aligned} \tag{5-23}$$

$$\begin{aligned}
f_{MW-53}(t) = & 4.49 + 0.02 \sin\left[\frac{2p}{25.76}(t + 1.86)\right] + 0.14 \sin\left[\frac{2p}{23.78}(t - 1.42)\right] \\
& + 0.26 \sin\left[\frac{2p}{12.36}(t - 8.13)\right] + 0.16 \sin\left[\frac{2p}{11.89}(t - 8.32)\right]
\end{aligned} \tag{5-24}$$

$$\begin{aligned}
f_{MW-54}(t) = & 5.04 + 0.035 \sin\left[\frac{2p}{25.76}(t + 0.31)\right] + 0.103 \sin\left[\frac{2p}{23.78}(t - 1.08)\right] \\
& + 0.275 \sin\left[\frac{2p}{12.36}(t - 8.13)\right] + 0.16 \sin\left[\frac{2p}{11.89}(t - 8.32)\right]
\end{aligned} \tag{5-25}$$

- (6) Calculate tidal fluctuation in groundwater using the above tidal influence equations for data from all observation wells. Subtract the tidal fluctuation from the observed groundwater elevations, and calculate tidally corrected drawdown from the tidally corrected groundwater elevations. Using data for well MW-45 as example, the corrected drawdown is calculated using the following equation:

$$s^*(t) = [h(0) - f_{MW-45}(0)] - [h(t) - f_{MW-45}(t)] \quad (5-26)$$

where

$s^*(t)$	=	Tidally corrected groundwater drawdown [L]
$h(0)$	=	Observed groundwater elevation at the beginning of the pumping test [L]
$h(t)$	=	Observed groundwater elevation during the pumping test [L]
$f_{MW-45}(0)$	=	Calculated groundwater elevation from the tidal influence curve at the beginning of the pumping test [L]
$f_{MW-45}(t)$	=	Calculated groundwater elevation from the tidal influence curve at the beginning of the pumping test [L]

5.1.5 Tidal Influence Correction for the Constant Pumping Test

As shown in Figures D2 through D6 in Appendix D, groundwater level data collected during the constant discharge pumping test in the upper aquifer zone showed significant tidal influence. In order to use the pumping test data to calculate aquifer hydraulic parameters, the observed groundwater drawdown must be corrected for tidal influence. The goal of the tidal influence correction is to separate groundwater drawdown caused by pumping from groundwater fluctuations caused by tidal influence, only the pumping-induced groundwater drawdown is used to calculate aquifer parameters.

Two tidal influence correction approaches are developed and discussed in Section 5.1.4. Both approaches are used to correct the drawdown data collected during the constant discharge pumping test in the upper aquifer zone. The two key tidal influence parameters, tidal efficiency and time lag, are applied in the first approach to derive fluctuations in groundwater caused by tides at the observation wells. The parameter values are initially calculated from the April 1998 tidal study data. Because the bay tide during the pumping test (July/August 1998) was different from the tide in April 1998, the parameters are adjusted to provide the best results of tidal influence correction. Table 5-2 shows the adjusted tidal efficiency and time lags used for the tidal influence correction.

Observed San Diego Bay tide and groundwater levels in well MW-20, the simulated tidal influence (curves), and observed groundwater levels for well MW-45 during the constant discharge pumping test are compared in Figure 5-11. The figure shows that the tidal influence decreased with distance from the bay, and that the simulated tidal influences using the two different approaches are similar.

Figures 5-12 through 5-19 compare the observed and corrected groundwater drawdown data at different observation wells for the constant discharge pumping test. As shown in these figures, the original observed groundwater drawdown graphs indicate significant tidal influence. After correction for tidal influence, the groundwater drawdown curves show typical groundwater level drawdown caused by pumping. The figures also show that the tidal influence corrections using the two different approaches are generally in close agreement. The corrected groundwater drawdown data using the linear relationship approach are applied in Section 5.3 to calculate aquifer parameters.

In summary, two new approaches for tidal correction of groundwater drawdown data collected during a pumping test have been developed. The corrected drawdown data using both approaches correlated reasonably well with each other and reflect typical pumping test responses. Some uncertainties associated with both tidal correction approaches include impact of aquifer heterogeneity, differences in tidal fluctuation during different tidal periods (tidal cycles), and interpolation of tidal data to match frequent data records at the early stage of the pumping test.

5.2 CALCULATION OF SPECIFIC CAPACITY AND WELL EFFICIENCY

This section presents the calculations of specific capacity and well efficiency for the NoVOCs™ well. The calculations are based on water level data collected from the step-drawdown test conducted in the upper screened portion of the well (screened in the upper aquifer zone), the step-drawdown conducted in the lower screened portion (screened in the deep aquifer zone), and the water injection test conducted in the upper screened portion.

5.2.1 Specific Capacity Calculation

Specific capacity of a pumping well is calculated based on (1) the pumping rate and measured maximum drawdown for pumping tests, or (2) the injection rate and maximum water level rise for injection tests (assuming the drawdown and water level rise had stabilized) during each test step. The upper aquifer zone step-drawdown test was conducted in three steps. The upper aquifer zone step-injection test and the deep aquifer zone step-drawdown pumping test were each conducted in four steps. The specific capacity is calculated using the following equation:

$$q_i = \frac{Q_i}{s_i} \quad (5-27)$$

where

q_i	=	Specific capacity [L^2T^{-1}]
Q_i	=	Pumping (or injection) rate [L^3T^{-1}]
s_i	=	Maximum drawdown (or water level rise) [L]

Figures C1, E1, and F1 (Appendices C, E, and F) show the water levels during the step tests. Table 5-3 shows the step test data and calculated specific capacities for each step of the tests. Based on the upper aquifer step-drawdown test, specific capacity of the NoVOCs™ well calculated for various steps ranges from 1.35 to 1.70 gpm/ft, with the average of 1.48 gpm/ft. The upper aquifer injection test shows similar results, and the calculated specific capacity ranges from 1.45 to 1.57 gpm/ft, with the average of 1.50 gpm/ft. The specific capacity values estimated from the deep aquifer step-drawdown test are higher than for the upper aquifer zone. The calculated specific capacity for the deep aquifer ranges from 3.02 to 3.51 gpm/ft, and the average specific capacity is 3.22 gpm.

5.2.2 Well Loss and Well Efficiency

The theory and concept of well loss and well efficiency and applied approaches for step-drawdown test data analysis have been extensively discussed in the literature. Currently, there are still different theories and approaches to calculate well efficiency. This section presents a brief evaluation of different approaches (Section 5.2.2.1) and calculation of well loss and well efficiency for the NoVOCs™ well based on the step-drawdown and step-injection test data (Section 5.2.2.2).

5.2.2.1 Evaluation of Different Approaches

The discussion of well loss and well efficiency are somewhat conflicting and confusing, as reflected in the literature (Jacob 1947; Rorabaugh 1953; Driscoll 1986; and Kawecki 1995). According to Jacob (1947), total drawdown in a pumping well can be divided into two components: (1) aquifer drawdown that can be described as a linear (first order) function of pumping rate and (2) well loss (caused by turbulent flow) that can be described as an second-order function of the pumping rate, as follows:

$$s = BQ + CQ^2 \quad (5-28)$$

where

s	=	Total drawdown (or water level rise) in the pumping (injection) well [L]
Q	=	Pumping rate [L^3T^{-1}]
B	=	Aquifer drawdown coefficient [$L^{-2}T$]
C	=	Well loss coefficient [$L^{-5}T^2$]

Rorabaugh (1953) proposed a more general empirical form of well loss that is described as a n^{th} -order function of the pumping (or injection) rate. Thus, the total drawdown can be expressed as follows:

$$s = BQ + CQ^n \quad (5-29)$$

Step-drawdown tests are commonly used to determine B, C, and n. Rorabaugh (1953) used n values ranging from 2.43 to 2.82; however, Lennox (1966) reported that $n=3.5$ was more suitable for his step-drawdown test data analysis. In practice, Equation 5-28 has been more widely used and the well loss component is generally considered a second-order function of the pumping rate ($n=2$). BQ represents aquifer drawdown caused by pumping, and CQ^2 represents the well loss. Once the coefficients B and C are determined, the well efficiency E_{well} (in percent) is calculated as follows:

$$E_{\text{well}} = \frac{s - CQ^2}{s} \times 100 \quad (5-30)$$

Driscoll (1986) pointed out that Jacob's and Rorabaugh's definitions of well loss and well efficiency were inadequate and that their assumptions that well loss is attributable to turbulent flow and aquifer drawdown is attributable to laminar flow were incorrect. Based on Driscoll (1986), a portion of the CQ^2 term might actually come from aquifer drawdown and portion of BQ term might include well losses. Driscoll's conclusion was reportedly based on testing of hundreds of wells, however, no details were given regarding the tests and data.

Kawecki (1995) concluded that traditional methods of analyzing step-drawdown test data produce information (well loss and well efficiency) that can be misleading, inaccurate, or meaningless. Kawecki's conclusion is based on the assumption that well losses include both linear and nonlinear components.

Kawecki separated the aquifer drawdown coefficient (B) into B_1 and B_2 ; where B_1 represents the “true aquifer drawdown” coefficient as a function of “real well radius” and time, and B_2 represents the linear well loss coefficient.

Calculating the well efficiency based on the “true aquifer drawdown” and “real well radius” is not a simple task because the “true aquifer drawdown” cannot be readily measured in most cases. Calculated aquifer drawdown is generally not accurate because of uncertainties associated with the parameters and model assumptions. The methods provided by Driscoll (1986, page 558) and Kawecki (1995) both require accurate values for aquifer and pumping well parameters. Driscoll’s and Kawecki’s examples show that the calculated well efficiencies based on the aquifer and pumping well parameters can have a large range of values because of uncertainties of the estimated parameter values. Therefore, the methods by Driscoll and Kawecki are inaccurate and impractical.

Dawson and Istok (1991) proposed two methods to determine the well efficiency. The first method is similar to the Driscoll (1986) method that requires calculation of the theoretical aquifer drawdown based known aquifer transmissivity and storativity values. The second method plots distance-drawdown data from at least three observation wells and extrapolates a straight fitted line to project aquifer drawdown at the pumping well. There are two problems with this method: (1) aquifer drawdown is not a linear function of distance, nor a logarithmic linear function of distance because Jacob simplification of Theis equation is not valid for short duration of step-drawdown tests; and (2) a large extrapolation will pose significant error in determining the actual aquifer drawdown at the pumping well. Both methods proposed by Dawson and Istok, therefore, are also inaccurate and impractical.

Well efficiency calculation in this study is based on the traditional concepts that well losses are caused by turbulent flow near and within the pumping well and aquifer drawdown is a result of laminar flow. The well losses can be described as a second-order function of pumping rate and aquifer drawdown is determined as a linear function of the pumping rate (Equation 5-28). For this study, it is believed that Equations 5-28 and 5-30 is adequate and applicable to calculate the well efficiency.

5.2.2.2 Calculation

Well loss and well efficiency can be calculated using graphical methods and computational approaches based on step-drawdown pumping test data. A simple graphical method that has been widely used is to plot s/Q versus Q (Bierschenk 1964). Rearranging Equation 5-28, s/Q can be expressed as:

$$\frac{s}{Q} = B + CQ \quad (5-31)$$

Based on Equation 5-31, s/Q versus Q plots should yield a straight line with slope C and y-axis intercept B .

The disadvantages of this graphical approach are: (1) high uncertainty because multiple steps (at least three) of step-drawdown test data may not adequately fit a straight line (low correlation coefficient); and (2) calculation error will increase significantly when the pumping rate is relatively low and well loss is small (nearly a horizontal line).

The straight line graphical method is not appropriate for analyzing the NoVOCsTM well step test data because s/Q versus Q plots are scattered. The data poorly match a straight line (correlation coefficient, R^2 , is less than 0.62; see Figures 5-20 and 5-21). In some cases, a straight line cannot be obtained. Examples of s/Q versus Q are presented in Figures 5-20 and 5-21.

A new graphical approach developed for this investigation was therefore used instead to calculate aquifer drawdown and well loss coefficients (B and C) in this study. The observed total drawdown (s) versus pumping rate (Q) is plotted and a best-fit second order polynomial function is generated using the least-square method (Figure 5-22 through Figure 5-24). Based on Equation 5-29, parameters B and C are determined by the best-fit curves. Figures 5-22 through 5-24 show that the correlation coefficients (R^2) of the best-fit equations range between 0.97 to 0.99. For the upper aquifer injection test, water level rise is used instead of drawdown (Figure 5-23).

Well efficiency calculation results are presented in Table 5-4. As shown in the table, the calculated well efficiencies for both shallow and deep NoVOCsTM wells are quite high, ranging from 77 to 99 percent. These efficiencies indicate that well losses through the well screen and sand pack are relatively low for

the pumping and injection rates used in the step tests. The well efficiency will decrease when pumping rates increase.

Table 5-4 also shows that the shallow well injection efficiency (average 97 percent) is higher than the pumping efficiency (average 82 percent). There are several explanations for the higher injection efficiency. First, the shallow well was redeveloped just before the injection test because of the inadvertent injection of turbid water from a dirty hose. The well was subsequently pumped intensively (five times the volume of water injected) to clean the well. Second, the injected water was clean tap water that was less turbid than the aquifer water being pumped. Third, uneven cuts of screen slots between the inside and the outside of the well screen may cause outward (injection) flow to be less turbulent than inward (pumping) flow.

The injection efficiency calculated using the step-injection test data is consistent with the well efficiency based on measured water level rises inside and outside of the well screen (upper piezometer data). Well efficiency was also evaluated using the dipole test data (see Section 5.5 of this report). The dipole test data may be more representative of the NoVOCsTM operation efficiency because injected water was drawn directly from the deep aquifer. Conversely, the injected water used for the upper aquifer injection test was clean tap water. Clean tap water has different physical and chemical characteristics (particularly turbidity, pH, and Eh) from the aquifer water, and it may have affected the injection test results.

5.3 AQUIFER HYDRAULIC PARAMETER CALCULATION

This section analyzes the data from the constant discharge pumping test conducted in the upper screened portion of the NoVOCsTM well and presents calculations of values for various aquifer hydraulic parameters. Many analytical models are available to analyze pumping test data and calculate aquifer hydraulic parameters. Different models were developed to simulate a variety of aquifer conditions. The first and most critical step in a pumping test data analysis is to select an appropriate model (or models) for the specific aquifer conditions, pumping and observation well construction, and pumping test configurations.

The analytical model for the NoVOCsTM well pumping test data evaluation was selected based on the site hydrogeologic conceptual model, the pumping test configuration (including pumping and observation well construction), and the pumping test drawdown response characteristics. Section 5.3.1 summarizes the site hydrogeology and presents the site hydrogeologic conceptual model. Section 5.3.2 describes the

pumping test configuration. Section 5.3.3 discusses the drawdown response characteristics of the pumping test. Section 5.3.4 discusses selection of the analytical model, and describes the selected model and its applicability. The results of parameter calculation are discussed in Section 5.3.5.

5.3.1 Site Hydrogeologic Conceptual Model

The site hydrogeology has been discussed in Section 2.5. The site hydrogeological conceptual model for the tested aquifer is summarized as follows:

- The aquifer is a thick layer of fine sand that is generally composed of artificial fill and shallow marine-deposited sediments. The aquifer extends from the ground surface to a depth of approximately 105 feet bgs across the site.
- The aquifer is underlain by an impermeable layer (aquitard) of clay (the B clay), which forms the base of the aquifer. Several less permeable layers such as dense or silty sand and the A silt/clay exist within the aquifer in variable thicknesses (generally less than a few feet); none of these less permeable layers behave as significant aquitards because they are relatively thin and lack lateral continuity.
- Although the aquifer is heterogeneous and anisotropic in a large scale, it can be considered homogenous and horizontally isotropic within the zone of pumping influence because the grain size of the fine sand layer is relatively uniform. The aquifer is vertically anisotropic.
- The aquifer is generally under unconfined conditions. The lower portion of the aquifer below the dense sand layer may be under semiconfined conditions.
- The initial water level in the tested aquifer was observed at approximately 17 feet bgs. Groundwater generally flows to the west toward San Diego Bay; however, the groundwater gradient is small and relatively flat.
- Groundwater recharge and discharge are primarily through lateral flow. Vertical infiltration is another source of groundwater recharge. No precipitation occurred during the pumping test period; therefore, the vertical recharge is negligible.
- San Diego Bay is considered a lateral boundary of the aquifer. However, the drawdown responses from the pumping test do not reach the bay, which is approximately 1,000 feet from the test site. Consequently, boundary effects of pumping are considered insignificant.
- The aquifer is tidally influenced. Tidal influence correction may be needed for the drawdown responses in the observation wells.

5.3.2 Constant Discharge Pumping Test Configuration

Pumping test configuration is important in selecting analytical models. Construction details of the pumping and observation wells, the pumping rate and duration, and the spatial orientation of the observation wells for this pumping test study are discussed in Sections 4.1 and 4.3. The constant discharge pumping test configuration was as follows:

- Groundwater was pumped from the upper screened interval of the NoVOCs™ well, which is 43 to 47 feet bgs.
- Pumping well diameter is 8 inches, and boring diameter is 14 inches (including sand pack).
- Pumping rate was kept constant at 20 gpm.
- Pumping duration was 32 hours.
- Initial groundwater level was approximately at 17 feet bgs.
- Saturated thickness of the tested aquifer was estimated at 88 feet.
- Drawdown was monitored in 10 observation wells surrounding the pumping well, but the data logger malfunctioned at two of the observation wells (MW-50 and -51).
- Distances between the observation wells and the pumping well range from 27.7 to 107.9 feet.
- Most of the observation wells have 5-foot screens, except for MW-54 which has a 40-foot screened interval.
- The observation wells are screened at various depths of the aquifer, ranging from 38 to 78 below ground surface.
- The pumping well and all of the observation wells are all partially penetrating wells.

Table 5-5 summarizes the pumping test configuration; this information was used for data interpretation and calculation of aquifer hydraulic parameters.

5.3.3 Drawdown Response Characteristics

In general, drawdown data from the pumping and observation wells are plotted in linear, semilogarithmic, and logarithmic scales. By comparing the drawdown plots with type curves, many important features of the aquifer conditions can be characterized. Some of the important features include well loss or wellbore

storage effects, pumping rate variations, leaky aquifer condition, positive (recharge) or negative (impermeable) boundaries, and delayed yield effects.

Evaluation of drawdown responses for this pumping test study is complicated because of tidal influences during the test. The magnitude of the maximum observed drawdowns in each of the observation wells is similar to the magnitude of the tidal fluctuations in the aquifer (see Figures 5-12 through 5-19).

Therefore, data cannot be analyzed before tidal correction is made. The tidal influence correction procedure and corrected drawdown results were described in Section 5.1 of this report. The drawdown data analysis of all the observation wells is based on the corrected data. The pumping well drawdown (more than 16 feet) was significantly greater than the tidal fluctuations in the groundwater level (less than 0.8 feet). Consequently, the pumping well data do not need correction for tidal influence.

Table 5-6 summarizes the drawdown responses for all wells during the constant discharge pumping test. The initial response time is the time at which drawdown in an observation well is first positively identified. The water levels were affected by tidal influence, and the maximum drawdown values presented in Table 5-6 may include numerical error caused by the tidal correction.

The initial response time and maximum drawdown observation wells show that the wells constructed at different depths all responded to pumping in the upper aquifer zone. There are slight variations in response time and maximum drawdown at the well cluster nearest to the pumping well (MW-45, MW-46, and MW-47). These slight variations disappeared with distance from the pumping well, as noted in well cluster MW-48 and MW-49, with the response time increasing and maximum drawdown decreasing with depth. This type of response shows that the vertical hydraulic connection between the upper aquifer zone and lower aquifer zone is good; the dense or silty sand layers do not behave as a significant aquitard.

Table 5-6 also shows that the maximum drawdown and response time in the observation wells vary inversely with distance from the pumping well. This inverse relationship indicates that the aquifer is relatively homogeneous and isotropic in horizontal directions.

The log-log plots of the drawdown data for the observation wells (Figures 5-25 through 5-32) shows that the early data follow the Neuman type curve A closely. These early data were recorded in a short period during which the tidal influence is insignificant; therefore, tidal correction is minimal. The corrected late drawdown data clearly show the delayed yield effects that may be attributed to delayed gravity water

releases near the water table or the vertical flow component caused by partially penetrating pumping and observation wells. The late data may also include errors in the tidal influence correction.

The following summarizes the drawdown responses of the observation wells during the constant discharge pumping test:

- Drawdown responses were identified in all of the observation wells within a radius of 108 feet; positive identification of drawdown is defined as drawdown is greater than 0.01 feet (any data recorded below 0.01 feet include significant transducer and data logger error).
- Early drawdown responses in the wells show that the data plots closely follow the Theis-type curve; the intermediate and later data indicate delayed gravity yield effects.
- In horizontal directions, maximum drawdown decreases, while the response time increases, with distance from the pumping well, suggesting horizontal homogeneity and isotropy of the aquifer.
- In vertical directions, slight differences in maximum drawdown and responding time were observed among the well clusters 30 feet away from the pumping wells. The differences are less distinguishable in the well cluster 60 feet from the pumping well. These differences may indicate that vertical anisotropy exists within the tested aquifer; however, a significant or continuous aquitard probably does not exist between the upper and lower aquifer zones.

5.3.4 Selection of Analytical Model

Based on the site hydrogeologic conceptual model, the pumping test configuration, and drawdown response analysis discussed in the previous sections, the tested aquifer is considered a thick unconfined aquifer with some vertical anisotropy. Both the pumping well and observation wells partially penetrate the aquifer. Neuman's delayed yield model for partially penetrating wells in an unconfined aquifer (Neuman 1975) was selected as the most appropriate analytical model for the pumping data test analysis.

Neuman's model simulates two stages of groundwater release from an unconfined aquifer to a pumping well. At the early stage of the test, groundwater is released from the aquifer by water pressure decreases and aquifer compression. At the later stage, groundwater is primarily released by gravity drainage of the aquifer matrix (delayed yield), which usually causes a decrease in the groundwater drawdown rate.

Four parameters can be calculated by curve matching techniques used in the Neuman method: transmissivity (T), storativity (S), specific yield (S_y), and Neuman delayed yield factor (β). Aquifer transmissivity is defined as hydraulic conductivity multiplied by aquifer thickness; it measures the volume of groundwater that flows through a vertical area defined by unit width and entire thickness of the aquifer per unit time under unit groundwater gradient. Storativity measures the aquifer potential for water release by pressure decrease and aquifer compression, defined as the volume of water released from storage per unit surface area of aquifer per unit decline in hydraulic head. Specific yield measures unconfined aquifer potential for water release by gravity drainage; it is defined as the volume of water released from storage in an unconfined aquifer per unit aquifer volume. The Neuman delayed yield factor measures the effect of delayed yield from vertical gravity drainage and is related to the ratio of vertical hydraulic conductivity to horizontal hydraulic conductivity (K_z/K_r), defined as follows (Neuman 1975):

$$\frac{K_z}{K_r} = \mathbf{b} \frac{b^2}{r^2} \quad (5-32)$$

where

β	=	Neuman delayed yield factor [dimensionless]
b	=	Saturated thickness of the aquifer [L]
r	=	Distance from the pumping well to the observation well [L]
K_z	=	Vertical hydraulic conductivity of the aquifer [LT^{-1}]
K_r	=	Horizontal hydraulic conductivity of the aquifer [LT^{-1}]

5.3.5 Results and Discussion

Aquifer hydraulic parameters were calculated using the groundwater pumping test data analysis software package AQTESOLV™ (Duffield and Rumbaugh 1991; HydroSOLVE 1996). The Neuman delayed yield model for partially penetrating wells in unconfined aquifers was selected to analyze the groundwater drawdown data corrected for tidal influence. Log-log plots of drawdown versus time were prepared, and the plots were matched visually with the Neuman type curves. The automatic matching option (using the least-square computational approach) offered by AQTESOLV™ was not used because the computational method is insensitive to the early data match and biased toward the data in the late stage of the test. The late data may include more errors caused by tidal influence and tidal correction. In addition, early data matched to Neuman's type curve A is important for accurate estimation of aquifer hydraulic parameters.

Figures 5-25 through 5-32 show the drawdown plots and the Neuman type curve matching for the various observation wells. As shown in the figures, the Neuman delayed yield type curves match well with the corrected drawdown plots. The drawdown data clearly illustrate the delayed gravity drainage effects. The curve matches in these figures indicate that the aquifer parameter calculation based on the pumping test data is representative.

Table 5-7 presents the results of the aquifer hydraulic parameter calculation using AQTESOLV™. The calculated aquifer hydraulic parameters are summarized as follows:

- The calculated aquifer transmissivity ranges from approximately 2,200 to 2,780 ft²/day. The aquifer hydraulic conductivity was calculated based on the saturated aquifer thickness of 88 feet, ranging from 25 to 32 feet per day (ft/day) or 0.009 to 0.011 cm/sec. The range of the estimated hydraulic conductivity is typical for fine sand, which is consistent with the aquifer's lithologic conditions at the site.
- The estimated aquifer storativity ranges from approximately 0.001 to 0.008. In the Neuman delayed yield model, storativity represents the elastic release of water from the aquifer matrix at an early stage of the pumping test.
- Specific yield of the testing aquifer ranges from 0.02 to 0.12, approximately one to two orders of magnitude greater than the storativity values. The estimated specific yield values are within the typical range for unconfined aquifers.
- The estimated ratio of vertical to horizontal hydraulic conductivity ranges from 0.08 to 0.3. The ratios were calculated from the Newman delayed yield factor based on equation 5-32. The calculated ratios indicate the aquifer is considerably anisotropic in the vertical direction.

Generally, the estimated aquifer hydraulic conductivity values may represent the average horizontal properties of the testing aquifer. The hydraulic conductivity values calculated from data for the observation wells near the pumping well may be more representative of the upper zone condition. The calculated transmissivity, storativity and specific yield values are relatively constant for various depths of screened intervals and different distances from the pumping well, showing that the hydraulic property of the aquifer is relatively homogeneous.

5.4 DETERMINATION OF GROUNDWATER FLOW PATTERNS

Previous site investigations indicate that groundwater generally flows west in the vicinity of the NoVOCs™ well. However, the mean groundwater flow direction and the horizontal and vertical

hydraulic gradients have not been adequately characterized in those investigations because tidal effects and variable groundwater densities caused by sea water intrusion were not considered. This section discusses the principles, procedures, and results of groundwater flow pattern determination, including mean groundwater level calculation from tidally influenced water levels and density correction for groundwater hydraulic gradient.

5.4.1 Mean Groundwater Level Calculation from Tidally Influence Water Levels

One widely applied method to calculate mean groundwater elevation from tidally influenced water levels was developed by Serfes (1991). The Serfes method is a three-step filtering approach (calculating moving averages) that uses hourly groundwater level data collected during a 70-hour period. The three-step filtering approach provides more accurate average groundwater levels than the straight arithmetic mean. The Serfes method was modified as explained below because water level data unaffected by aquifer testing for 70-hour periods were not available. The periods of data unaffected by pumping tests ranged from 30 to 62 hours. Also, the Serfes method was modified to allow the use of data collected more frequently than the 1-hour interval specified by Serfes (1991). Water levels were monitored at 20-minute intervals for the upper aquifer zone wells and at 15-second intervals for some of the lower aquifer zone wells.

The modified method is based on an average period of approximately 25 hours for a complete tidal cycle consisting of two high tides and two low tides. The procedures for the modified method for data of 20-minute frequency are as follows:

1. For a 50- to 75-hour groundwater elevation data series $\{H_i, i = 1, 2, \dots, n\}$ with $149 \leq n \leq 224$, compute the first sequence of means $\{X_j, j = 1, 2, \dots, n-74\}$ as follows:

$$X_j = \frac{1}{75} \sum_{m=0}^{74} H_{m+j} \text{ where } j = 1, 2, \dots, n - 74 \quad (5-33)$$

where

$$\begin{aligned} X_j &= \text{The first sequence of means [L]} \\ H_{m+j} &= \text{Groundwater elevation data in 20-minute interval [L]} \end{aligned}$$

2. Then, the second sequence of means $\{Y_k\} \{k=1, 2, \dots, n-142\}$ is calculated as follows:

$$Y_k = \frac{1}{75} \sum_{m=0}^{74} X_{m+k} \quad \text{where } k = 1, 2, \dots, n-148 \quad (5-34)$$

where

$$\begin{aligned} Y_k &= \text{The second sequence of means [L]} \\ X_{m+k} &= \text{The first sequence of means [L]} \end{aligned}$$

3. Finally, the mean groundwater elevation M is calculated as follows:

$$M = \frac{1}{n-148} \sum_{k=1}^{n-148} Y_k \quad (5-35)$$

where

$$M = \text{The mean groundwater elevation [L]}$$

The mean groundwater elevations for wells MW-45, MW-47, and the upper screen of the NoVOCs™ well were calculated using an electronic spreadsheet following the procedures above. Groundwater level data for wells MW-48, MW-49, MW-52, and MW-53 were recorded in 15-second intervals; therefore, calculation procedures for the mean elevation were further modified to use all the data that had been collected. The principle of this modification is the same as discussed above.

The mean groundwater elevations calculated for wells MW-45, MW-48, MW-52, and the upper screen of the NoVOCs™ well represent groundwater flow patterns in the upper aquifer zone. The mean groundwater flow direction in the lower aquifer zone was characterized by the mean water elevation data from wells MW-47, MW-49, and MW-53. Data for other monitoring wells were not used because the wells were either constructed between the two zones or fully penetrate the aquifer. Groundwater elevation data for some of the wells are not available.

5.4.2 Density Correction of Groundwater Levels

Evaluation of groundwater flow pattern in the vicinity of the NoVOCs™ well is further complicated by seawater intrusion. The salinity of groundwater at the site is generally 2 to 3 percent and the density of groundwater samples from almost all the monitoring wells is greater than 1 gram/cubic centimeter (g/cm^3). In addition, groundwater density varies by well location and depth. In general, the density of

groundwater is higher in the lower aquifer zone. In the following sections, the calculation of equivalent fresh-water heads and the correction of groundwater levels measured by pressure transducers are discussed.

5.4.2.1 Calculation of Equivalent Fresh-Water Heads

Calculation of equivalent fresh-water heads (elevations) from an aquifer with variable water density is the first step of the density correction. Equivalent fresh-water heads plotted on maps and contoured are necessary to estimate horizontal groundwater flow direction and hydraulic gradient. The apparent head measurements in a density-variable aquifer should not be used to plot groundwater level contour maps: the contours of such plots will be misleading because the density effect can cause water to flow from apparent low to apparent high heads.

The following discussion presents the principles and procedures for calculating the equivalent fresh-water head. Density correction procedures for data collected by pressure transducer are different from those for manual measurements using water level indicators.

Groundwater hydraulic head is a sum of elevation head and pressure head, described as follows (Freeze and Cherry 1979):

$$h = z + \Psi \quad (5-36)$$

where

- h = The hydraulic head [L]
- z = Elevation of the point of measurement [L]
- Ψ = The pressure head [L]

The pressure head of groundwater is a function of gage pressure and groundwater density; therefore, the hydraulic head can be further defined as follows:

$$h = z + \frac{P}{\rho g} \quad (5-37)$$

where

- p = Groundwater gage pressure [ML⁻¹T⁻²]
- ρ = Groundwater density [ML⁻³]
- g = Gravitational acceleration [LT⁻²]

Equation 5-37 shows that the hydraulic head (h) for higher density water will be less than the hydraulic head for fresh water under the same pressure and elevation conditions. Groundwater does not necessarily flow from the higher head to the lower head under this circumstance.

From Equation 5-37, the measured groundwater elevation above the MLLW in a monitoring well at the site is as follows:

$$h = z + \frac{p}{\rho_b g} \quad (5-38)$$

where

- h = The measured groundwater elevation using water level indicator [L]
- ρ_b = Density of groundwater in the well [ML⁻³]
- z = Elevation of the middle point of the well screen above (positive) or below (negative) a datum [L]
- p = Groundwater gage pressure at the middle point of the well screen [ML⁻¹T⁻²]

Also from Equation 5-37, the equivalent fresh-water head above the datum in the monitoring well is given by:

$$h^* = z + \frac{p}{\rho_0 g} \quad (5-39)$$

where

- h* = Equivalent fresh water head above the datum [L]
- ρ₀ = Density of fresh water (assumed to be 1) [ML⁻³]

Considering that the gage pressure of groundwater in the well is constant, Equations 5-38 and 5-39 can be combined to obtain the following equation:

$$(h^* - z)\rho_b g = (h - z)\rho_b g \quad (5-40)$$

Rearranging Equation 5-40 and substituting specific gravity $\gamma = \rho_b/\rho_0$ into the equation, the equivalent fresh-water head, h^* , is defined as follows:

$$h^* = \gamma h + (1 - \gamma)z \quad (5-41)$$

where

$$\gamma = \text{Specific gravity of the groundwater [dimensionless]}$$

Equation 5-41 should be used to calculate equivalent fresh-water head based on the water level measurements collected manually by water level indicators. Equation 5-41 may be used for pressure transducer data under certain circumstances, as explained in the next section.

5.4.2.2 Correction of Groundwater Levels Measured by Pressure Transducer

Pressure transducers measure water pressure. The water pressure reading is usually converted by data logger software to a water head above the transducer. The conversion is usually based on the density of fresh water (Equation 5-39). If the water density differs from that of fresh water but the conversion is based on fresh water, the resulting water head value will be the fresh water equivalent head relative to the transducer. If the conversion is based on the actual density of the water (Equation 5-38), the resulting water head value will be the actual water head relative to the transducer. Correcting pressure transducer data for density effects depends on whether raw pressure data were converted to heads using fresh water density or actual water density. Correcting the data also depends on (1) the manner in which the data logger software processes the data, (2) whether initial water levels input into the data logger have been corrected for density effects, and (3) whether multiple manual water level measurements are available for the data recording period. Several cases of data handling are discussed below (data logger configurations are described in bold, followed by an explanation of corrections that should be applied):

- **Case 1: The actual density of the groundwater was measured and the data logger used actual density to convert pressure data to water head above the transducer. The initial water level, measured manually and input into the data logger, was not corrected for density effects.**

All water levels recorded by the data logger are actual water levels and not fresh-water equivalent water levels. Equation 5-41 should be used to convert all water level data output from the data logger.

- **Case 2: The actual density of the groundwater was measured. The initial water level (manually measured) was corrected to a fresh-water equivalent using Equation 5-41 and input into the data logger. The data logger used fresh-water density to convert pressure to fresh-water equivalent head above the transducer. The data logger was set up to record changes from the initial water level.**

No additional density correction is required. All data logger output will be fresh-water equivalent water levels.

- **Case 3: Actual density of groundwater was not considered in the data logger configuration. Multiple manual measurements of water levels were collected during the recording period.**

Using the manual measurements, which represent the apparent groundwater elevations, the pressure transducer data should be adjusted to also represent apparent groundwater elevations. Equation 5-41 can then be applied to the entire adjusted data set to obtain equivalent fresh-water elevations.

- **Case 4: Actual density of groundwater was not considered in the data logger configuration. Only initial manual measurement of water levels was collected during the recording period.**

The change in water level from the initial data point should be calculated for each pressure transducer data point. The initial pressure transducer data point should be adjusted to represent the apparent water level elevation based on the initial manual water level measurement. Equation 5-41 should be applied to the adjusted initial groundwater elevation to obtain the initial fresh-water equivalent elevation. No density correction is needed for the water-level changes calculated from the pressure transducer data. The water-level changes should be directly added to or subtracted from the density-corrected initial groundwater elevation to obtain fresh-water equivalent elevations for the entire data set.

5.4.3 Corrected Water Levels and Horizontal Groundwater Flow Direction

Groundwater elevations and drawdown changes were measured using pressure transducers during the various phases of the aquifer tests. Manual water level measurements were also collected at the pumping well and at most observation wells during the tests. The data were corrected following the procedures specified for the Case 3 and Case 4 examples discussed in the previous section. The corrected results are presented in Appendixes C through G.

Static groundwater levels were corrected for tidal influence following the procedures discussed in Section 5.4.1. Mean groundwater elevations for the upper aquifer zone were calculated using the upper screen of NoVOCsTM well and the three upper zone NoVOCsTM observation wells (MW-45, MW-48, and MW-52). Mean groundwater elevations for the lower aquifer zone were calculated using the three lower zone NoVOCsTM observation wells (MW-47, MW-49, and MW-53). The mean groundwater elevations after tidal correction are listed in Table 5-8.

The equivalent fresh-water heads of the mean groundwater elevations were calculated following the procedures discussed in Section 5.4.2. The first step of the calculation is to obtain density data for various monitoring well locations and aquifer depths because the groundwater density was not directly measured. Jacobs Engineering Group, Inc. (1995b) applied an empirical equation developed by de Marsily (1986) to calculate groundwater density from total dissolved solids (TDS) data. The empirical equation was developed based on a laboratory test with sodium chloride solution and a linear regression analysis.

The empirical equation developed by de Marsily (1986) is as follows:

$$\rho = (6.87 \times 10^{-4} C_{TDS}) + 998.4575 \quad (5-42)$$

where

- ρ = Groundwater density (kg/m³)
- C_{TDS} = TDS concentration (mg/L)

The groundwater density and results for equivalent fresh-water head calculation are presented in Table 5-8.

The mean equivalent fresh-water head contours for the upper aquifer zone are plotted in Figures 5-33 and 5-34. Figure 5-33 is based on four points (including data for well MW-48), and Figure 5-34 is based on three points (excluding data for well MW-48). The two presentations (with and without data for well MW-48 data) are provided because the screen of well MW-48 is at a lower elevation than in the other three wells used to construct the contours. The mean equivalent fresh-water head contours for the lower aquifer zone are plotted in Figure 5-35. These contour maps represent the mean static water levels and flow directions with tidal and pumping influences removed. Effects caused by variation in groundwater

density variation were also corrected. These contour maps are considered representative of the natural groundwater flow pattern.

As shown in Figures 5-33, 5-34, and 5-35, groundwater generally flows to the west or northwest in both of the upper and lower aquifer zones. The horizontal hydraulic gradient in both aquifer zones is relatively flat, ranging from 0.005 to 0.01 feet per feet in the upper zone and approximately 0.006 in the lower zone. Data for generating the contour maps were limited (four points for the upper aquifer zone and three points for the lower aquifer zone) because other NoVOCsTM observation wells were completed at depths between the two aquifer zones. Also, data were not available for some of the observation wells because of data logger malfunction.

5.4.4 Vertical Hydraulic Gradient Correction

Calculation of vertical hydraulic gradient in a fresh-water aquifer (groundwater density of 1 g/cm³) is simple: for two vertically aligned wells, the vertical hydraulic gradient equals the head difference between the wells divided by the distance between the midpoint of the well screen intervals. However, calculation of vertical hydraulic gradient in a density-variable aquifer is relatively complex. Incorrect calculations of the vertical hydraulic gradient by simply using equivalent fresh-water heads to determine the head difference are common. The vertical hydraulic gradient in a density-variable aquifer is a function of the equivalent fresh-water heads, the distance between the two intervals, and the groundwater density. This section discusses the principles and the reason for calculating vertical hydraulic gradient differently from the horizontal hydraulic gradient. The procedures to calculate the vertical hydraulic gradient in a density-variable aquifer are also presented.

Vertical hydraulic gradient is not calculated in this report because limited groundwater density data are available. Also, vertical hydraulic gradient was not identified as a key parameter in the pumping test data analysis and NoVOCsTM well evaluation. The equations and procedures discussed in this section can be followed in future data analysis for the vertical hydraulic gradient at the site.

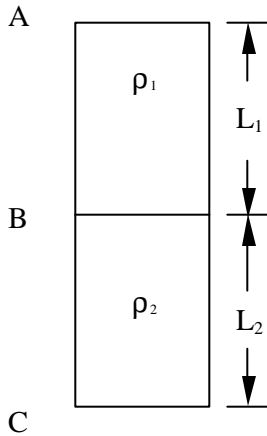

Considering water column ABC filled with a porous medium as shown in the Drawing: the upper portion, AB, has a height L_1 and contains water (or any fluid) with a density equal to ρ_1 ; the lower portion, BC, has a height of L_2 and contains water with a density equal to ρ_2 . Water in the column is assumed to be in a hydraulic steady state, that is, no vertical flow occurs. Vertical hydraulic gradient is to zero between any two points within the column. Also, it is assumed that no density-driven flow and no density diffusion occur across the boundary line B.

If the bottom of the column is set at the datum, that is, the elevation z equals zero at point C, from Equation 5-39, the equivalent fresh water-head at the three points (A, B, and C) will be given as:

$$h_A^* = z_A + \frac{p_A}{\rho_0 g} \quad (5-43)$$

$$h_B^* = z_B + \frac{p_B}{\rho_0 g} \quad (5-44)$$

$$h_C^* = z_C + \frac{p_C}{\rho_0 g} \quad (5-45)$$

where

- $p_A, p_B,$ and p_C = The groundwater pressure gages at points A, B, and C
 $z_A, z_B,$ and z_C = The elevations of points A, B, and C

Equations 5-43, 5-44, and 5-45 can be solved as follows, considering $p_A=0, p_B=\rho_1 g L_1, p_C=\rho_1 g L_1 + \rho_2 g L_2, z_A=L_1+L_2, z_B=L_2,$ and $z_C=0$:

$$h_A^* = (L_1 + L_2) + 0 = L_1 + L_2 \quad (5-46)$$

$$h_B^* = L_2 + \frac{\mathbf{r}_1 g L_1}{\mathbf{r}_0 g} = \mathbf{g}_1 L_1 + L_2 \quad (5-47)$$

$$h_C^* = 0 + \frac{(\mathbf{r}_1 L_1 + \mathbf{r}_2 L_2)g}{\mathbf{r}_0 g} = \mathbf{g}_1 L_1 + \mathbf{g}_2 L_2 \quad (5-48)$$

Because $\gamma_1 \neq \gamma_2 \neq 1$, Equation 5-46, 5-47, and 5-48 show that the equivalent fresh-water heads at the three points are not equal. This result contradicts the assumption that no vertical flow occurs in the water column. Therefore, the difference in the two equivalent fresh-water heads divided by the distance between the two points does not equal the vertical hydraulic gradient in aquifers with variable density groundwater.

In general, the vertical hydraulic gradient between two vertically aligned points within variable density groundwater equals the difference of the fresh-water equivalent heads at the two points divided by the distance plus a constant. That is:

$$I_{AB} = \frac{h_A^* - h_B^*}{L_1} + C_1 \quad (5-49)$$

$$I_{BC} = \frac{h_B^* - h_C^*}{L_2} + C_2 \quad (5-50)$$

$$I_{AC} = \frac{h_A^* - h_C^*}{L_1 + L_2} + C_3 \quad (5-51)$$

where

- I_{AB} = Vertical hydraulic gradient between points A and B.
- I_{BC} = Vertical hydraulic gradient between points B and C.
- I_{AC} = Vertical hydraulic gradient between points A and C.

From Equations 5-46, 5-47, and 5-48, considering $I_{AB} = I_{BC} = I_{AC} = 0$, for steady state condition, we can solve C_1 , C_2 and C_3 as:

$$C_1 = \frac{h_B^* - h_A^*}{L_1} = \frac{g_1 L_1 + L_2 - (L_1 + L_2)}{L_1} = g_1 - 1 \quad (5-52)$$

$$C_2 = \frac{h_C^* - h_B^*}{L_2} = \frac{g_1 L_1 + g_2 L_2 - (g_1 L_1 + L_2)}{L_2} = g_2 - 1 \quad (5-53)$$

$$C_3 = \frac{h_C^* - h_A^*}{L_1 + L_2} = \frac{g_1 L_1 + g_2 L_2 - (L_1 + L_2)}{L_1 + L_2} = \frac{g_1 L_1 + g_2 L_2}{L_1 + L_2} - 1 \quad (5-54)$$

Therefore, vertical hydraulic gradient between any two points in an aquifer with density-variable groundwater can be calculated using the following general equation (based on Equations 5-49 through 5-54):

$$I_v = \frac{h_u^* - h_l^*}{l} + (g - 1) \quad (5-55)$$

where

- I_v = Vertical hydraulic gradient between two vertically aligned points within the aquifer (positive value represents downward gradient) [dimensionless]
- h_u, h_l = The equivalent fresh water heads at the two points (higher elevation and lower elevation points, respectively) [L]
- l = Vertical distance between the two points [L]
- γ = Specific gravity of groundwater between the two points [dimensionless]

The specific gravity of groundwater between the two points should be carefully chosen when Equation 5-55 is used. If the groundwater density is not constant between the upper and lower aquifer zones, a thickness-weighted average of the specific gravity for multiple density strata should be used. The weighted average of the specific gravity is calculated as follows:

$$g = \frac{\sum_{i=1}^n g_i l_i}{\sum_{i=1}^n l_i}, \quad i = 1, 2, \dots, n \quad (5-56)$$

where

- γ = The weighted average of the specific gravity of groundwater
 γ_i = The specific gravity of the i^{th} strata
 l_i = The thickness of the i^{th} strata

5.5 DIPOLE FLOW TEST

The dipole flow test (DFT), a new single-well hydraulic test for aquifer characterization, was first proposed by Kabala (1993). The test was designed to characterize the vertical distribution of local horizontal and vertical hydraulic conductivities near the test well. Measures of the aquifer's anisotropy ratio and storativity can also be obtained through DFT data analysis. DFT is a cost-effective method for aquifer hydraulic characterization because (1) the test duration is short; the test generally lasts no more than a few hours, and (2) no investigation-derived waste is generated because the water from the pumping chamber is injected to the aquifer through recharge chamber.

5.5.1 Mathematical Models

Kabala (1993) presented a mathematical model describing drawdown (or water level rise) during a dipole flow test in each of the isolated chambers of a well situated in a leaky homogeneous anisotropic aquifer. Major assumptions for this original model are:

- The aquifer is homogeneous and anisotropic and horizontally situated
- The aquifer is under either leaky or confined conditions
- The test well fully penetrates the aquifer thickness
- Water is removed through one of the two open screened intervals and discharged to another interval instantaneously
- Linear vertical head distribution is assumed in the semiconfining layer (leaky aquitard)

- Water storage in the leaky aquitard is negligible
- Flows in the aquifer zones are mainly horizontal, but primarily vertical within the leaky aquitard
- Well bore storage and well losses are insignificant
- “Skin effect” (short-circuiting through the sand packs) is negligible

The analytical solutions for drawdown in the pumping chamber and water level rise in the recharge chamber are presented by Kabala (1993). The transient solution describing drawdown is given as follows:

$$s(t) = \frac{Q}{4pK_r b} \left\{ W(u_r; \beta_w) + \frac{2b^2}{4p^2 \Delta^2} \sum_{n=1}^{\infty} \frac{1}{n^2} \left[\sin \frac{np(d+2\Delta)}{b} - \sin \frac{npd}{b} \right]^2 W\left[u_r; \left(\beta_w^2 + \frac{(npr_w)^2}{a^2 b^2}\right)^{1/2}\right] \right\} \quad (5-57)$$

where

- $s(t)$ = Drawdown in the pumping chamber [L]
 t = Time since beginning of the test [L]
 Q = Pumping rate [$L^3 T^{-1}$]
 K_r = Horizontal hydraulic conductivity [LT^{-1}]
 b = Aquifer thickness [L]
 d = Distance from the top of aquifer to the top of the upper chamber [L]
 Δ = Half of the length of the screen interval [L]
 a^2 = Aquifer anisotropy ratio, defined as K_r/K_z [dimensionless]
 $W(u_r, \beta_w)$ = Leaky aquifer well function, defined as:

$$W(u_r; \beta_w) = \int_{u_r}^{\infty} \frac{1}{y} \exp\left(-y - \frac{\beta_w^2}{4y}\right) dy \quad (5-58)$$

where

- u_r = Dimensionless time, defined as: $r_w^2 S_s / 4K_r t$
 β_w = Leaky factor defined as: $r_w / (K_r b b' / K')^{1/2}$
 r_w = Radius of the well casing [L]
 S_s = Aquifer specific storage [L^{-1}]

- b' = Aquitard (semi-confining layer) thickness [L]
 K' = Aquitard vertical hydraulic conductivity [LT^{-1}]

A similar solution can be derived to describe water level rise due to injection in the recharge chamber with a negative pumping rate. Combining the pumping and injection effects, the actual drawdown in the pumping chamber is given by:

$$\begin{aligned}
 s(t) = & \frac{Q}{pK_r b} \sum_{n=1}^{\infty} \left[\frac{\sin(n p \Delta / b)}{n p \Delta / b} \right]^2 \\
 & \cdot \sin\left(n p \frac{l+d}{2b}\right) \sin\left(n p \frac{l-d-2\Delta}{2b}\right) \cos\left(n p \frac{d+\Delta}{b}\right) \cdot W\left[u_r; \left(b_w^2 + \frac{(n p r_w)^2}{a^2 b^2}\right)^{1/2}\right] \quad (5-59)
 \end{aligned}$$

The solution for actual water level rise in the recharge chamber is given by:

$$\begin{aligned}
 s(t) = & \frac{Q}{pK_r b} \sum_{n=1}^{\infty} \left[\frac{\sin(n p \Delta / b)}{n p \Delta / b} \right]^2 \\
 & \cdot \sin\left(n p \frac{l+d}{2b}\right) \sin\left(n p \frac{l-d-2\Delta}{2b}\right) \cos\left(n p \frac{l-\Delta}{b}\right) \cdot W\left[u_r; \left(b_w^2 + \frac{(n p r_w)^2}{a^2 b^2}\right)^{1/2}\right] \quad (5-60)
 \end{aligned}$$

Equations (5-59) and (5-60) are the transient solutions for the dipole flow test. The steady state solution for drawdown in the pumping chamber is as follows:

$$\begin{aligned}
 s(t) = & \frac{2Q}{pK_r b} \sum_{n=1}^{\infty} \left[\frac{\sin(n p \Delta / b)}{n p \Delta / b} \right]^2 \\
 & \cdot \sin\left(n p \frac{l+d}{2b}\right) \sin\left(n p \frac{l-d-2\Delta}{2b}\right) \cos\left(n p \frac{d+\Delta}{b}\right) \cdot K_0\left[\left(b_w^2 + \frac{(n p r_w)^2}{a^2 b^2}\right)^{1/2}\right] \quad (5-61)
 \end{aligned}$$

Where

- K_0 = Zero-order modified Bessel function of the second kind,
 l = Distance from the top of the aquifer to the bottom of the lower screen.

5.5.2 Modified Dipole Flow Test Solution for Wellbore Storage

Kabala (1998) developed a new DFT model to account for wellbore storage effects in the pumping and injection chambers. In the wellbore storage DFT model, measured drawdown (or water level rise) is the

sum of aquifer drawdown and wellbore storage drawdown. Dimensionless wellbore storage parameters for the pumping and recharge chambers are defined as:

$$C_{PD} = \frac{(r_i / r_w)^2}{4S} \quad (5-62)$$

$$C_{RD} = \frac{1 - (r_i / r_w)^2}{4S} \quad (5-63)$$

where

- C_{PD} = Dimensionless wellbore storage parameter for the pumping chamber
- C_{RD} = Dimensionless wellbore storage parameter for the recharge chamber
- r_i = Radius of inner well casing (eductor pipe)[L]
- r_w = Radius of well casing [L]
- S = Aquifer storativity or specific yield [dimensionless]

Laplace transformation is used to solve the partial differential equations that describe drawdown (or water level rise) in the pumping (or recharge) chamber during the DFT where the wellbore storage effect is considered. The drawdown in the pumping chamber s_{pump} can be described as:

$$s_{pump}(p) = s_{pp}(p) + s_{pi}(p) \quad (5-64)$$

where p is the Laplace transformation variable, $s_{pp}(p)$ is the drawdown caused by pumping, and $s_{pi}(p)$ is the water level caused by injection (expressed as negative drawdown). The two components of the water level response are defined as follows:

$$s_{pp}(p) = \frac{Q}{4pK_r b} \cdot \frac{\frac{2}{p} K_0(\sqrt{p}) + 4 \sum_{n=1}^{\infty} \frac{a_n^2}{p} K_0(\sqrt{p + g_n^2})}{C_{PD} p^2 \left[\frac{2}{p} K_0(\sqrt{p}) + 4 \sum_{n=1}^{\infty} \frac{a_n^2}{p} K_0(\sqrt{p + g_n^2}) \right] + 1} \quad (5-65)$$

and

$$s_{pi}(p) = \frac{-Q}{4pK_r b}$$

$$\cdot \left\{ 1 - \frac{\left[\frac{2}{p} K_0(\sqrt{p}) + 4 \sum_{n=1}^{\infty} \frac{b_n^2}{p} K_0(\sqrt{p + g_n^2}) \right] \left[\frac{2}{p} K_0(\sqrt{p}) + 4 \sum_{n=1}^{\infty} \frac{a_n^2 b_n^2}{p} K_0(\sqrt{p + g_n^2}) \right]}{C_{RD} p^2 \left[\frac{2}{p} K_0(\sqrt{p}) + 4 \sum_{n=1}^{\infty} \frac{b_n^2}{p} K_0(\sqrt{p + g_n^2}) \right] + 1} \right\} \quad (5-66)$$

Variables α_n , β_n , and γ_n are defined as follows:

$$a_n = \frac{b}{np\Delta_u} \cdot \sin\left(\frac{np\Delta_u}{b}\right) \cdot \cos\left[\frac{np(d + \Delta_u)}{b}\right] \quad (5-67)$$

$$b_n = \frac{b}{np\Delta_l} \cdot \sin\left(\frac{np\Delta_l}{b}\right) \cdot \cos\left[\frac{np(l - \Delta_l)}{b}\right] \quad (5-68)$$

$$g_n = \frac{np r_w}{b \sqrt{K_r / K_z}} \quad (5-69)$$

where:

Δ_u = Half of the upper screened interval [L]

Δ_l = Half of the lower screened interval [L]

5.5.3 Dipole Flow Test Data Interpretation and Aquifer Anisotropy Estimation

The dimensionless drawdown in the pumping chamber versus dimensionless time can be plotted as groups of type curves with different anisotropy ratios ($a^2 = K_r/K_z$) and storativity (or specific yield) values. The type curves are generated by plotting dimensionless drawdown s_D versus dimensionless time τ , which are defined as follows:

$$s_D = \frac{s(t)}{s(\infty)} \quad (5-70)$$

and

$$t = \frac{n t}{r_w^2} \quad (5-71)$$

where

- $s(\infty)$ = Steady state drawdown or water level rise during the DFT [L]
 v = Aquifer hydraulic diffusivity, defined as T/S or K_r/S_s [L^2T^{-1}]

Drawdown (or water level rise) data collected during the DFT then be normalized to dimensionless drawdown (or water level rise) with values ranging from 0 to 1, as follows:

$$s_D(t) = \frac{s(t+t_0) - s_{\min}}{s_{\max} - s_{\min}} \quad (5-72)$$

where

- $s_D(t)$ = Normalized dimensionless drawdown (or water level rise)
 $s(t+t_0)$ = Drawdown (or water level rise) at time $t+t_0$ [L]
 t_0 = The beginning time of a given step of the DFT [T]
 s_{\max} = The maximum drawdown (or water level rise) during a given step of the DFT [L]
 s_{\min} = The minimum drawdown (or water level rise) during a given step of the DFT [L]

The normalized drawdown or water level rise versus time are plotted for the type curve match. A scale factor (A) is applied to the real-time plots. The scale factor is applied for two purposes: (1) transferring real time to dimensionless time so the horizontal axes of the type curves and test data are comparable, and (2) adjusting the horizontal positions of the data plots so that a best match to one of the type curves can be obtained. The scale factor is defined as:

$$A = \frac{n}{r_w^2} = \frac{K_r}{S_s r_w^2} \quad (5-73)$$

From the type curve match, the aquifer anisotropy ratio is obtained from the value of parameter a^2 (which equals K_r/K_z). In addition, aquifer horizontal hydraulic conductivity can be calculated from the values of parameters S (or S_y), and A . The aquifer horizontal hydraulic conductivity K is calculated by the following equation:

$$K_r = \frac{A \cdot r_w^2 S}{b} \quad (5-74)$$

DFT data collected during Step 4 recovery in the recharge chamber were considered the most suitable for parameter estimation because the water level rise data were least affected by variations in pumping rate variations and head fluctuations.

Tidal influence during the DFT is removed using data collected from well MW-51. Comparison of water level data from the NoVOCsTM well and observation well MW-51 shows that the tidal fluctuations in the two wells are almost identical. Well MW-51 also had minimum impact from the DFT because of its distance from the NoVOCsTM well. The least-square algorithm was used to simulate the tidal fluctuations in the NoVOCsTM well. The drawdown (or water level rise) correction procedure is similar to the procedures presented in Section 5.1.

Figure 5-36 shows the recovery data plots and type curve match for the DFT Step 4 recharge chamber. The type curves are generated using the DFT model considering well bore storage. The group of the type curves in Figure 5-36 represents storativity $S=0.01$ and anisotropy ratios $a^2 = K_r/K_z = 100, 30, 10, 3,$ and 1 . The normalized dimensionless DFT recovery data with time are represented by circles, whereas the normalized recovery data versus scaled time (dimensionless time) are plotted as thick dash line.

From the DFT recovery data plots and type curve match (Figure 5-36), the aquifer hydraulic parameters are estimated as: $K_r = 0.0115$ cm/sec, $0.001 \leq S \leq 0.01$, and $K_r/K_z = 4.93$. These results are very close to the parameter estimated by interpreting pumping test data (Section 5.3). The aquifer hydraulic parameters estimated through DFT are also presented in Table 5-7.

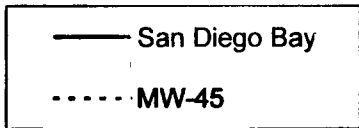
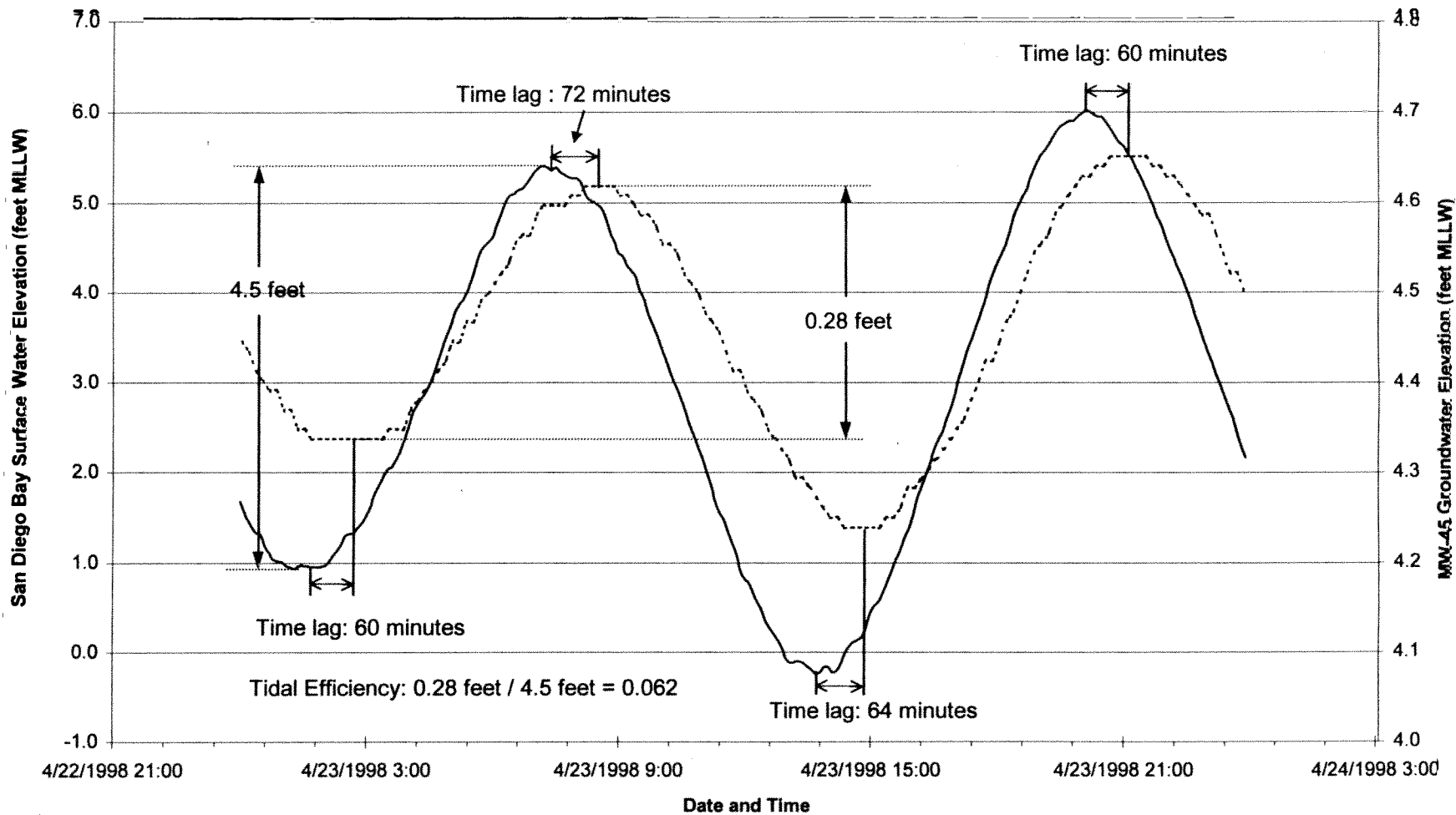

NAS NORTH ISLAND SITE 9
 NoVOCs™ HYDROGEOLOGICAL INVESTIGATION

FIGURE 5-1
WATER LEVEL COMPARISON BETWEEN
SAN DIEGO BAY AND
OBSERVATION WELL MW45

 Tetra Tech EM Inc.

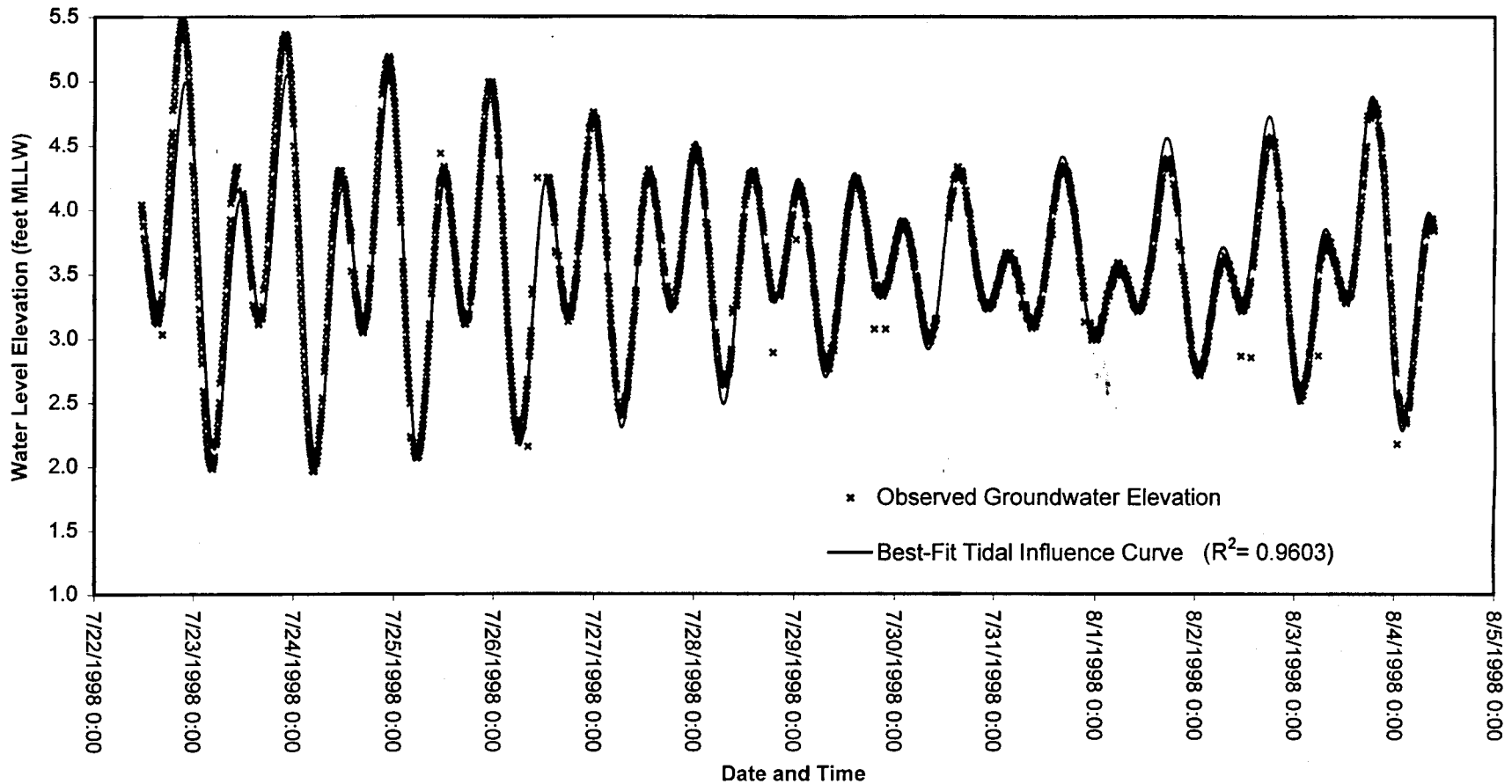

NAS NORTH ISLAND SITE 9
 NoVOCs™ HYDROGEOLOGICAL INVESTIGATION

FIGURE 5-2
 OBSERVED GROUNDWATER ELEVATION AND
 BEST-FIT TIDAL INFLUENCE CURVE
 FOR WELL MW20

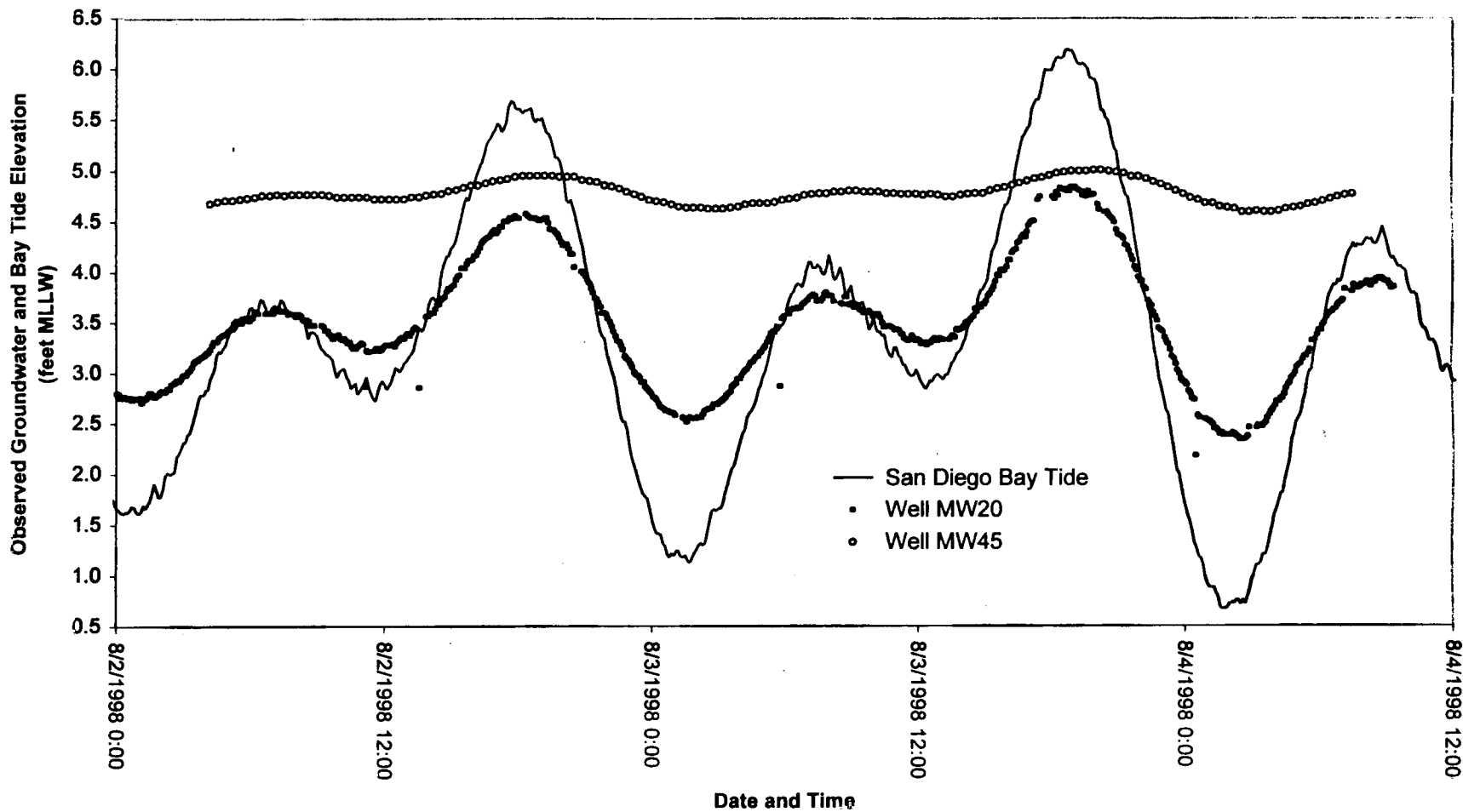

NAS NORTH ISLAND SITE 9
 NoVOCs™ HYDROGEOLOGICAL INVESTIGATION

FIGURE 5-3
 OBSERVED WATER LEVEL COMPARISON
 AMONG
 BAY TIDE, MW20 AND MW45

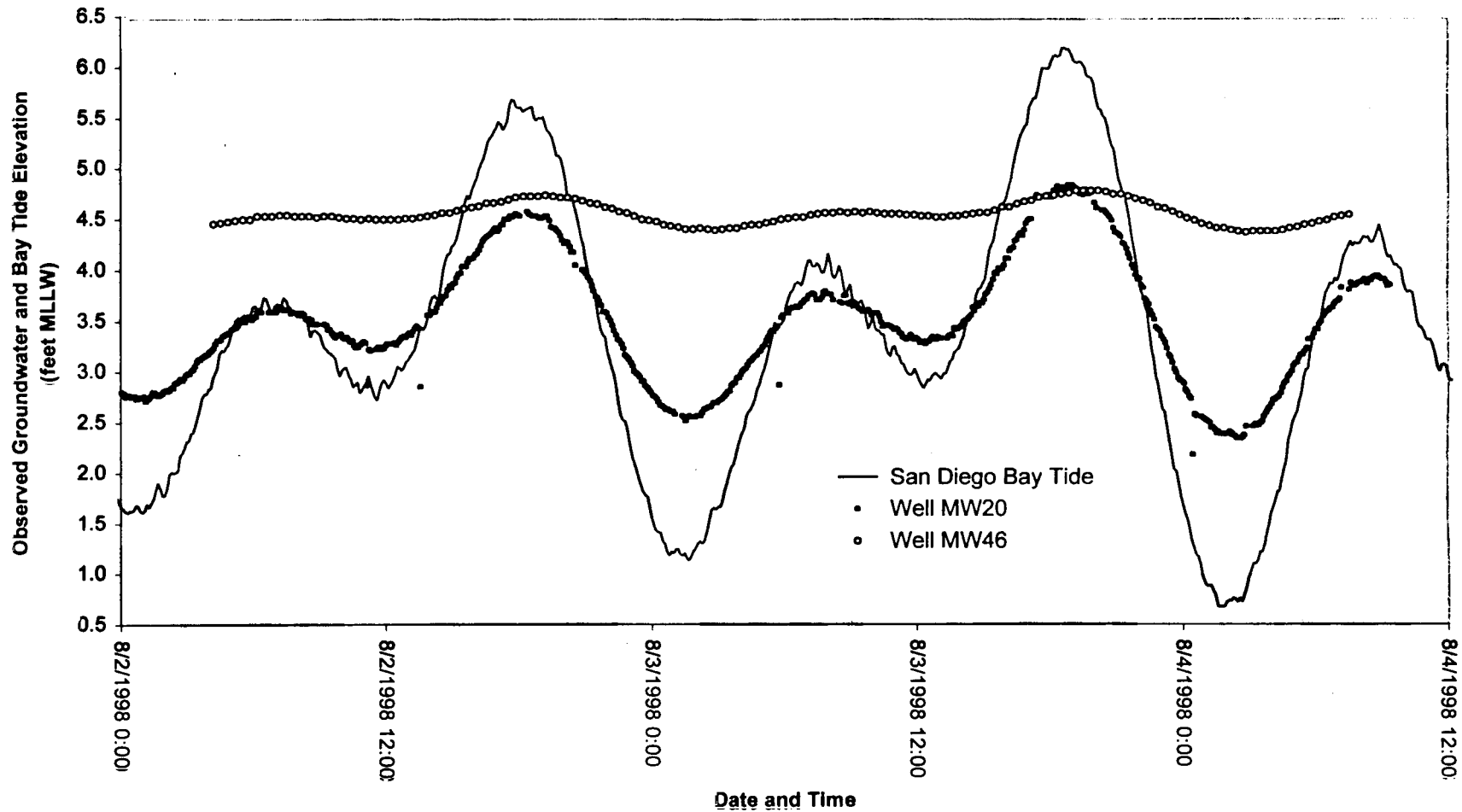

NAS NORTH ISLAND SITE 9
 NoVOCs™ HYDROGEOLOGICAL INVESTIGATION

FIGURE 5-4
 OBSERVED WATER LEVEL COMPARISON
 AMONG
 BAY TIDE, MW20 AND MW46

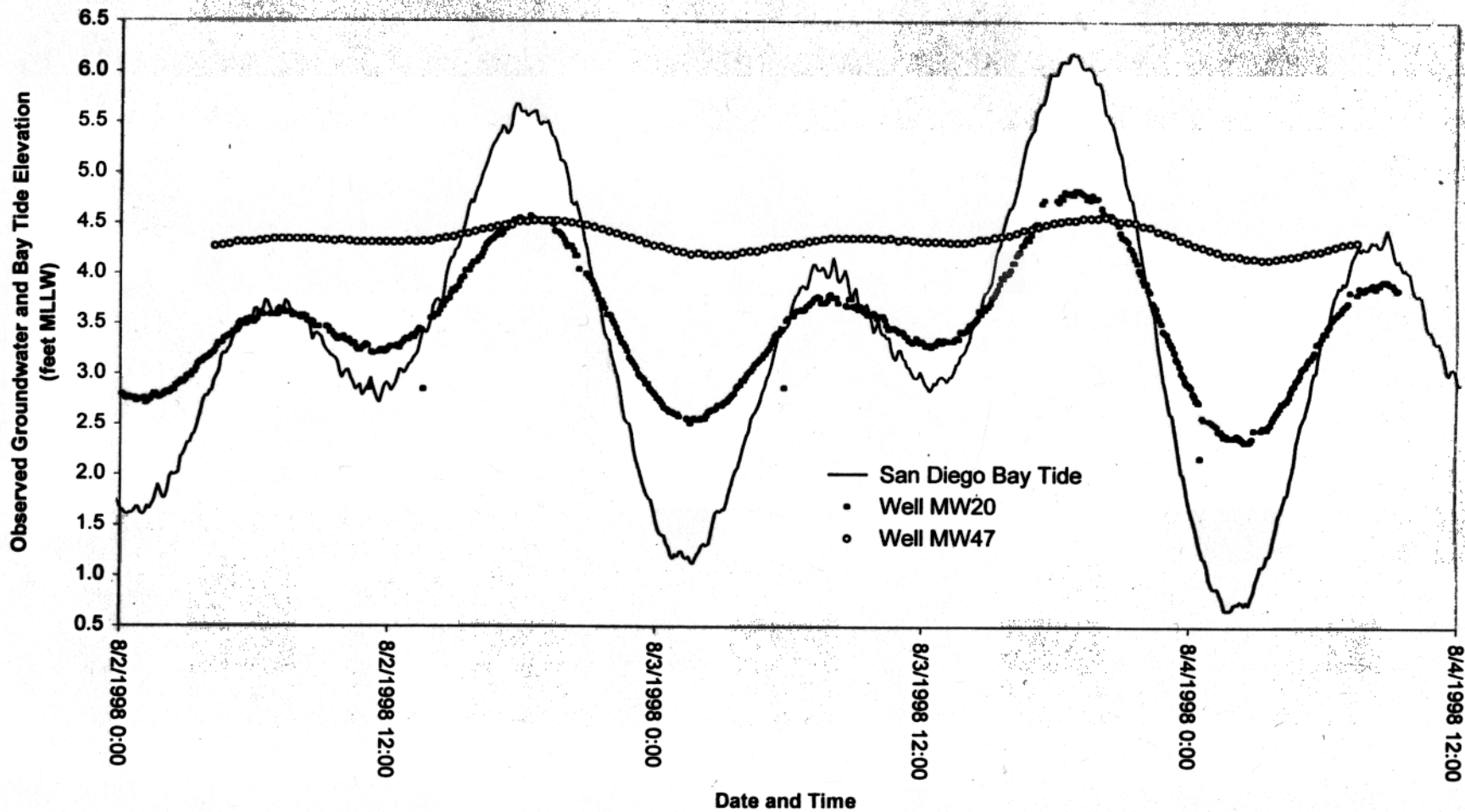

NAS NORTH ISLAND SITE 9
 NoVOCs™ HYDROGEOLOGICAL INVESTIGATION

FIGURE 5-5
 OBSERVED WATER LEVEL COMPARISON
 AMONG
 BAY TIDE, MW20 AND MW47

 Tetra Tech EM Inc.

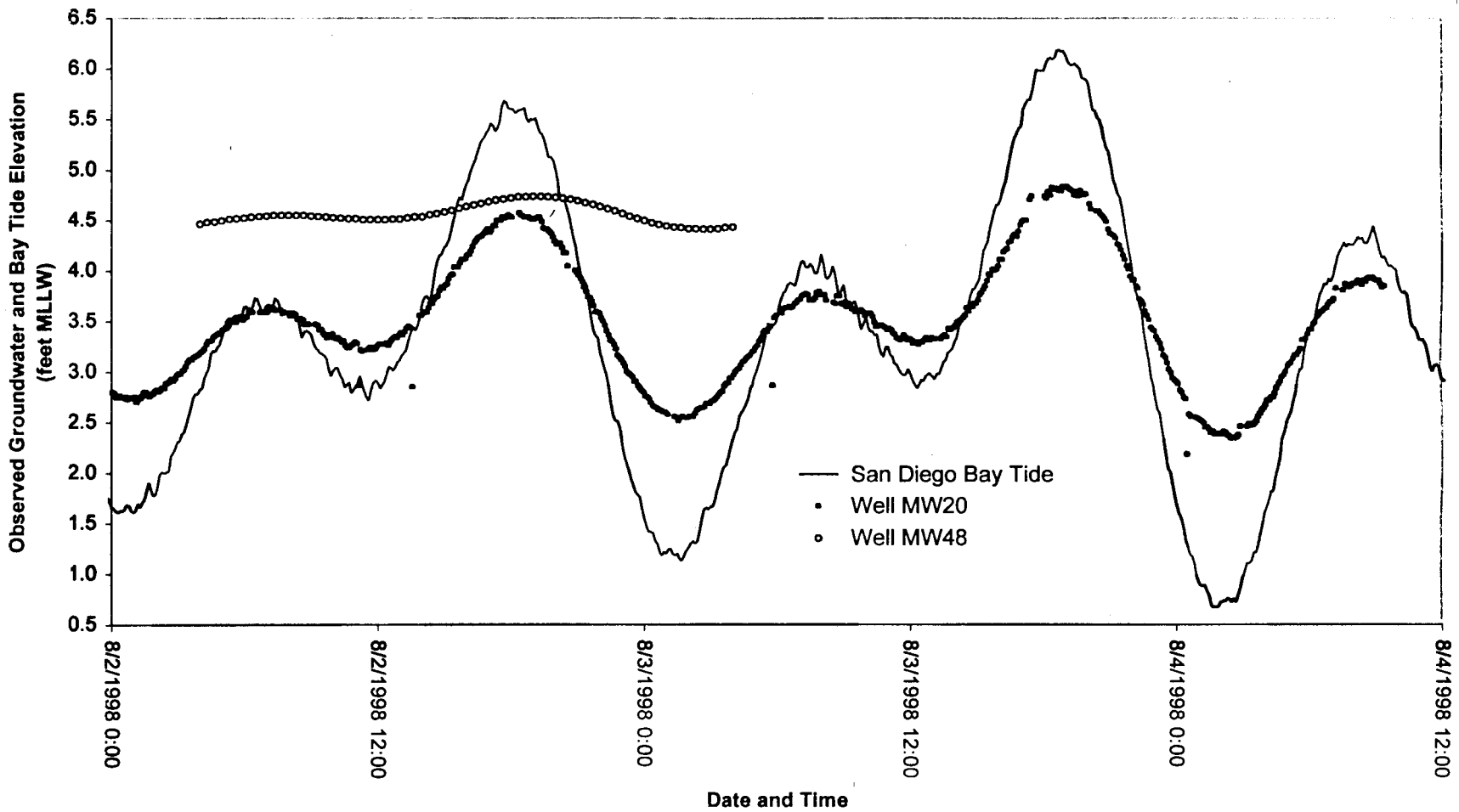

NAS NORTH ISLAND SITE 9
 NoVOCs™ HYDROGEOLOGICAL INVESTIGATION

FIGURE 5-6
 OBSERVED WATER LEVEL COMPARISON
 AMONG
 BAY TIDE, MW20 AND MW48

 Tetra Tech EM Inc.

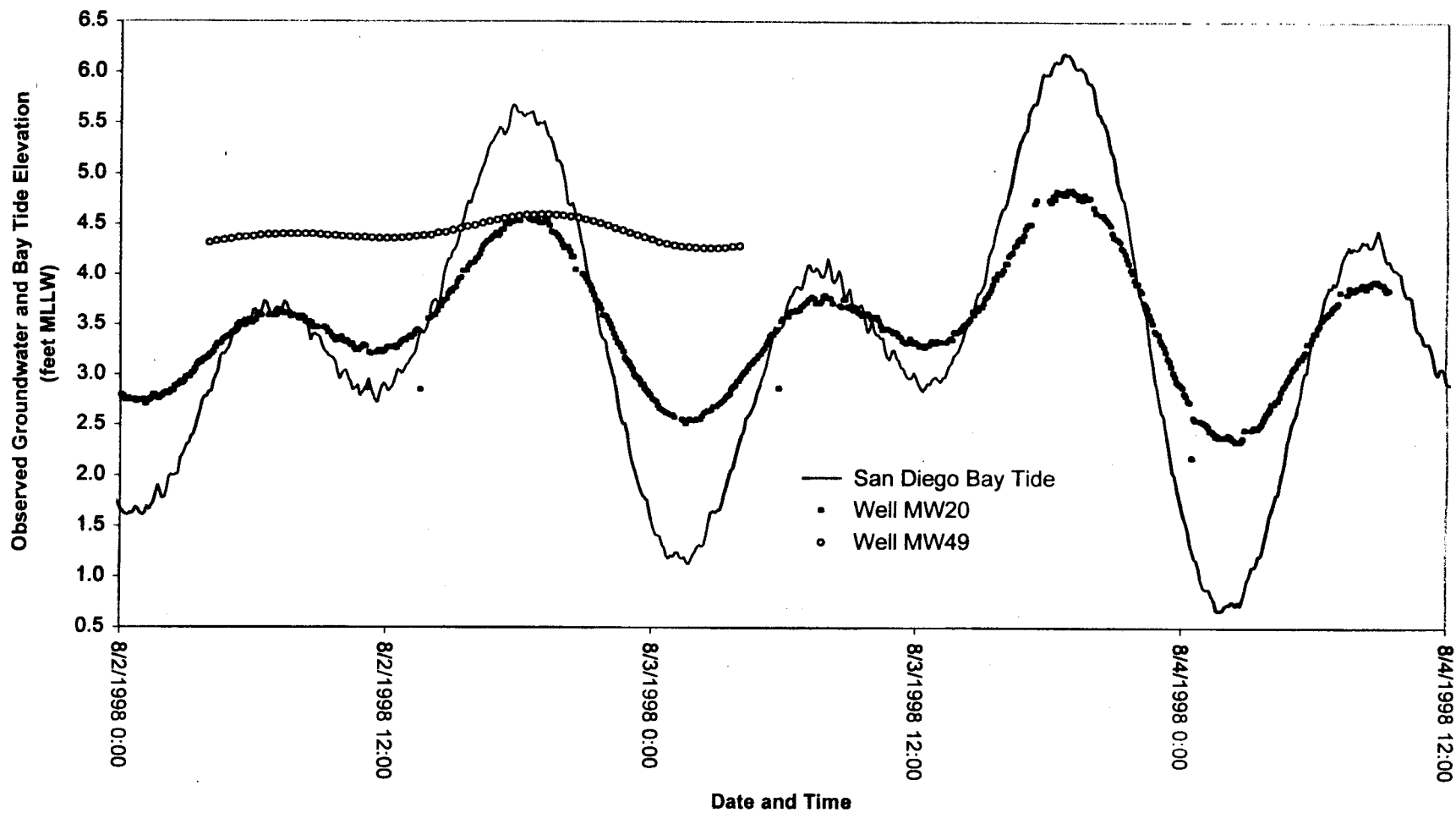

NAS NORTH ISLAND SITE 9
 NoVOCs™ HYDROGEOLOGICAL INVESTIGATION

FIGURE 5-7
 OBSERVED WATER LEVEL COMPARISON
 AMONG
 BAY TIDE, MW20 AND MW49

 Tetra Tech EM Inc.

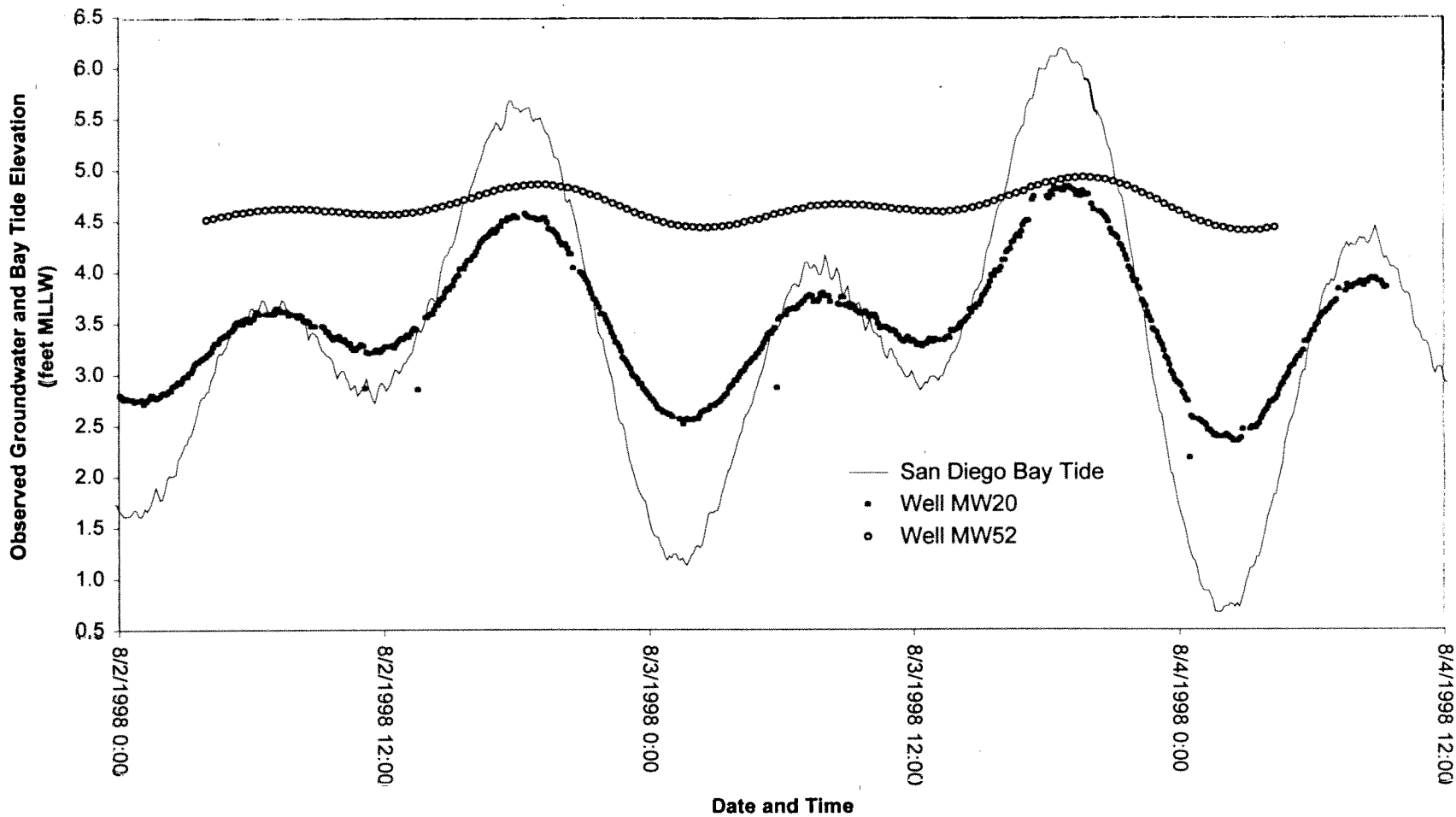

NAS NORTH ISLAND SITE 9
 NoVOCs™ HYDROGEOLOGICAL INVESTIGATION

FIGURE 5-8
 OBSERVED WATER LEVEL COMPARISON
 AMONG
 BAY TIDE, MW20 AND MW52

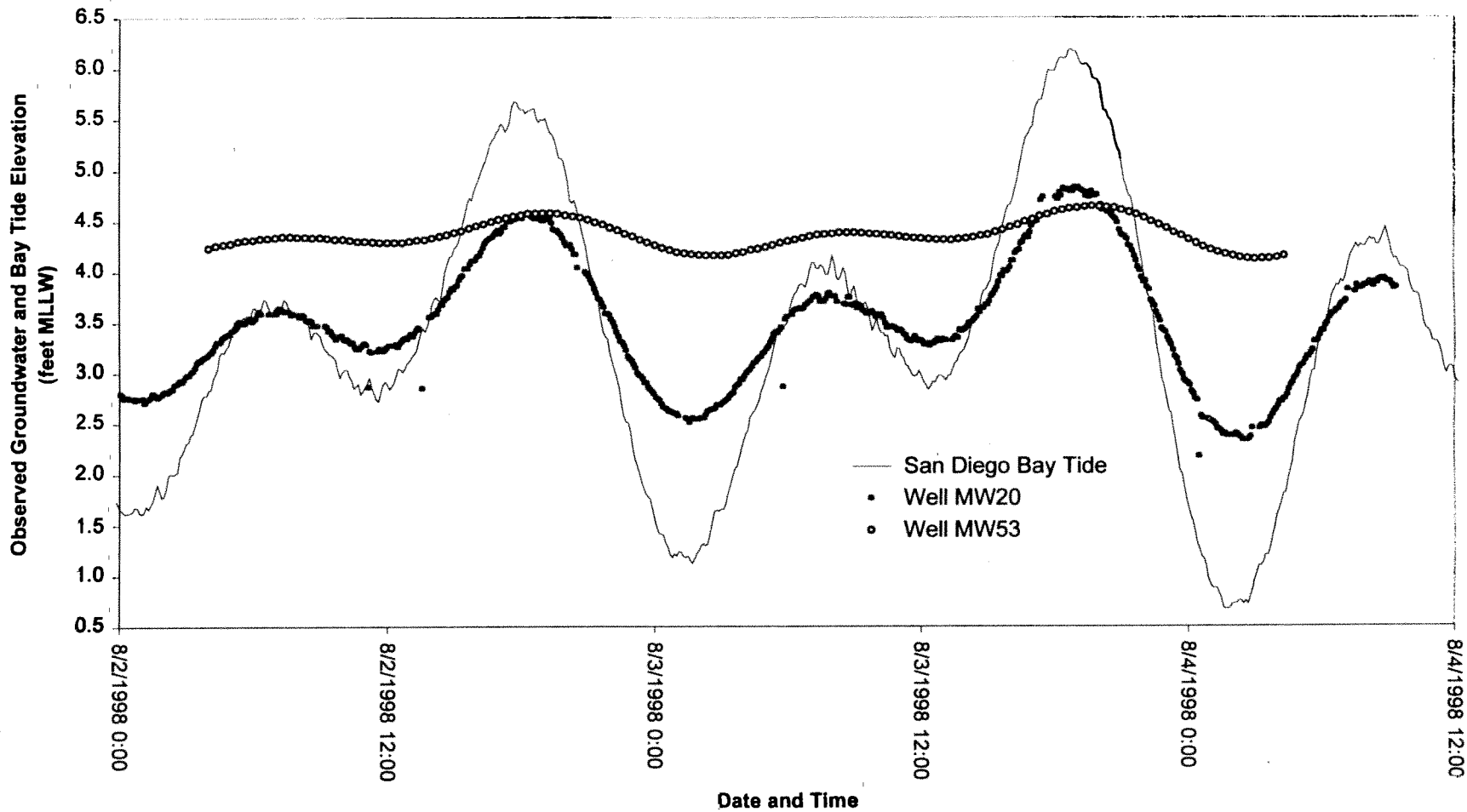

NAS NORTH ISLAND SITE 9
 NoVOCs™ HYDROGEOLOGICAL INVESTIGATION

FIGURE 5-9
 OBSERVED WATER LEVEL COMPARISON
 AMONG
 BAY TIDE, MW20 AND MW53

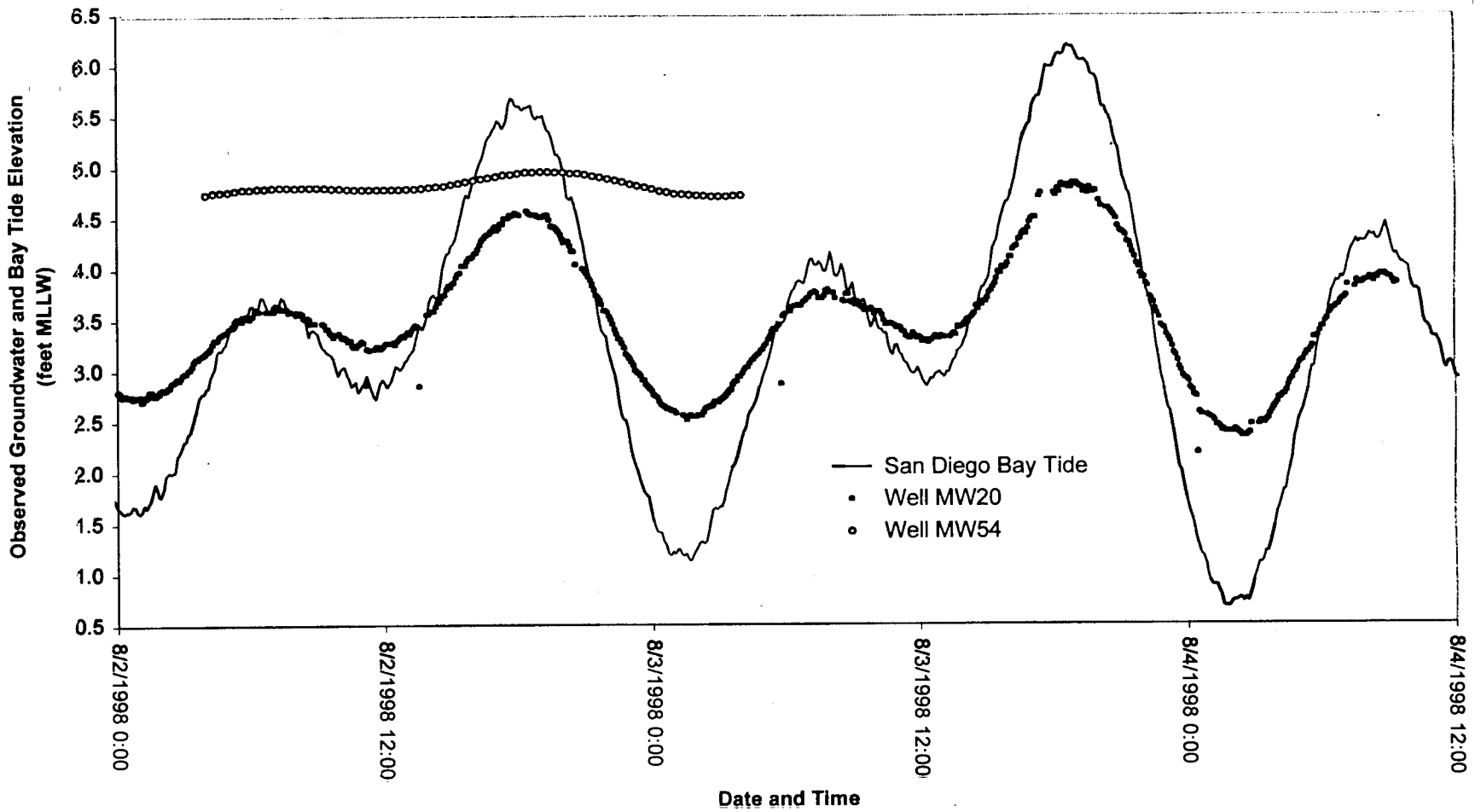

NAS NORTH ISLAND SITE 9
 NoVOCs™ HYDROGEOLOGICAL INVESTIGATION

FIGURE 5-10
 OBSERVED WATER LEVEL COMPARISON
 AMONG
 BAY TIDE, MW20 AND MW54

 Tetra Tech EM Inc.

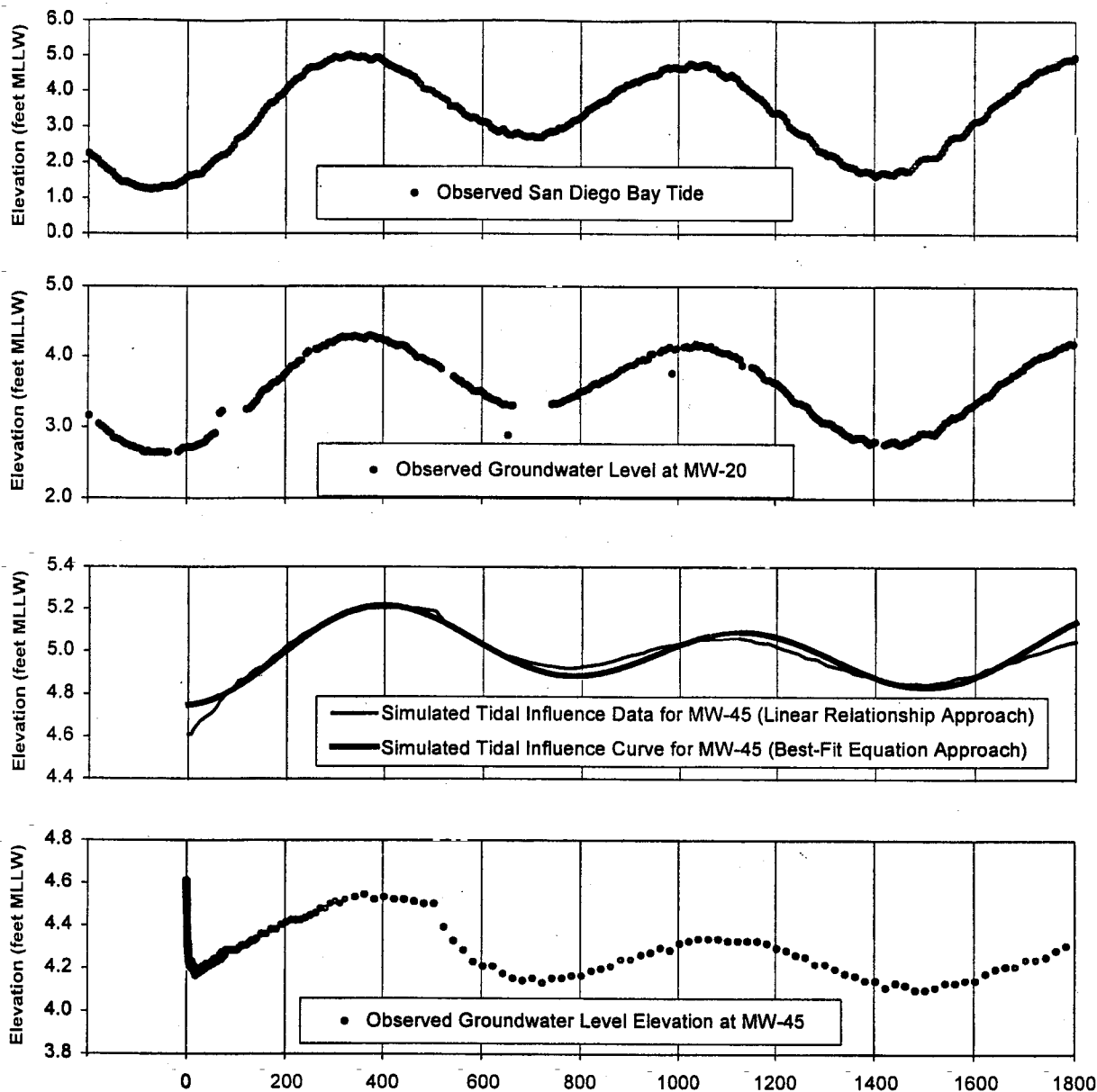

NAS NORTH ISLAND SITE 9
 NoVOCs™ HYDROGEOLOGICAL INVESTIGATION

FIGURE 5-11
 OBSERVED AND SIMULATED WATER LEVEL
 COMPARISON AMONG BAY TIDE, MW20, MW45
 DURING THE PUMPING TEST
 (Upper Aquifer Zone Constant Rate Pumping Test)



Tetra Tech EM Inc.

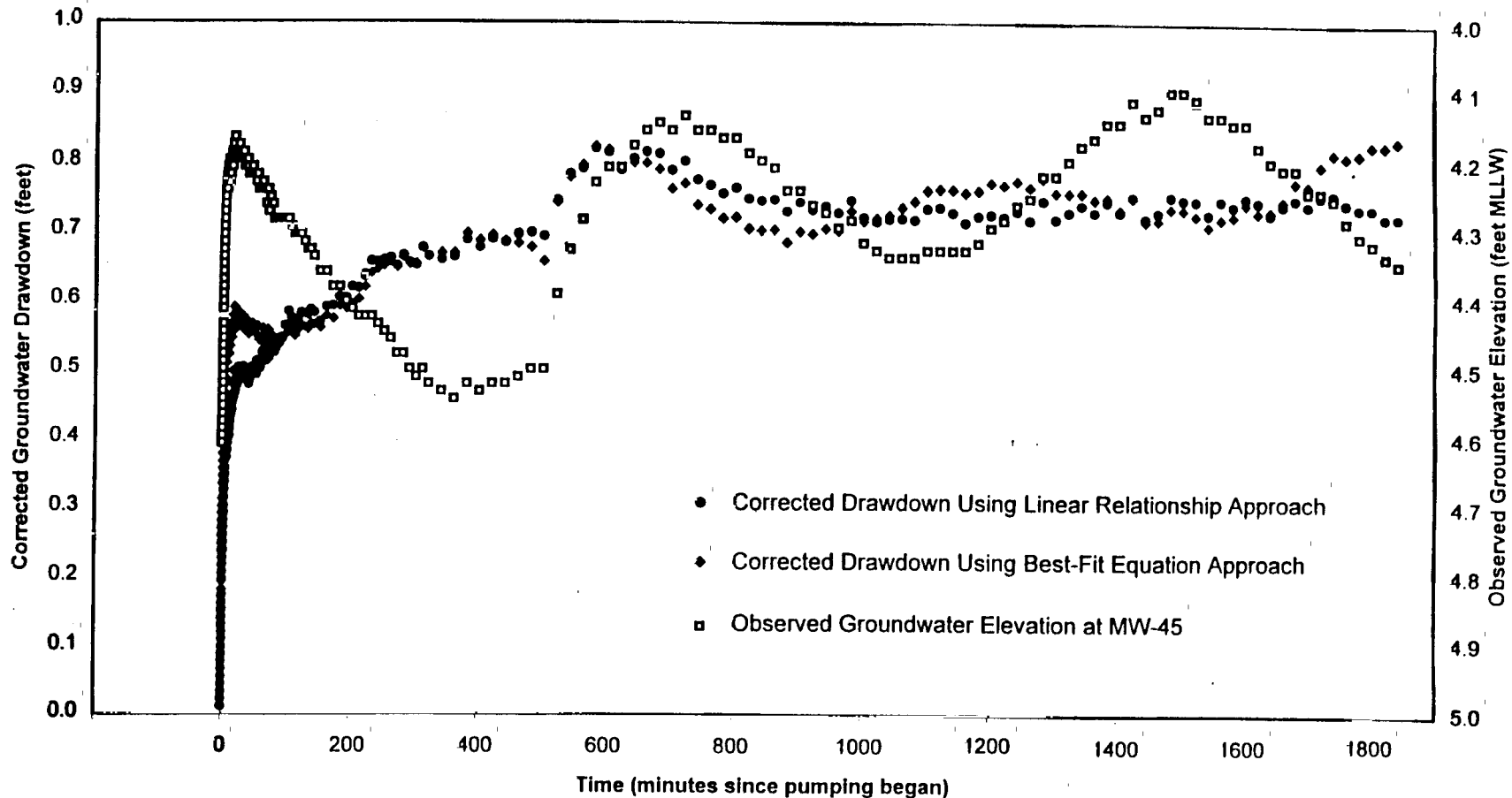

NAS NORTH ISLAND SITE 9
 NoVOCs™ HYDROGEOLOGICAL INVESTIGATION

FIGURE 5-12
 OBSERVED AND CORRECTED GROUNDWATER
 DRAWDOWN AT WELL MW45
 (Upper Aquifer Zone Constant Rate Pumping Test)

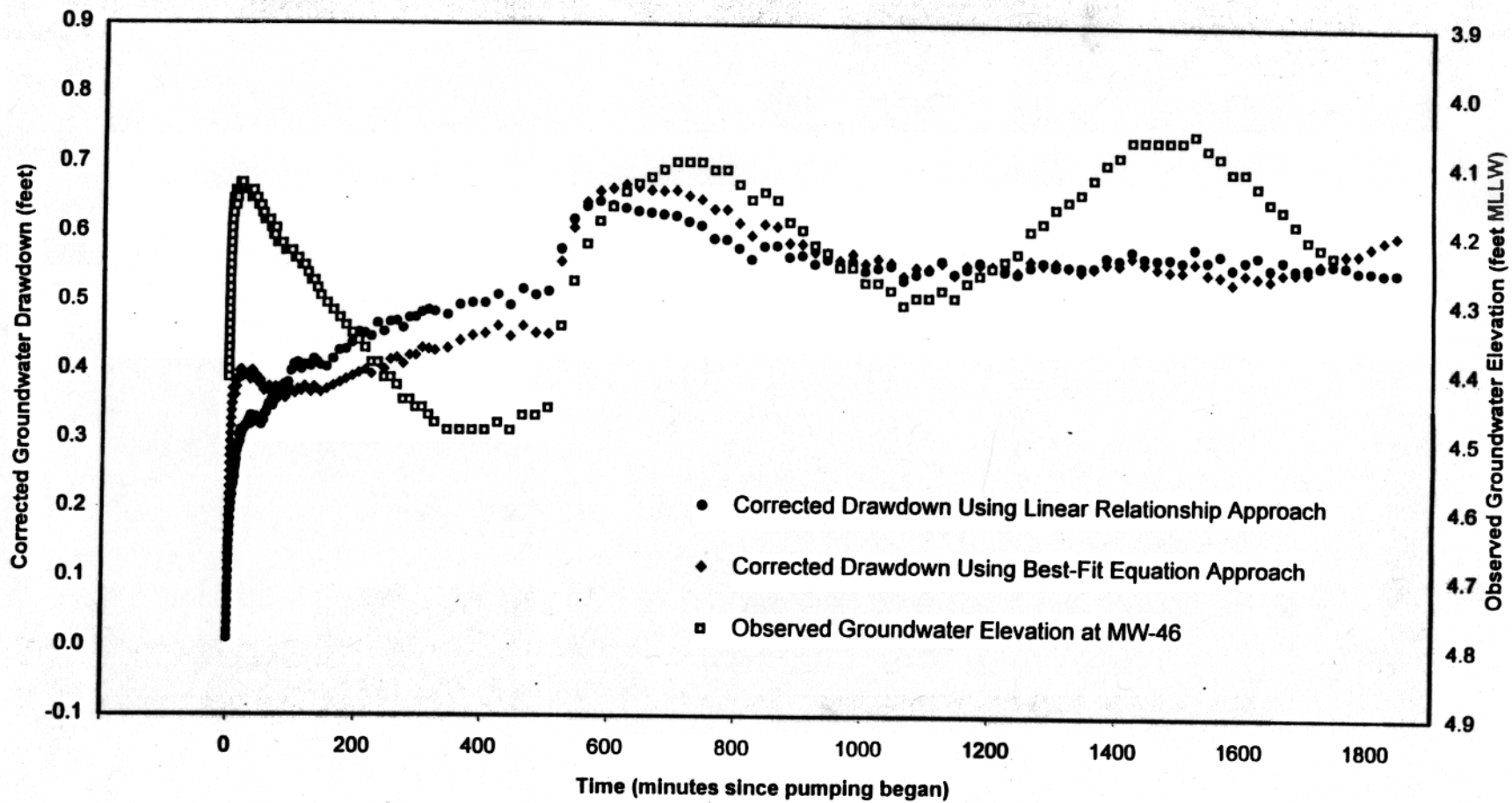

NAS NORTH ISLAND SITE 9
 NoVOCs™ HYDROGEOLOGICAL INVESTIGATION

FIGURE 5-13
 OBSERVED AND CORRECTED GROUNDWATER
 DRAWDOWN AT WELL MW46
 (Upper Aquifer Zone Constant Rate Pumping Test)

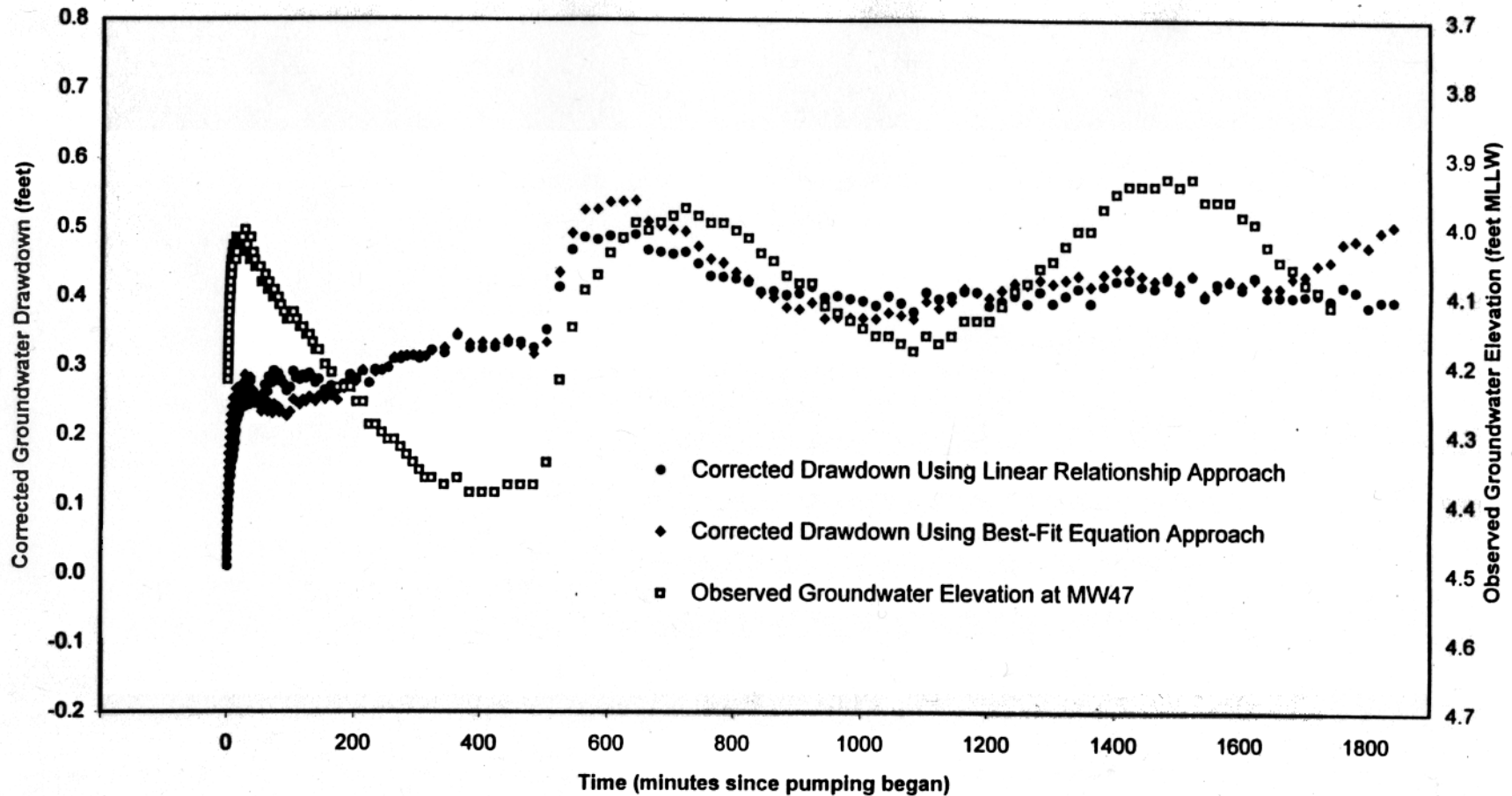

NAS NORTH ISLAND SITE 9
 NoVOCs™ HYDROGEOLOGICAL INVESTIGATION

FIGURE 5-14
 OBSERVED AND CORRECTED GROUNDWATER
 DRAWDOWN AT WELL MW47
 (Upper Aquifer Zone Constant Rate Pumping Test)

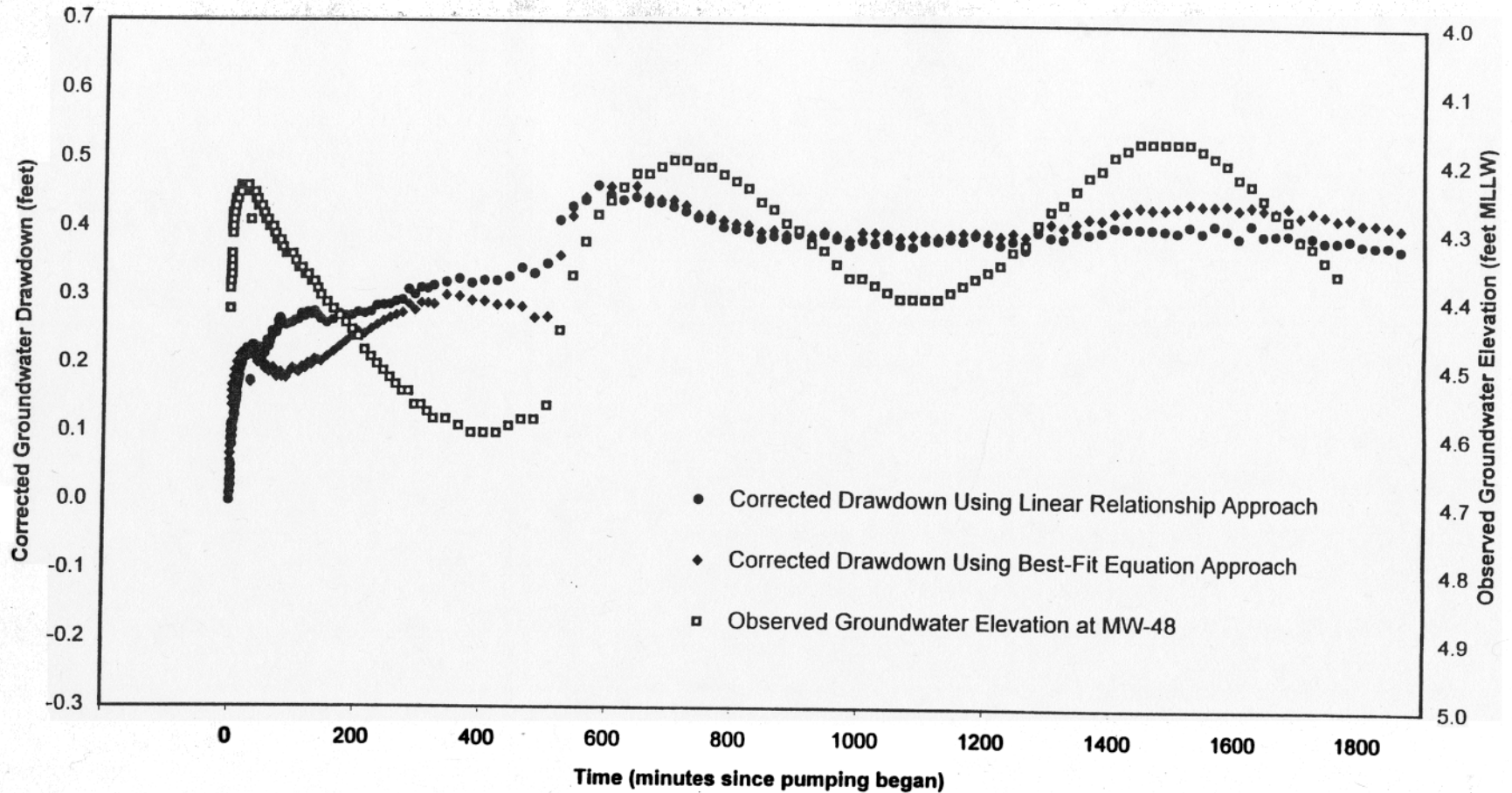

NAS NORTH ISLAND SITE 9
 NoVOCs™ HYDROGEOLOGICAL INVESTIGATION

FIGURE 5-15
 OBSERVED AND CORRECTED GROUNDWATER
 DRAWDOWN AT WELL MW48
 (Upper Aquifer Zone Constant Rate Pumping Test)

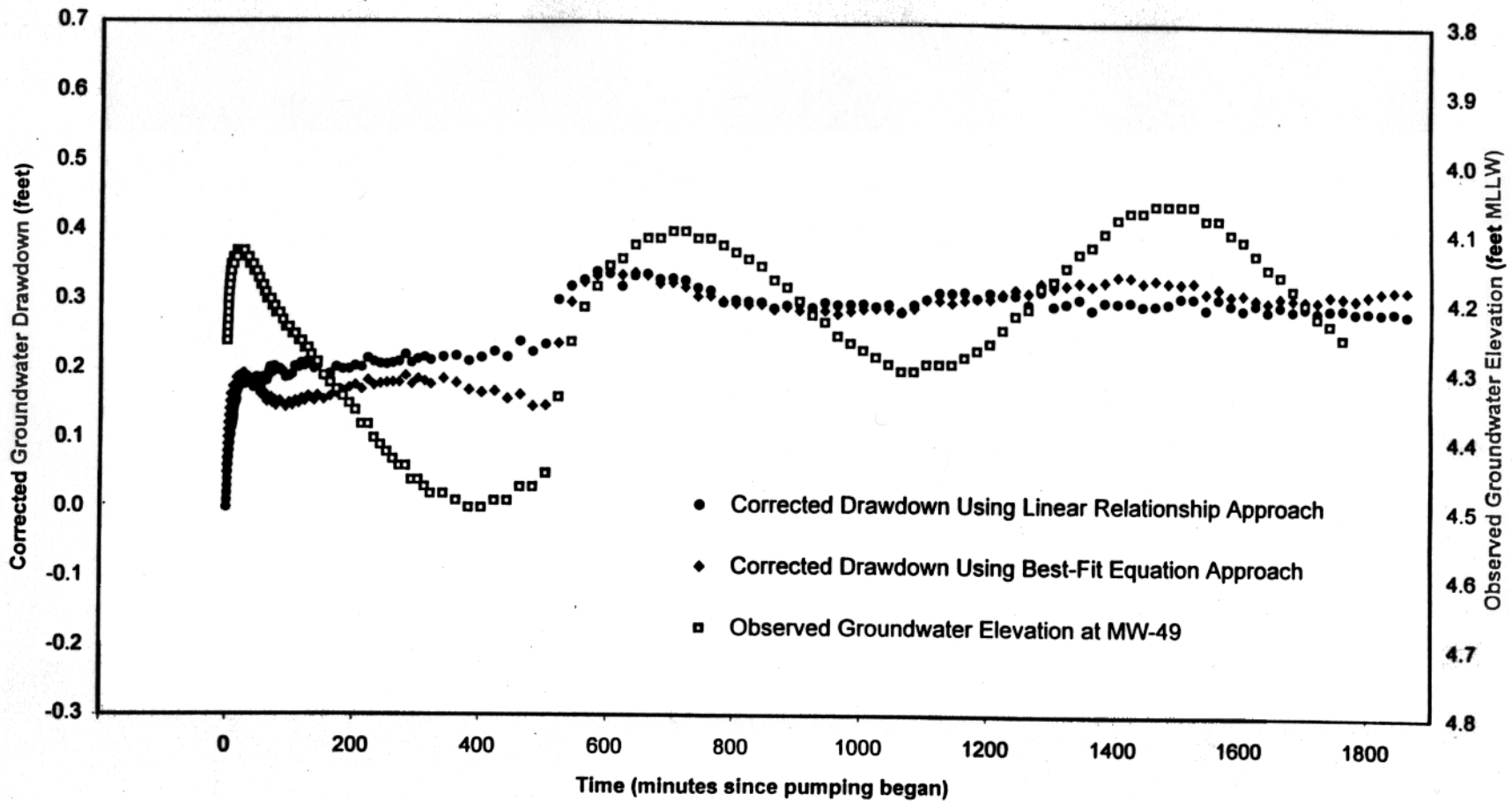

NAS NORTH ISLAND SITE 9
 NoVOCs™ HYDROGEOLOGICAL INVESTIGATION

FIGURE 5-16
 OBSERVED AND CORRECTED GROUNDWATER
 DRAWDOWN AT WELL MW49
 (Upper Aquifer Zone Constant Rate Pumping Test)

 Tetra Tech EM Inc.

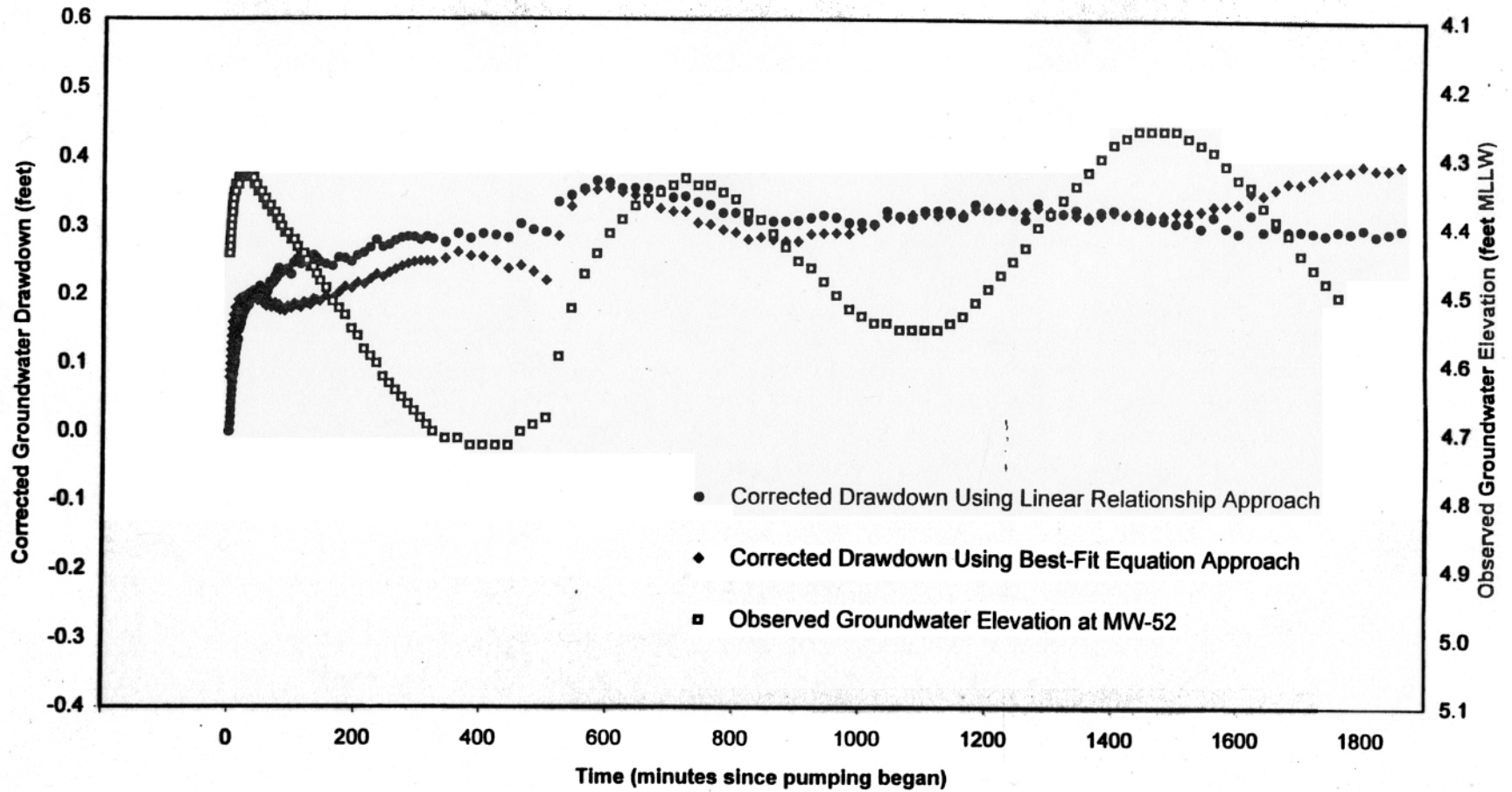

NAS NORTH ISLAND SITE 9
 NoVOCs™ HYDROGEOLOGICAL INVESTIGATION

FIGURE 5-17
 OBSERVED AND CORRECTED GROUNDWATER
 DRAWDOWN AT WELL MW52
 (Upper Aquifer Zone Constant Rate Pumping Test)

 Tetra Tech EM Inc.

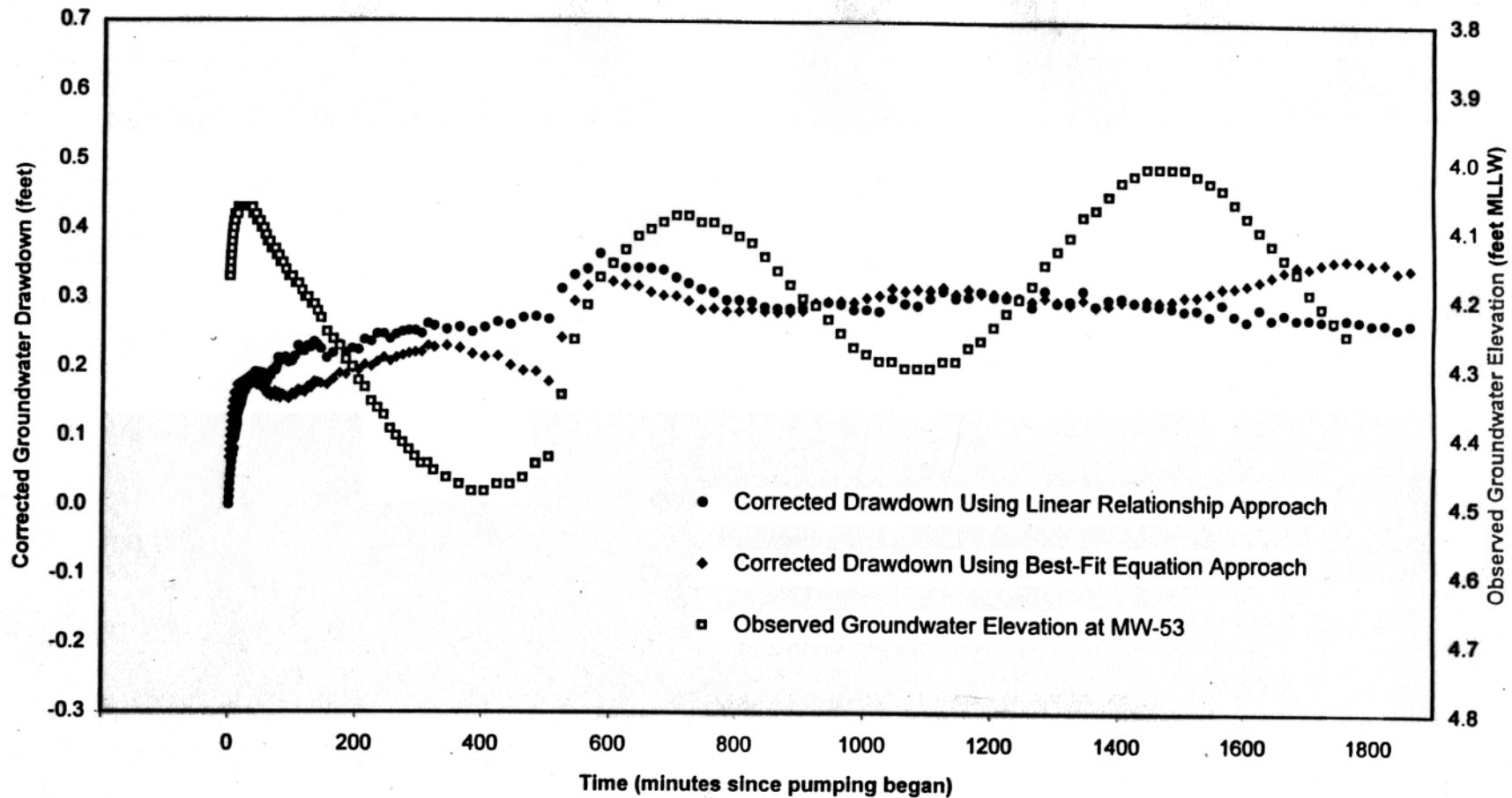

NAS NORTH ISLAND SITE 9
 NoVOCs™ HYDROGEOLOGICAL INVESTIGATION

FIGURE 5-18
 OBSERVED AND CORRECTED GROUNDWATER
 DRAWDOWN AT WELL MW53
 (Upper Aquifer Zone Constant Rate Pumping Test)

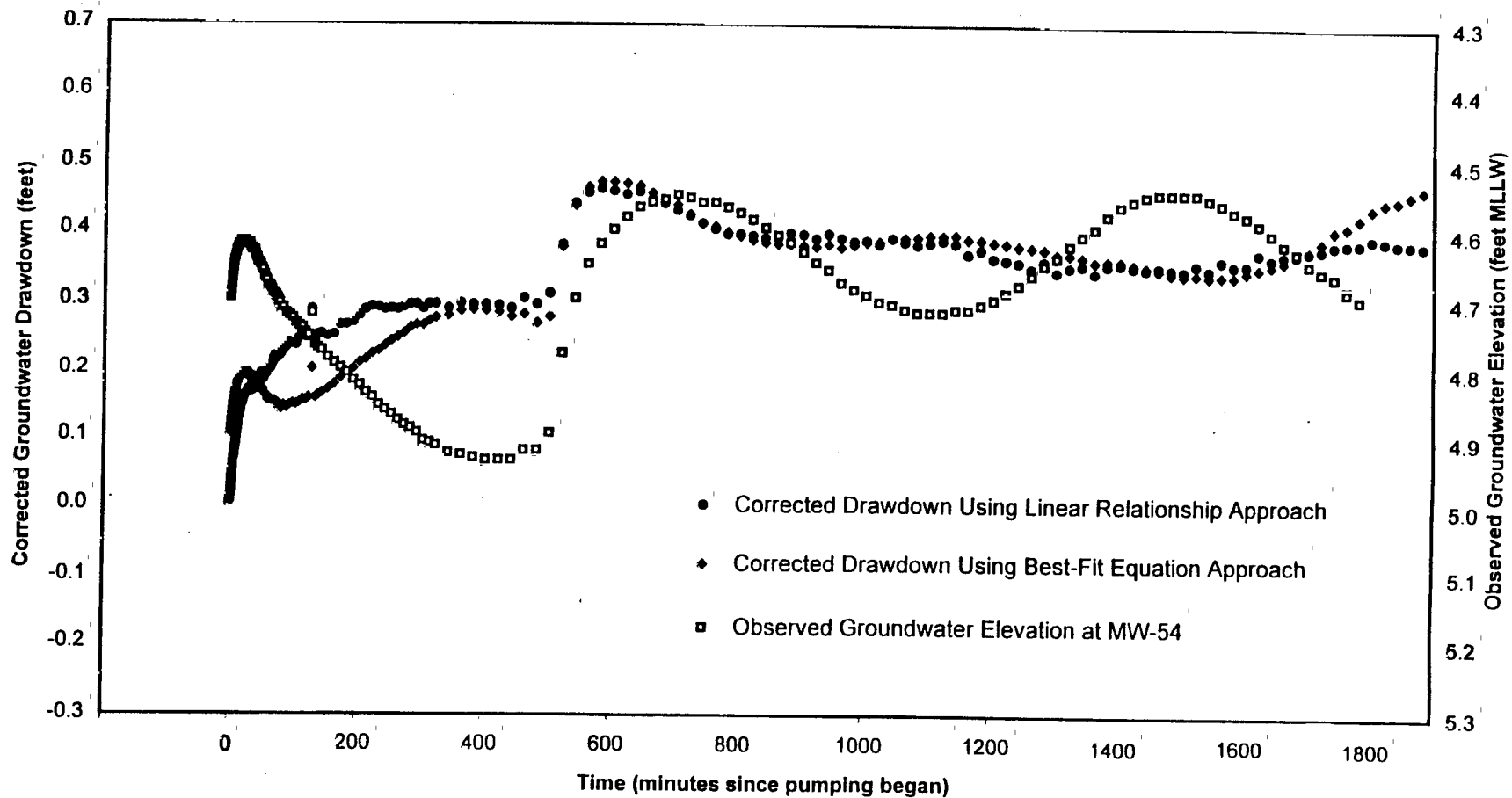

NAS NORTH ISLAND SITE 9
 NoVOCs™ HYDROGEOLOGICAL INVESTIGATION

FIGURE 5-19
 OBSERVED AND CORRECTED GROUNDWATER
 DRAWDOWN AT WELL MW54
 (Upper Aquifer Zone Constant Rate Pumping Test)

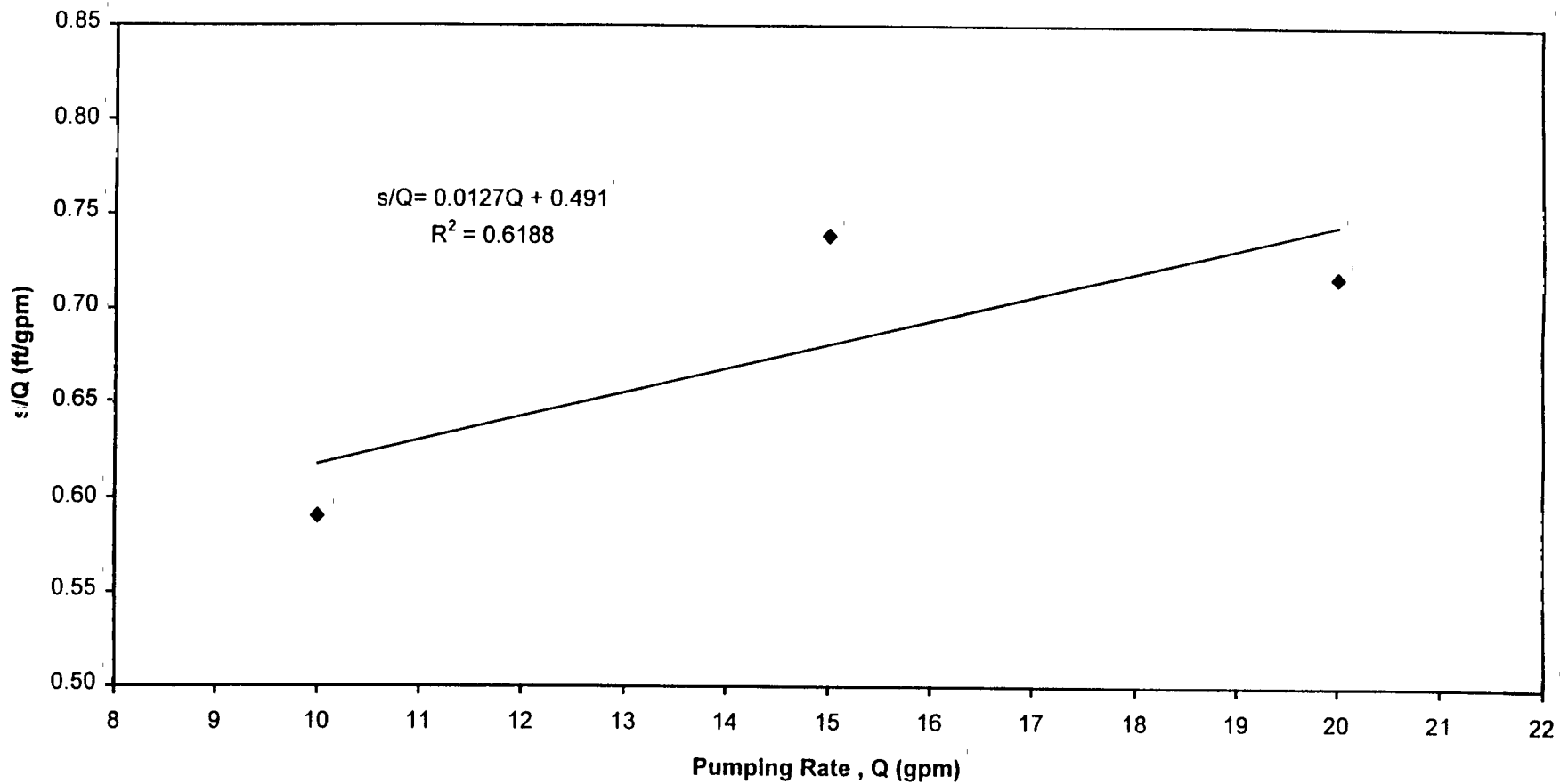

NAS NORTH ISLAND SITE 9
NoVOCs™ HYDROGEOLOGICAL INVESTIGATION

FIGURE 5-20
s/Q vs. Q PLOTS

(Upper Aquifer Zone Step-drawdown Test)

 Tetra Tech EM Inc.

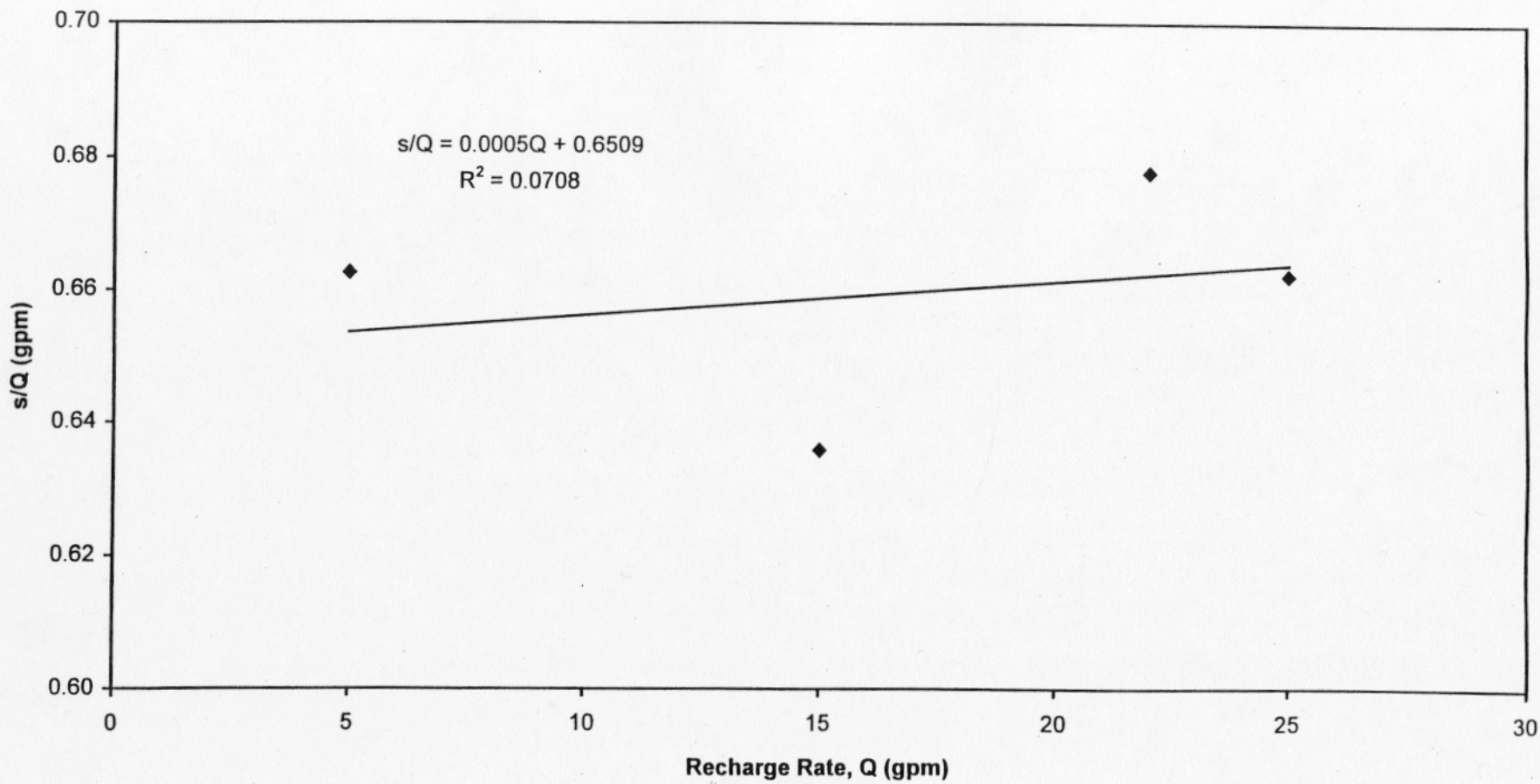

NAS NORTH ISLAND SITE 9
 NoVOCs™ HYDROGEOLOGICAL INVESTIGATION

FIGURE 5-21
 s/Q vs. Q PLOTS

(Upper Aquifer Zone Injection Test)

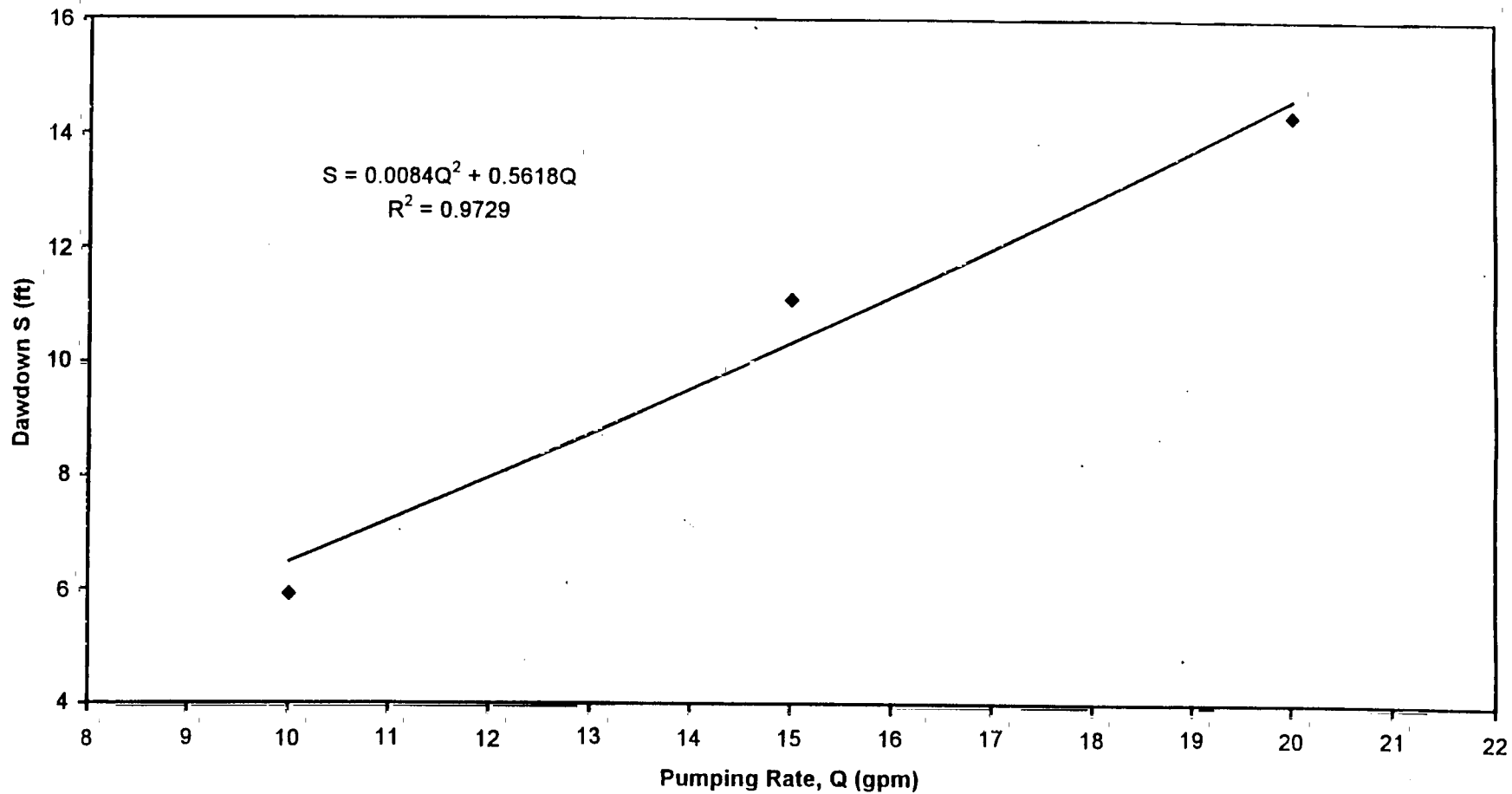

NAS NORTH ISLAND SITE 9
 NoVOCs™ HYDROGEOLOGICAL INVESTIGATION

FIGURE 5-22
 MAXIMUM DRAWDOWN vs. PUMPING RATE AND
 THE BEST FIT EQUATION
 (Upper Aquifer Zone Step-drawdown Test)

 Tetra Tech EM Inc.

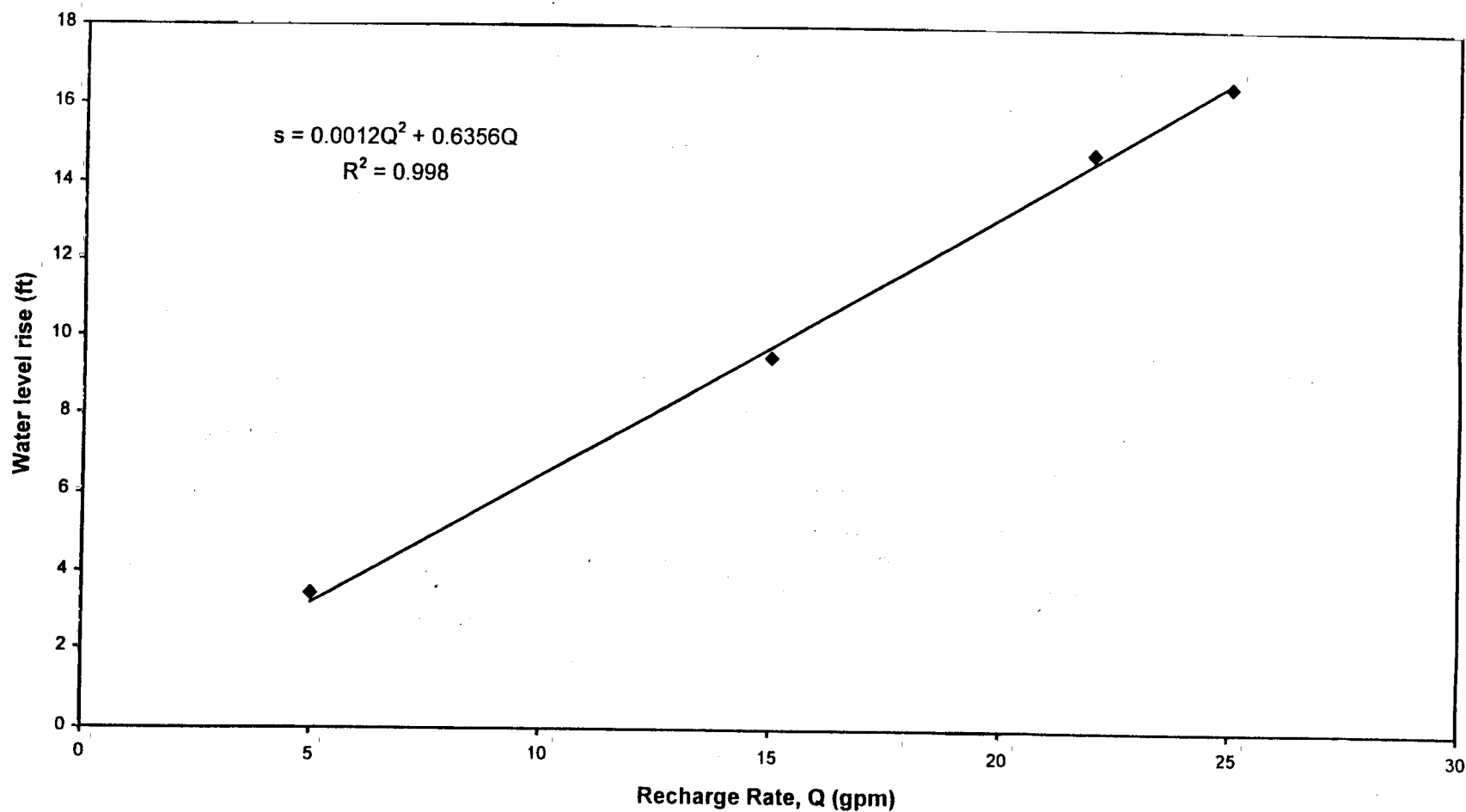

NAS NORTH ISLAND SITE 9
 NoVOCs™ HYDROGEOLOGICAL INVESTIGATION

FIGURE 5-23
 MAXIMUM WATER LEVEL RISE vs. RECHARGE
 RATE AND THE BEST FIT EQUATION
 (Upper Aquifer Zone Injection Test)

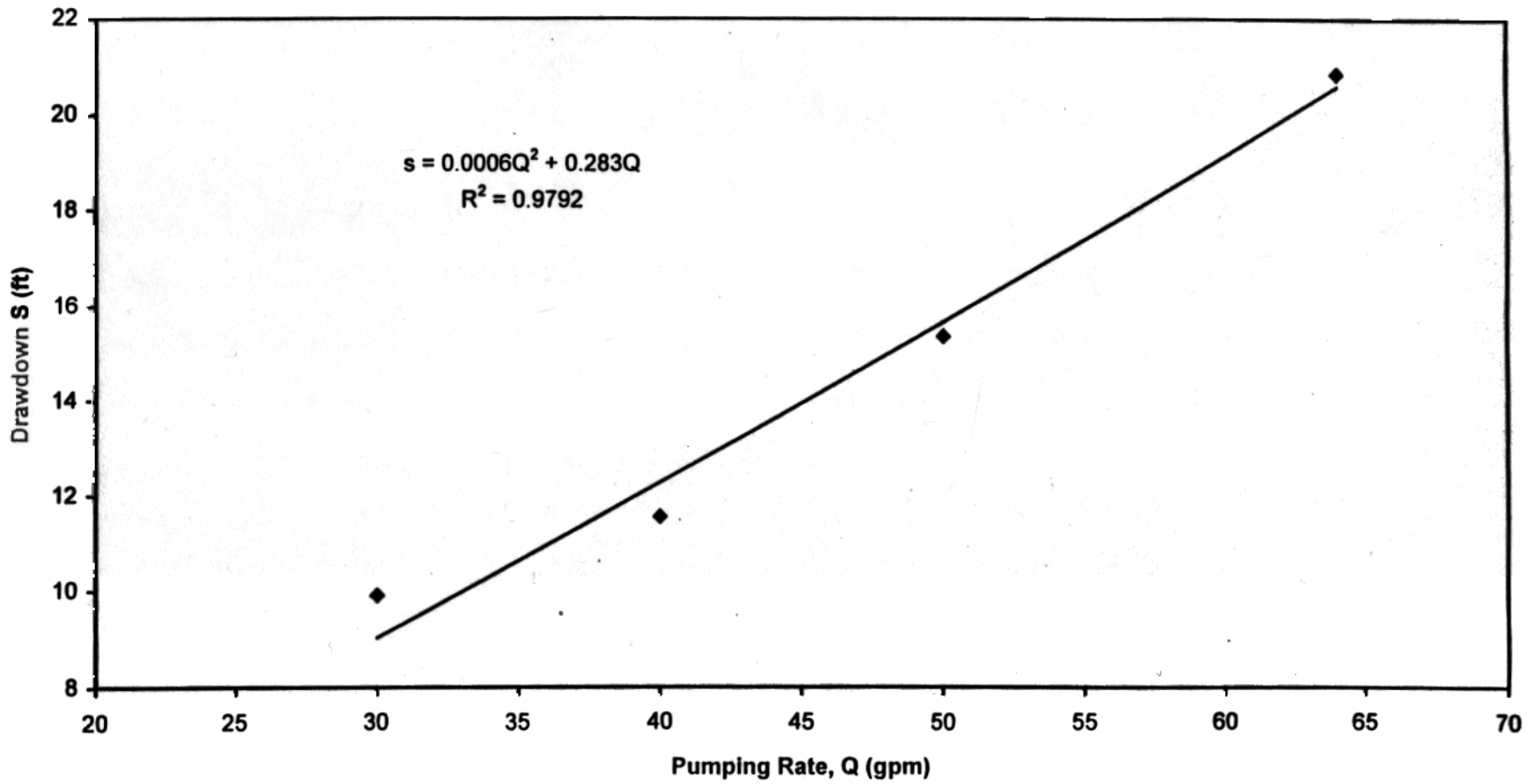

NAS NORTH ISLAND SITE 9
 NoVOCs™ HYDROGEOLOGICAL INVESTIGATION

FIGURE 5-24
 MAXIMUM DRAWDOWN vs. PUMPING RATE AND
 THE BEST FIT EQUATION
 (Lower Aquifer Zone Step-drawdown Test)

 Tetra Tech EM Inc.

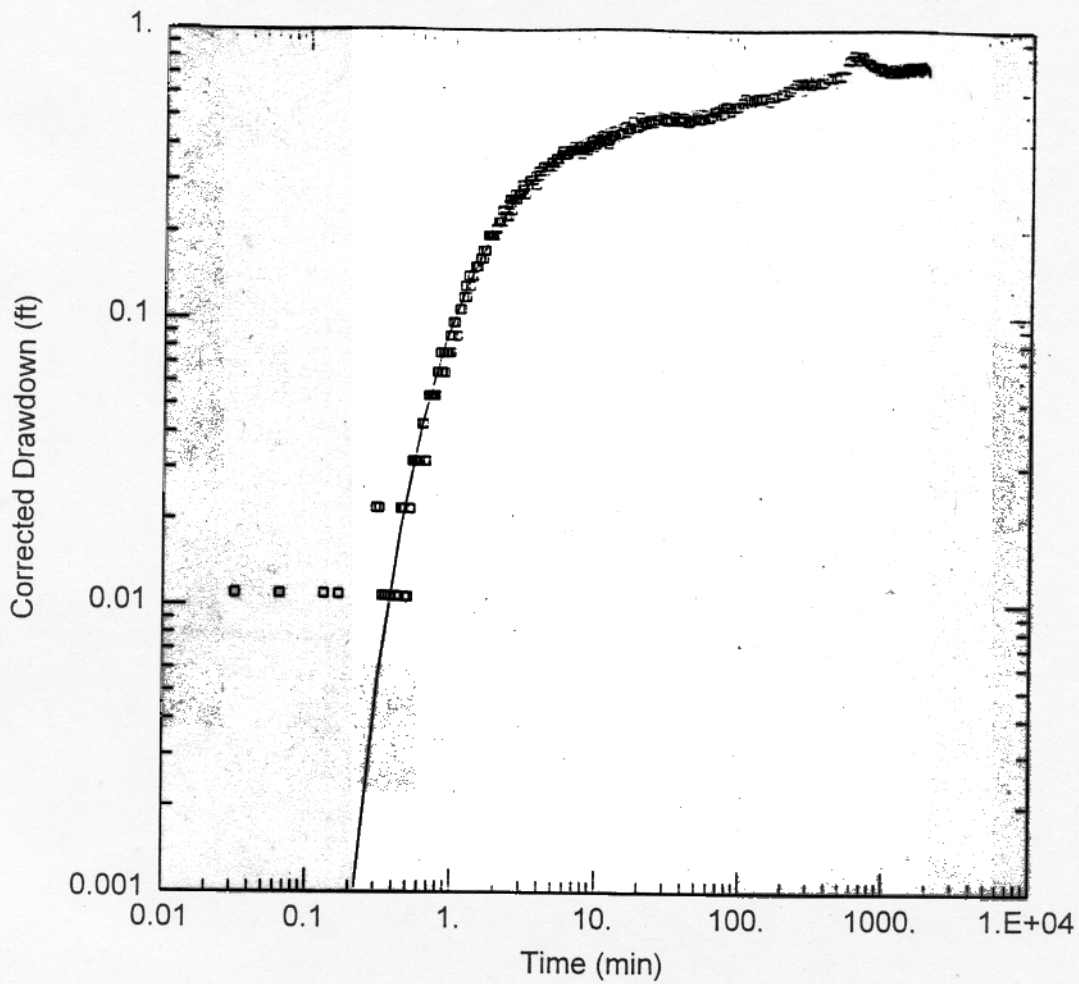

NAS NI SITE 9 PUMPING TEST DATA - MW45

Data Set: S:\NOVOCs\WORKIN~2\CONSTA~2\MW45-88.AQT

Date: 02/12/99

Time: 17:47:28

SOLUTION

Aquifer Model: Unconfined

Solution Method: Neuman

$T = 2450. \text{ ft}^2/\text{day}$

$S = 0.008428$

$Sy = 0.1201$

$\beta = 0.03$

NAS NORTH ISLAND SITE 9
NoVOCs™ HYDROGEOLOGICAL INVESTIGATION

FIGURE 5-25
MW45 DRAWDOWN DATA PLOT
AND TYPE CURVE MATCH
(Upper Aquifer Zone Constant Rate Pumping Test)



Tetra Tech EM Inc.

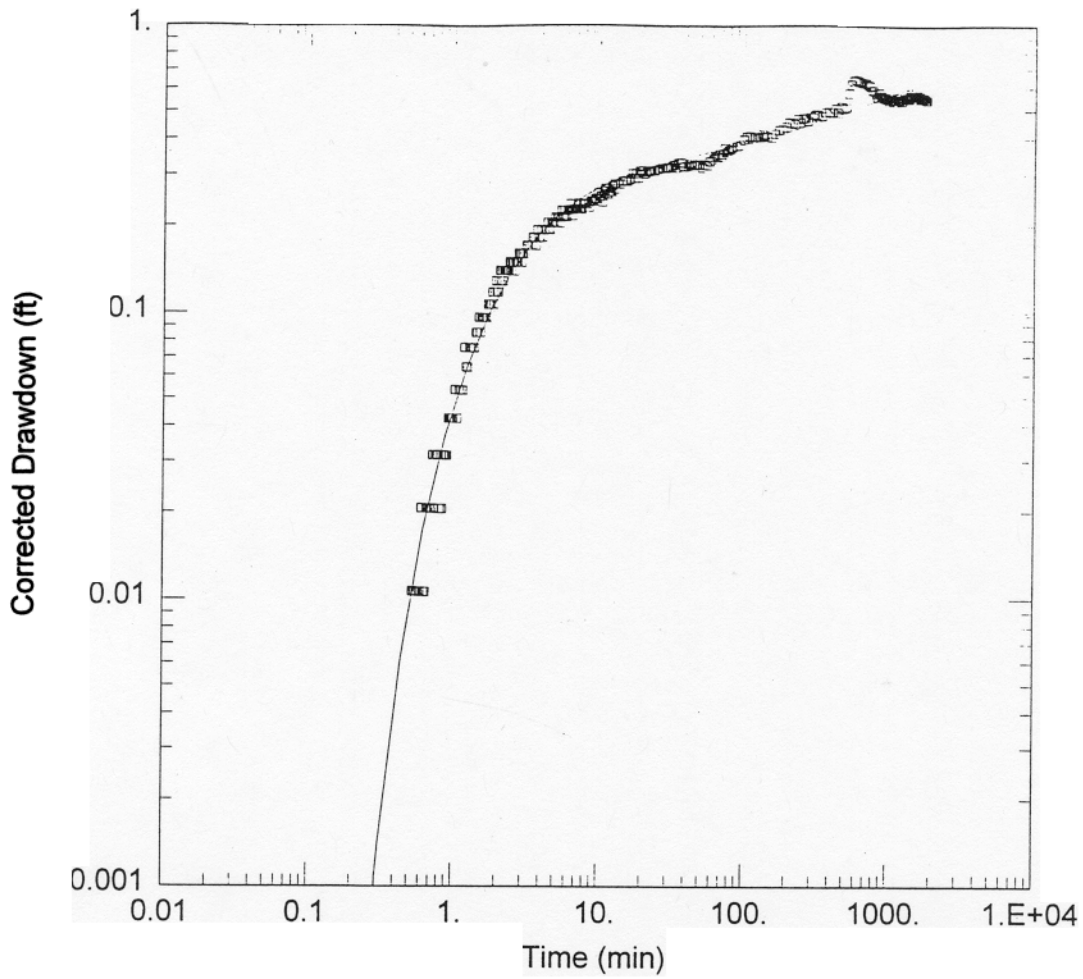

NAS NI SITE 9 PUMPING TEST DATA - MW46

Data Set: S:\NOVOCs\WORKIN~2\CONSTA~2\MW46-88.AQT

Date: 02/12/99

Time: 17:25:35

SOLUTION

Aquifer Model: Unconfined

Solution Method: Neuman

$T = 2722.3 \text{ ft}^2/\text{day}$

$S = 0.007299$

$S_y = 0.05222$

$\beta = 0.03$

**NAS NORTH ISLAND SITE 9
NoVOCs™ HYDROGEOLOGICAL INVESTIGATION**

**FIGURE 5-26
MW46 DRAWDOWN DATA PLOT
AND TYPE CURVE MATCH
(Upper Aquifer Zone Constant Rate Pumping Test)**



Tetra Tech EM Inc.

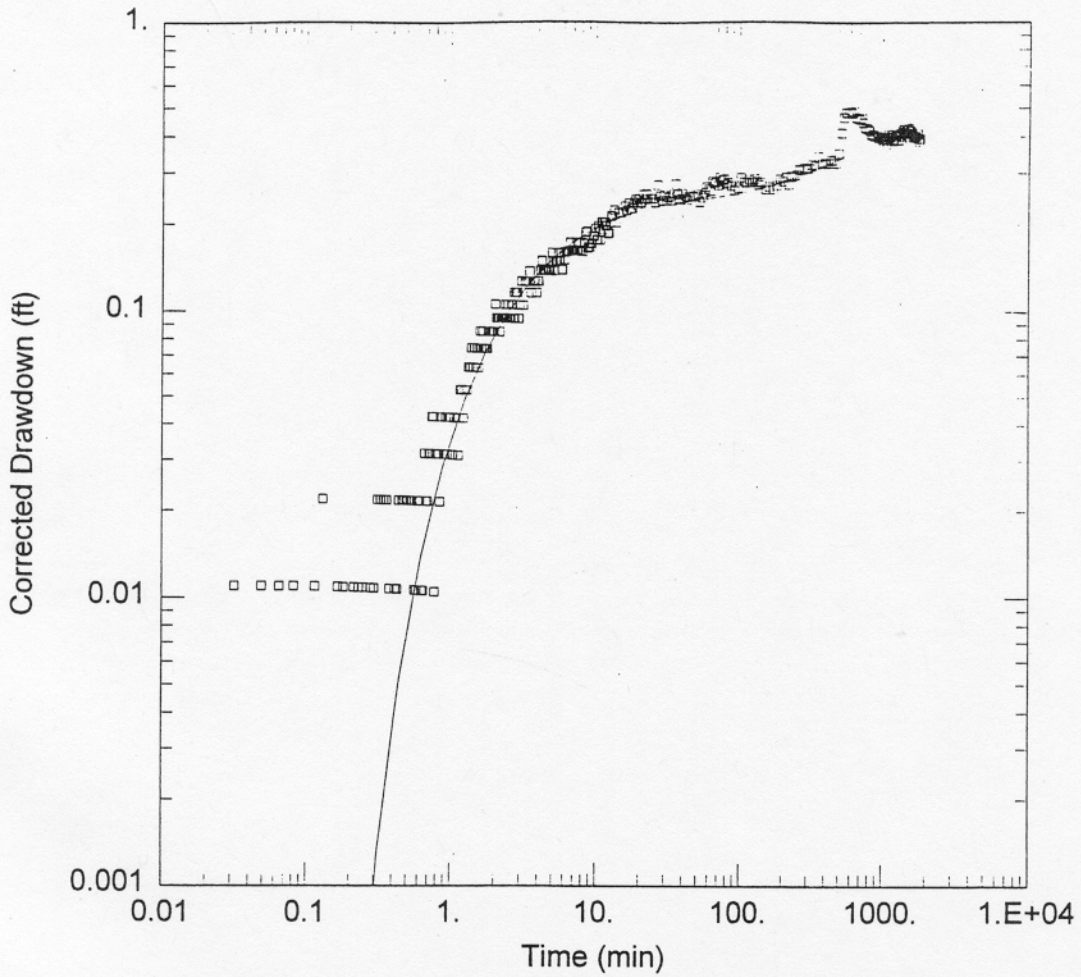

NAS NI SITE 9 PUMPING TEST DATA - MW-47

Data Set: S:\NOVOCSSWORKIN~2\CONSTA~2\MW47-88.AQT

Date: 02/12/99

Time: 17:25:47

SOLUTION

Aquifer Model: Unconfined

Solution Method: Neuman

$T = 2441.4 \text{ ft}^2/\text{day}$

$S = 0.001919$

$S_y = 0.05972$

$\beta = 0.03$

NAS NORTH ISLAND SITE 9
NoVOCs™ HYDROGEOLOGICAL INVESTIGATION

FIGURE 5-27
MW47 DRAWDOWN DATA PLOT
AND TYPE CURVE MATCH
(Upper Aquifer Zone Constant Rate Pumping Test)



Tetra Tech EM Inc.

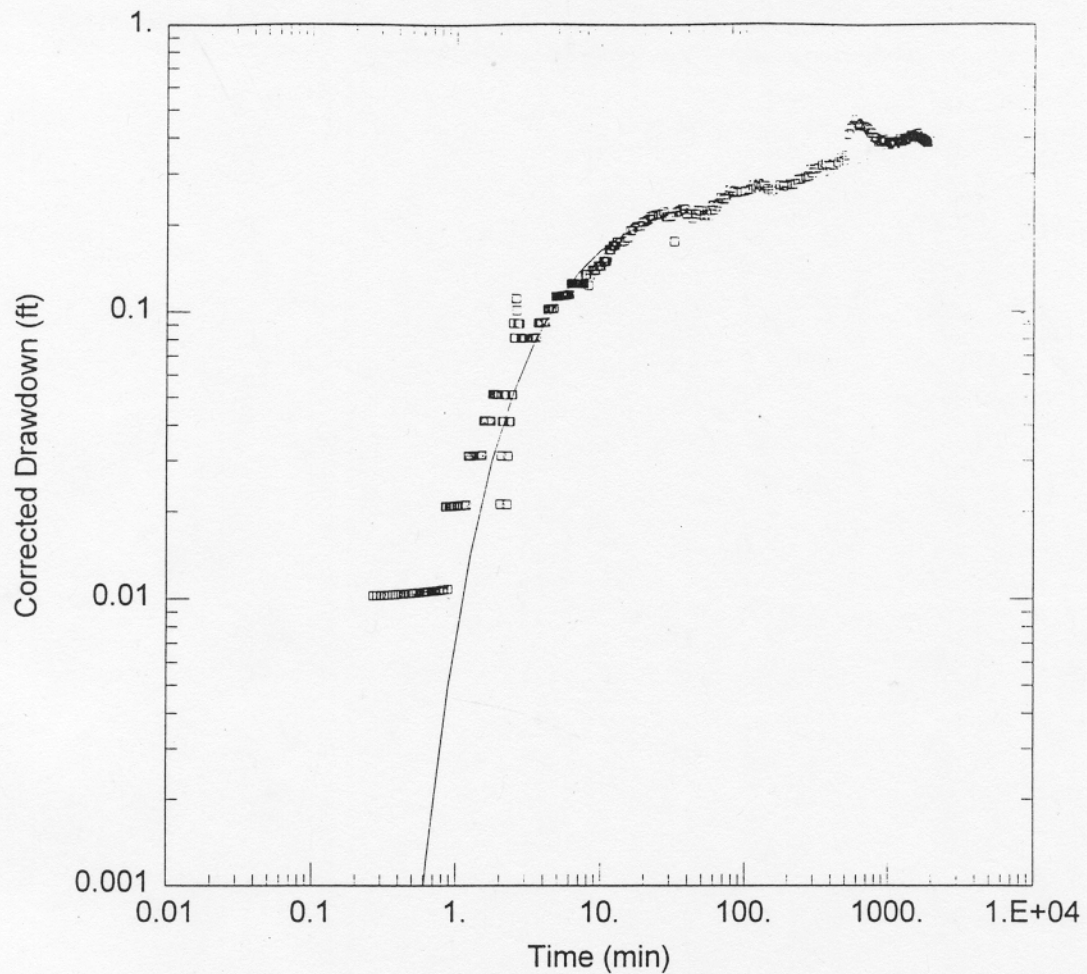

NAS NI SITE 9 PUMPING TEST DATA - MW48

Data Set: S:\NOVOCs\WORKIN~2\CONSTA~2\MW48-88.AQT

Date: 02/12/99

Time: 17:25:57

SOLUTION

Aquifer Model: Unconfined

Solution Method: Neuman

T = 2553. ft²/day

S = 0.004492

Sy = 0.08931

β = 0.09

NAS NORTH ISLAND SITE 9
NoVOCs™ HYDROGEOLOGICAL INVESTIGATION

FIGURE 5-28
MW48 DRAWDOWN DATA PLOT
AND TYPE CURVE MATCH
(Upper Aquifer Zone Constant Rate Pumping Test)



Tetra Tech EM Inc.

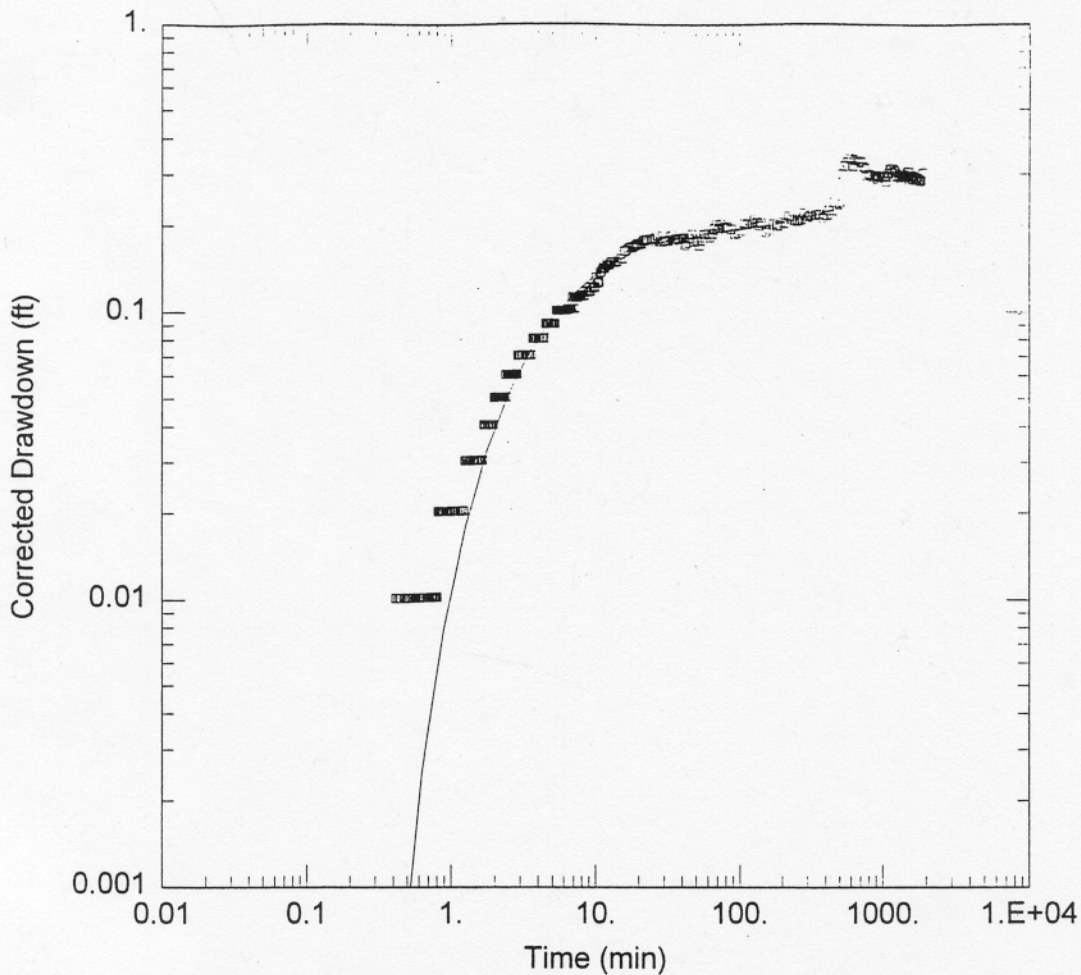

NAS NI SITE 9 PUMPING TEST DATA - MW49

Data Set: S:\NOVOCS\WORKIN~2\CONSTA~2\MW49-88.AQT

Date: 02/12/99

Time: 17:26:08

SOLUTION

Aquifer Model: Unconfined

Solution Method: Neuman

$T = 2774. \text{ ft}^2/\text{day}$

$S = 0.002236$

$S_y = 0.1075$

$\beta = 0.08$

NAS NORTH ISLAND SITE 9
NoVOCs™ HYDROGEOLOGICAL INVESTIGATION

FIGURE 5-29
MW49 DRAWDOWN DATA PLOT
AND TYPE CURVE MATCH
(Upper Aquifer Zone Constant Rate Pumping Test)



Tetra Tech EM Inc.

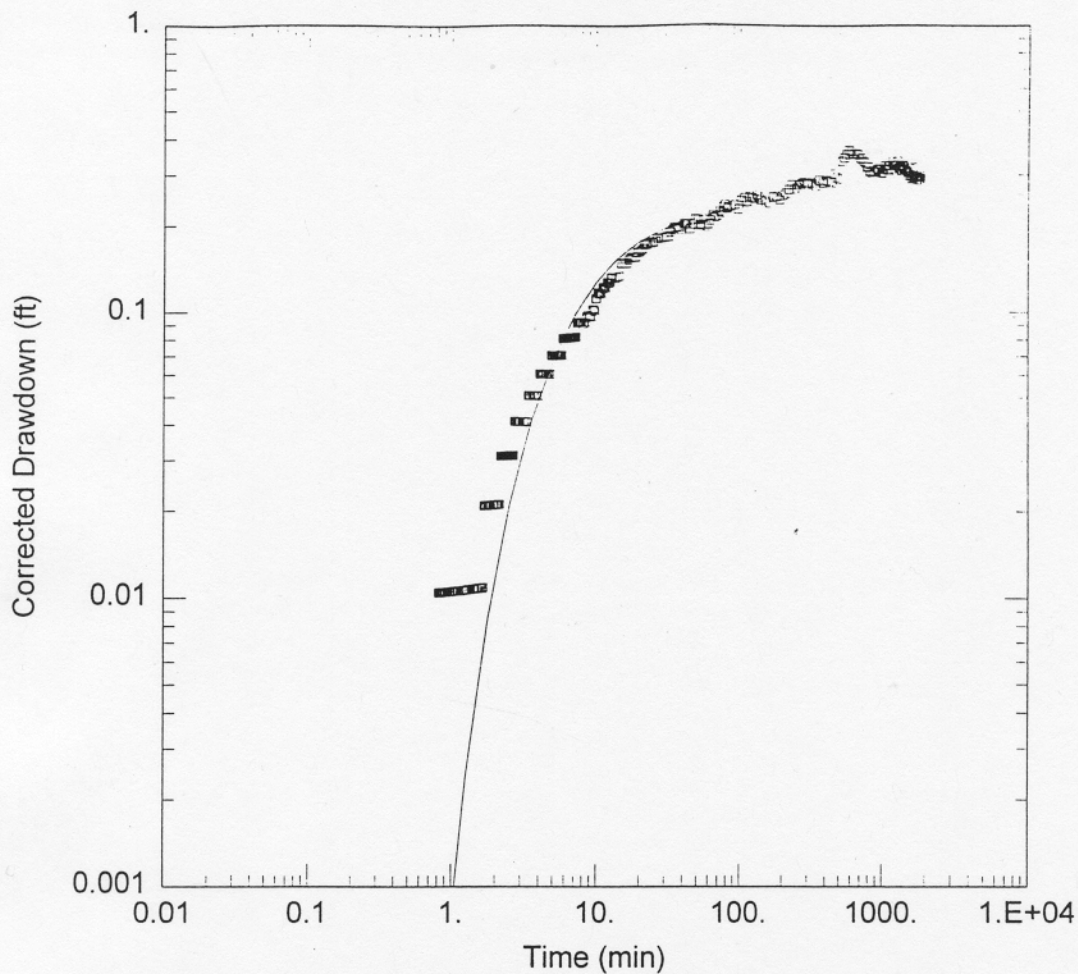

NAS NI SITE 9 PUMPING TEST DATA - MW52

Data Set: S:\NOVOCs\WORKIN~2\CONSTA~2\MW52-88.AQT

Date: 02/12/99

Time: 17:26:23

SOLUTION

Aquifer Model: Unconfined

Solution Method: Neuman

$T = 2550. \text{ ft}^2/\text{day}$

$S = 0.003845$

$S_y = 0.1$

$\beta = 0.09$

NAS NORTH ISLAND SITE 9
NoVOCs™ HYDROGEOLOGICAL INVESTIGATION

FIGURE 5-30
MW52 DRAWDOWN DATA PLOT
AND TYPE CURVE MATCH
(Upper Aquifer Zone Constant Rate Pumping Test)



Tetra Tech EM Inc.

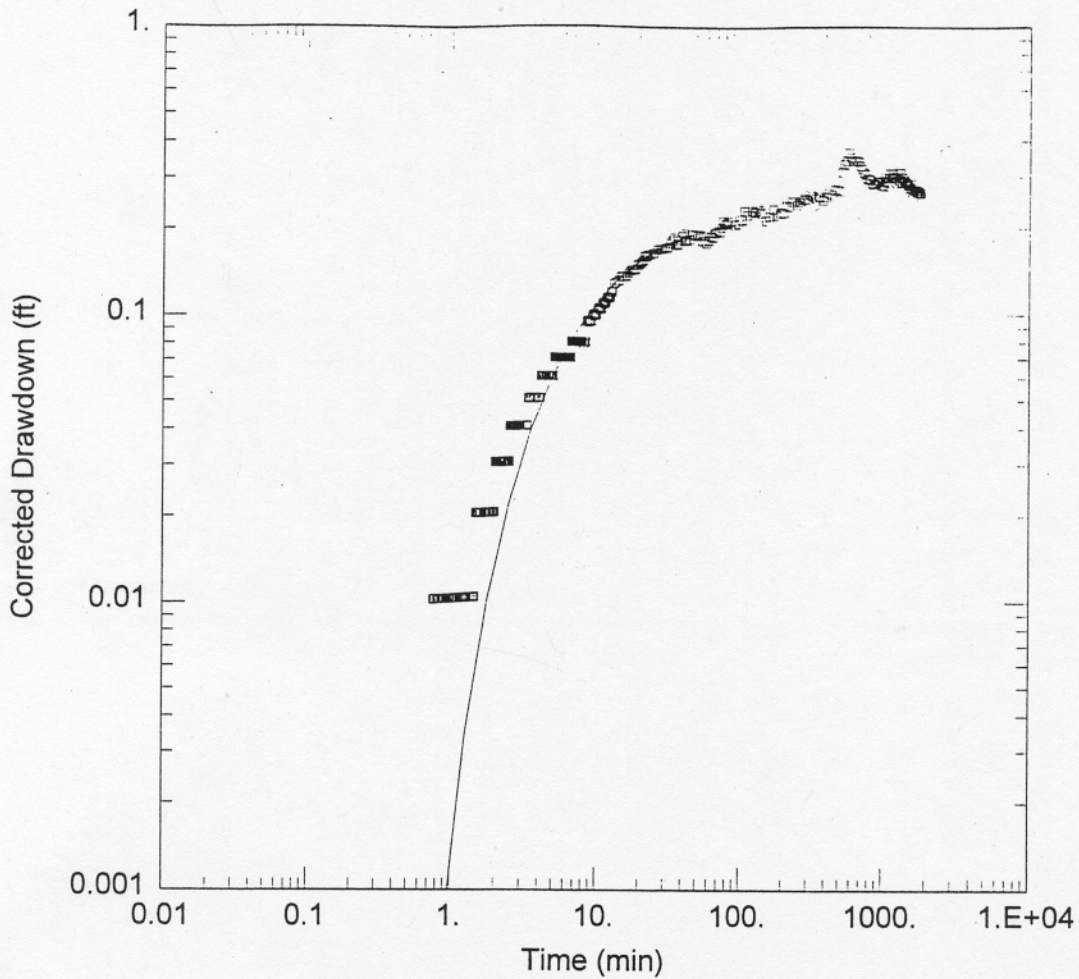

NAS NI SITE 9 PUMPING TEST DATA - MW53

Data Set: S:\NOVOCs\WORKIN~2\CONSTA~2\MW53-88.AQT

Date: 02/12/99

Time: 17:26:32

SOLUTION

Aquifer Model: Unconfined

Solution Method: Neuman

$T = 2198.7 \text{ ft}^2/\text{day}$

$S = 0.001353$

$S_y = 0.04903$

$\beta = 0.1$

NAS NORTH ISLAND SITE 9
NoVOCs™ HYDROGEOLOGICAL INVESTIGATION

FIGURE 5-31
MW53 DRAWDOWN DATA PLOT
AND TYPE CURVE MATCH
(Upper Aquifer Zone Constant Rate Pumping Test)



Tetra Tech EM Inc.

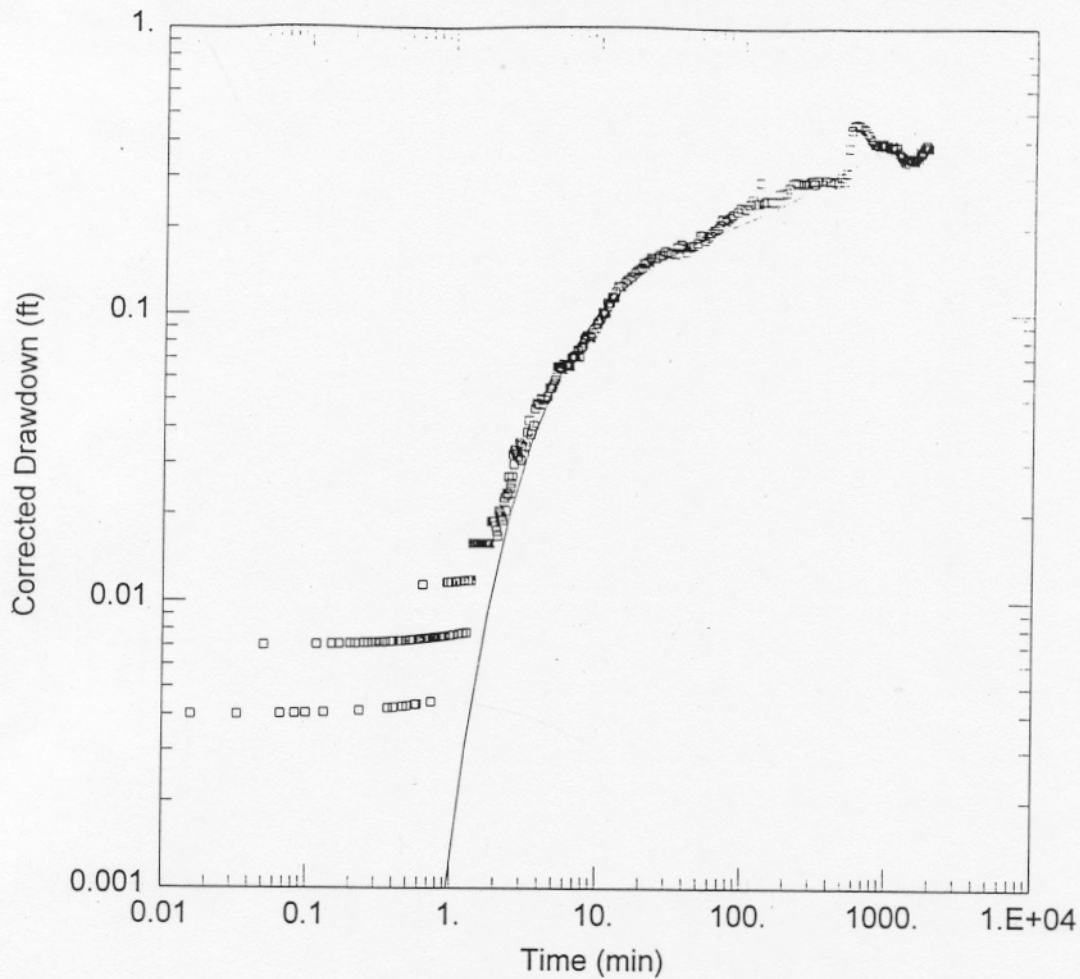

NAS NI SITE 9 PUMPING TEST DATA - MW54

Data Set: S:\NOVOC\WORKIN~2\CONSTA~2\MW54-88.AQT

Date: 02/12/99

Time: 17:26:44

SOLUTION

Aquifer Model: Unconfined

Solution Method: Neuman

$T = 2515. \text{ ft}^2/\text{day}$

$S = 0.002144$

$S_y = 0.015$

$\beta = 0.12$

NAS NORTH ISLAND SITE 9
NoVOCs™ HYDROGEOLOGICAL INVESTIGATION

FIGURE 5-32
MW54 DRAWDOWN DATA PLOT
AND TYPE CURVE MATCH
(Upper Aquifer Zone Constant Rate Pumping Test)



Tetra Tech EM Inc.



4th STREET WEST

EXISTING SVE PAD

NoVOCS-THERMATRIX EQUIPMENT PAD

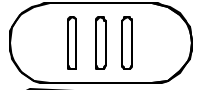

PROPANE TANKS

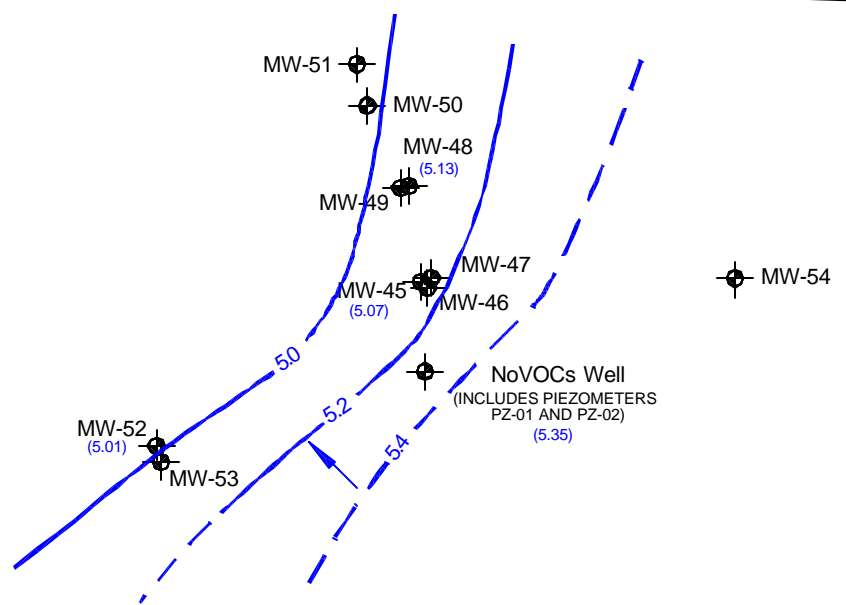

N 3rd STREET WEST



LEGEND

-  MW-52 (5.01) MONITORING WELL OR NoVOCS WELL (Equivalent Fresh Water Head Elevation in Feet)
-  5.0 THE MEAN EQUIVALENT FRESH WATER HEAD ELEVATION (MLLW) CONTOUR LINE WITH CONTOUR INTERVAL IN FEET
-  MEAN GROUND WATER FLOW DIRECTION

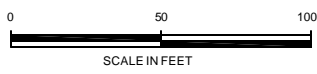

NAS NORTH ISLAND SITE 9
NoVOCS™ HYDROGEOLOGICAL INVESTIGATION

FIGURE 5-33

THE MEAN EQUIVALENT FRESH-WATER HEAD CONTOUR AND HORIZONTAL GROUNDWATER FLOW DIRECTION (Upper Aquifer Zone, Four Data Points, August 1998)

 Tetra Tech EM Inc.



4th STREET WEST

EXISTING SVE PAD

NoVOCS-THERMATRIX EQUIPMENT PAD

PROPANE TANKS

N 3rd STREET WEST

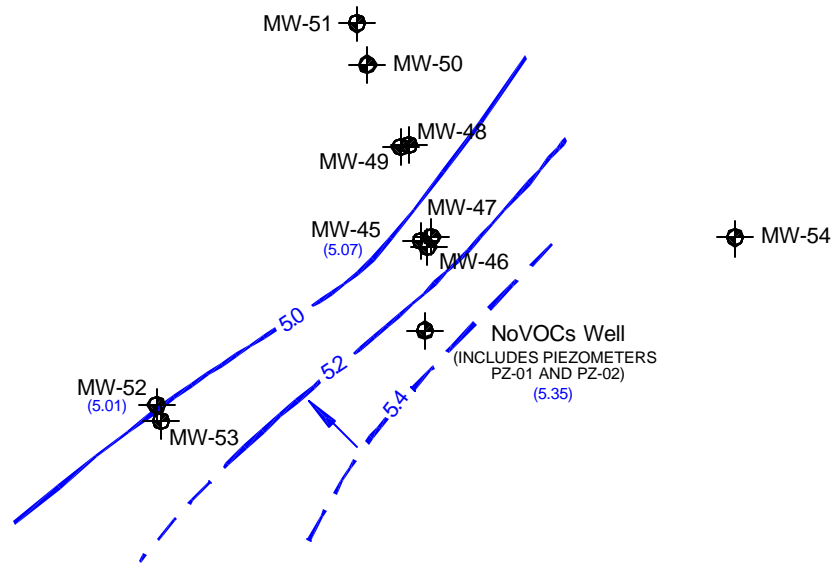

LEGEND

MW-52 (5.01) MONITORING WELL OR NoVOCS WELL (Equivalent Fresh Water Head Elevation in Feet)

5.0 THE MEAN EQUIVALENT FRESH WATER HEAD ELEVATION (MLLW) CONTOUR LINE WITH CONTOUR INTERVAL IN FEET

MEAN GROUND WATER FLOW DIRECTION

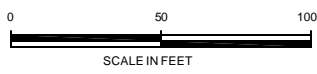

NAS NORTH ISLAND SITE 9
NoVOCS™ HYDROGEOLOGICAL INVESTIGATION



FIGURE 5-34

THE MEAN EQUIVALENT FRESH-WATER HEAD CONTOUR AND HORIZONTAL GROUNDWATER FLOW DIRECTION (Upper Aquifer Zone, Three Data Points, August 1998)

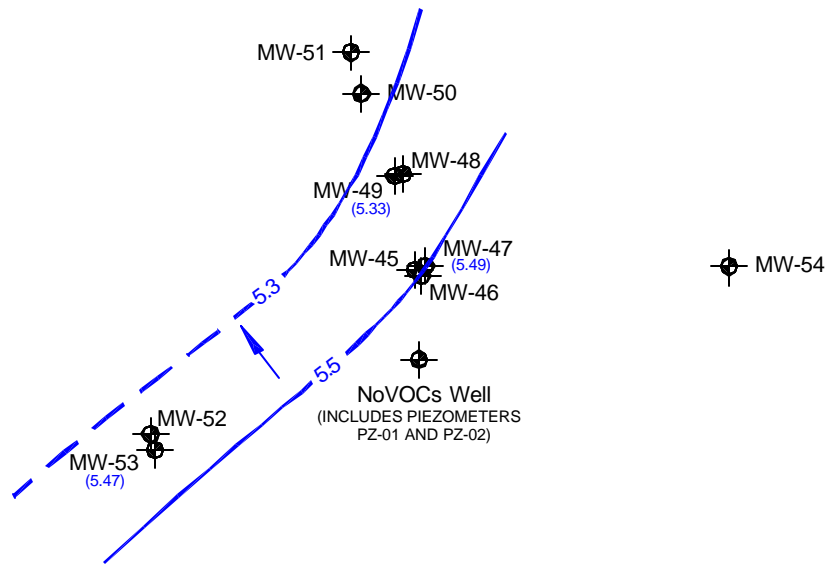
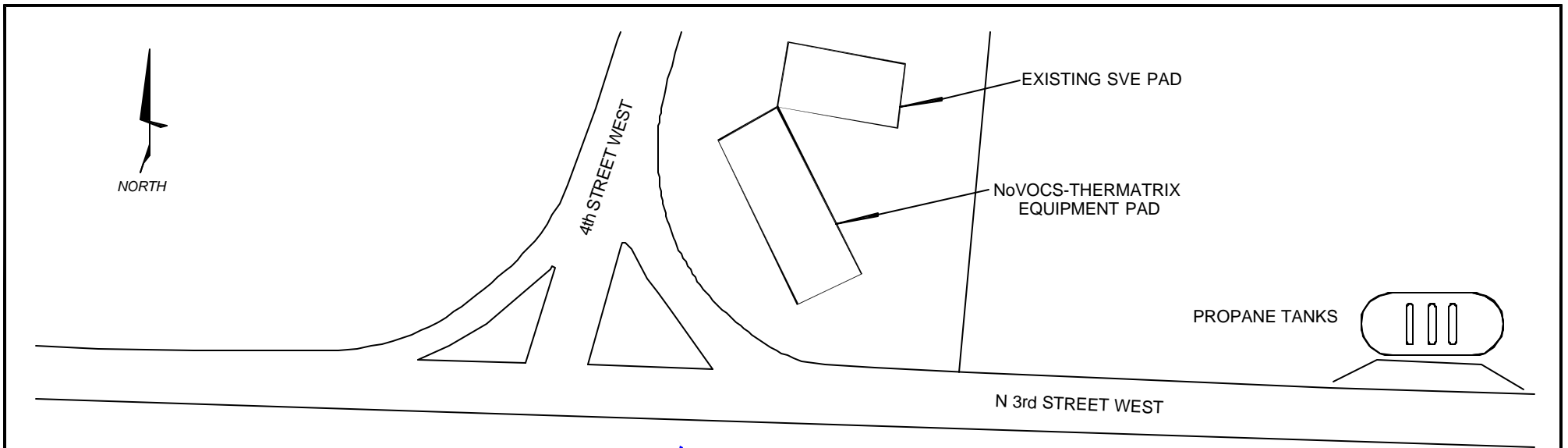
Tetra Tech EM Inc.



LEGEND

-  MW-53 (5.47) MONITORING WELL OR NoVOCS WELL (Equivalent Fresh Water Head Elevation in Feet)
-  5.3 THE MEAN EQUIVALENT FRESH-WATER HEAD ELEVATION (MLLW) CONTOUR LINE WITH CONTOUR INTERVAL IN FEET
-  MEAN GROUND WATER FLOW DIRECTION



NAS NORTH ISLAND SITE 9
NoVOCS™ HYDROGEOLOGICAL INVESTIGATION

FIGURE 5-35

THE MEAN EQUIVALENT FRESH-WATER HEAD CONTOUR AND HORIZONTAL GROUNDWATER FLOW DIRECTION (Lower Aquifer Zone, Three Data Points, August 1998)

 Tetra Tech EM Inc.

TABLE 5-1

**TIDAL INFLUENCE PARAMETER VALUES
TIDAL INFLUENCE STUDY OF APRIL 10 THROUGH 20, 1998
NoVOCs™ HYDROGEOLOGICAL INVESTIGATION
NAS NORTH ISLAND**

Measurement Point	Range (feet)			Tidal Efficiency			Time Lag (minutes)		
	Minimum	Maximum	Mean	Minimum	Maximum	Mean	Minimum	Maximum	Mean
San Diego Bay	1.72	8.11	5.27	1.00	1.00	1.00	0	0	0
MW45	0.11	0.58	0.36	0.05	0.08	0.07	52	94	70
MW46	0.09	0.56	0.36	0.05	0.08	0.07	52	94	71
MW47	0.09	0.58	0.36	0.05	0.08	0.07	46	94	72
MW48	0.10	0.58	0.36	0.05	0.08	0.07	52	90	72
MW49	0.11	0.58	0.37	0.05	0.08	0.07	56	93	71
MW50	0.10	0.60	0.37	0.05	0.08	0.07	52	96	72
MW52	0.12	0.72	0.46	0.07	0.10	0.09	46	85	69
MW53	0.12	0.73	0.45	0.06	0.10	0.09	54	93	70

Note:

Values presented are based on calculations for each of the 39 tidal periods during the 10-day study. A tidal period extends from consecutive high to low or low to high tidally influenced groundwater levels.

TABLE 5-2

**PARAMETERS USED IN TIDAL CORRECTION
FOR THE CONSTANT DISCHARGE PUMPING TEST
NoVOCs™ HYDROGEOLOGICAL INVESTIGATION
NAS NORTH ISLAND**

Well ID	Tidal Efficiency			Time Lag (minutes)		
	Minimum	Maximum	Mean	Minimum	Maximum	Mean
MW45	0.05	0.10	0.09	52	94	73
MW46	0.05	0.10	0.09	52	94	72
MW47	0.05	0.10	0.09	50	94	72
MW48	0.05	0.10	0.08	52	93	71
MW49	0.05	0.10	0.08	52	93	70
MW52	0.07	0.11	0.10	50	90	70
MW53	0.06	0.11	0.10	50	90	70
MW54	0.05	0.09	0.07	52	94	72

TABLE 5-3

**AQUIFER TEST DATA AND THE NoVOCs™WELL SPECIFIC CAPACITY
NoVOCs™HYDROGEOLOGICAL INVESTIGATION
NAS NORTH ISLAND**

Type of Test	Test Step	Pumping or Recharge Rate (Q) (gpm)	Measured Maximum Drawdown or Water Level Rise(s) (feet)	Specific Capacity^a (gpm/foot)	Average Specific Capacity (gpm/ft)
Upper Aquifer zone Step Drawdown Test	1	10	5.89	1.70	1.48
	2	15	11.08	1.35	
	3	20	14.31	1.40	
Upper Aquifer zone Injection Test	1	5	3.45	1.45	1.50
	2	15	9.54	1.57	
	3	22	14.82	1.48	
	4	25	16.56	1.51	
Deep Aquifer zone Step Drawdown Rest	1	40	11.40	3.51	3.22
	2	50	15.35	3.26	
	3	64	20.86	3.07	
	4	30	9.92	3.02	

Notes:

- a Specific capacity was calculated by dividing pumping or recharge rate (Q) by maximum drawdown or water level rise (s).
- gpm gallons per minute

TABLE 5-4

**AQUIFER TEST DATA AND WELL EFFICIENCY
NoVOCs™HYDROGEOLOGICAL INVESTIGATION
NAS NORTH ISLAND**

Type of Test	Pumping or Recharge Rate (Q) (gpm)	Measured Maximum Drawdown or Water Level Rise (s) (feet)	Well Loss Coefficient ^a (C)	Well Loss ^a (CQ ²) (feet)	Well Efficiency ^b (%)	Average Well Efficiency (%)
Upper Aquifer zone Step Drawdown Test	10	5.89	0.0084 ^c	0.84	85	82
	15	11.08		1.89	83	
	20	14.31		3.36	77	
Upper Aquifer zone Injection Test	5	3.45	0.0012 ^d	0.03	99	97
	15	9.54		0.27	97	
	22	14.82		0.58	96	
	25	16.56		0.75	95	
Deep Aquifer zone Step Drawdown Test	30	9.92	0.0006 ^e	0.54	95	91
	40	11.57		0.96	92	
	50	15.35		1.50	90	
	64	20.86		2.46	88	

Notes:

a Defined by Equation 5-18

b Calculated using Equation 5-19, where well efficiency in percent (E_{well}) is defined as follows: $E_{well} = \frac{s - CQ^2}{s} \times 100$

c From best fit equation for data in Figure 5-11

d From best fit equation for data in Figure 5-12

e From best fit equation for data in Figure 5-13

gpm gallons per minute

TABLE 5-5

**UPPER AQUIFER ZONE
CONSTANT DISCHARGE PUMPING TEST CONFIGURATION
NoVOCs™HYDROGEOLOGICAL INVESTIGATION
NAS NORTH ISLAND**

GENERAL INFORMATION			
Pumping well:	NoVOCs™well (upper screen interval)		
Pumping well casing diameter:	8 inches		
Pumping rate:	20 gallons per minute		
Pumping duration:	32 hours		
Initial groundwater level:	17 feet bgs		
Aquifer saturation thickness:	88 feet		
PUMPING AND OBSERVATION WELL INFORMATION			
Well ID ^a	Distance from the Pumping Well (feet)	Screen Interval	
		Depth (feet bgs)	Elevation (feet relative to MLLW)
IW-01 (NoVOCs™well)	0	43 to 47 and 72 to 78	-21.3 to -25.3 and -50.3 to -56.3
MW-45	29.8	42 to 47	-20.0 to -25.0
MW-46	27.7	57 to 62	-35.4 to -40.4
MW-47	31.1	72 to 78	-49.9 to -55.9
MW-48	61.9	52 to 57	-28.6 to -33.6
MW-49	61.7	67 to 72	-43.6 to -48.6
MW-52	93.0	41 to 46	-19.1 to -24.1
MW-53	93.1	72 to 77	-50.4 to -55.4
MW-54	107.9	38 to 78	-18.0 to -58.0

Notes:

- a Observation wells MW-50 and MW-51 are not included because no data are available due to datalogger malfunction
- bgs Below ground surface
- MLLW Mean lower low water level

TABLE 5-6

**CONSTANT DISCHARGE PUMPING TEST INFORMATION
NoVOCs™HYDROGEOLOGICAL INVESTIGATION
NAS NORTH ISLAND**

Well ID	Well Function	Distance from Pumping Well (feet)	Initial Response Time (minute)	Maximum Drawdown at the End of the Test ^a (feet)	Screen Interval	
					Depth (feet bgs)	Elevation (feet relative to MLLW)
NoVOCs™Well (upper screen)	Pumping	0	0	16.02	43 to 47	-21.3 to -25.3
MW-45	Observation	29.8	0.51	0.63	42 to 47	-20.0 to -25.0
MW-46	Observation	27.7	0.53	0.46	57 to 62	-35.4 to -40.4
MW-47	Observation	31.1	0.66	0.40	72 to 78	-49.9 to -55.9
MW-48	Observation	61.9	0.75	0.23	52 to 57	-28.6 to -33.6
MW-49	Observation	61.7	0.75	0.18	67 to 72	-43.6 to -48.6
MW-52	Observation	93.0	0.80	0.22	41 to 46	-19.1 to -24.1
MW-53	Observation	93.1	0.90	0.20	72 to 77	-50.4 to -55.4
MW-54	Observation	107.9	1.30	0.26	38 to 78	-18.0 to -58.0

Notes:

- a Observation well drawdown data have been tidally corrected
- bgs Below ground surface
- MLLW Mean lower low water level

TABLE 5-7

**AQUIFER HYDRAULIC PARAMETERS
UPPER AQUIFER CONSTANT DISCHARGE PUMPING TEST
NOVOCS™ HYDROGEOLOGICAL INVESTIGATION
NAS NORTH ISLAND**

Observation Well	Transmissivity (T) (feet ² /day)	Hydraulic Conductivity (K)		Storativity (S) (dimensionless)	Specific Yield (S _y) (dimensionless)	Neuman Delayed Yield factor (b) (dimensionless)	Ratio of Vertical to Horizontal K (K _z /K _r) (dimensionless)
		(feet/day)	(cm/sec)				
MW-45	2,450	28	0.010	0.0084	0.12	0.03	0.26
MW-46	2,722	31	0.011	0.0073	0.05	0.03	0.30
MW-47	2,441	28	0.010	0.0019	0.06	0.03	0.24
MW-48	2,553	29	0.010	0.0045	0.09	0.09	0.18
MW-49	2,774	32	0.011	0.0022	0.11	0.08	0.16
MW-52	2,550	29	0.010	0.0038	0.10	0.09	0.08
MW-53	2,199	25	0.009	0.0014	0.05	0.10	0.09
MW-54	2,515	29	0.010	0.0021	0.02	0.12	0.08
Average	2,526	29	0.010	0.0040	0.07	0.07	0.17
DFT	2,771	33	0.0115	0.001~0.01	N/A	N/A	0.20

TABLE 5-8

**MEAN GROUNDWATER AND EQUIVALENT FRESH-WATER HEADS
NoVOCs™HYDROGEOLOGICAL INVESTIGATION
NAS NORTH ISLAND**

Aquifer Zone	Well ID	Mean Groundwater Elevation after Tidal Correction (feet MLLW)	Parameters Used in Calculating Equivalent Fresh- Water Heads				Equivalent Fresh - Water Heads ^c (feet MLLW)
			TDS Concentration (mg/L)	Groundwater Density ^a (kg/m ³)	Groundwater Specific Gravity (unitless)	Well Screen Elevation ^b (feet MLLW)	
Upper Zone	MW45	4.78	17,600	1,011	1.011	-22.51	5.07
	MW48	4.56	25,700	1,016	1.016	-31.08	5.13
	MW52	4.64	22,700	1,014	1.014	-21.55	5.01
	PW	4.97	21,300	1,013	1.013	-23.77	5.35
Lower Zone	MW47	4.33	32,000	1,020	1.020	-52.35	5.49
	MW49	4.40	29,200	1,019	1.019	-46.08	5.33
	MW53	4.34	31,000	1,020	1.020	-52.91	5.47

Notes:

- A Density is calculated based on Equation 5-31
- B Well screen elevation is determined as the middle point of the well screen
- C Equivalent fresh- water head is calculated based on Equation 5-30

6.0 CONCLUSIONS

The hydrogeological investigation of the aquifer treated by the NoVOCs™ system has yielded valuable information regarding the hydraulic characteristics of the aquifer, pumping and injection capacities of the NoVOCs™ well, and defects in the NoVOCs™ well. The conclusions of the investigation are as follows:

- The tested aquifer is significantly influenced by tidal fluctuations in San Diego Bay, as demonstrated by the drawdown data collected from the observation wells during the constant discharge pumping test of the NoVOCs™ well.
- The tidal effects on groundwater levels must be corrected to allow the calculation of aquifer parameters and the mean groundwater elevations.
- Groundwater levels must be corrected for density effect for determination of groundwater flow patterns. The mean equivalent fresh water head contour maps show that groundwater at the vicinity of the NoVOCs™ well flows to the west or northwest in both of the upper and lower aquifer zones. The horizontal hydraulic gradient of the two aquifer zones ranges from 0.005 to 0.01.
- Two methods were developed for tidal correction of groundwater drawdown data obtained during the constant discharge pumping test. The methods involve using the tidal influence study data collected in April 1998 to calculate the tidal efficiency and time lag for each of the observation wells. The estimated tidal efficiency ranges from 0.05 to 0.1 in different tidal cycles at different wells; the estimated time lags range from 46 to 96 minutes.
- Observed drawdown data collected during the constant discharge pumping test were corrected using the two new tidal correction methods. The corrected drawdown (that is, drawdown data with the tidal effects removed) using both methods correlates well with each other and reflects typical pumping test responses. The corrected drawdown matches reasonably well with Neuman type curves for the aquifer parameter estimation.
- The aquifer hydraulic parameters were estimated based on the tidally corrected groundwater drawdown data for the constant discharge pumping test. The average hydraulic conductivity was estimated as 29ft/day or 0.01 cm/sec. The average aquifer storativity and specific yield are 0.004 and 0.07. The average ratio of horizontal to vertical hydraulic conductivity is estimated at 5.7.
- Specific capacity and efficiency of the NoVOCs™ well were estimated based on the step-drawdown tests and water injection test conducted at the NoVOCs™ well. The calculated average specific capacities are 1.48 gpm/ft for the upper screened pumping, 1.50 gpm/ft for the upper screened injection, and 3.22 gpm/ft for the lower screened pumping. The calculated average well efficiencies are 82 percent for the upper screened pumping, 97 percent for the upper screened injection, and 91 percent for the lower screened pumping. The 97-percent well efficiency for the upper screened injection is for injection of clean tap water.

- The radius of influence during the constant discharge pumping test (20 gpm) was at least 100 feet based on drawdown measured at the observation wells. No data were collected from the observation well farthest from the pumping well (MW-54), which is 105 feet from the NoVOCs™ well.
- No positive (recharge) or negative (flow barrier) boundaries are evident from the constant discharge pumping test data.
- The injection test results show that the maximum flow of clean tap water that can be injected through the upper screen of the NoVOCs™ well is 25 gpm. At that injection rate, the water level will rise 17 feet and reach the ground surface.
- The video survey of the NoVOCs™ well revealed a manufacturing defect in the upper well screen. The screen slots are unevenly cut, and about 30 percent of the slots do not completely penetrate the PVC casing. This defect affects the well efficiency of the upper screened interval and may reduce the available water level rise in the NoVOCs™ well during recharge to the aquifer through the upper screen.
- The video survey also revealed significant fouling of the NoVOCs™ well screens by iron precipitation and microbiological growth. Such fouling may impair the performance of the NoVOCs™ system by obstructing the well screen and filter pack.
- The findings of the aquifer tests and tidal study of the aquifer treated by the NoVOCs™ system indicate that the aquifer hydraulic conditions are suitable for application of the NoVOCs™ technology. The NoVOCs™ well as designed should be able to extract and inject a flow rate of 20 gpm based on the aquifer hydraulic characteristics.

7.0 REFERENCES

- Bechtel National, Inc. (Bechtel). 1996. Final Technical Memorandum, Additional Site Characterization for NoVOCs™Technology Demonstration at Site 9, Naval Air Station (NAS) North Island, San Diego, California. CTO-0084/0065. March.
- Bechtel. 1997a. Final Technical Memorandum, S9-CPT-05 Site Characterization for NoVOCs™Technology at Site 9, NAS North Island, San Diego, California. CTO-0084/0160. June.
- Bechtel. 1997b. Draft Addendum to Action Memorandum/Remedial Action Plan for Removal Action at Installation Restoration Site 9, Naval Air Station North Island, Coronado, California. CTO-084/0159. June.
- Bechtel. 1998. Final Boring Logs, Cone Penetrometer Test Data, and Geologic Cross-Section of Site 9. Naval Air Station North Island.
- Bierschenk, W.H. 1964. "Determining Well Efficiency by Multiple Step-Drawdown Tests." Publication 64, International Association of Scientific Hydrology.
- de Marsily, G. 1986. *Quantitative Hydrogeology*. Academic Press, Inc. Page 440.
- Dawson, K.J. and J.D. Istok 1991. *Aquifer Testting, Design and Analysis of Pumping and Slug Tests*. Lewis publishers. Chelsea, Michigan.
- Driscoll, Fletcher, G. 1986. *Groundwater and Wells*. Second Edition.
- Duffield, G.M. and J.O. Rumbaugh, III. 1991. "AQTESOLV—Aquifer Test Solver." Geraghty & Miller Modeling Group. Reston, Virginia.
- EG&G Environmental (EG&GE). 1996. Final Work Plan for NoVOCs™Pilot Test at NAS North Island. June.
- EG&GE. 1997. Well Design for NAS North Island. August 13.
- Erskine, A.D. 1991. "The Effect of Tidal Fluctuation on a Coastal Aquifer in the UK." *Groundwater*. Vol. 29, No. 4. Pages 556-562.
- Ferris, J.G. 1951. "Cyclic Fluctuations of Water Level as a Basis for Determining Aquifer Transmissivity." *International Association of Scientific Hydrology. Publication 33*. Pages 148-155.
- Freeze, R.A., and J.A. Cherry. 1979. *Groundwater*. Prentice-Hall, Inc. Englewood Cliffs, NJ.
- Jacob, C.E. 1947. "Drawdown Test to Determine Effective Radius of Artesian Well". ASCE Transactions. Vol. 112, Paper 2321. Pages 1047-1070.
- Jacob, C.E. 1950. *Flow of Ground Water. Engineering Hydraulics*. Edited by H. Rouse. John Wiley and Sons, Inc., New York. Pages 321-386.

- Jacobs Engineering Group, Inc. (Jacobs). 1994. Technical Memorandum, Site 9 - Chemical Waste Disposal Area, NAS North Island, Volume I, Revision 0. April 6.
- Jacobs. 1995a. Draft Remedial Investigation/Resource Conservation and Recovery Act Facility Investigation Report, Site 9 - Chemical Waste Disposal Area, NAS North Island, Volume I, Revision 0. October.
- Jacobs. 1995b. Naval Air Station North Island, San Diego, California, Remedial Investigation, RCRA Facility Investigation Report, Site 9, Chemical Waste Disposal Area. October.
- HydroSOLVE, Inc. 1996. AQTESOLV for Windows, User's Guide.
- Lennox, D.H. 1966. "Analysis and Application of Step-Drawdown Test. *Journal of the Hydraulics*. ASCE DIV. HY 6. November, Pages 25-48.
- Kabala, Z.J. 1993. "The Dipole Flow Test: A New Single Borehole Test for Aquifer Characterization." *Water Resources Research*. Vol. 29, No. 1. Page 99-107. January.
- Kawecki, M.W. "Meaningful Interpretation of Step-Drawdown Tests." *Ground Water*. Vol. 33, No. 1. Pages 23-32.
- Kennedy. 1975. Geology of the San Diego Metropolitan Area, California. California Division of Mines and Geology. Bulletin 200.
- Neuman, S.P. 1974. "Effect of partial penetration on flow in unconfined aquifers considering delayed gravity response." *Water Resources Research*. Vol. 10, No. 2. Pages 303-312.
- Neuman, S.P. 1975. "Analysis of Pumping Test Data from Anisotropic Unconfined Aquifers Considering Delayed Gravity Response." *Water Resources Research*. Vol. 11, No. 2. Pages 329-342.
- Rorabaugh, M.I. 1953. "Graphical and Theoretical Analysis of Step-Drawdown Test of Artesian Well." ASCE Proceedings Separate No. 362. Vol.79. Pages 1-23.
- Serfes, M.E. 1991. "Determining the Mean Hydraulic Gradient of Ground Water Affected by Tidal Fluctuations." *Groundwater*. Vol. 29, No. 4. Pages 549-555.
- SPARWAR Systems Center (SPARWAR). 1998. Draft Report of Findings: Offshore Sampling of Porewater VOC Levels and Groundwater VOC Fluxes to San Diego Bay at Site 9, Naval Air Station North Island. SPARWAR Systems Center, San Diego, California.
- Tetra Tech EM Inc. 1998. Technology Evaluation Plan/Quality Assurance Project Plan for the MACTEC Environmental NoVOCs™ Technology Evaluation at the Naval Air Station, North Island, California. May.
- Theis, C.V. 1935. "The relation between the lowering of the piezometric surface and the rate and duration of discharge of a well using groundwater storage." *American Geophysical Union Trans.* Volume 16. Pages 519-524.

NoVOCs™ Technology Evaluation Report

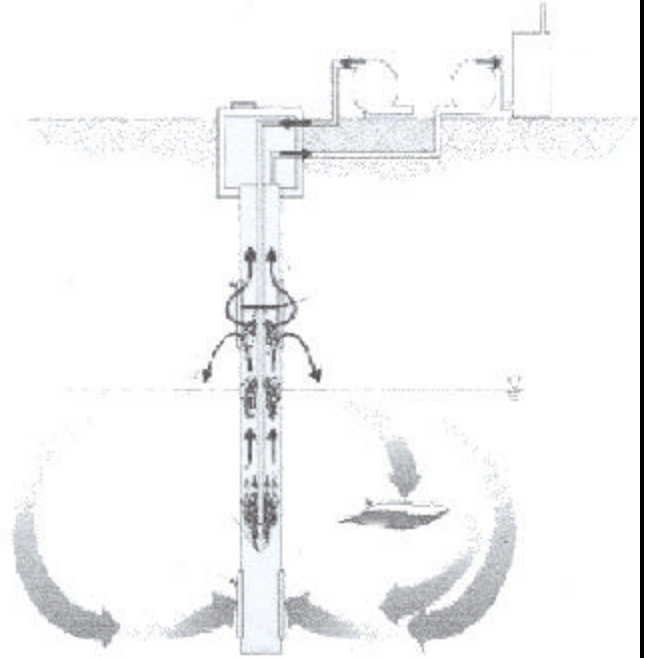

Appendix C Hydrogeological Report



**HYDROGEOLOGICAL INVESTIGATION OF THE
AQUIFER TREATED BY THE NoVOCs™ SYSTEM**

**NAVAL AIR STATION NORTH ISLAND
SAN DIEGO, CALIFORNIA**

Prepared For

**U.S. Environmental Protection Agency
National Risk Management Research Laboratory
Superfund Innovative Technology Evaluation Program
Cincinnati, Ohio**

Prepared by

**Tetra Tech EM Inc.
San Diego, California**

August 3, 2000

TABLE OF CONTENTS

<u>Section</u>	<u>Page</u>
EXECUTIVE SUMMARY	ES-1
1.0 INTRODUCTION	1-1
1.1 SITE PROGRAM.....	1-2
1.2 PROJECT OBJECTIVES	1-2
2.0 BACKGROUND.....	2-1
2.1 THE NoVOCs™SYSTEM.....	2-1
2.1.1 General Description.....	2-1
2.1.2 NoVOCs™Monitoring System at NAS North Island.....	2-2
2.2 SITE HISTORY	2-2
2.3 SITE TOPOGRAPHY	2-4
2.4 REGIONAL AND SITE GEOLOGY	2-4
2.4.1 Regional Geology	2-4
2.4.2 Site Geology	2-4
2.5 SITE HYDROGEOLOGY.....	2-5
2.6 SOIL AND GROUNDWATER CONTAMINATION.....	2-6
3.0 TIDAL INFLUENCE STUDY.....	3-1
3.1 CONFIGURATION AND PROCEDURES.....	3-1
3.2 RESULTS	3-2
3.2.1 Tidal Influence	3-2
3.2.2 NoVOCs™System Influence.....	3-3
4.0 AQUIFER TESTING.....	4-1
4.1 PRETESTING ACTIVITIES	4-1
4.1.1 NoVOCs™Equipment Removal.....	4-2
4.1.2 Video Survey and Well Screen Development.....	4-2
4.1.3 Aquifer Test Equipment Installation and Configuration	4-3
4.1.4 Data Logger Programming	4-5
4.2 STEP DRAWDOWN TEST OF THE UPPER SCREENED INTERVAL	4-6
4.2.1 Procedures	4-6
4.2.2 Results.....	4-6
4.3 CONSTANT DISCHARGE PUMPING TEST OF THE UPPER SCREENED INTERVAL.....	4-7
4.3.1 Procedures	4-7
4.3.2 Results.....	4-8

TABLE OF CONTENTS (continued)

4.4	INJECTION TEST OF THE UPPER SCREENED INTERVAL.....	4-8
4.4.1	Procedures	4-8
4.4.2	Results.....	4-9
4.5	STEP DRAWDOWN TEST OF THE LOWER SCREENED INTERVAL.....	4-9
4.5.1	Procedures	4-10
4.5.2	Results.....	4-10
4.6	DIPOLE FLOW TEST	4-10
4.6.1	Configuration and Procedures.....	4-11
4.6.2	Results.....	4-11
4.7	WATER QUALITY PARAMETERS.....	4-12
5.0	DATA INTERPRETATION.....	5-1
5.1	TIDAL INFLUENCE CORRECTION.....	5-1
5.1.1	Relationship Between Tide and Groundwater Fluctuation.....	5-1
5.1.2	Procedure for Calculating Tidal Efficiency and Time Lag	5-3
5.1.3	Calculation of Tidal Efficiency and Time Lag Using April 1998 Tidal Study Data.....	5-5
5.1.4	Procedures for Tidal Correction of Groundwater Drawdown Data.....	5-6
5.1.5	Tidal Influence Correction for the Constant Pumping Test.....	5-13
5.2	CALCULATION OF SPECIFIC CAPACITY AND WELL EFFICIENCY.....	5-14
5.2.1	Specific Capacity Calculation.....	5-14
5.2.2	Well Loss and Well Efficiency	5-15
5.3	AQUIFER HYDRAULIC PARAMETER CALCULATION.....	5-19
5.3.1	Site Hydrogeologic Conceptual Model.....	5-20
5.3.2	Constant Discharge Pumping Test Configuration	5-21
5.3.3	Drawdown Response Characteristics.....	5-21
5.3.4	Selection of Analytical Model	5-23
5.3.5	Results and Discussion.....	5-24
5.4	DETERMINATION OF GROUNDWATER FLOW PATTERNS.....	5-25
5.4.1	Mean Groundwater Level Calculation from Tidally Influence Water Levels	5-26
5.4.2	Density Correction of Groundwater Levels.....	5-27
5.4.3	Corrected Water Levels and Horizontal Groundwater Flow Direction	5-31
5.4.4	Vertical Hydraulic Gradient Correction	5-33
5.5	DIPOLE FLOW TEST	5-37
5.5.1	Mathematical Models.....	5-37
5.5.2	Modified Dipole Flow Test Solution for Wellbore Storage	5-39
5.5.3	Dipole Flow Test Data Interpretation and Aquifer Anisotropy Estimation	5-41
6.0	CONCLUSIONS.....	6-1
7.0	REFERENCES.....	7-1

APPENDICES

Appendix

- A LOG OF BORING S9-SB-34(BECHTEL 1998)
- B HYDROGRAPHS (TIDAL STUDY)
- C HYDROGRAPHS (STEP DRAWDOWN TEST UPPER SCREEN INTERVAL)
- D HYDROGRAPHS (CONSTANT DISCHARGE PUMPING TEST)
UPPER SCREEN INTERVAL)
- E HYDROGRAPHS (INJECTION TEST UPPER SCREEN INTERVAL)
- F HYDROGRAPHS (STEP DRAWDOWN TEST LOWER SCREEN INTERVAL)
- G GRAPHS (DIPOLE TEST)
- H DATA LOGGER AND PRESSURE TRANSDUCER SPECIFICATIONS

FIGURES

(All figures follow the text of each section.)

Figure

- 1-1 VICINITY MAP
- 1-2 NAS NORTH ISLAND AND SITE 9 LOCATION MAP
- 1-3 SITE 9 CHEMICAL WASTE DISPOSAL AREA
- 2-1 NoVOCs™SYSTEM
- 2-2 WELL LOCATIONS
- 2-3 GENERALIZED CROSS-SECTION
- 2-4 SITE 9 TOPOGRAPHIC ELEVATIONS
- 2-5 GEOLOGIC CROSS-SECTION LOCATION
- 2-6 GEOLOGIC CROSS-SECTION A – A'
- 4-1 STEP DRAWDOWN TEST-UPPER SCREENED INTERVAL PUMPING WELL CONFIGURATION
- 4-2 CONSTANT DISCHARGE PUMPING TEST-UPPER SCREENED INTERVAL PUMPING WELL CONFIGURATION
- 4-3 INJECTION TEST-UPPER SCREENED INTERVAL INJECTION WELL CONFIGURATION
- 4-4 STEP DRAWDOWN TEST-LOWER SCREENED INTERVAL PUMPING WELL CONFIGURATION
- 4-5 DIPOLE FLOW TEST WELL CONFIGURATION
- 5-1 WATER LEVEL COMPARISON BETWEEN SAN DIEGO BAY AND OBSERVATION WELL MW45
- 5-2 OBSERVED GROUNDWATER ELEVATION AND BEST-FIT TIDAL INFLUENCE CURVE FOR WELL MW20
- 5-3 OBSERVED WATER LEVEL COMPARISON AMONG BAY TIDE, MW20 AND MW45
- 5-4 OBSERVED WATER LEVEL COMPARISON AMONG BAY TIDE, MW20 AND MW46
- 5-5 OBSERVED WATER LEVEL COMPARISON AMONG BAY TIDE, MW20 AND MW47
- 5-6 OBSERVED WATER LEVEL COMPARISON AMONG BAY TIDE, MW20 AND MW48
- 5-7 OBSERVED WATER LEVEL COMPARISON AMONG BAY TIDE, MW20 AND MW49
- 5-8 OBSERVED WATER LEVEL COMPARISON AMONG BAY TIDE, MW20 AND MW52
- 5-9 OBSERVED WATER LEVEL COMPARISON AMONG BAY TIDE, MW20 AND MW53
- 5-10 OBSERVED WATER LEVEL COMPARISON AMONG BAY TIDE, MW20 AND MW54
- 5-11 OBSERVED AND SIMULATED WATER LEVEL COMPARISON AMONG BAY TIDE, MW20, MW45 DURING THE PUMPING TEST
- 5-12 OBSERVED AND CORRECTED GROUNDWATER DRAWDOWN AT WELL MW45
- 5-13 OBSERVED AND CORRECTED GROUNDWATER DRAWDOWN AT WELL MW46
- 5-14 OBSERVED AND CORRECTED GROUNDWATER DRAWDOWN AT WELL MW47
- 5-15 OBSERVED AND CORRECTED GROUNDWATER DRAWDOWN AT WELL MW48
- 5-16 OBSERVED AND CORRECTED GROUNDWATER DRAWDOWN AT WELL MW49
- 5-17 OBSERVED AND CORRECTED GROUNDWATER DRAWDOWN AT WELL MW52
- 5-18 OBSERVED AND CORRECTED GROUNDWATER DRAWDOWN AT WELL MW53
- 5-19 OBSERVED AND CORRECTED GROUNDWATER DRAWDOWN AT WELL MW54
- 5-20 s/Q vs. Q PLOTS
- 5-21 s/Q vs. Q PLOTS
- 5-22 MAXIMUM DRAWDOWN VS. PUMPING RATE AND THE BEST FIT EQUATION
- 5-23 MAXIMUM WATER LEVEL RISE VS. RECHARGE RATE AND THE BEST FIT EQUATION
- 5-24 MAXIMUM DRAWDOWN VS. PUMPING RATE AND THE BEST FIT EQUATION
- 5-25 MW45 DRAWDOWN DATA PLOT AND TYPE CURVE MATCH

FIGURES (continued)

- 5-26 MW46 DRAWDOWN DATA PLOT AND TYPE CURVE MATCH
- 5-27 MW47 DRAWDOWN DATA PLOT AND TYPE CURVE MATCH
- 5-28 MW48 DRAWDOWN DATA PLOT AND TYPE CURVE MATCH
- 5-29 MW49 DRAWDOWN DATA PLOT AND TYPE CURVE MATCH
- 5-30 MW52 DRAWDOWN DATA PLOT AND TYPE CURVE MATCH
- 5-31 MW53 DRAWDOWN DATA PLOT AND TYPE CURVE MATCH
- 5-32 MW54 DRAWDOWN DATA PLOT AND TYPE CURVE MATCH
- 5-33 THE MEAN EQUIVALENT FRESH WATER HEAD CONTOUR AND HORIZONTAL
GROUNDWATER FLOW DIRECTION (UPPER AQUIFER ZONE, FOUR DATA POINTS,
AUGUST 1998)
- 5-34 THE MEAN EQUIVALENT FRESH WATER HEAD CONTOUR AND HORIZONTAL
GROUNDWATER FLOW DIRECTION (UPPER AQUIFER ZONE, THREE DATA POINTS,
AUGUST 1998)
- 5-35 THE MEAN EQUIVALENT FRESH WATER HEAD CONTOUR AND HORIZONTAL
GROUNDWATER FLOW DIRECTION (LOWER AQUIFER ZONE, THREE DATA POINTS,
AUGUST 1998)

TABLES

(All tables follow the text and figures of each section.)

Table

2-1	WELL SCREEN INTERVALS
3-1	START AND STOP TIMES FOR THE NoVOCs™ SYSTEM
4-1	TEST EXECUTION SUMMARY, STEP DRAWDOWN TEST – UPPER SCREEN INTERVAL
4-2	TEST EXECUTION SUMMARY, CONSTANT DISCHARGE PUMPING TEST – UPPER SCREEN INTERVAL
4-3	TEST EXECUTION SUMMARY, INJECTION TEST – UPPER SCREEN INTERVAL
4-4	TEST EXECUTION SUMMARY, STEP DRAWDOWN TEST – LOWER SCREEN INTERVAL
4-5	TEST EXECUTION SUMMARY, DIPOLE FLOW TEST
4-6	WATER QUALITY PARAMETERS, AQUIFER PUMPING TESTS
5-1	TIDAL INFLUENCE PARAMETER VALUES, TIDAL INFLUENCE STUDY OF APRIL 10 THROUGH 20, 1998
5-2	PARAMETERS USED IN TIDAL CORRECTION FOR THE CONSTANT DISCHARGE PUMPING TEST
5-3	AQUIFER TEST DATA AND THE NoVOCs™ WELL SPECIFIC CAPACITY
5-4	AQUIFER TEST DATA AND WELL EFFICIENCY
5-5	UPPER AQUIFER ZONE, CONSTANT DISCHARGE PUMPING TEST CONFIGURATION
5-6	CONSTANT DISCHARGE PUMPING TEST INFORMATION
5-7	AQUIFER HYDRAULIC PARAMETERS, UPPER AQUIFER CONSTANT DISCHARGE PUMPING TEST
5-8	MEAN GROUNDWATER AND EQUIVALENT FRESH-WATER HEADS

ACRONYMS AND ABBREVIATIONS

bgs	Below ground surface
cm/sec	Centimeters per second
CPT	Cone penetrometer test
DCA	Dichloroethane
DCE	Dichloroethene
DFT	Dipole flow test
DNAPL	Dense nonaqueous phase liquid
Eh	Reduction/oxidation potential
EPA	U. S. Environmental Protection Agency
ft/day	Feet per day
ft/ft	Feet per foot
ft ² /day	Square feet per day
gpm	Gallons per minute
gpm/ft	Gallons per minute per foot
g/cm ³	Grams per cubic centimeter
IR	Installation Restoration
MACTEC	MACTEC Inc.
mg/kg	Milligrams per kilogram
mg/L	Milligrams per liter
MLLW	Mean lower low water
mv	Millivolts
NAS	Naval Air Station
NOAA	National Oceanic and Atmospheric Administration
NTU	Nephelometric turbidity units
ORD	Office of Research and Development
OSWER	Office of Solid Waste and Emergency Response
PAH	Polynuclear aromatic hydrocarbon
PCE	Tetrachloroethene
psi	Pounds per square inch
PVC	Polyvinyl chloride
scfm	Standard cubic feet per minute
SITE	Superfund Innovative Technology Evaluation
SVOC	Semivolatile organic compound
1,1-TCA	1,1-Trichloroethane
TDS	Total Dissolved Solids
TCE	Trichloroethene

ACRONYMS AND ABBREVIATIONS (continued)

Tetra Tech	Tetra Tech EM Inc.
VOC	Volatile organic compound
Fmhos/cm	Micromhos per centimeter

EXECUTIVE SUMMARY

In support of the U.S. Environmental Protection Agency (EPA) Superfund Innovative Technology Evaluation (SITE) Program, Tetra Tech EM Inc. (Tetra Tech) is evaluating the MACTEC Inc. (MACTEC) NoVOCs™ in-well volatile organic compound (VOC) stripping system at Installation Restoration (IR) Site 9 at Naval Air Station (NAS) North Island in San Diego, California. The NoVOCs™ system is a patented recirculating well that is designed for the in situ remediation of groundwater contaminated by VOCs.

In April 1998, the Navy initiated operation of the NoVOCs™ system. By June 1998, the pumping rate had been reduced from the design rate of 25 gallons per minute (gpm) to approximately 5 gpm because not all water pumped at higher rates could be injected into the aquifer. The NoVOCs™ system was shut down on June 19, 1998, to evaluate the cause of the problem. Suspected causes for the poor injection performance included (1) biofouling or scaling of the screen intervals and formation near the NoVOCs™ system, (2) design problems with the NoVOCs™ well, in particular the sizing of the recharge screen, and (3) possible differences in hydraulic characteristics between the upper and lower portions of the aquifer.

EPA directed Tetra Tech to conduct the hydrogeological study at the demonstration site to provide information on the recharge capacity of the NoVOCs™ system and the hydraulic characteristics of the aquifer in the vicinity of the NoVOCs™ system. The groundwater study included: (1) a tidal influence study to evaluate natural variations in water level at the site due to tides in San Diego Bay, and (2) a series of groundwater pumping tests in the shallow and deep portions of the aquifer, including step drawdown tests, a 32-hour constant pumping rate test, an injection test, and a dipole flow test to evaluate the aquifer characteristics in the vicinity of the NoVOCs™ system.

The hydrogeological investigation of the aquifer treated by the NoVOCs™ system has yielded valuable information regarding the hydraulic characteristics of the aquifer, pumping and injection capacities of the NoVOCs™ well, and defects in the NoVOCs™ well. The conclusions of the investigation are as follows:

- 1) The tested aquifer is in good hydraulic communication with San Diego Bay. Groundwater levels at different depths within the aquifer are all influenced by tidal fluctuations in San Diego Bay. The tidal influence of the aquifer is demonstrated by the drawdown data collected from the observation wells during the constant discharge pumping test of the NoVOCs™ well.

- 2) The groundwater levels must be corrected for tidal effects to allow the calculation of aquifer parameters and mean groundwater elevations. In addition, the mean groundwater elevations must be corrected for density effects to allow determination of groundwater flow patterns. After tidal and density corrections, the mean equivalent fresh water head contour maps were generated.
- 3) The aquifer hydraulic tests show that the upper and lower aquifer zones are in good hydraulic communication. Drawdown responses were observed in both aquifer zones during the constant discharge pumping test in the upper aquifer zone and the step-drawdown tests in the upper and lower aquifer zones.
- 4) Groundwater generally flows to the west or northwest in both of the upper and lower aquifer zones. The horizontal hydraulic gradient in both aquifer zones is relatively flat, ranging from 0.005 to 0.01.
- 5) Two methods were developed for tidal correction of groundwater drawdown data obtained during the constant discharge pumping test. The methods involve using the tidal influence study data collected in April 1998 to calculate the tidal efficiency and time lag for each of the observation wells. The estimated tidal efficiency ranges from 0.05 to 0.1 in different tidal cycles at different wells; and time lags range from 46 to 96 minutes.
- 6) Observed drawdown data collected during the constant discharge pumping test were corrected using the two new tidal correction methods. The corrected drawdown (that is, drawdown data with the tidal effects removed) using both methods correlates well with each other and reflects typical pumping test responses. The corrected drawdown matches reasonably well with Neuman type curves for the aquifer parameter estimation.
- 7) The aquifer hydraulic parameters were estimated based on the tidally corrected groundwater drawdown data for the constant discharge pumping test. The average hydraulic conductivity was estimated as 29 feet per day (ft/day) or 0.01 centimeters per second (cm/sec). The average aquifer storativity and specific yield are 0.004 and 0.07, respectively. The average ratio of horizontal to vertical hydraulic conductivity is estimated at 5.7.
- 8) Specific capacity and efficiency of the NoVOCsTM well were estimated based on the step-drawdown tests and water injection test conducted at the NoVOCsTM well. The calculated average specific capacities are 1.48 gallons per minute per foot (gpm/ft) for the upper screened interval during pumping, 1.50 gpm/ft during injection, and 3.22 gpm/ft for the lower screened interval during pumping. The calculated average well efficiencies are 82 percent for the upper screened interval during pumping, 97 percent during injection, and 91 percent for the lower screened interval during pumping. The 97-percent well efficiency for the upper screened injection is for injection of clean tap water.
- 9) The radius of influence, as defined as the distance from the pumping well to an observation well at which drawdown can be positively identified (0.01 feet), was at least 100 feet during the constant discharge pumping test with a pumping rate of 20 gallons per minute (gpm).
- 10) No positive (recharge) or negative (flow barrier) boundaries are evident from the constant discharge pumping test data.

- 11)** The injection test results show that the maximum flow of clean tap water that can be injected through the upper screen of the NoVOCs™ well is 25 gpm. At that injection rate, the water level will rise 17 feet and reach the ground surface.
- 12)** The video survey of the NoVOCs™ well revealed a manufacturing defect in the upper well screen. The screen slots are unevenly cut, and about 30 percent of the slots do not completely penetrate the PVC casing. This defect affects the well efficiency of the upper screened interval and may reduce the available water level rise in the NoVOCs™ well during recharge to the aquifer through the upper screen.
- 13)** The video survey also revealed significant fouling of the NoVOCs™ well screens by iron precipitation and microbiological growth. Such fouling may impair the performance of the NoVOCs™ system by obstructing the well screen and filter pack.
- 14)** The findings of the aquifer tests and tidal study of the aquifer treated by the NoVOCs™ system indicate that the aquifer hydraulic conditions are suitable for application of the NoVOCs™ technology. The NoVOCs™ well as designed should be able to extract and inject a flow rate of 20 gpm based on the aquifer hydraulic characteristics.

1.0 INTRODUCTION

In support of the U.S. Environmental Protection Agency (EPA) Superfund Innovative Technology Evaluation (SITE) Program, Tetra Tech EM Inc. (Tetra Tech) is evaluating the MACTEC Inc. (MACTEC) NoVOCsTM in-well volatile organic compound (VOC) stripping system at Installation Restoration (IR) Site 9 at Naval Air Station (NAS) North Island in San Diego, California. The NoVOCsTM system is a patented recirculating well that is designed for the in situ remediation of groundwater contaminated by VOCs. A vicinity map, site location map, and site plan are presented as Figures 1-1, 1-2, and 1-3.

In April 1998, the Navy initiated operation of the NoVOCsTM system. The EPA SITE Program evaluation of the NoVOCsTM system also began in April 1998, and included collection of air and groundwater samples from the NoVOCsTM system and surrounding monitoring points. The evaluation was conducted in accordance with the draft final "Technology Evaluation Plan/Quality Assurance Project Plan for the MACTEC NoVOCsTM Technology Evaluation at NAS North Island" (Tetra Tech 1998). By June 1998, the pumping rate had been reduced from the design rate of 25 gallons per minute (gpm) to approximately 5 gpm because not all water pumped at higher rates could be injected into the aquifer. Based on discussions between the Navy and the technology developer, the system was shut down on June 19, 1998, to evaluate the cause of the poor injection performance. Suspected causes for the poor injection performance included (1) biofouling or scaling of the screen intervals and formation near the NoVOCsTM system, (2) design problems with the NoVOCsTM well, in particular the sizing of the recharge screen, and (3) possible differences in hydraulic characteristic between the upper and lower portions of the aquifer. This report presents the results of a hydrogeological investigation to assess the hydraulic characteristics of the aquifer that may affect the NoVOCsTM system performance.

EPA directed Tetra Tech to conduct the hydrogeological study at the demonstration site to obtain information on the recharge capacity of the NoVOCsTM system and the aquifer hydraulic characteristics in the vicinity of the NoVOCsTM system. The hydrogeological study included: (1) a tidal influence study to evaluate natural variations in water level at the site due to tides in San Diego Bay, and (2) a series of aquifer hydraulic tests in the shallow and deep portions of the aquifer, including step drawdown tests, a 32-hour constant discharge pumping test, an injection test, and a dipole flow test to evaluate the aquifer characteristics in the vicinity of the NoVOCsTM system.

This report presents background information on the NoVOCs™ system and IR Site 9, documents the field methods and procedures implemented during the groundwater study, presents the study results, discusses the data analysis and interpretation, and presents conclusions based on the information obtained. The remainder of this section presents information on the EPA SITE program and the hydrogeological study objectives.

1.1 SITE PROGRAM

SITE was established by EPA's Office of Solid Waste and Emergency Response (OSWER) and Office of Research and Development (ORD) in response to the Superfund Amendments and Reauthorization Act of 1986. The SITE program was established to accelerate the development, evaluation, and use of innovative technologies to remediate hazardous waste sites. The evaluation portion of the SITE program focuses on technologies in the pilot- or full-scale development stage. The evaluations are intended to collect performance data of known quality. In support of this portion of the program, a series of aquifer tests were conducted to assist in evaluating the NoVOCs™ system by providing a greater understanding of the site hydrogeology.

1.2 PROJECT OBJECTIVES

The overall objective of the groundwater study was to assess hydraulic characteristics of the aquifer in the vicinity of the NoVOCs™ system at the demonstration site. In support of this objective, the specific objectives of the groundwater study were to: (1) document groundwater elevation change (water level) in selected wells due to tidal influence, and (2) conduct a series of aquifer hydraulic tests to assess hydrogeologic conditions in the vicinity of the NoVOCs™ system.

Aquifer hydraulic tests of the NoVOCs™ well (IW-01) were conducted to estimate or assess the following:

- Well efficiencies of the two screened intervals of the NoVOCs™ well: the outer casing is screened at 43 to 47 feet below ground surface (bgs) (-21.3 to -25.3 feet relative to mean lower low water [MLLW]) and 72 to 78 feet bgs (-50.3 to -56.3 feet MLLW).
- Hydraulic parameters of the upper and lower portions of the aquifer, including estimation of hydraulic conductivity, transmissivity, storativity, and aquifer anisotropy.
- The radius of influence established during pumping.

- The presence of hydraulic barriers that may affect hydraulic communication between the upper and lower zones of the aquifer.

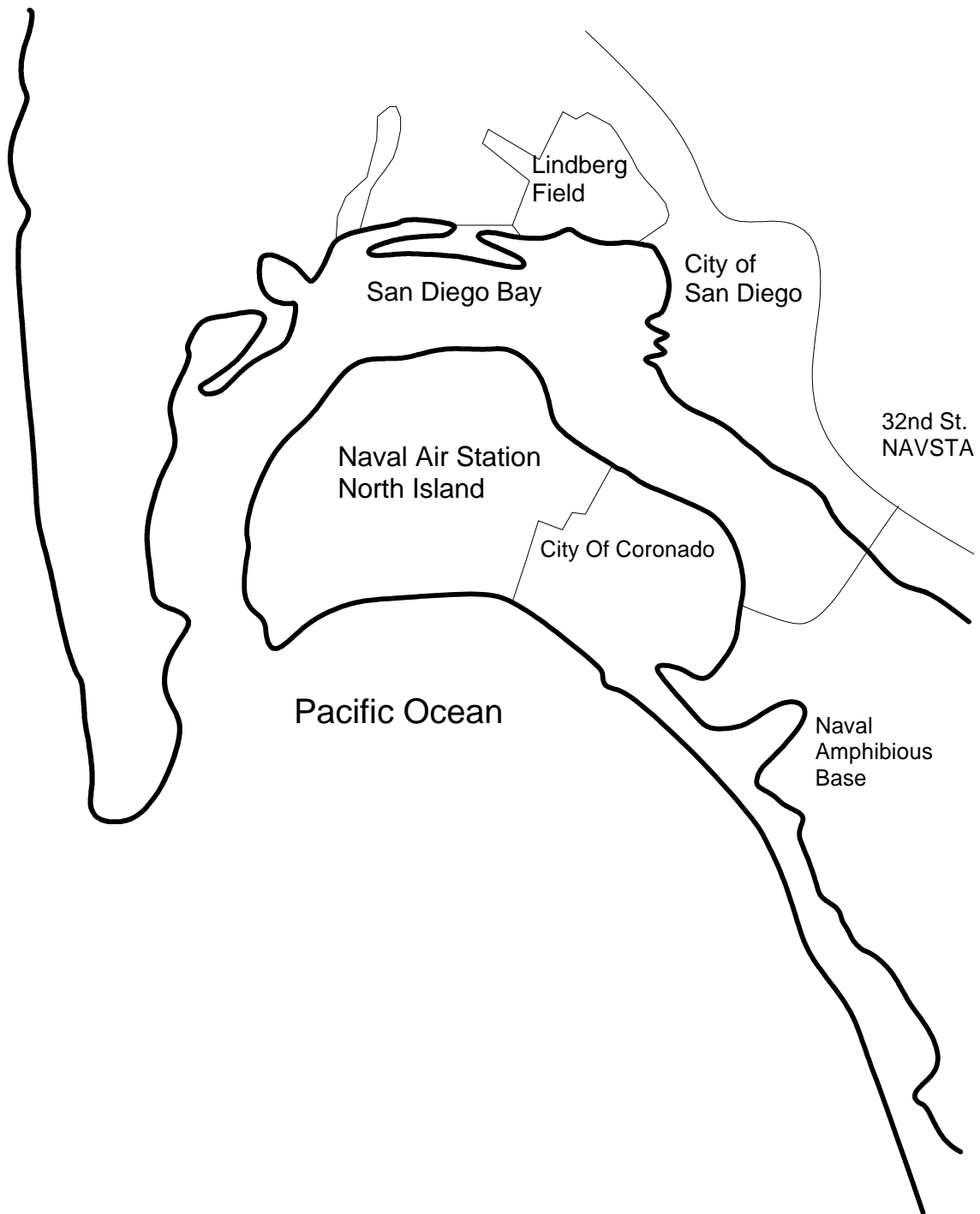

NAS NORTH ISLAND SITE 9
NoVOCs™ TECHNOLOGY EVALUATION

**FIGURE 1-1
VICINITY MAP**

 Tetra Tech EM Inc.

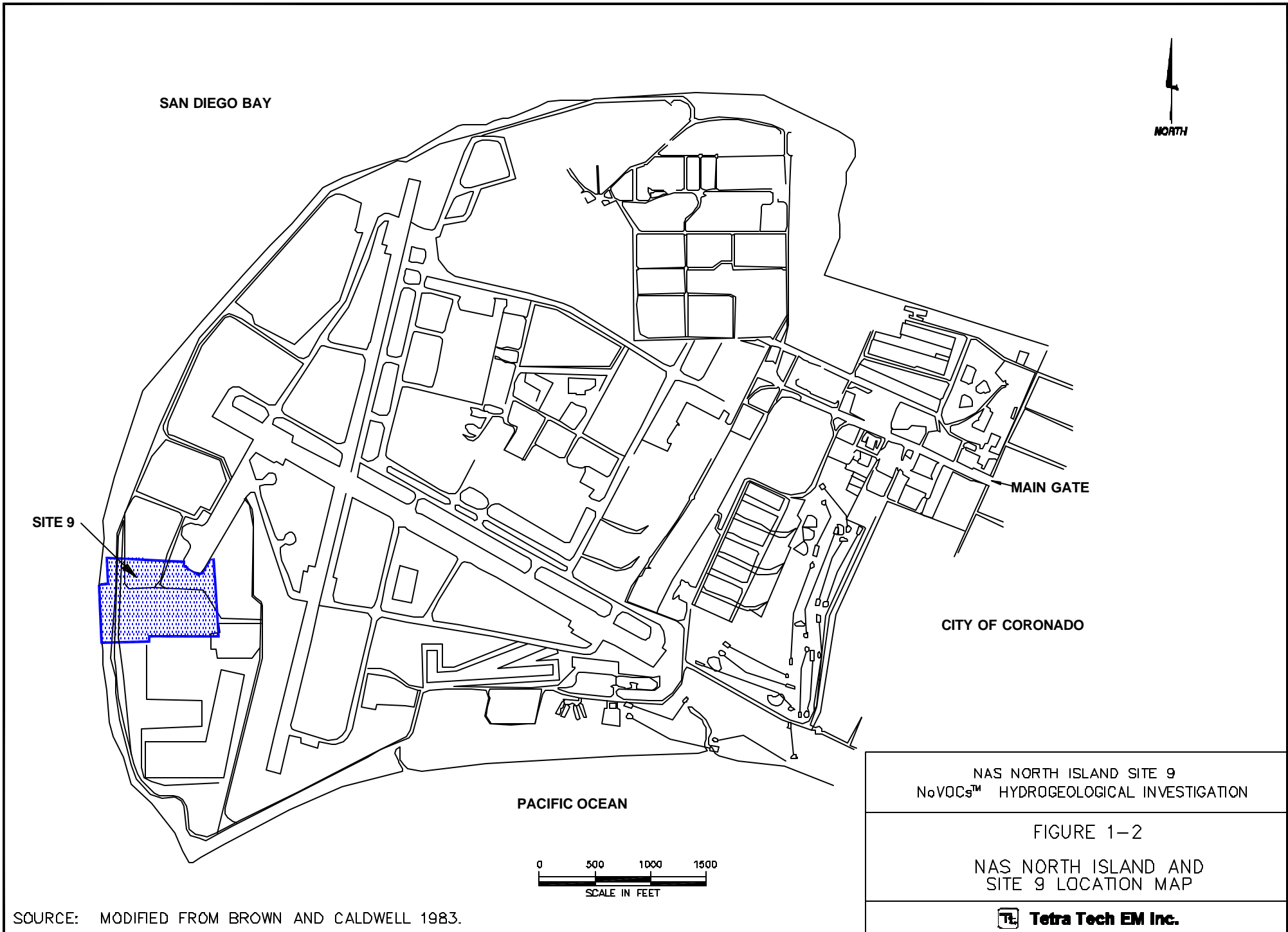

SAN DIEGO BAY



MAIN GATE

SITE 9

CITY OF CORONADO

PACIFIC OCEAN



NAS NORTH ISLAND SITE 9
NoVOCs™ HYDROGEOLOGICAL INVESTIGATION

FIGURE 1-2





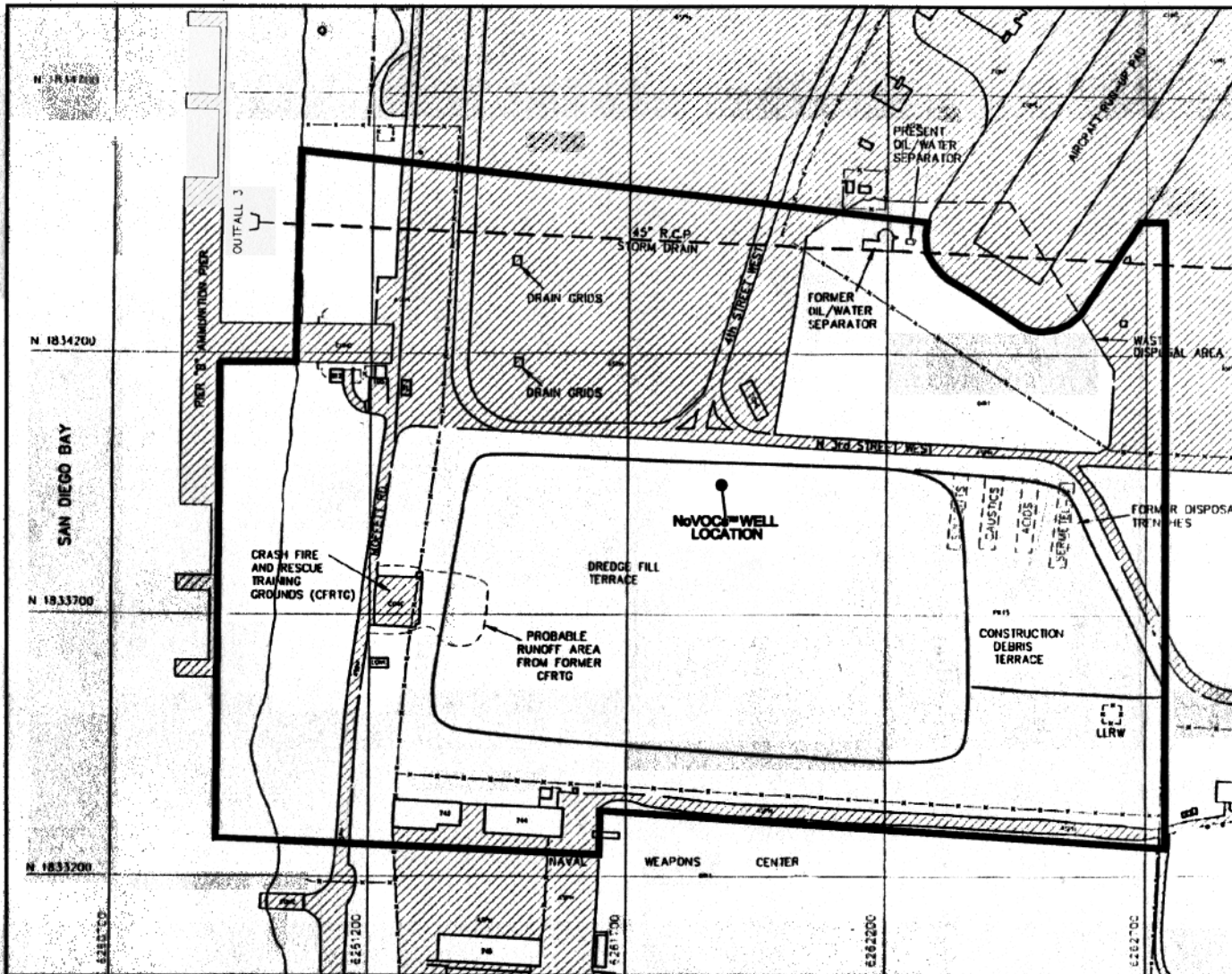

NAS NORTH ISLAND AND
SITE 9 LOCATION MAP



SOURCE: MODIFIED FROM BROWN AND CALDWELL 1983.

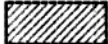

LEGEND

-  FENCE
-  ROAD AND STREET
-  BUILDING
-  PAVEMENT (CONCRETE OR ASPHALT)
-  TERRACE BORDERS
-  LLRW
-  STORM DRAIN
-  SITE 9 BOUNDARY

NOTES:

1. BASE MAP ADAPTED FROM PHOTGRAMMETRY BY BECHTEL NATIONAL, INC., 1984.
2. ELEVATION DATUM IS MEAN LOWER LOW WATER.
3. COORDINATES ARE IN THE CALIFORNIA COORDINATE SYSTEM (1983) ZONE 6 BASED ON THE NORTH AMERICAN DATUM (1983).



NAS NORTH ISLAND SITE 9
NoVOCS™ HYDROGEOLOGICAL INVESTIGATION

FIGURE 1-3
SITE 9 CHEMICAL WASTE DISPOSAL AREAS

 Tetra Tech EM Inc.

2.0 BACKGROUND

This section describes the NoVOCs™ system and the associated groundwater monitoring system at NAS North Island. This section also provides information on site conditions, including site history, topography, geology, hydrogeology, and soil and groundwater contamination. In addition, this section identifies the locations and describes the construction of wells installed to investigate the hydrogeology of the site.

2.1 THE NoVOCs™ SYSTEM

This section provides a general description of the NoVOCs™ system at NAS North Island and describes the groundwater monitoring system for evaluating the NoVOCs™ system performance.

2.1.1 General Description

The NoVOCs™ system is a patented in-well stripping process (U.S. Patent No. 5,180,503) for in situ removal of VOCs from groundwater. A diagram of the treatment process is shown in Figure 2-1. In this process, air injected into a specially designed well simultaneously creates an air-lift pump and an in situ stripping reactor to circulate and remediate groundwater (EG&GE 1996).

The NoVOCs™ system consists of a well casing installed in the contaminated saturated zone, with two screened intervals below the water table and an air injection line extending into the groundwater within the well. Contaminated groundwater enters the well through the lower screen and is pumped upward within the well by pressurized air supplied through the air injection line, creating an air-lift pump effect. As the water is air-lifted within the well, dissolved VOCs in the water volatilize into the rising air bubbles and are transported to the upper portion of the well. The treated water rises to a deflector plate and is forced out the upper screen. The treated water is recharged to the aquifer, and the stripped VOC vapors are removed from the subsurface by a vacuum applied to the upper well casing (EG&GE 1996). The stripped vapors then are treated by the Thermatrix flameless oxidation process. The equipment used to operate the NoVOCs™ system, including blowers, control panel, and air temperature, pressure, and flow rate gauges is housed in an on-site control trailer.

2.1.2 NoVOCs™ Monitoring System at NAS North Island

At NAS North Island, one NoVOCs™ well has been installed to remediate a portion of the aquifer downgradient of a contaminant source area. Assuming the designed pumping rate of 25 to 30 gpm and a total air flow rate of 120 standard cubic feet per minute (scfm), the radius of influence of the NoVOCs™ well for this site is predicted to be at least 90 feet (EG&GE 1997). To evaluate the accuracy of this prediction and to obtain information on the horizontal and vertical extent of the NoVOCs™ treatment cell and assess changes in contaminant concentrations within the treatment cell, two ½-inch outer diameter piezometers (PZ-01 and PZ-02) and 10 2-inch outer diameter groundwater observation wells (MW-45 through MW-54) were installed.

Figure 2-2 shows a plan view of the location of the NoVOCs™ well and observation wells. Figure 2-3 shows a generalized cross-section of the NoVOCs™ well, piezometers, and observation wells. The two piezometers were installed within the sand pack of the NoVOCs™ well: one adjacent to the NoVOCs™ recharge screen (PZ-01), and one adjacent to the NoVOCs™ intake screen (PZ-02). The natural groundwater flow direction across the site is generally to the west. Seven cross-gradient observation wells were installed at four distances from the NoVOCs™ well, as follows: a cluster of three wells 30 feet from the NoVOCs™ well (observation wells MW-45, MW-46, and MW-47), a well pair 60 feet from the NoVOCs™ well (observation wells MW-48 and MW-49), and single observation wells 90 and 105 feet from the NoVOCs™ well (observation wells MW-50 and MW-51). Two downgradient observation wells (MW-52 and MW-53) were installed as a pair approximately 100 feet from the NoVOCs™ well, and a single observation well (MW-54) was also installed 100 feet upgradient of the NoVOCs™ well. Each observation well was screened at one of the following three intervals: at the top of the treatment zone (between approximately 41 and 47 feet bgs [-19.1 to -25.0 feet MLLW]), in the middle of the treatment zone (between approximately 49 and 62 feet bgs [-35.1 to -40.4 feet MLLW]), and at the bottom of the treatment zone (between approximately 67 and 78 feet bgs [-43.6 to -58.0 feet MLLW]). A summary of well screen intervals for the individual wells is presented in Table 2-1.

2.2 SITE HISTORY

NAS North Island is the largest naval aviation complex on the West Coast and is home to two aircraft carriers and the Third Fleet flagship, USS Coronado. NAS North Island is located at the northern end of the peninsula that forms San Diego Bay and is bordered by the City of Coronado to the east, the Pacific Ocean to the south, and San Diego Bay to the north and west (Figure 1-1). The 2,806-acre complex,

officially commissioned in 1917, provides aviation support services to the fleet, aircraft maintenance, airfield operations, pierside services, and logistics. The mission of NAS North Island is to maintain and operate facilities and to provide services and materiel that support operation of aviation activities and units of the Operating Forces of the Navy, as well as other units as designated by the Chief of Naval Operations.

Past hazardous waste disposal practices at NAS North Island have resulted in soil and groundwater contamination. The Navy has undertaken investigations to determine the extent of contamination and possible cleanup methods as part of the IR Program. Under the IR Program, 14 contaminated areas have been designated IR sites, one of which is Site 9 (Figure 1-2).

Site 9, the 40-acre former chemical waste disposal area, is located on the western end of NAS North Island. Site 9 operated from the 1940s to the mid-1970s and consisted of three major waste disposal areas: a shallow pit used for disposal of liquid wastes (located within the waste disposal area shown in Figure 1-3); four parallel trenches each containing different types of wastes (solvents, caustics, acids, and semisynthetics consisting of ceramic and metallic compounds); and a large unimproved area used for burying drums containing unidentified chemical wastes located south of the NoVOCs™ well. An estimated 32 million gallons of waste were disposed of at Site 9 over its 30 years of operation (Jacobs 1995a).

Contamination from these disposal areas has migrated to the underlying groundwater. Although there is no official history of chemical disposal for most of Site 9 outside of the three disposal areas, groundwater contamination is widespread throughout the site. Elevated levels of chlorinated solvents and their breakdown products, as well as petroleum hydrocarbons and metals, are present in groundwater at Site 9. Based on the high dissolved concentrations of chlorinated solvent compounds, the presence of dense nonaqueous phase liquids (DNAPL) in the subsurface is suspected.

The Navy selected a location immediately south of the intersection of 4th Street West and North 3rd Street West to install the NoVOCs™ system (Figure 1-3). Cone penetrometer test (CPT) boreholes advanced at the proposed NoVOCs™ location provided additional characterization of subsurface lithology and confirmed that significant groundwater contamination was present (Bechtel 1998).

2.3 SITE TOPOGRAPHY

The topography of the northern half of Site 9 is relatively flat with an elevation of approximately 13 feet above MLLW. It has virtually no relief and is covered by asphalt paving. The southern half of the site is unpaved, and is almost entirely covered by a terrace composed of hydraulic dredge spoils. The terrace has an elevation of approximately 23 feet above MLLW along its north face and slopes gently southward to approximately 18 feet above MLLW (Jacobs 1994). Topographic elevations and surface features are shown in Figure 2-4. The NoVOCs™ well is located on the terrace at a surface elevation of approximately 22 to 23 feet above MLLW.

2.4 REGIONAL AND SITE GEOLOGY

This section discusses the regional and site geology for Site 9.

2.4.1 Regional Geology

NAS North Island is situated in the coastal portion of the Peninsular Range Geologic Province. This region is underlain by a basement complex of late Cretaceous undifferentiated igneous rocks of the Southern California Batholith and Jurassic prebatholithic metavolcanic rocks. The basement complex is nonconformably overlain by a sedimentary succession of marine and nonmarine rocks that were deposited within the San Diego embayment. These rocks range in age from Late Cretaceous to Recent. The most abundant deposits of the embayment are gently folded and faulted Eocene marine, lagoonal, and nonmarine rocks that thin eastward and trend northwest.

2.4.2 Site Geology

Site 9 is underlain by artificial fill to a depth of approximately 15 feet bgs in the vicinity of the NoVOCs™ well. The artificial fill in this area varies in thickness. The terrace is composed of hydraulic fill derived from dredging the San Diego Bay and consists of fine-grained, loose sand. In addition, in the immediate vicinity of the site, the former Whaler's Bight, a shallow lagoon formerly present at the western edge of North Island, was filled with sediments during the early part of the twentieth century. Below the fill material is the Bay Point Formation, a poorly consolidated, fine- and medium-grained fossiliferous sandstone (Kennedy 1975).

The depositional environment of the site was lagoonal and shallow marine. Sediment accumulated on the southern portion of North Island generally from northward transport of sediment along the shore. As described below, most of the uppermost sediments at the site are composed of fine-grained sand, with varying amounts of silt and medium-grained sand. Two thin silt and clay layers are present in the subsurface at the site and are likely to be continuous in the vicinity of the site, based on observations in the numerous borings and wells installed at the site (Bechtel 1998).

The first fine-grained layer is a thin (2 to 5 feet thick) clay, silt, and clayey sand layer designated as “A clay/silt” (Jacobs 1994). A clay/silt occurs at approximately 35 to 40 feet bgs and is present beneath Site 9 (Jacobs 1994). Recent investigations by Bechtel have indicated that the A clay/silt is continuous from the proposed NoVOCs™ well locations west to the shoreline wells. Beneath the unconsolidated sediments is a sandstone layer at approximately 90 feet bgs. The second layer is the B clay, located approximately 105 feet bgs that also appears to be continuous in the vicinity of the site. The location of a geologic cross-section is shown in Figure 2-5, and the cross-section depicting the subsurface geology of the site is shown in Figure 2-6.

Boring S9-SB-34 located near the NoVOCs™ well encountered mostly sand and silty sand. The A clay/silt was encountered at 35.5 feet bgs, dense sands were encountered between 60 and 61 feet bgs and 65 to 67.5 feet bgs, and a thin cemented sandstone layer was encountered at 79 feet bgs. In addition, the sand fractions of the sands and silty sands ranged from very fine- to coarse-grained and contained various quantities of shell fragments. The log for boring S9-SB-34 is provided in Appendix A.

2.5 SITE HYDROGEOLOGY

The generally accepted hydrogeologic model for islands and peninsulas surrounded by salt water is a lens-shaped body of fresh water resting isostatically atop salt water because of density differences. At Site 9, groundwater occurs at approximately 8 feet bgs (5 feet above MLLW). The upper 110 feet of the saturated zone contains an unconfined aquifer with a thin (5 to 20 feet), discontinuous fresh water lens, a brackish mixing zone (30 to 100 feet), and a seawater wedge intruding inland. Values for some of the hydrogeological parameters of the site are as follows (Jacobs 1995b):

- Hydraulic Gradient: 0.0008 foot per foot (ft/ft) over most of the site, but steepens near the shoreline to 0.006 ft/ft
- Transmissivity: 1,195 square feet per day (ft²/day)

- Specific yield: 3.2×10^{-1} (dimensionless)
- Hydraulic Conductivity: 12 feet per day (ft/day) or 4.2×10^{-3} centimeters per second (cm/sec)
- Effective Porosity: 0.25 (dimensionless)

In general, the hydraulic gradient is toward the west, varying between southwest and northwest. The groundwater is tidally influenced.

The distribution of groundwater contamination suggests that the general flow of groundwater is toward the west. Contaminants associated with the site have been detected in pore water of San Diego Bay, west of Site 9 (SPARWAR Systems Center 1998). A survey of pore water concentrations of VOCs was conducted in the spring of 1998 in the upper 5 feet of sediment adjacent to and west of Site 9. The results of the survey documented that VOCs were present in the pore water at depths of approximately 20 to 30 feet below MLLW. The data suggest that contaminants are migrating west from Site 9, at a depth consistent with the A clay/silt layer, and discharging to the bay through pore water interchange with the bay water (Bechtel 1998).

2.6 SOIL AND GROUNDWATER CONTAMINATION

Based on findings from previous investigations at the site (Jacobs 1995a,b), high concentrations of chlorinated solvents, chlorinated solvent breakdown products, petroleum hydrocarbons, and metals are present in the saturated and unsaturated zones. The major contaminants detected in groundwater are chlorinated aliphatic hydrocarbon solvents (tetrachloroethene [PCE], trichloroethene [TCE], and 1,1,1-trichloroethane [1,1,1-TCA]) and their breakdown products (dichloroethane [DCA], dichloroethene [DCE], and vinyl chloride); lower concentrations of aromatic hydrocarbons (benzene, toluene, ethylbenzene, and xylene); and heavy metals. Because of the high concentrations of chlorinated solvent compounds in groundwater above the B clay, DNAPL occurrences are suspected at several locations beneath Site 9. If present, DNAPL may act as a long-term source of dissolved-phase contamination in the unconfined aquifer.

Contaminants in soils consist of heavy metals, VOCs, and semivolatile organic compounds (SVOC). Eighteen priority pollutant VOCs were detected in soil samples with individual compound concentrations of up to 3,600 milligrams per kilogram (mg/kg). Fourteen priority pollutant SVOCs, including

polynuclear aromatic hydrocarbons (PAH), were detected in soil samples with individual compound concentrations up to 1,668 mg/kg. In the former release areas, soils reportedly are virtually saturated with VOCs (Jacobs 1995a). In addition, large quantities of VOCs are believed to have evaporated from saturated soils and groundwater into the vadose zone. Elevated levels of TCE, PCE, and toluene have been detected in soil gas within the vadose zone.

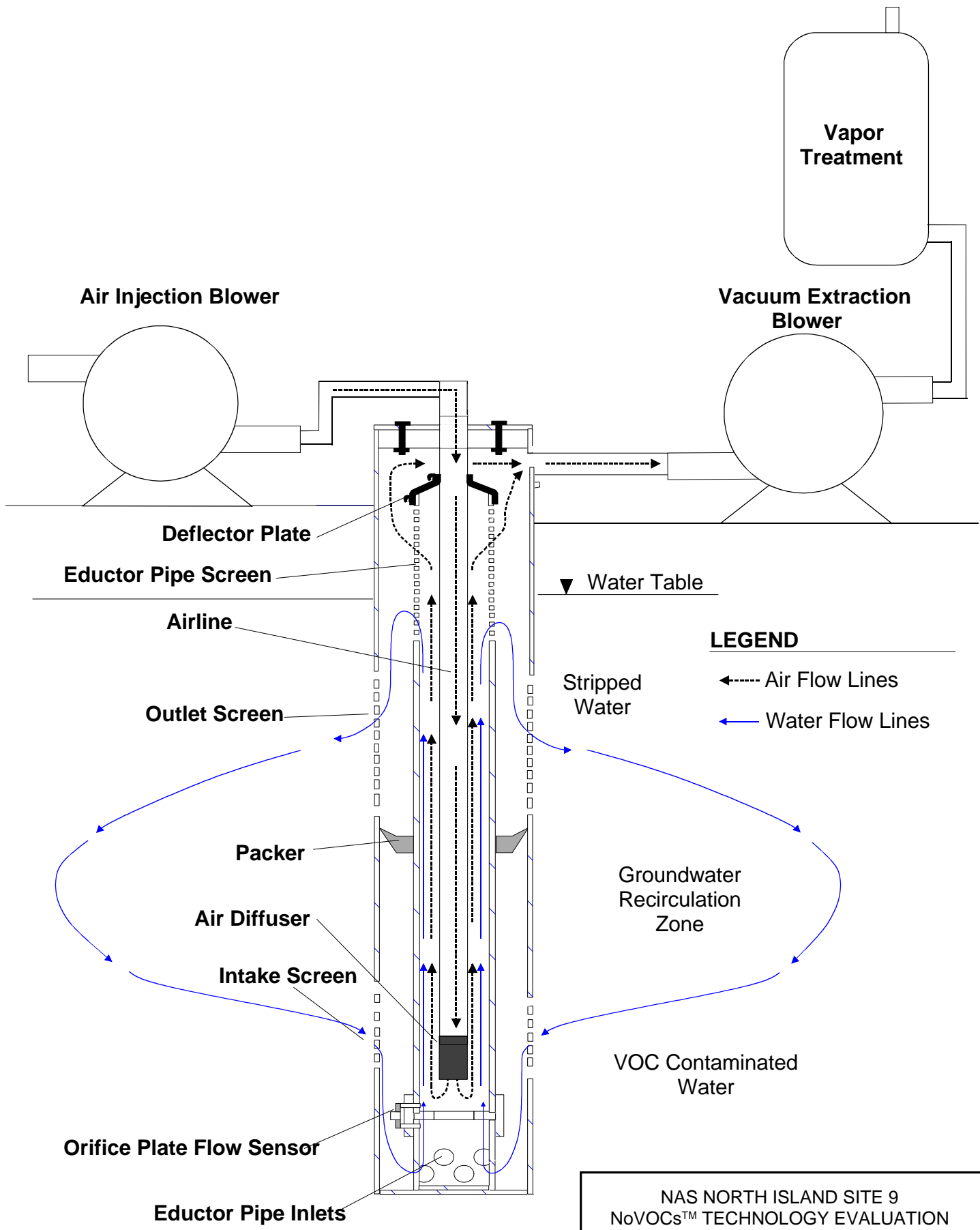

Not to scale

NAS NORTH ISLAND SITE 9
NoVOCs™ TECHNOLOGY EVALUATION

FIGURE 2-1
NoVOCs™ SYSTEM



4th STREET WEST

EXISTING SVE PAD

NoVOCS-THERMATRIX
EQUIPMENT PAD

PROPANE TANKS

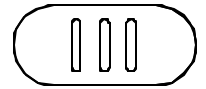

N 3rd STREET WEST

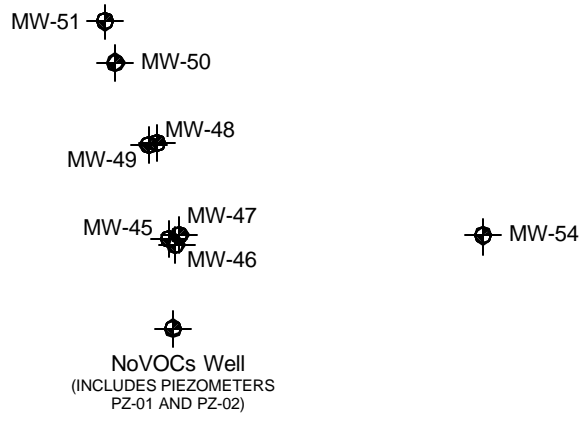

LEGEND



APPROXIMATE LOCATION OF
MONITORING WELL OR NoVOCS WELL





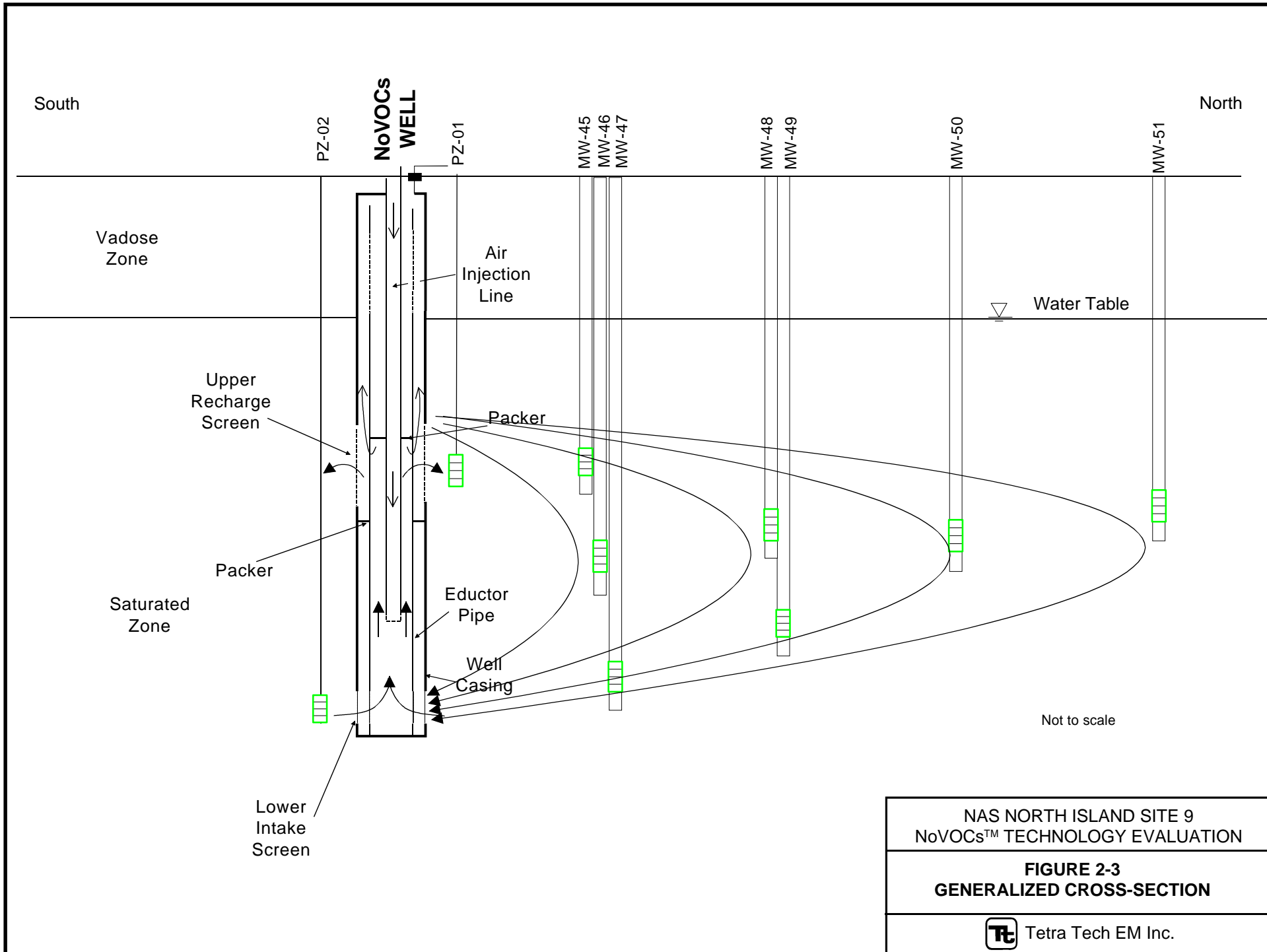

NAS NORTH ISLAND SITE 9
NoVOCS™ HYDROGEOLOGICAL INVESTIGATION

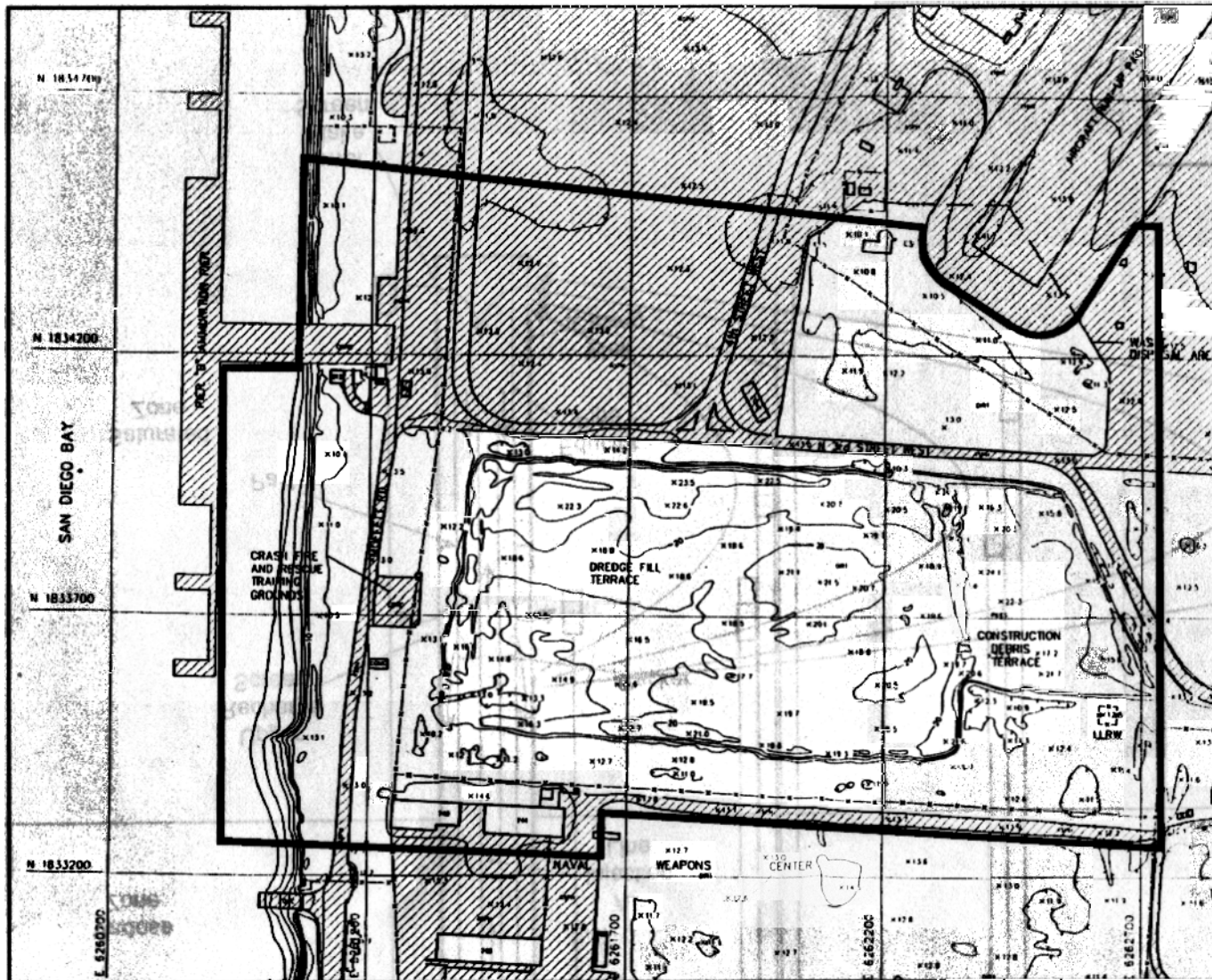
FIGURE 2-2
WELL LOCATIONS





LEGEND

-  20 CONTOUR LINE
-  FENCE
-  ROAD AND STREET
-  BUILDING
- X 12.3 SPOT ELEVATION
-  PAVEMENT (CONCRETE OR ASPHALT)
- LLRW LOW-LEVEL RADIOACTIVE WASTE STORAGE AREA
- SITE 9 BOUNDARY

NOTES:

1. BASE MAP ADAPTED FROM PHOTGRAMMETRY BY BECHTEL NATIONAL, INC., 1984.
2. ELEVATION DATUM IS MEAN LOWER LOW WATER.
3. COORDINATES ARE IN THE CALIFORNIA COORDINATE SYSTEM (1983) ZONE 6 BASED ON THE NORTH AMERICAN DATUM (1983).



NAS NORTH ISLAND SITE 9
NoVOCs™ HYDROGEOLOGICAL INVESTIGATION.

FIGURE 2-4

SITE 9 TOPOGRAPHIC ELEVATIONS

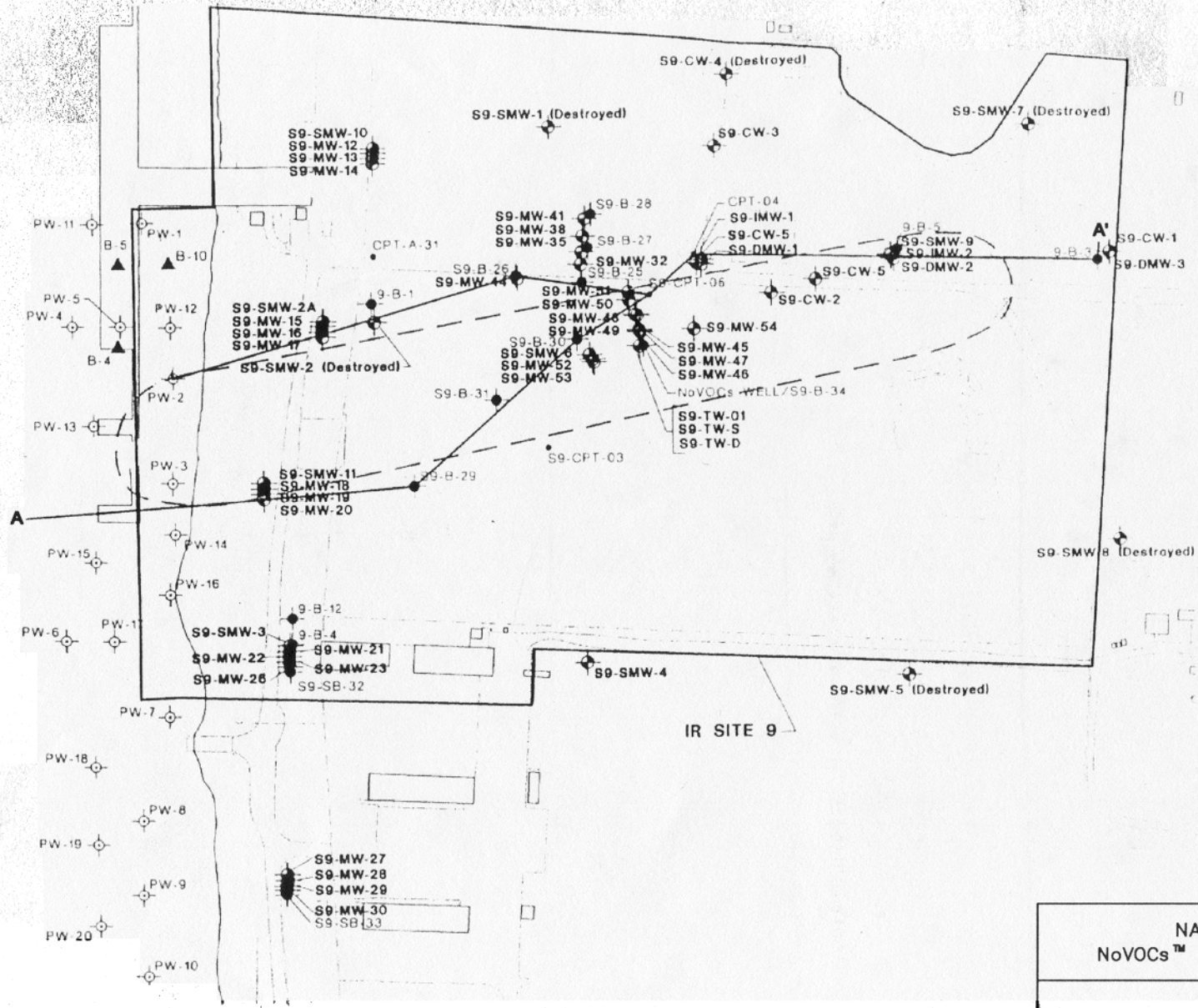

- LEGEND**
- MONITORING WELLS
 - OFF-SHORE PORE WATER SAMPLE
 - GEOTECHNICAL BORING FROM AMMUNITIONS PIER CONSTRUCTION, 1975
 - CONTINUOUS COREHOLE
 - CONE PENETROMETER TEST
 - IRP SITE BOUNDARY
 - ESTIMATED EXTENT OF VOC MIGRATION PATHWAY AT DEPTH OF 65' TO 80' BGS
 - GEOLOGIC GROSS SECTION LINE

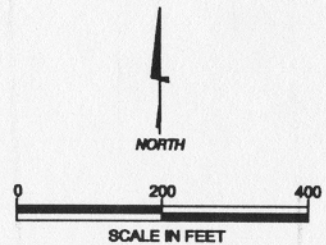

NAS NORTH ISLAND SITE 9
NoVOCs™ HYDROGEOLOGICAL INVESTIGATION

FIGURE 2-5

GEOLOGIC CROSS-SECTION LOCATION

SOURCE: MODIFIED FROM BECHTEL (1998)

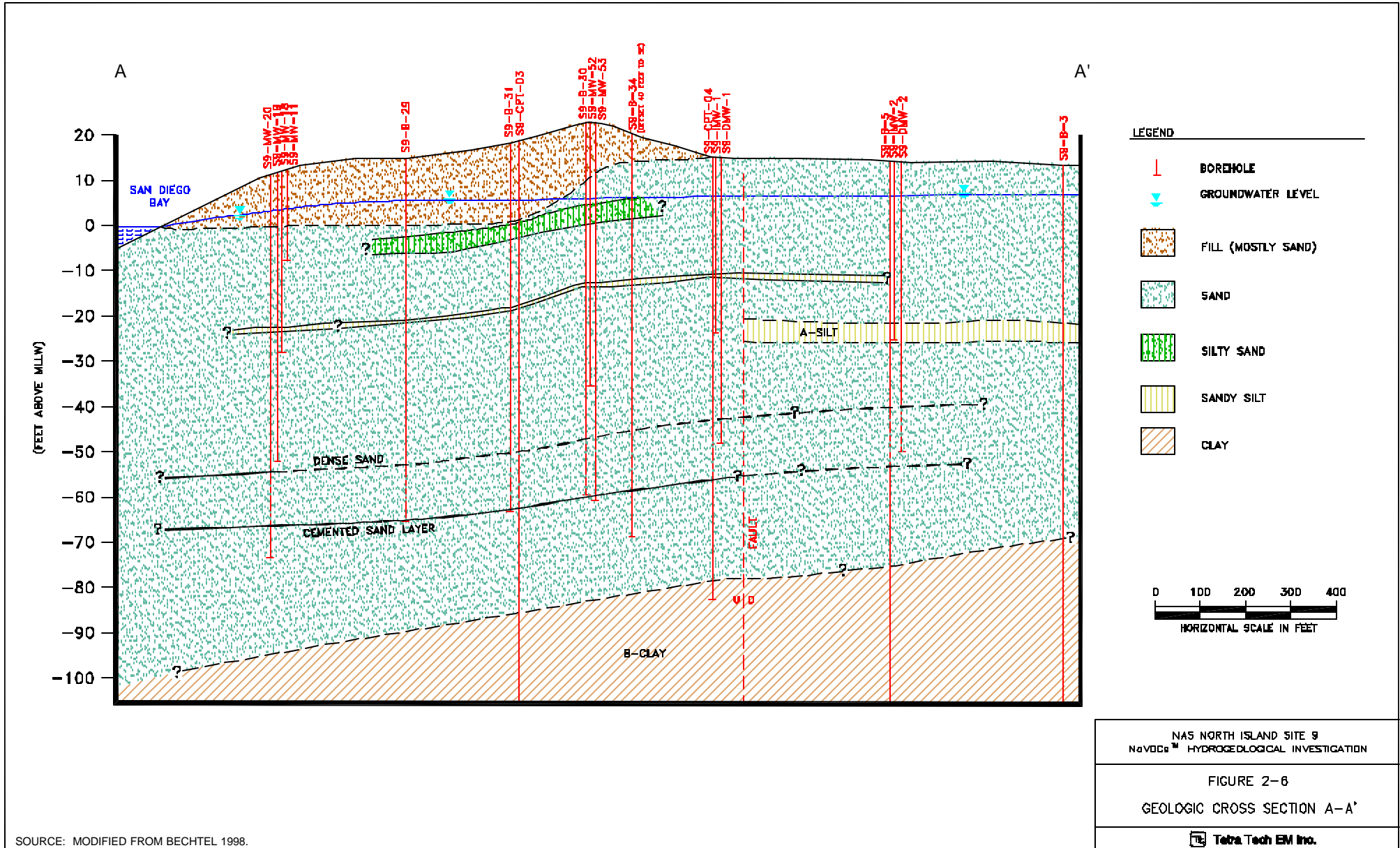

TABLE 2-1

**WELL SCREEN INTERVALS
NoVOCs HYDROGEOLOGICAL INVESTIGATION
NAS NORTH ISLAND**

Well	Description	Distance From NoVOCs Well (feet)	Screen Interval	
			Depth (feet bgs)	Elevation (feet relative to MLLW)
IW-01	NoVOCs well	0	43 to 47 and 72 to 78	-21.3 to -25.3 and -50.3 to -56.3
MW-45	Cross-gradient monitoring well	29.8	42 to 47	-20.0 to -25.0
MW-46	Cross-gradient monitoring well	27.7	57 to 62	-35.4 to -40.4
MW-47	Cross-gradient monitoring well	31.1	72 to 78	-49.9 to -55.9
MW-48	Cross-gradient monitoring well	61.9	52 to 57	-28.6 to -33.6
MW-49	Cross-gradient monitoring well	61.7	67 to 72	-43.6 to -48.6
MW-50	Cross-gradient monitoring well	90.7	52 to 57	-36.9 to -41.9
MW-51	Cross-gradient monitoring well	104.6	49 to 54	-35.1 to -40.1
MW-52	Downgradient monitoring well	93.0	41 to 46	-19.1 to -24.1
MW-53	Downgradient monitoring well	93.1	72 to 77	-50.4 to -55.4
MW-54	Upgradient monitoring well	107.9	38 to 78	-18.0 to -58.0

Notes:

bgs Below ground surface

MLLW Mean lower low water level

3.0 TIDAL INFLUENCE STUDY

This section describes the configuration for and procedures of the tidal influence study and presents its results. The NoVOCs™ system began operation during the tidal influence study. The effects of NoVOCs™ system operation on groundwater levels is also discussed.

3.1 CONFIGURATION AND PROCEDURES

Tetra Tech conducted a tidal influence study from April 20 through 30, 1998 to measure natural fluctuations in water level at the site caused by tidal influences. Water level changes in the aquifer caused by NoVOCs™ system operation were also recorded because the system was started and shut down multiple times during the study period. Tetra Tech installed pressure transducers in nine observation wells in the immediate vicinity of the NoVOCs™ system and measured changes in water levels in the observation wells before system startup and during system operation. Measurements were collected before startup of the NoVOCs™ system to measure natural fluctuations in water levels at the site caused by tidal influences and to establish baseline groundwater elevation conditions. Water levels were measured during system startup and operation to assess the magnitude and extent of the water level changes caused by the NoVOCs™ system. This information was used to assist in evaluating the extent of the NoVOCs™ treatment cell.

To document water level changes in the aquifer caused by the NoVOCs™ system, Aquistar pressure transducers were installed in observation wells MW-45 through MW-53 (Figure 2-2). Transducers were not installed in piezometers PZ-01 and PZ-02 because the inner diameters of the piezometers were smaller than the outer diameter of the transducers. The installation of a transducer in observation well MW-54 was precluded by the presence of a multilevel diffusion sampler inside the well.

The pressure transducers had a 3/4-inch outer diameter and were rated at 15 pounds per square inch (psi). All of the transducers are automatically compensated with barometric pressure changes (i.e., the pressure transducer readings are automatically adjusted to current atmosphere pressure). The transducers were installed approximately 6 feet below the water surface, and water level elevations were measured manually using an electronic water level sounder in each observation well immediately before the transducers were installed. Each transducer was connected to either a single- or multi-channel data logger. Before the transducers were installed, the data loggers were programmed to collect pressure readings every 10 minutes. The pressure readings are converted to feet of water above the transducer and

then to water level elevation. The transducers were used to collect groundwater elevation data from the observation wells from April 20 to 30, 1998. The transducers were removed from the observation wells on April 30, 1998. Water level readings were obtained with an electronic sounder before the transducers were removed to provide an additional accuracy check.

3.2 RESULTS

This section presents the results of the tidal influence study that was conducted to evaluate natural fluctuations in water levels at the site caused by tidal influences. The changes in water levels recorded in each of the observation wells were plotted versus time. These plots are presented in Appendix B. Figures B1 through B4 depict the fluctuations in water levels in the observation wells over the 10-day duration of the study. Figures B5 through B8 present the water levels in the observation wells for 12 hours of the first day of NoVOCs™ system operation. Figure B9 shows the water level fluctuation in San Diego Bay during the tidal study. The tidal influence and NoVOCs™ system influence are discussed separately in the following sections.

3.2.1 Tidal Influence

This section summarizes the effects of tidal influence on the groundwater levels. A detailed discussion of the analysis of the tidal influence study data is provided in Section 5.1.

Based on Figures B1 through B4, the water level readings follow a cyclical pattern in all observation wells included in the tidal study. Figures B1 through B4 illustrate the increase and decrease in groundwater levels caused by tidal fluctuations in San Diego Bay. Maximum groundwater level fluctuations measured in the observation wells ranged from 0.56 to 0.73 feet, depending on the location of the observation well. The amplitudes of the tidal fluctuations in water levels were highest for observation wells closest to San Diego Bay (MW-52 and MW-53). The other observation wells monitored during the tidal influence study (MW-45 through MW-51) are all located at approximately the same distance from San Diego Bay; the amplitudes of the tidal fluctuations in these wells are similar to one another.

The cyclical pattern of groundwater level fluctuation can be seen for all observation wells and correlates with published tide charts for San Diego Bay with a time lag ranging from approximately 46 to 96 minutes, depending on observation well location and magnitude of the tidal fluctuation. The time lag also depends on the degree of hydraulic communication between the bay and the wells. The range of time

lags is similar for each of the observation wells because of the similar distance relative to San Diego Bay. The aquifer zone is generally in good hydraulic communication with the San Diego Bay.

3.2.2 NoVOCs™ System Influence

Figures B5 through B8 show groundwater elevations during approximately 12 hours of the first day of the study that included several NoVOCs™ system startups and shutdowns. Table 3-1 lists the start and stop times for the NoVOCs™ system on April 20, 21, and 22, 1998, as reported by the Navy. Groundwater level changes caused by startup and shutdown of the NoVOCs™ system on April 20, 1998, are evident in the water level data for well cluster MW-45, MW-46, and MW-47, located approximately 30 feet from the NoVOCs™ well (Figure B5). The water level data for observation wells MW-45 (the upper screened well in this cluster) and MW-46 (intermediate screened well) show water level increases after system startup. The groundwater elevation increase in well MW-45 was approximately 0.15 foot of water. Observation well MW-46, the intermediate depth well, shows a water level increase of approximately 0.05 foot of water. Observation well MW-47, the deep screened well, shows a water level decrease of approximately 0.025 foot. This pattern of water level increases and decreases associated with the operation of the NoVOCs™ system is expected based on the monitoring well screen locations relative to the NoVOCs™ well screen locations. The deep screened well experiences a drop in water level as water is drawn toward the NoVOCs™ well intake, and the upper screened wells experience increases in water level as water is lifted inside the NoVOCs™ well, and discharges into the upper aquifer. In well pair MW-48 and MW-49 (located approximately 62 feet from the NoVOCs™ well) and in wells MW-50 and MW-51 (located approximately 91 and 105 feet, respectively, from the NoVOCs™ well), water level changes associated with NoVOCs™ system operation are not apparent (Figures B6, B7, and B8).

TABLE 3-1

**START AND STOP TIMES FOR THE NoVOCs SYSTEM
NoVOCs HYDROGEOLOGICAL INVESTIGATION
NAS NORTH ISLAND**

Date	Time^a	Action
April 20, 1998	10:01	Start
	10:01	Stop
	10:04	Start
	10:05	Stop
	10:18	Start
	10:24	Stop
	15:54	Start
	16:20	Stop
	18:08	Start
	18:32	Stop
	18:50	Start
	18:51	Stop
	18:56	Start
	19:00	Stop
	19:10	Start
April 21, 1998	16:20	Stop
	16:23	Start
	16:40	Stop
	18:45	Start
April 22, 1998	12:30	Stop
	13:03	Start
	13:12	Stop
	13:40	Start
	14:01 through 14:19	Six stop and start cycles to check auto shutdown functions
	14:19	Start (system in continuous operation)

Note:

a Rounded to nearest minute

4.0 AQUIFER TESTING

A series of aquifer tests were conducted at the demonstration site from July 27 through August 5, 1998, to obtain information on hydraulic communication between various portions of the aquifer beneath the site, as well as data for estimating values of aquifer hydraulic parameters such as hydraulic conductivity, transmissivity, storativity, and anisotropy. In addition, the aquifer tests were conducted to obtain data for calculating well efficiencies for the two screened intervals of the NoVOCs™ well.

Aquifer testing was conducted using the NoVOCs™ well (IW-01) as the pumping or injection well. Two piezometers and 10 observation wells were available for water level measurements. An inflatable packer was used to isolate the two screened intervals within the NoVOCs™ well to allow pumping from each screened interval separately. The aquifer tests, in the order conducted, were as follows:

- Step drawdown test in the upper screened interval conducted on July 27, 1998
- A 32-hour constant discharge pumping test in the upper screened interval conducted on July 28 and 29, 1998
- Injection test in the upper screened interval conducted on July 31, 1998
- Step drawdown test in the lower screened interval conducted on August 1, 1998
- Dipole flow test with pumping in the lower screened interval and injection in the upper screened interval conducted on August 5, 1998

A constant discharge pumping test for the lower screened interval was not conducted because of the excessive volume of water that would be generated and the prohibitive cost of water disposal.

4.1 PRETESTING ACTIVITIES

Before initiating the aquifer tests, certain downwell components of the NoVOCs™ system were removed, the well screens and filter pack were redeveloped, and aquifer testing equipment was installed. A description of each pretesting activity is provided in the following subsections.

4.1.1 NoVOCs™ Equipment Removal

To allow access for aquifer testing equipment, downwell components of the NoVOCs™ system were removed, except for the 8-inch diameter outer casing and the prepacked screen on the eductor casing at 72 to 78 feet bgs (-50.4 to -58.0 feet MLLW). In addition, piezometers, PZ-01 and PZ-02, set in the filter pack adjacent to the intake and recharge screens of the NoVOCs™ well, were not removed and were used as monitoring points during the aquifer tests. The downhole components removed included the 5-inch, schedule 40 polyvinyl chloride (PVC) eductor casing, the 2-inch PVC airline and diffuser, all packers, and downhole probes and meters.

4.1.2 Video Survey and Well Screen Development

To assess the condition of the NoVOCs™ well screens, a downhole video camera was lowered into the well to visually inspect the condition of the well casing and well screens. Two downwell video surveys of the NoVOCs™ well were conducted: one after internal NoVOCs™ well components were removed, and the other after well redevelopment and cleaning of the well screens. The camera was lowered on a taped cable so that the depth of the camera was known. The camera was capable of rotating up to 360 degrees on command. During the initial video survey, heavy orange iron staining on the well casing and well screens was observed. In addition, excessive orange iron flocculant was observed in the water column along with orange iron bioslime in the well screen intervals. Orange iron precipitant was also observed on the eductor pipe, eductor screen, and air line during removal of the internal well components. These observations suggest that iron precipitation and microbiological growth in the well are occurring. Both of these factors may impair the performance of the NoVOCs™ system by obstructing the well screen and filter pack material. Groundwater samples collected from the well by MACTEC confirmed that microorganisms were present in the NoVOCs™ well at high levels (Personal Communication from Scott Donovan, Bechtel 1998).

To remove the microbiological growth and precipitant, the well was redeveloped using surge and pump methods and hydrochloric acid was added to the well water. Approximately 2.5 gallons of hydrochloric acid were tremmied into the upper and lower screen intervals of the NoVOCs™ well, and the well water was agitated for a period 30 minutes. After cleaning the NoVOCs™ well screens with acid, the video camera was lowered into the well a second time to evaluate the effectiveness of well cleaning and development.

The second video survey showed that redevelopment and cleaning were effective in removing precipitant and microbiological growth in the well screens. In addition, the orange iron flocculant was removed from the water column within the well. Review of the integrity of the well casing during the second survey indicated that the well was intact with no signs of damage. However, a manufacturing defect in the upper well screen was observed. The screen slots in the upper well screen are unevenly cut, and about 30 percent of the slots do not completely penetrate the PVC casing. This defect limits the efficiency of the upper screen interval and may reduce the available water level rise in the NoVOCs™ well during recharge into the aquifer through the upper screen interval.

4.1.3 Aquifer Test Equipment Installation and Configuration

The first set of aquifer tests were conducted in the upper screened interval of the NoVOCs™ well and consisted of step drawdown, constant discharge, and injection tests. The second set of aquifer tests were conducted in the lower screened interval of the NoVOCs™ well and consisted of step drawdown and dipole flow tests. This section describes installation and configuration of aquifer testing equipment.

Pump and Packer

Pumping equipment configuration was identical for the step drawdown test and constant discharge pumping test conducted in the upper screened interval (Figures 4-1 and 4-2). To pump only the upper screened interval of the NoVOCs™ well, the two screened intervals were hydraulically separated using a 5-inch-diameter by 5-foot-long inflatable Baski packer. The inflatable packer was set between the two screened intervals at a depth of approximately 62 to 67 feet bgs (-40.3 to -45.3 feet MLLW). The pump used for the aquifer tests was a 4-inch stainless steel Grundfos submersible pump with a capacity of 100 gallons per minute. The pump was installed above the packer with its intake at approximately 55 feet bgs (-33.3 feet MLLW). The pump and the packer system were set in the NoVOCs™ well using a 2-inch diameter steel drop pipe (Figure 4-1). The drop pipe was secured at the well head and connected to a 2-inch diameter PVC discharge line. After the pump was set, the packer was inflated to a pressure of 70 pounds per square inch using a pressurized nitrogen cylinder. The packer's pressure was monitored throughout the pumping tests at the well head using a pressure gauge. The same equipment was used for the stepdrawdown and dipole flow tests conducted in the lower screened interval of the NoVOCs™ well (Figures 4-4 and 4-5). The packer was installed at approximately 56 to 61 feet bgs (-34.3 to -39.3 feet MLLW) and the submersible pump was set immediately below the packer at approximately 65 feet bgs (-43.3 feet MLLW).

Pressure Transducers and Data Loggers

Pressure transducers manufactured by Aquistar were installed in observation wells MW-45 through MW-54 and in the pumping well (one transducer above the packer system and one transducer below the packer). The pressure transducers used were pressure rated between 5 and 30 psi. The higher pressure rating transducers were installed in wells anticipated to exhibit the greatest change in water level (observation wells MW-45 through MW-49 and the pumping well). Transducers with pressure ratings of 5 psi were installed in observation wells farthest from the NoVOCs™ well (MW-50 through MW-54) because smaller changes in water levels were expected during the pumping tests.

The transducers were connected to single- and multi-channel data loggers. The pressure readings by the transducers were automatically adjusted to the atmosphere pressure so that no barometric pressure correction is needed for the pressure/water level readings by the transducers. In addition, barometric efficiency was expected to be low for the testing aquifer under unconfined condition. Therefore, barometric efficiency was not calculated and barometric pressure correction for observed water levels was not conducted.

During transducer installation, the depth to groundwater was measured with an electronic water level sounder before lowering the transducer into the well. The pressure transducer was then connected to the data logger and the transducer was lowered into the well. The transducer was set at a depth so that it would remain submerged during the pumping test at a depth below water not exceeding the pressure rating of the transducer. The pressure transducer cable was secured to the well head and the surface using duct tape, so that no movement occurred during the pumping test. After the transducer was secured, a reading of the length of the column of water above the transducer was recorded.

During the aquifer tests, the data loggers for the NoVOCs™ well and observation wells MW-45, MW-46, and MW-47 were constantly connected to a laptop computer to view recorded data. Data loggers for observation wells MW-48 through MW-54 were periodically connected to a laptop to confirm that water level readings were being recorded properly. In addition, transducer data were periodically checked by collecting water level measurements using an electronic water level sounder.

Other Equipment

During the aquifer tests, the pumping and injection rates were regulated using a variable rate controller, a flow control valve, and two inline flow meters. The flow meters used were a McCrometer electronic flow meter with totalizer and a Precision flow meter with totalizer. The meters were installed on the discharge pipe at the well head. The flow meters were calibrated in the field by measuring the time required to fill a 5-gallon bucket with water pumped through the discharge line.

All water generated during the pumping tests was piped to on-site storage tanks to await chemical characterization and subsequent disposal. To accommodate the volume of water generated during the pumping tests, four 20,000-gallon tanks were staged on site for storage of the extracted groundwater. Water quality parameters including pH, oxidation and reduction potential, specific conductance, temperature, and dissolved oxygen were measured during development and removal of the well water. Horiba U10 and YSI 2000 water quality meters were used to measure the water quality parameters in the field. The instruments were calibrated daily in accordance with the manufacturer's instructions.

4.1.4 Data Logger Programming

The data loggers were programmed using the length of the column of water above the transducer, depth of water below the top of well casing, and the survey elevation on the top of the casing so that subsequent readings were relative to MLLW. The data loggers were programmed for each pumping test to collect data at specific times and frequencies. Because of significant water level responses to changes in pumping rate (including starting and stopping pumping), the data loggers for the NoVOCs™ well and observation wells MW-45 through MW-47 were programmed to collect data at a higher frequency immediately following any change in pumping rate. The programmed data collection schedule was as follows: every half-second for 20 readings, every second for 50 readings, every 2 seconds for 60 readings, every 5 seconds for 60 readings, every 10 seconds for 30 readings, every minute for 20 readings, every 2 minutes for 20 readings, every 5 minutes for 12 readings, every 10 minutes for 18 readings, and every 20 minutes for 500 readings. (This schedule was reinitiated following any change in pumping rate and was generally terminated before the last step reached completion.) Collecting water level measurements in this manner provided data at higher frequencies when the rate of water level change was greater. Data loggers for observation wells MW-48 through MW-54 were programmed to collect data at lower frequencies, typically once per minute. All data were downloaded from the data logger to a computer and the data logger was reset between each aquifer test.

4.2 STEP DRAWDOWN TEST OF THE UPPER SCREENED INTERVAL

Tetra Tech conducted a step drawdown test in the upper screened interval of the NoVOCs™ well to estimate the optimal pumping rate for a constant discharge pumping test, and to estimate the well efficiency and specific capacity of the upper screened interval of the NoVOCs™ well. Test procedures and results are discussed below.

4.2.1 Procedures

On July 22, 1998, Tetra Tech conducted an initial step drawdown test on the upper screened interval of the NoVOCs™ well to estimate the optimal pumping rate for a constant discharge pumping test and the well efficiency and specific capacity of the upper screened interval of NoVOCs™ well. The step drawdown test was conducted by separating the upper and lower screened sections of the NoVOCs™ well using a packer system and pumping the upper screened interval of the well with a submersible pump (Figure 4-1), as described in Section 4.1.3. Based on observations of water levels in the recharge and intake piezometers (PZ-01 and PZ-02), the integrity of the inflatable packer seal between the upper and lower screens was determined to have been compromised during the initial test.

A second step drawdown test in the upper screened interval of the NoVOCs™ well was conducted on July 27, 1998. During the second test, water was first pumped at a rate of 43 gpm for about 17 minutes to check the integrity of the packer system. The water level in piezometers PZ-01 and PZ-02 remained stable during pumping of the upper screened interval, indicating that the packer seal was effective. Water was then pumped at 10 gpm for 11 minutes, 15 gpm for 45 minutes, and 20 gpm for 45 minutes. Water levels in the NoVOCs™ well and the surrounding observation wells were monitored using pressure transducers to measure changes in water level within the aquifer. A summary of the step drawdown test for the upper screen interval of the NoVOCs™ well is provided in Table 4-1.

4.2.2 Results

The pressure transducer and hand measurement data from the NoVOCs™ well (upper and lower intervals) and observation wells MW-45 through MW-54 are presented in Appendix C as Figures C1 through C7. Results for observation well MW-49 are not available because of a data logger malfunction.

Decreases in water levels were recorded in the pumping well (Figure C1) and observation wells MW-45 through MW-54 (Figures C2 through C7). The water level changes in the pumping well and observation wells exhibited similar patterns in response to changes in pumping rate; however, the responses decreased with distance from the NoVOCs™ well and with depth of the observation wells. When pumping at 20 gpm, the pumping well exhibited a maximum water level decrease of about 14 feet; observation well MW-45 (approximately 30 feet from the pumping well) showed a water level decrease of 0.6 foot; and observation well MW-51 (about 105 feet from the pumping well), showed a water level decrease of about 0.03 foot. The observation wells exhibited an almost immediate response to changes in pumping rate, suggesting that the aquifer has good communication in both the horizontal and vertical directions.

4.3 CONSTANT DISCHARGE PUMPING TEST OF THE UPPER SCREENED INTERVAL

A constant discharge pumping test in the upper screened interval was conducted following the step drawdown test in the upper screened interval of the NoVOCs™ well and following complete water level recovery in the pumping well, the observation piezometer, and the observation wells. Constant discharge pumping test procedures and results are discussed below.

4.3.1 Procedures

Based on the results of the step drawdown test (Section 4.2.2), 20 gpm was selected as the pumping rate for the constant discharge pumping test in the upper screening interval of the NoVOCs™ well. On July 28 through 30, 1998, Tetra Tech conducted a constant discharge pumping test to estimate the hydraulic conductivity, transmissivity, storativity, and anisotropy of the shallow aquifer. The constant discharge pumping test was conducted by isolating the upper and lower screened intervals of the NoVOCs™ well using a packer system and pumping the upper screened interval of the well with a submersible pump (Figure 4-2), as described in Section 4.1.3. Water was pumped at a constant discharge of 20 gpm for about 32 hours. Afterward, recovery data from the pumping well and the observation wells were collected for 24 hours. Recovery rates were recorded in the pumping well and all observation piezometers and wells. Pumping equipment remained in the pumping well until recovery monitoring was complete. Water levels in the NoVOCs™ well and the surrounding observation wells were monitored using pressure transducers to measure changes in water level within the aquifer. A summary of the constant discharge pumping test for the upper screened interval of the NoVOCs™ well is provided in Table 4-2.

4.3.2 Results

The pressure transducer and hand measurement data from the NoVOCs™ well and observation wells MW-45 through MW-54 are presented in Appendix D as Figures D1 through D6. Results for observation well MW-50 are not available because of a data logger malfunction.

Drawdown in the pumping well was measured at about 16 feet. With the exception of the pumping well, changes in water levels in the observation wells are difficult to discern without tidal corrections to determine actual drawdown. Tidal corrections for the constant discharge pumping test data are discussed and applied in Section 5.1.

4.4 INJECTION TEST OF THE UPPER SCREENED INTERVAL

The pumping equipment used for the step drawdown and constant discharge pumping tests were left in the well for the injection test in the upper screened interval. Injection test procedures and results are discussed below.

4.4.1 Procedures

The injection test was conducted in the NoVOCs™ well by injecting a constant rate of potable water through the upper screened interval of the NoVOCs™ well. Clean tap water was brought to the site using a fire hose and was stored adjacent to the NoVOCs™ well in a 300-gallon holding tank. Water was initially introduced to the NoVOCs™ well by gravity flow from the holding tank to the NoVOCs™ well. Water flow rates were controlled by a flow valve and were measured using an inline flow meter and totalizer. Flow rate was monitored closely so that a constant flow rate was injected. On July 30, 1998, approximately 1.5 hours after starting the injection test, water injection was terminated because particulate material was observed in the tap water being injected into the NoVOCs™ well. The particulate material was identified as scaling from the hose used to transport the potable water. Approximately 1,200 gallons of water had been injected during the initial injection test. To remove the particulate material injected, approximately 6,000 gallons of water was pumped from the upper screened interval of the NoVOCs™ well. To eliminate the particulate problem, the water storage tank was eliminated and a new fire hose was plumbed directly to the NoVOCs™ well through a flow control valve and inline flow meter (Figure 4-3). Before reinitiating water injection, the aquifer was allowed to stabilize overnight.

On July 31, 1998 through August 1, 1998, Tetra Tech conducted an injection test to obtain information on the recharge capacity and specific capacity of the upper screened interval of the NoVOCs™ well. Potable water was injected at rates of 5, 15, and 22 gpm for a period of about 1 hour at each rate. Potable water was also injected at a rate of 30 gpm for 4 minutes and 25 gpm for about 14 minutes. Based on the water injection rate and duration, a total of approximately 3,000 gallons of water was injected into the aquifer during the injection test. After water injection was stopped, water levels continued to be monitored for approximately 14 hours of recovery. A summary of the injection test for the upper screened interval of the NoVOCs™ well is provided in Table 4-3.

4.4.2 Results

The pressure transducer and hand measurement data from the NoVOCs™ well (upper and lower intervals), and observation wells MW-45 through MW-54 are presented in Appendix E as Figures E1 through E7. An increase in water level was recorded in the injection well and in observation wells MW-45 through MW-54. The water levels in the injection well and observation wells exhibited similar patterns in response to changes in pumping rate; however, the response decreased with distance from the NoVOCs™ well and with depth of the observation wells. The upper screened interval recharged clean tap water at a flow rate of 22 gpm for 1 hour with a 14.4 foot increase in water level. When the flow rate was increased to 30 gpm, the water level quickly increased another 3.6 feet to about 18 feet above the initial water level and began discharging at the ground surface. The injection rate was decreased to 25 gpm for about 15 minutes, during which groundwater elevations stabilized at about 17 feet above the initial water level. This information shows that the upper well screen can recharge clean tap water at an injection rate near the design pumping rate of the NoVOCs™ system (25 gpm). However, the injection rates were run for only 1 hour each and, therefore, the corresponding increase in water level may not represent complete stabilization of the aquifer.

4.5 STEP DRAWDOWN TEST OF THE LOWER SCREENED INTERVAL

After the injection test was completed and the aquifer had recovered, the pumping equipment was reconfigured for aquifer testing of the lower screened interval of the NoVOCs™ well (72 to 78 feet bgs). The procedures for and results of the step drawdown test of the lower screened interval are discussed below.

4.5.1 Procedures

On August 1 and 2, 1998, Tetra Tech conducted a step drawdown test to assess the well efficiency and specific capacity of the lower screened interval of the NoVOCs™ well. The step drawdown test was conducted by separating the upper and lower screened intervals of the NoVOCs™ well using a packer system and pumping the lower screened interval of the well with a submersible pump (Figure 4-4), as described in Section 4.1.3. Water was first pumped at a rate of 40 gpm for 10 minutes to check the integrity of the packer system. Water was then pumped at rates of 50, 64, and 30 gpm for a period of about 1 hour at each rate. After pumping stopped, water levels continued to be monitored for approximately 13 hours of recovery. A summary of the step drawdown test for the lower screened interval of the NoVOCs™ well is provided in Table 4-4.

4.5.2 Results

The pressure transducer and hand measurement data from the NoVOCs™ well (upper and lower intervals) and observation wells MW-45 through MW-54 are presented in Appendix F as Figures F1 through F7. Results for observation well MW-50 are not available because of data logger malfunction. A decrease in water level was recorded in the pumping well and observation wells MW45 through MW54. The water levels in the pumping well and observation wells exhibited similar patterns in responses to changes in pumping rate; however, the responses decreased with distance away from the NoVOCs™ well and with depth of the observation wells. A drawdown of greater than 20 feet was observed in the lower screened interval of the pumping well. The observation wells exhibited an almost immediate response to changes in pumping rate, suggesting that the aquifer has good communication in both the horizontal and vertical directions.

4.6 DIPOLE FLOW TEST

After the aquifer had recovered from the step drawdown test of the lower screened interval, the pumping discharge line was redirected to inject pumped water through the upper screened interval. The procedures for and results of the dipole flow test are discussed below.

4.6.1 Configuration and Procedures

On August 5 through 7, 1998, Tetra Tech conducted a dipole flow aquifer test (simultaneous pumping and injection of groundwater) to investigate groundwater circulation through the NoVOCs™ system and to calibrate the downhole inline flow meter. The dipole flow test was conducted by pumping a constant rate of groundwater from the lower screened section of the NoVOCs™ well and injecting groundwater into the upper screened section of the NoVOCs™ well (Figure 4-5). Groundwater was pumped and injected at rates of 5, 10, 15, 20, and 25 gpm for periods ranging from 54 to 71 minutes for each rate. Pumping and injection flow rates were measured using an inline flow meter. Flow measurement was also attempted using an orifice plate (the same orifice plate used in the NoVOCs™ well); however, the magnahelic used to measure pressure across the orifice plate was damaged during the test and reliable measurements could not be collected. Instead, pumping and injection flow rates were measured using an inline flow meter. A total of approximately 4,600 gallons of water were pumped and injected during the dipole flow test. A summary of the dipole flow test for the upper and lower screened sections of the NoVOCs™ well is provided in Table 4-5.

4.6.2 Results

Dipole flow test data are presented in Appendix G. Figure G-1 (Appendix G) shows pressure transducer data for the pumping and recharge intervals of the NoVOCs™ well. Hand measurements of water level rise at the upper recharge interval are also plotted. Drawdown data for the pumping interval show that the water level changed quickly and approached a steady state in a very short time. The drawdown recovery was just as rapid after the pump was turned off. This type of drawdown response makes analysis of transient state data difficult or impossible. In the other hand, water level rise data for the recharge interval show a longer transient stage at the beginning of each test step.

Pressure transducer and hand measurement data collected from the observation wells are presented in Figures G2 through G6 (Appendix G). As shown in Figure G2, well MW-45 shows a small water level rise during each step of the dipole flow test. In wells MW-46 and MW-47, some pressure response can be identified at the beginning of each step, but drawdown or water level rise cannot be positively measured at these two wells. Observation wells MW-48, MW-49, MW-51, MW52, MW53, and MW-54 showed very little or no response to the dipole flow test.

4.7 WATER QUALITY PARAMETERS

Water quality parameters including temperature, specific conductance, pH, reduction/oxidation potential, dissolved oxygen, salinity, and turbidity were measured in water from the pump discharge line during the pumping tests. A summary of the water quality parameter measurements is provided in Table 4-6. In general, results for the water quality parameters are higher in the lower screened zone, with the exception of pH and temperature. This finding is also supported by VOC concentration data from the wells at the demonstration site, which exhibit higher concentrations in samples from the deep wells than in samples from the shallow wells.

Specific conductance and salinity values measured during pumping of the upper screened interval averaged 22.2 micromhos per centimeter (Fmhos/cm) and 2.26 percent, respectively, while the same parameters measured during pumping of the lower screen interval averaged 27.4 Fmhos/cm and 2.71 percent. These results are consistent with the range of values and trend toward increased specific conductance and salinity with depth. Average temperature measured while pumping the upper and lower screened intervals was about 21.7 °C. Results of pH measurements while pumping the upper screened interval averaged 7.40, which was higher than the average pH value of 7.03 calculated from measurements collected when pumping the lower screened interval. The average reduction/oxidation potential in the upper interval was 22.7 millivolts (mv), while the average reduction/oxidation potential (Eh) in the lower interval was minus 30.5 mv. Dissolved oxygen concentrations also increased from an average of 7.92 milligrams per liter (mg/L) in the upper screened interval to 8.27 mg/L in the lower screened interval. Because the packer seal was not set appropriately during the July 22, 1998, step drawdown test in the upper screened interval, water quality measurements from the test were not used in calculating average water quality values.

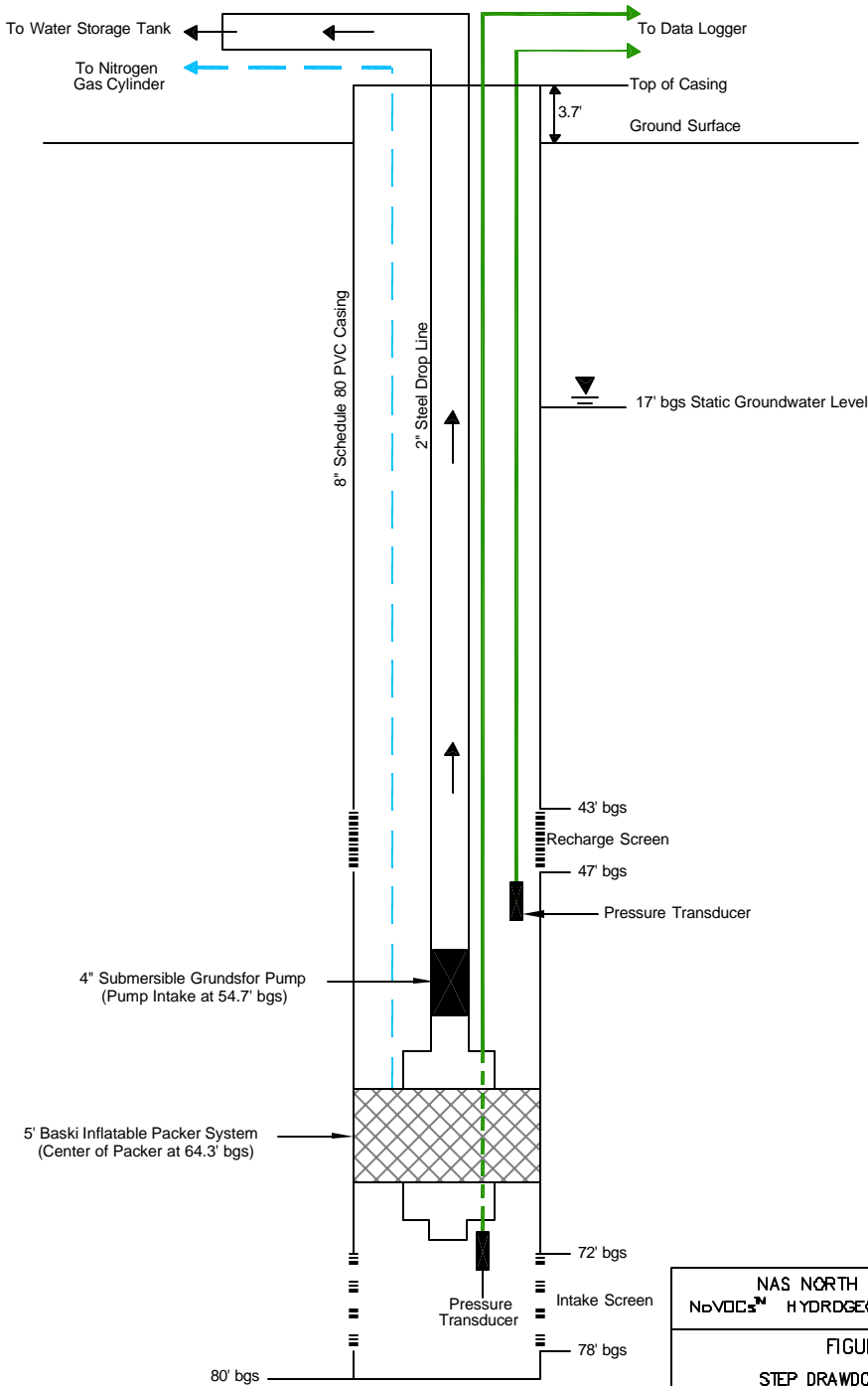

Vertical Scale: 1"=10'

NAS NORTH ISLAND SITE 9
 N_oVOCsTM HYDROGEOLOGICAL INVESTIGATION

FIGURE 4-1
 STEP DRAWDOWN TEST-UPPER
 SCREENED INTERVAL PUMPING WELL CONFIGURATION

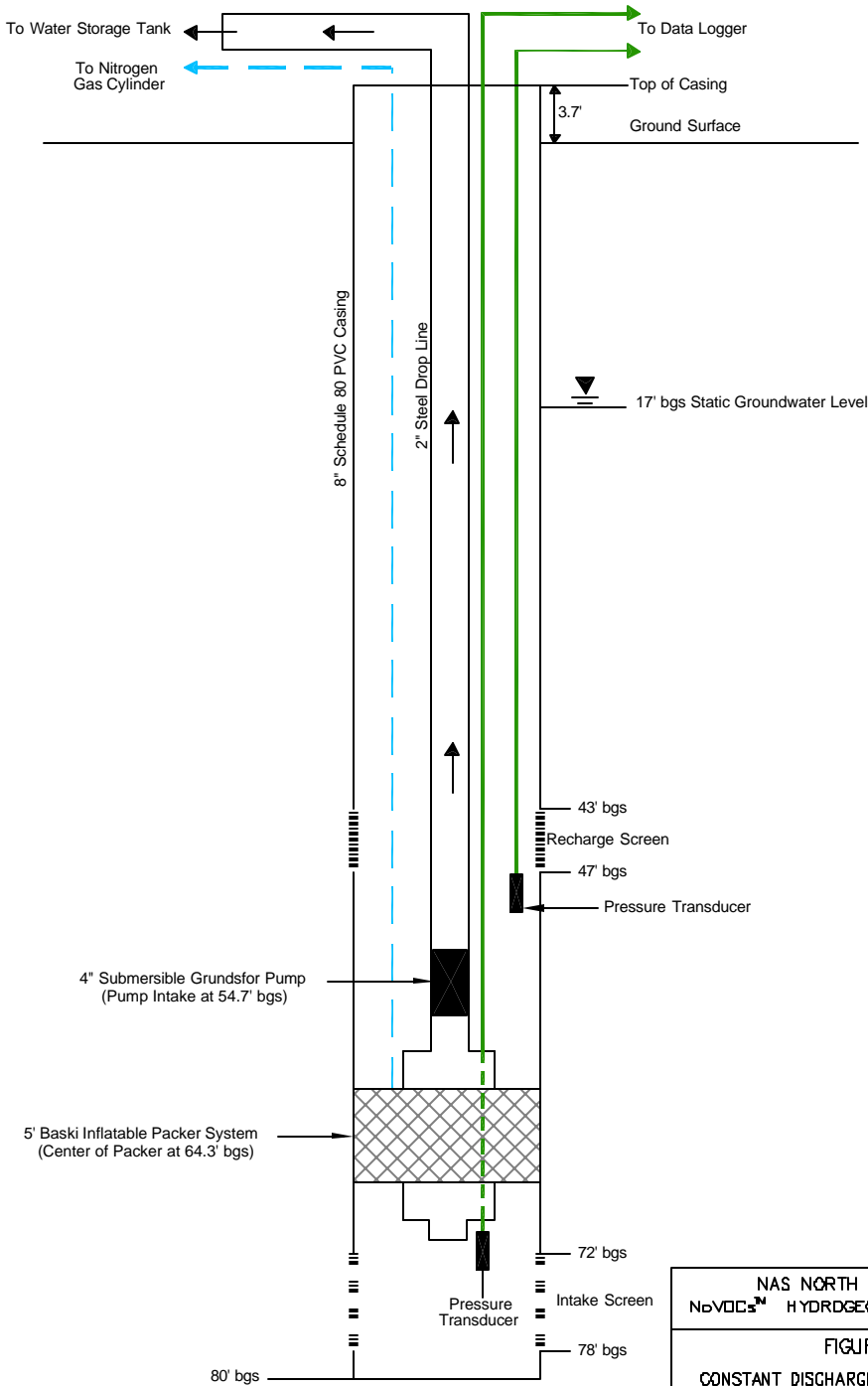

Vertical Scale: 1"=10'

NAS NORTH ISLAND SITE 9
 N_oVOCsTM HYDROGEOLOGICAL INVESTIGATION

FIGURE 4-2
 CONSTANT DISCHARGE PUMPING TEST-UPPER
 SCREENED INTERVAL PUMPING WELL CONFIGURATION

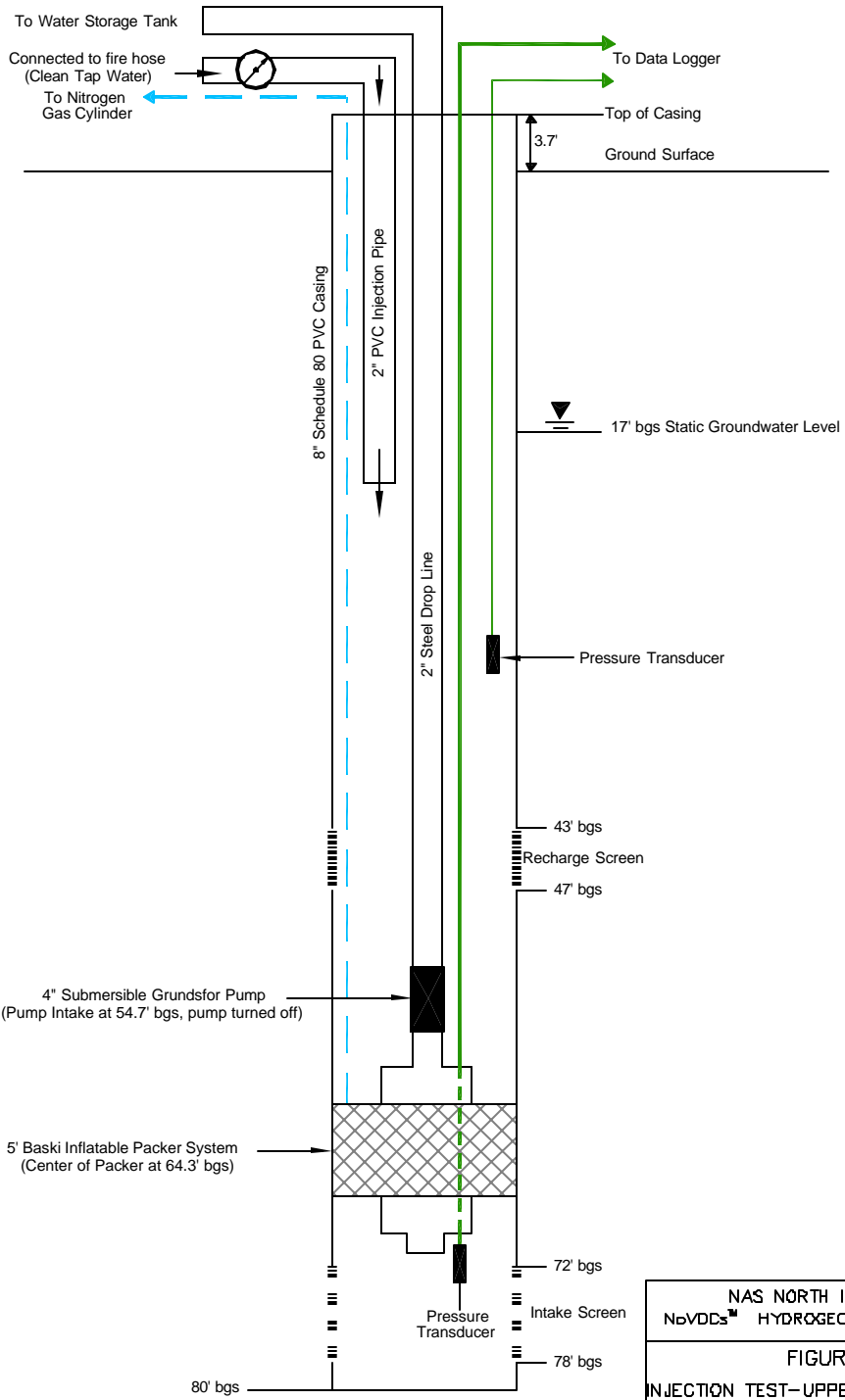

Vertical Scale: 1"=10'

NAS NORTH ISLAND SITE 9
 N6VDCs™ HYDROGEOLOGICAL INVESTIGATION

FIGURE 4-3
 INJECTION TEST-UPPER SCREENED INTERVAL
 INJECTION WELL CONFIGURATION

Tetra Tech EM Inc.

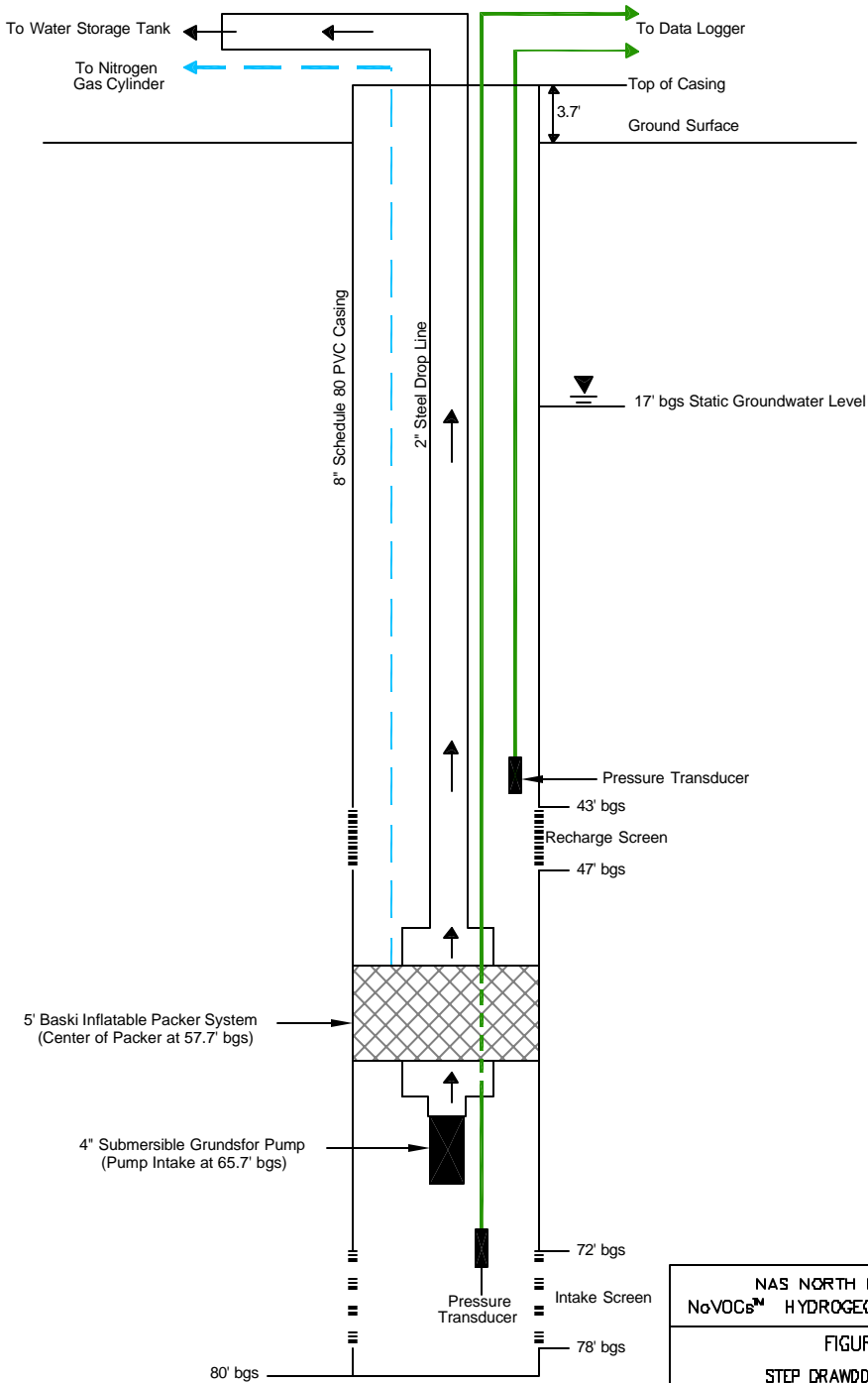

Vertical Scale: 1"=10'

NAS NORTH ISLAND SITE 9
 NgVOCsSM HYDROGEOLOGICAL INVESTIGATION

FIGURE 4-4
 STEP DRAWDOWN TEST-LOWER
 SCREENED INTERVAL PUMPING WELL CONFIGURATION

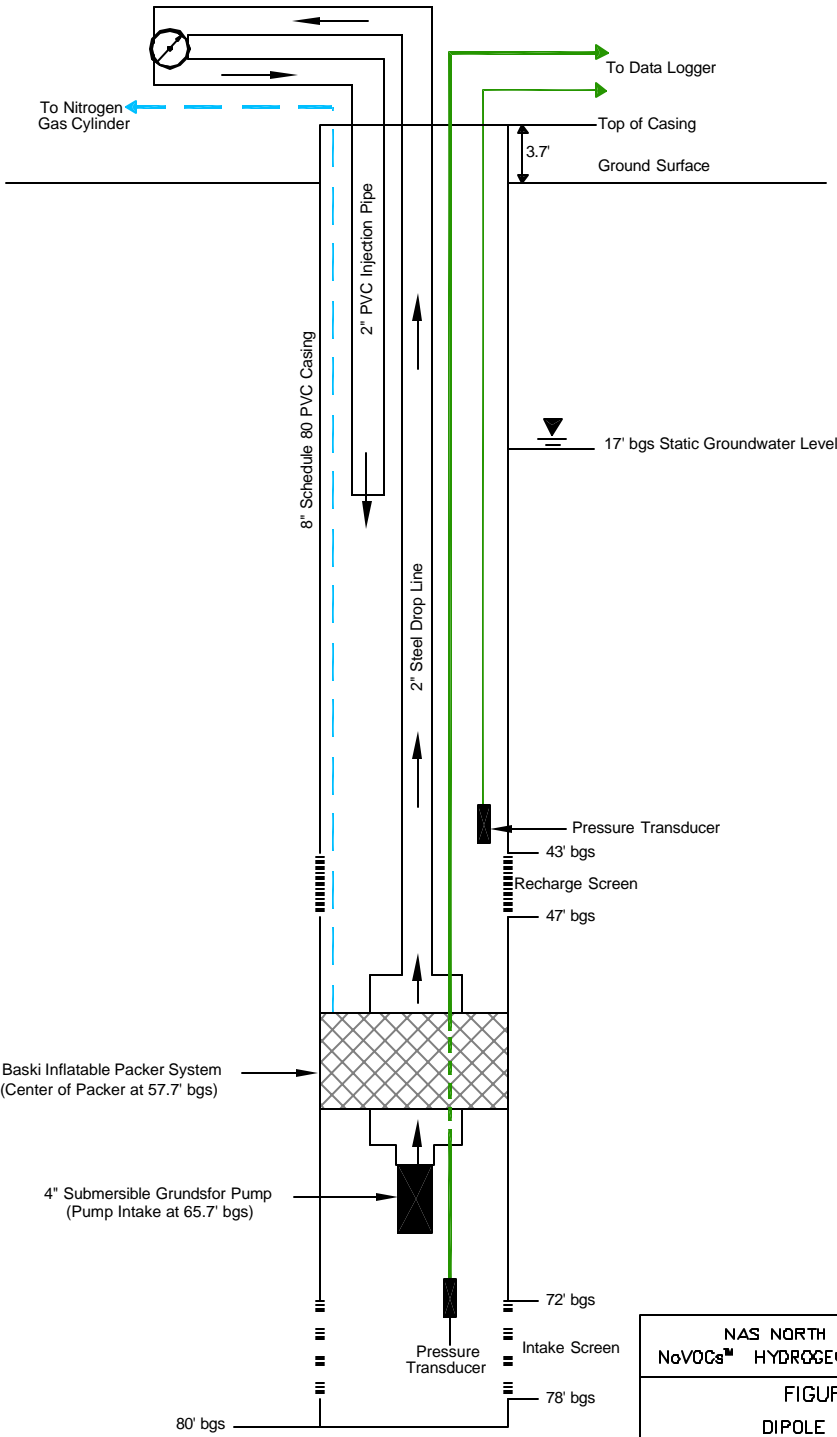

Vertical Scale: 1"=10'

<p>NAS NORTH ISLAND SITE 9 NgVOCs™ HYDROGEOLOGICAL INVESTIGATION</p>
<p>FIGURE 4-5 DIPOLE FLOW TEST WELL CONFIGURATION</p>
<p> Tetra Tech EM Inc.</p>

TABLE 4-1

**TEST EXECUTION SUMMARY
STEP DRAWDOWN TEST UPPER SCREEN INTERVAL
JULY 27, 1998
NoVOCs™HYDROGEOLOGICAL INVESTIGATION
NAS NORTH ISLAND**

Step	Pumping Rate	Time	Comments
0	NA	14:22	Static groundwater elevation at 17.35 feet below ground surface in the upper screened portion of the NoVOCs™well
1	43 gpm	14:30 to 14:47	Water level reached pump intake, a water level decrease of about 37 feet in the upper screened portion of the NoVOCs™well
Recovery	NA	14:47 to 16:00	Pump shut off; aquifer recovery monitored. Transducer lowered about 5 feet at 15:40.
2	10 gpm	16:00 to 16:11	Water level in well decreased 5.9 feet from initial level in upper screened portion of the NoVOCs™well
Recovery	NA	16:11 to 16:30	Pump shut off (circuit breaker problem); aquifer recovery monitored.
3	15 gpm	16:30 to 17:15	Water level decreased about 11.0 feet from initial level in the upper screened portion of the NoVOCs™well
4	20 gpm	17:15 to 18:00	Water level decreased about 14.2 feet from initial level in the upper screened portion of the NoVOCs™well
Recovery	NA	18:00 to 18:42	Pump shut off; aquifer recovery monitored

Notes:

NA Not applicable
gpm Gallons per minute

TABLE 4-2

**TEST EXECUTION SUMMARY
CONSTANT DISCHARGE PUMPING TEST UPPER SCREEN INTERVAL
JULY 28 THROUGH 30, 1998
NoVOCs™ HYDROGEOLOGICAL INVESTIGATION
NAS NORTH ISLAND**

Step	Pumping Rate	Time	Comments
0	NA	07:54 (7/28)	Initial groundwater elevation at 17.79 feet below ground surface in the upper screened portion of the NoVOCs™ well
1	20 gpm	08:00 (7/28) to 16:00 (7/29)	A total drawdown of 16.4 feet observed in the upper screened portion of the NoVOCs™ well
Recovery	NA	16:00 (7/29) to 14:00 (7/30)	Pump shut off; aquifer recovery monitored

Notes:

gpm Gallons per minute
NA Not applicable

TABLE 4-3

**TEST EXECUTION SUMMARY
INJECTION TEST UPPER SCREEN INTERVAL
JULY 31 AND AUGUST 1, 1998
NoVOCs™ HYDROGEOLOGICAL INVESTIGATION
NAS NORTH ISLAND**

Step	Injection Rate	Time	Comments
0	NA	14:55 (7/31)	Initial groundwater elevation at 17.47 feet below ground surface.
1	5 gpm	15:00 to 16:00	Water level in well increased 3.3 feet from initial level in upper screened portion of the NoVOCs™ well
2	15 gpm	16:00 to 17:00	Water level increased about 6.0 feet from Step 1 in the upper screened portion of the NoVOCs™ well
3	22 gpm	17:00 to 18:00	Water level increased about 5.1 feet from Step 2 in the upper screened portion of the NoVOCs™ well
4	30 gpm	18:00 to 18:04	Water level increased about 3.6 feet from Step 3 (water discharging at ground surface through piezometer)
5	25 gpm	18:04 to 18:18	Water level increased about 2.5 feet from Step 3 in the upper screened portion of the NoVOCs™ well
Recovery	NA	18:18 (7/31) to 08:15 (8/1)	Aquifer recovery data collected

Notes:

gpm Gallons per minute
NA Not applicable

TABLE 4-4

**TEST EXECUTION SUMMARY
STEP DRAWDOWN TEST LOWER SCREEN INTERVAL
AUGUST 1 AND 2, 1998
NoVOCs™HYDROGEOLOGICAL INVESTIGATION
NAS NORTH ISLAND**

Step	Pumping Rate	Time	Comments
0	NA	12:19 (8/1)	Initial groundwater elevation at 17.19 feet below ground surface in the upper screened portion of the NoVOCs™well
1a	40 gpm	12:30 to 12:40	Checking integrity of packer seal. Water decreased 11.4 feet from static in lower screened portion of the NoVOCs™well. Packer seal leaking.
Recovery	NA	12:40 to 13:00	Packer deflated and reinflated
1b	50 gpm	13:00 to 14:00	Recheck packer seal integrity. Packer seal integrity OK. Water level in well decreased 15.1 feet from initial level in lower screened portion of the NoVOCs™well
2	64 gpm	14:00 to 15:00	Water level decreased about 20.8 feet from initial level in the lower screened portion of the NoVOCs™well.
Recovery	NA	15:00 to 15:30	Pump shut off; aquifer recovery monitored
3	30 gpm	15:30 to 16:30	Water level decreased about 9.6 feet from initial level in the lower screened portion of the NoVOCs™well
Recovery	NA	16:30 (8/1) to 0730 (8/4)	Pump shut off; aquifer recovery monitored

Notes:

gpm Gallons per minute
NA Not applicable

TABLE 4-5

**TEST EXECUTION SUMMARY
DIPOLE FLOW TEST
AUGUST 5 THROUGH 7, 1998
NoVOCs™HYDROGEOLOGICAL INVESTIGATION
NAS NORTH ISLAND**

Step	Injection Rate	Time	Comments
0	NA	11:29 (8/5)	Initial groundwater elevation at 20.69 feet in upper section of the NoVOCs™well
1	5 to 6 gpm	11:35 to 12:29	Water level increased about 5.3 feet from initial water level in the upper screened section of the NoVOCs™well. Water level decreased about 2.2 feet from static water level in lower screened section of the NoVOCs™well.
2	10 gpm	12:29 to 13:40	Water level increased about 3.3 feet from Step 1 water level in the upper screened section of the NoVOCs™well. Water level decreased about 1.5 feet from Step 1 in the lower screened section of the NoVOCs™well.
3	15 gpm	13:40 to 14:41	Water level increased about 2.8 feet from Step 2 water level in the upper screened section of the NoVOCs™well. Water level decreased about 1.0 foot from Step 2 in the lower screened section of the NoVOCs™well.
4	20 gpm	14:41 to 15:47	Water level increased about 3.8 feet from Step 3 water level in the upper screened section of the NoVOCs™well. Water level decreased about 1.8 feet from Step 3 in the lower screened section of the NoVOCs™well.
5	24 to 25 gpm	15:47 to 16:41	Water level increased about 2.3 feet from Step 4 water level in the upper screened section of the NoVOCs™well. Water level decreased about 1.3 feet from Step 4 in the lower screened section of the NoVOCs™well.
Recovery	NA	16:41 (8/5) to 09:45 (8/7)	Aquifer recovery data collected

Notes:

gpm Gallons per minute
NA Not applicable

**WATER QUALITY PARAMETERS
AQUIFER PUMPING TESTS
NoVOCs™ HYDROGEOLOGICAL INVESTIGATION
NAS NORTH ISLAND**

Page 1 of 2

Date	Time	Temperature (°C)	Specific Conductance (µmhos)	pH	Eh (mv)	Dissolved Oxygen (mg/L)	Salinity (percent)	Turbidity (NTU)
Step Drawdown Test - Upper Screen Interval								
7/22/98	13:25	22	29.7	6.87	32	8.46	2.64	1
7/22/98	13:30	21.8	27.8	7.01	-40	8.48	2.67	53
7/22/98	13:35	22.0	27.3	7.08	-20	8.65	2.68	53
7/22/98	13:40	22.0	27.1	7.12	-29	8.63	2.59	53
7/22/98	--	21.5	27.9	7.17	-89	8.88	2.59	53
7/22/98	15:12	22.2	26.9	7.12	-11	8.72	2.67	1
7/22/98	15:24	21.3	26.9	7.09	-13	8.93	2.68	NM
Average		21.82	27.7	7.07	-24	8.68	2.65	36
Constant Rate Pump Test - Upper Screen Interval								
7/27/98	20:20	21.7	23.5	7.03	15	7.76	2.48	67
7/27/98	21:32	21.6	24.4	7.35	42	7.40	2.51	63
7/28/98	08:06	21.5	24.7	7.24	84	7.39	2.47	3
7/28/98	08:17	21.6	24.8	7.21	66	NM	NM	NM
7/28/98	10:23	22.5	24.7	7.33	59	8.44	2.44	60
7/28/98	11:20	22.0	24.5	7.37	30	8.64	2.43	55
7/28/98	12:23	22.0	24.6	7.39	31	8.64	2.43	61
7/28/98	14:26	22.1	23.9	7.39	67	8.54	2.38	54
7/28/98	15:30	21.8	23.6	7.42	18	8.64	2.38	3
7/28/98	16:36	22.5	23.3	7.41	41	9.62	2.34	3
7/28/98	17:33	21.8	23.2	7.43	37	8.54	2.31	50
7/28/98	19:57	21.6	22.8	7.44	31	7.58	2.25	3
7/28/98	21:14	21.5	22.5	7.45	-1	7.46	2.25	0
7/28/98	22:18	21.6	22.3	7.46	-9	7.43	2.22	0
7/28/98	23:09	21.4	22.2	7.47	-14	7.39	2.21	2
7/29/98	00:18	21.6	22.0	7.44	-15	7.33	2.19	0
7/29/98	01:15	21.6	21.7	7.43	-13	7.21	2.19	2
7/29/98	02:17	21.6	23.0	7.43	-7	7.30	2.18	4
7/29/98	03:15	21.6	23.2	7.43	-8	7.56	2.14	3
7/29/98	04:24	21.6	22.8	7.41	-7	7.62	2.13	2
7/29/98	05:19	21.6	23.0	7.44	-16	7.51	2.14	1
7/29/98	06:12	21.6	23.1	7.45	-9	7.56	2.16	5
7/29/98	07:00	21.3	18.7	7.47	-4	7.64	2.15	9
7/29/98	10:25	21.7	23.7	7.48	51	7.92	2.11	1
7/29/98	12:30	22.0	23.1	7.50	49	8.27	2.09	3
7/29/98	14:30	27.4	20.0	7.44	45	8.49	2.09	0
7/29/98	15:54	21.8	22.6	7.49	49	8.38	2.04	2
Average		21.95	23.03	7.40	22.67	7.93	2.26	17.54

TABLE 4-6

**WATER QUALITY PARAMETERS
AQUIFER PUMPING TESTS
NoVOCs™ HYDROGEOLOGICAL INVESTIGATION
NAS NORTH ISLAND
Page 2 of 2**

Date	Time	Temperature (°C)	Specific Conductance (μ mhos)	pH	Eh (mv)	Dissolved Oxygen (mg/L)	Salinity (percent)	Turbidity (NTU)
Step Drawdown Test - Lower Screen Interval								
8/1/98	13:34	21.8	24.2	6.97	-14	8.46	2.70	53
8/1/98	14:13	21.7	27.0	7.02	-31	8.37	2.70	2
8/1/98	14:30	21.7	27.0	7.11	-32	8.05	2.71	0
8/1/98	14:52	21.7	27.8	7.06	-32	8.35	2.72	62
8/1/98	15:46	21.9	29.0	7.02	-36	8.33	2.71	3
8/1/98	16:16	21.7	29.4	7.01	-38	8.06	2.72	6
Average		21.8	27.4	7.03	-31	8.27	2.71	21

Notes:

° C	Degrees Celsius.
μ mhos	Micromhos
mv	Millivolts
mg/L	Milligrams per liter
NTU	Nephelometric turbidity units
NM	Not measured
Eh	Reduction/oxidation potential

5.0 DATA INTERPRETATION

This section interprets and discusses the data collected during the aquifer tests and the tidal influence study, including groundwater tidal influence correction for the pumping test data, calculations of well-specific yield and efficiency, calculations of aquifer hydraulic parameters, calculations of the mean groundwater levels, calculations of fresh water equivalent heads (density correction) and estimation of groundwater flow patterns.

5.1 TIDAL INFLUENCE CORRECTION

Groundwater levels in the vicinity of the NoVOCs™ well are affected by tidal fluctuations in San Diego Bay because of hydraulic communication between the groundwater and the bay and the proximity of the site to the bay. Water level data derived from pumping tests must be corrected for tidal influence before they can be used to estimate aquifer parameters, except when the water level fluctuation caused by tides is insignificant in comparison with drawdown (such as in the pumping well). This section discusses the principles of and approaches to the tidal influence correction, and applies the corrections to the pumping test water level data.

5.1.1 Relationship Between Tide and Groundwater Fluctuation

Observed groundwater level fluctuations can be divided into two components: (1) tidally induced fluctuations, and (2) fluctuations caused by other factors. This relationship can be described by the following equation:

$$\frac{dh'(t)}{dt} = \frac{dh(t)}{dt} - E_{tide} \frac{dH(t-t_{lag})}{dt} \quad (5-1)$$

where

h_0	=	Groundwater elevations without tidal influence [L]
h	=	Observed groundwater elevation [L]
H	=	Tidal elevation in surface water body [L]
E_{tide}	=	Tidal efficiency [dimensionless]

t	=	The time when groundwater elevation was measured [T]
t _{lag}	=	Time lag between tidal effects in surface water body and corresponding effects at groundwater observation points [T]

The first term of the right-hand side of Equation 5-1 represents the observed groundwater level fluctuation, and the second term of the right-hand side represents tidally induced groundwater level fluctuation. The left-hand side of the equation represents groundwater fluctuations caused by other factors, such as pumping of groundwater, lateral changes in recharge or discharge in the aquifer, and other daily and seasonal water level changes (such as those caused by barometric pressure changes).

As shown in Equation 5-1, the relationship between the tidal fluctuation in the surface water levels and the tidally induced groundwater level fluctuation is determined by two parameters: tidal efficiency (E_{tide}), and time lag (t_{lag}). The tidal efficiency is defined as the ratio of tidally induced changes in groundwater levels to the tidal changes in the surface water body. The time lag represents the time difference between the tidal changes in the surface water body and corresponding changes in groundwater levels. Both the tidal efficiency and time lag are determined by a number of factors, including aquifer hydraulic conductivity and storativity (or diffusivity), aquifer thickness, and distance from the observation well to the surface water body. The relationship between the tidal influence parameters and the above factors in a homogeneous and isotropic aquifer can be expressed as follows (Jacob 1950; Ferris 1951):

$$E_{tide} = e^{\left(-x\sqrt{\frac{pS}{t_pKB}}\right)} \quad (5-2)$$

and

$$t_{lag} = x\sqrt{\frac{t_p S}{4pKB}} \quad (5-3)$$

where

x	=	Distance from the observation well to the coast line [L]
S	=	Aquifer storativity [dimensionless]
K	=	Aquifer hydraulic conductivity [LT^{-1}]
B	=	Aquifer thickness (L)
t _p	=	Tidal period (time between consecutive high and low tides) [T]

Based on Equations 5-2 and 5-3, the tidal efficiency will increase as aquifer hydraulic conductivity and aquifer thickness increase, and decrease as aquifer storativity and the distance from the coast increase. The tidal time lag will decrease as aquifer hydraulic conductivity and aquifer thickness increase, and increase as aquifer storativity and the distance from the coast increase. Based on these relationships, the time lag will generally decrease when tidal efficiency increases. Theoretically, the tidal efficiency and time lag are not functions of time.

Equations 5-2 and 5-3 are based on the following assumptions:

- Tidal fluctuations can be described as a sinusoidal function
- One-dimensional groundwater flow is perpendicular to the shoreline
- The aquifer is homogeneous and isotropic
- The aquifer is under confined conditions
- The shoreline is considered a lateral boundary that is perpendicular to groundwater flow direction
- The observation well fully penetrates the aquifer

In reality, aquifer conditions rarely meet all the above assumptions (Erskine 1991; Serfes 1991). Consequently, tidal efficiency and time lag are generally not calculated from Equations 5-2 and 5-3; the equations have been presented to provide a theoretical definition of tidal efficiency and time lag. Instead, these two parameters are usually determined directly from observed groundwater and surface water level fluctuations. A procedure to calculate tidal efficiency and time lag from the observed groundwater and tidal data is presented in the following section.

5.1.2 Procedure for Calculating Tidal Efficiency and Time Lag

In order to calculate the tidal efficiency and time lag from the observed surface water (San Diego Bay) and groundwater level data, an observation period should be selected during which the groundwater level fluctuations are primarily affected by tide; other factors affecting groundwater levels (such as rainfall infiltration and pumping) should be negligible. From Equation 5-1, if the effects of factors other than tidal fluctuations can be ignored ($dh' / dt = 0$), the observed groundwater fluctuations can be used directly to represent the tidally induced fluctuations, as expressed by the following equation:

$$\frac{dh(t)}{dt} = E_{tide} \frac{dH(t-t_{lag})}{dt} \quad (5-4)$$

For a time period from t_0 to t_1 in the groundwater observation record, the solution of Equation 5-4 can be obtained by integration as follows:

$$\int_{t_0}^{t_1} \frac{dh(t)}{dt} dt = \int_{t_0}^{t_1} E_{tide} \frac{dH(t-t_{lag})}{dt} dt \quad (5-5)$$

This integral can be expressed as follows:

$$h(t_1) - h(t_0) = E_{tide} [H(t_1 - t_{lag}) - H(t_0 - t_{lag})] \quad (5-6)$$

Based on Equation 5-6, the tidal efficiency can be calculated as follows:

$$E_{tide} = \frac{h(t_1) - h(t_0)}{H(t_1 - t_{lag}) - H(t_0 - t_{lag})} \quad (5-7)$$

Equation 5-7 represents the tidal efficiency for the period from t_0 to t_1 .

In principle, tidal efficiency and time lag are constants that do not vary with time. However, these parameters may vary from time to time because of groundwater flow conditions and inconsistencies in the amplitude and periodicity of tidal fluctuations. In general, various tidal efficiencies can be calculated using Equation 5-7 for different periods of the data. Different time lags can also be determined independently using different data sets. A procedure for calculation of tidal efficiency and time lag is described as follows:

- (1) Choose a period in the observed groundwater level record when groundwater fluctuations are almost exclusively caused by the tidal fluctuations.
- (2) Identify the high tide and low tide in tidal records, and identify corresponding groundwater high level and low level in groundwater level records.
- (3) Calculate tidal time lag as follows:

$$t_{lag} = t_{i(tide)} - t_{i(gw)} \quad (5-8)$$

where

- $t_{i(tide)}$ = Time for the i^{th} high (or low) tide [T]
 $t_{i(gw)}$ = Elevation time for the i^{th} high (or low) groundwater elevation corresponding to the i^{th} high (or low) tide [T]

(4) Calculate the tidal efficiency using the following equation:

$$E_{tide} = \frac{h_i - h_{i-1}}{H_i - H_{i-1}} \quad (5-9)$$

where

- H_i = The i^{th} high (or low) tidal elevation (L)
 h_i = The i^{th} high (or low) groundwater elevation corresponding to the i^{th} high (or low) tide [T]

Figure 5-1 presents a graphical illustration of the time lag and tidal efficiency (amplitudes of the tidal fluctuations in San Diego Bay and MW-45) based on a comparison of San Diego Bay water levels and groundwater levels in observation well MW-45.

5.1.3 Calculation of Tidal Efficiency and Time Lag Using April 1998 Tidal Study Data

Tidal efficiency and time lags were calculated based on the groundwater elevation data collected at eight observation wells during the April 1998 tidal influence study. The groundwater elevations in the wells were recorded at 10-minute intervals for 10 days. During this period, the surface water level data in San Diego Bay can be divided into 39 monotonic segments (that is, water levels from high to low or low to high tide). Groundwater levels at all observation wells clearly showed tidally influenced fluctuations that correspond to the tidal fluctuations in San Diego Bay. The average amplitude of tides in the bay for the 10-day period was 5.27 feet, and the average amplitude of groundwater fluctuations in various observation wells ranged from 0.36 to 0.46 feet. The maximum, minimum, and mean tidal amplitude and groundwater fluctuations are presented in Table 5-1.

The tidal efficiency and time lags were calculated for each of the 39 monotonic tidal segments during the 10-day tidal study using the procedure described in section 5.1.2. Table 5-1 shows the maximum, minimum, and mean estimated tidal efficiencies and time lags for the eight observation wells at the site.

As shown in the table, both the tidal efficiency and time lag vary slightly at the various observation well locations, but vary significantly during different tidal cycles, as indicated by the significant difference between minimum and maximum values of tidal efficiency and time lag. The mean tidal efficiency (average tidal efficiency for all 39 tidal periods) at the eight observation wells ranges from 0.07 to 0.09. The higher tidal efficiency values were measured at downgradient observation wells (MW-52 and MW-53), which are the closest to the bay of the wells monitored. The difference between the maximum and minimum tidal efficiency during different tidal cycles was about 0.03 for most of the wells.

The mean time lags (average time lag for all 39 monotonic tidal periods) did not change significantly from well to well, ranging from 69 minutes to 72 minutes. However, the time lags in each well changed considerably during different tidal cycles (Table 5-1).

5.1.4 Procedures for Tidal Correction of Groundwater Drawdown Data

When an aquifer hydraulic test is conducted in a tidally influenced aquifer, groundwater levels are affected by at least two major factors: drawdown from pumping and fluctuation caused by tide. Tidal fluctuation, if significant compared with pumping drawdown, can complicate interpretation of test data. Literature review shows that correction of non-steady state pumping test data for tidal influence has not been much studied and that no readily applicable methods are currently available. Therefore, in this section, two different approaches are developed and discussed. The two approaches? that is, the tidal correction of the drawdown data collected during the upper aquifer zone constant discharge pumping test? are presented in this section.

5.1.4.1 Approach Based on the Linear Relationship Between Groundwater and Tide

As shown in Equation 5-1, observed groundwater level fluctuations in tidally influenced aquifers are the sum of tidally induced fluctuations and water level changes caused by other factors. For the time period from t_0 to t , differential Equation 5-1 can be solved by integration, as follows:

$$\int_{t_0}^t \frac{dh'}{dt} dt = \int_{t_0}^t \frac{dh}{dt} dt - \int_{t_0}^t E_{tide} \frac{dH(t - t_{lag})}{dt} dt \quad (5-10)$$

This integral can be expressed as follows:

$$h'(t) = h(t) - h(t_0) - E_{\text{tide}} [H(t - t_{\text{lag}}) - H(t_0 - t_{\text{lag}})] + h'(t_0) \quad (5-11)$$

where

$h(t)$	=	Tidally corrected groundwater elevation at time t [L]
$h(t_0)$	=	Tidally corrected groundwater elevation at initial time t_0 [L]
$h(t)$	=	Observed groundwater elevation at time t [L]
$h(t_0)$	=	Observed groundwater elevation at initial time t_0 [L]
$H(t - t_{\text{lag}})$	=	Tidal elevation at time $t - t_{\text{lag}}$ [L]
$H(t_0 - t_{\text{lag}})$	=	Tidal elevation at time $t_0 - t_{\text{lag}}$ [L]
E_{tide}	=	Tidal efficiency [dimensionless]
t_{lag}	=	Time lag [T]

This equation shows that the groundwater elevations corrected for tidal influence can be calculated from the observed groundwater elevations, observed tidal elevations, and tidal influence parameters (tidal efficiency and time lag). The equation also shows that the tidal influence component of changes in groundwater level can be expressed as a linear function of tidal fluctuations in surface water.

Water level drawdowns at time t can be defined as:

$$s(t) = h_{\text{ref}} - h(t) \quad (5-12)$$

and

$$s'(t) = h_{\text{ref}} - h'(t) \quad (5-13)$$

where

h_{ref}	=	Reference groundwater level (a constant) [L]
$s(t)$	=	Observed water level drawdown at time t [L]
$s'(t)$	=	Tidally corrected water level drawdown at time t [L]

Using Equations 5-12 and 5-13 to substitute for $h(t)$, $h(t_0)$, $h'(t)$, and $h'(t_0)$ in Equation 5-11, the tidally corrected water level drawdown can be described as follows:

$$s'(t) = s(t) - s(t_0) - E_{tide} [H(t_0 - t_{lag}) - H(t - t_{lag})] + s'(t_0) \quad (5-14)$$

where

- $s(t_0)$ = Observed water level drawdown at initial time t_0 [L]
 $s'(t_0)$ = Tidally corrected water level drawdown at time t_0 [L]

Both Equations 5-11 and 5-14 assume that the tidal efficiency and time lag are constant over the calculation period from t_0 to t . However, as discussed in the previous section, tidal efficiency and time lag are generally not constant for different tidal periods (tidal cycles). In fact, tidal study data collected in April 1998 at the site demonstrate that tidal efficiency and time lag vary significantly over the 10-day period.

Equations 5-11 and 5-14 are the basis of the first approach (linear relationship) used for tidal correction of the groundwater drawdown data. The tide data were obtained from the San Diego Bay station of the National Oceanic and Atmospheric Administration (NOAA). The linear relationship approach for correcting groundwater drawdown data for tidal influence is described as follows:

- (1) Identify the high and low points in the bay tide elevation record, and divide the bay tide record into monotonic segments bounded by consecutive high and low tide elevations.
- (2) Identify the high and low groundwater levels in the groundwater drawdown data, and divide the groundwater drawdown data into segments that correspond to the monotonic tidal segments identified in step 1.
- (3) Compare each of the bay tidal segments with corresponding groundwater drawdown data segments to determine whether the time spans are similar for the two segments. If the time span for a monotonic tidal segment is different from the corresponding drawdown segment, the time scale of the tidal segment is compressed or expanded by linear interpolation to match the drawdown segment.
- (4) The first and last groundwater drawdown segments may or may not match a complete monotonic segment of the bay tide, depending on timing of the pumping test in relation to the tide cycles. Therefore, multiple smaller data segments are used to better match the time scale of the early pumping test data.
- (5) Shift the time axis of the bay tidal segments based on the range of the time lag values calculated from the April 1998 tidal study data (Table 5-1). Apply the tidal efficiency

(also Table 5-1) to correct each segment of observed groundwater drawdown using the equation:

$$s'(\mathbf{t}) = s(\mathbf{t}) - s(0) - E[H(0)_0 - H(\mathbf{t})] + s'(0) \quad (5-15)$$

where

$s(\tau)$	=	Corrected groundwater drawdown for the segment [L]
$s(0)$	=	Corrected groundwater drawdown at the start of the segment [L]
$s(\tau)$	=	Observed groundwater drawdown for the segment [L]
$s(0)$	=	Observed groundwater drawdown at the start of the segment [L]
$H(\tau)$	=	Tidal elevation for the segment [L]
$H(0)$	=	Tidal elevation at the start of the segment [L]
E	=	Tidal efficiency for the segment [dimensionless]
τ	=	Time since beginning of the segment [T]

- (6) The tidal correction procedure is repeated for all segments of the tidal and groundwater drawdown record.

5.1.4.2 Approach Based on the Best-Fit Equation of Groundwater Tidal Fluctuation

In the second approach for tidal correction of groundwater drawdown data, a tidal influence curve (best-fit equation) is generated for the period of the pumping test that reflects only tidal fluctuations. These tidal influence curves are generated for data from each of the observation wells. Using this approach, fluctuations in groundwater levels calculated from the tidal influence curve are subtracted from the observed drawdown data collected during the pumping test. The corrected drawdown can then be used to calculate aquifer parameters.

The tidal influence curves for observation wells within the radius of influence during a pumping test can be derived from the tidal influence curves for data from wells outside the radius of influence or from tidal curves for the bay tide. Tidal data collected at the observation wells before or after the pumping test cannot be used because the bay tide changes significantly with time. During the pumping test, tidal fluctuation at different wells within the pumping aquifer is generally a function of aquifer hydraulic properties and distance from the shoreline but not a function of time, as described in Equations 5-2 and 5-3.

In general, the tidal influence curve at a monitoring well is described as a series of sinusoidal (or cosine) functions as follows:

$$f(t) = A + \sum_{i=1}^n B_i \sin\left[\frac{2\pi}{T_i}(t + \tau_i)\right] \quad (5-16)$$

where

- A = A constant related to the difference between groundwater and bay tide elevations [L]
- B_i = The amplitude of the *i*th tidal constituent [L]
- T_i = The period of the *i*th tidal constituent [T]
- τ_i = The phase of the *i*th tidal constituent [T]

The amplitude, period, and phase of the tidal function in groundwater are related to the tidal efficiency and time lag of the aquifer and the same parameters of the bay tidal constituents. The bay tidal constituents in turn are caused by the rotation of the Earth about the sun, the moon about the Earth, and the Earth on its axis. The amplitude, period, and phase of each tidal constituents (waves) of the tidal influence function can be calculated through harmonic analysis, which is commonly used to predict ocean tides at various locations in the United States. The phase of the ocean tide is determined by the starting point of the prediction, and the phase of groundwater tidal influence is a function of the starting point of the calculation and time lag behind the ocean tide.

Groundwater level at well MW-20 was observed using a pressure transducer during the entire period of the aquifer test (including step drawdown and constant discharge pumping tests). Well MW-20 is located approximately 800 feet from the NoVOCs™ pumping well and about 140 feet from San Diego Bay. This well is clearly outside the radius of pumping influence. Therefore, the second approach (best-fit equation) was developed using groundwater level data for well MW-20.

The tidal correction procedures for the pumping test drawdown data based on the best-fit equation approach is described as follows:

- (1) Plot the groundwater level data collected from well MW-20. Based on Equation 5-16, a best-fit tidal curve (as a sinusoidal equation) can be obtained through harmonic analysis. The plot and best-fit tidal curve are presented in Figure 5-2. The correlation coefficient

(R^2) of the best-fit equation (tidal curve) is 0.96. The tidal curve for MW-20 is described as:

$$f_{MW-20}(t) = 3.60 + 0.21 \sin\left(\frac{2p}{25.76}t\right) + 0.51 \sin\left[\frac{2p}{23.78}(t - 1.72)\right] \\ + 0.69 \sin\left[\frac{2p}{12.36}(t - 6.87)\right] + 0.29 \sin\left[\frac{2p}{11.89}(t - 8.92)\right] \quad (5-17)$$

- (2) Select a time period when the pumping impact is insignificant (from August 1 through 4, 1998, after the deep aquifer zone step drawdown tests), and compare data for well MW-20 with the bay tide and groundwater level data collected from other observation wells (Figures 5-3 through 5-10)
- (3) Based on Equation 5-17 and Figure 5-3, generate the tidal influence curve for well MW-45: the elevation constant (A) is calculated
- (4) Based on the difference between the average groundwater elevations in wells MW-20 and MW-45; the amplitude constants (B_i) are calculated based on the difference in tidal efficiency between the two wells; the tidal period constants (T_i) are kept the same; and phase constants (τ_i) are adjusted based on the starting time and the different time lags between the two wells. The tidal influence curve for well MW-45 during the period of the constant discharge pumping test is described as follows:

$$f_{MW-45}(t) = 5.00 + 0.057 \sin\left[\frac{2p}{25.76}(t + 0.79)\right] + 0.12 \sin\left[\frac{2p}{23.78}(t - 0.05)\right] \\ + 0.29 \sin\left[\frac{2p}{12.36}(t - 7.94)\right] + 0.15 \sin\left[\frac{2p}{11.89}(t - 8.11)\right] \quad (5-18)$$

- (5) Repeat Steps 3 and 4 to obtain the tidal influence curves for data from wells MW-46, MW-47, MW-48, MW-49, MW-52, MW-53, and MW-54. Equation 5-17 and Figures 5-3 through 5-10 are used for determining the tidal influence functions. The tidal influence curves for these wells during the constant discharge pumping test are described by the following equations:

$$f_{MW-46}(t) = 4.77 + 0.05 \sin\left[\frac{2p}{25.76}(t + 0.31)\right] + 0.14 \sin\left[\frac{2p}{23.78}(t - 1.42)\right] \\ + 0.26 \sin\left[\frac{2p}{12.36}(t - 8.13)\right] + 0.16 \sin\left[\frac{2p}{11.89}(t - 8.32)\right] \quad (5-19)$$

$$\begin{aligned}
 f_{MW-47}(t) = & 4.51 + 0.06 \sin\left[\frac{2p}{25.76}(t + 2.95)\right] + 0.142 \sin\left[\frac{2p}{23.78}(t + 0.63)\right] \\
 & + 0.283 \sin\left[\frac{2p}{12.36}(t - 7.78)\right] + 0.163 \sin\left[\frac{2p}{11.89}(t - 7.66)\right]
 \end{aligned} \tag{5-20}$$

$$\begin{aligned}
 f_{MW-48}(t) = & 4.71 + 0.12 \sin\left[\frac{2p}{25.76}(t + 1.63)\right] + 0.163 \sin\left[\frac{2p}{23.78}(t + 0.55)\right] \\
 & + 0.26 \sin\left[\frac{2p}{12.36}(t - 8.60)\right] + 0.19 \sin\left[\frac{2p}{11.89}(t - 9.15)\right]
 \end{aligned} \tag{5-21}$$

$$\begin{aligned}
 f_{MW-49}(t) = & 4.51 + 0.02 \sin\left[\frac{2p}{25.76}(t + 0.30)\right] + 0.06 \sin\left[\frac{2p}{23.78}(t - 0.78)\right] \\
 & + 0.266 \sin\left[\frac{2p}{12.36}(t - 8.09)\right] + 0.167 \sin\left[\frac{2p}{11.89}(t - 8.38)\right]
 \end{aligned} \tag{5-22}$$

$$\begin{aligned}
 f_{MW-52}(t) = & 4.76 + 0.02 \sin\left[\frac{2p}{25.76}(t + 1.86)\right] + 0.08 \sin\left[\frac{2p}{23.78}(t - 0.31)\right] \\
 & + 0.205 \sin\left[\frac{2p}{12.36}(t - 7.91)\right] + 0.08 \sin\left[\frac{2p}{11.89}(t - 9.14)\right]
 \end{aligned} \tag{5-23}$$

$$\begin{aligned}
 f_{MW-53}(t) = & 4.49 + 0.02 \sin\left[\frac{2p}{25.76}(t + 1.86)\right] + 0.14 \sin\left[\frac{2p}{23.78}(t - 1.42)\right] \\
 & + 0.26 \sin\left[\frac{2p}{12.36}(t - 8.13)\right] + 0.16 \sin\left[\frac{2p}{11.89}(t - 8.32)\right]
 \end{aligned} \tag{5-24}$$

$$\begin{aligned}
 f_{MW-54}(t) = & 5.04 + 0.035 \sin\left[\frac{2p}{25.76}(t + 0.31)\right] + 0.103 \sin\left[\frac{2p}{23.78}(t - 1.08)\right] \\
 & + 0.275 \sin\left[\frac{2p}{12.36}(t - 8.13)\right] + 0.16 \sin\left[\frac{2p}{11.89}(t - 8.32)\right]
 \end{aligned} \tag{5-25}$$

- (6) Calculate tidal fluctuation in groundwater using the above tidal influence equations for data from all observation wells. Subtract the tidal fluctuation from the observed groundwater elevations, and calculate tidally corrected drawdown from the tidally corrected groundwater elevations. Using data for well MW-45 as example, the corrected drawdown is calculated using the following equation:

$$s^*(t) = [h(0) - f_{MW-45}(0)] - [h(t) - f_{MW-45}(t)] \quad (5-26)$$

where

$s^*(t)$	=	Tidally corrected groundwater drawdown [L]
$h(0)$	=	Observed groundwater elevation at the beginning of the pumping test [L]
$h(t)$	=	Observed groundwater elevation during the pumping test [L]
$f_{MW-45}(0)$	=	Calculated groundwater elevation from the tidal influence curve at the beginning of the pumping test [L]
$f_{MW-45}(t)$	=	Calculated groundwater elevation from the tidal influence curve at the beginning of the pumping test [L]

5.1.5 Tidal Influence Correction for the Constant Pumping Test

As shown in Figures D2 through D6 in Appendix D, groundwater level data collected during the constant discharge pumping test in the upper aquifer zone showed significant tidal influence. In order to use the pumping test data to calculate aquifer hydraulic parameters, the observed groundwater drawdown must be corrected for tidal influence. The goal of the tidal influence correction is to separate groundwater drawdown caused by pumping from groundwater fluctuations caused by tidal influence, only the pumping-induced groundwater drawdown is used to calculate aquifer parameters.

Two tidal influence correction approaches are developed and discussed in Section 5.1.4. Both approaches are used to correct the drawdown data collected during the constant discharge pumping test in the upper aquifer zone. The two key tidal influence parameters, tidal efficiency and time lag, are applied in the first approach to derive fluctuations in groundwater caused by tides at the observation wells. The parameter values are initially calculated from the April 1998 tidal study data. Because the bay tide during the pumping test (July/August 1998) was different from the tide in April 1998, the parameters are adjusted to provide the best results of tidal influence correction. Table 5-2 shows the adjusted tidal efficiency and time lags used for the tidal influence correction.

Observed San Diego Bay tide and groundwater levels in well MW-20, the simulated tidal influence (curves), and observed groundwater levels for well MW-45 during the constant discharge pumping test are compared in Figure 5-11. The figure shows that the tidal influence decreased with distance from the bay, and that the simulated tidal influences using the two different approaches are similar.

Figures 5-12 through 5-19 compare the observed and corrected groundwater drawdown data at different observation wells for the constant discharge pumping test. As shown in these figures, the original observed groundwater drawdown graphs indicate significant tidal influence. After correction for tidal influence, the groundwater drawdown curves show typical groundwater level drawdown caused by pumping. The figures also show that the tidal influence corrections using the two different approaches are generally in close agreement. The corrected groundwater drawdown data using the linear relationship approach are applied in Section 5.3 to calculate aquifer parameters.

In summary, two new approaches for tidal correction of groundwater drawdown data collected during a pumping test have been developed. The corrected drawdown data using both approaches correlated reasonably well with each other and reflect typical pumping test responses. Some uncertainties associated with both tidal correction approaches include impact of aquifer heterogeneity, differences in tidal fluctuation during different tidal periods (tidal cycles), and interpolation of tidal data to match frequent data records at the early stage of the pumping test.

5.2 CALCULATION OF SPECIFIC CAPACITY AND WELL EFFICIENCY

This section presents the calculations of specific capacity and well efficiency for the NoVOCs™ well. The calculations are based on water level data collected from the step-drawdown test conducted in the upper screened portion of the well (screened in the upper aquifer zone), the step-drawdown conducted in the lower screened portion (screened in the deep aquifer zone), and the water injection test conducted in the upper screened portion.

5.2.1 Specific Capacity Calculation

Specific capacity of a pumping well is calculated based on (1) the pumping rate and measured maximum drawdown for pumping tests, or (2) the injection rate and maximum water level rise for injection tests (assuming the drawdown and water level rise had stabilized) during each test step. The upper aquifer zone step-drawdown test was conducted in three steps. The upper aquifer zone step-injection test and the deep aquifer zone step-drawdown pumping test were each conducted in four steps. The specific capacity is calculated using the following equation:

$$q_i = \frac{Q_i}{s_i} \quad (5-27)$$

where

q_i	=	Specific capacity [L^2T^{-1}]
Q_i	=	Pumping (or injection) rate [L^3T^{-1}]
s_i	=	Maximum drawdown (or water level rise) [L]

Figures C1, E1, and F1 (Appendices C, E, and F) show the water levels during the step tests. Table 5-3 shows the step test data and calculated specific capacities for each step of the tests. Based on the upper aquifer step-drawdown test, specific capacity of the NoVOCs™ well calculated for various steps ranges from 1.35 to 1.70 gpm/ft, with the average of 1.48 gpm/ft. The upper aquifer injection test shows similar results, and the calculated specific capacity ranges from 1.45 to 1.57 gpm/ft, with the average of 1.50 gpm/ft. The specific capacity values estimated from the deep aquifer step-drawdown test are higher than for the upper aquifer zone. The calculated specific capacity for the deep aquifer ranges from 3.02 to 3.51 gpm/ft, and the average specific capacity is 3.22 gpm.

5.2.2 Well Loss and Well Efficiency

The theory and concept of well loss and well efficiency and applied approaches for step-drawdown test data analysis have been extensively discussed in the literature. Currently, there are still different theories and approaches to calculate well efficiency. This section presents a brief evaluation of different approaches (Section 5.2.2.1) and calculation of well loss and well efficiency for the NoVOCs™ well based on the step-drawdown and step-injection test data (Section 5.2.2.2).

5.2.2.1 Evaluation of Different Approaches

The discussion of well loss and well efficiency are somewhat conflicting and confusing, as reflected in the literature (Jacob 1947; Rorabaugh 1953; Driscoll 1986; and Kawecki 1995). According to Jacob (1947), total drawdown in a pumping well can be divided into two components: (1) aquifer drawdown that can be described as a linear (first order) function of pumping rate and (2) well loss (caused by turbulent flow) that can be described as an second-order function of the pumping rate, as follows:

$$s = BQ + CQ^2 \quad (5-28)$$

where

s	=	Total drawdown (or water level rise) in the pumping (injection) well [L]
Q	=	Pumping rate [L^3T^{-1}]
B	=	Aquifer drawdown coefficient [$L^{-2}T$]
C	=	Well loss coefficient [$L^{-5}T^2$]

Rorabaugh (1953) proposed a more general empirical form of well loss that is described as a n^{th} -order function of the pumping (or injection) rate. Thus, the total drawdown can be expressed as follows:

$$s = BQ + CQ^n \quad (5-29)$$

Step-drawdown tests are commonly used to determine B, C, and n. Rorabaugh (1953) used n values ranging from 2.43 to 2.82; however, Lennox (1966) reported that $n=3.5$ was more suitable for his step-drawdown test data analysis. In practice, Equation 5-28 has been more widely used and the well loss component is generally considered a second-order function of the pumping rate ($n=2$). BQ represents aquifer drawdown caused by pumping, and CQ^2 represents the well loss. Once the coefficients B and C are determined, the well efficiency E_{well} (in percent) is calculated as follows:

$$E_{\text{well}} = \frac{s - CQ^2}{s} \times 100 \quad (5-30)$$

Driscoll (1986) pointed out that Jacob's and Rorabaugh's definitions of well loss and well efficiency were inadequate and that their assumptions that well loss is attributable to turbulent flow and aquifer drawdown is attributable to laminar flow were incorrect. Based on Driscoll (1986), a portion of the CQ^2 term might actually come from aquifer drawdown and portion of BQ term might include well losses. Driscoll's conclusion was reportedly based on testing of hundreds of wells, however, no details were given regarding the tests and data.

Kawecki (1995) concluded that traditional methods of analyzing step-drawdown test data produce information (well loss and well efficiency) that can be misleading, inaccurate, or meaningless. Kawecki's conclusion is based on the assumption that well losses include both linear and nonlinear components.

Kawecki separated the aquifer drawdown coefficient (B) into B_1 and B_2 ; where B_1 represents the “true aquifer drawdown” coefficient as a function of “real well radius” and time, and B_2 represents the linear well loss coefficient.

Calculating the well efficiency based on the “true aquifer drawdown” and “real well radius” is not a simple task because the “true aquifer drawdown” cannot be readily measured in most cases. Calculated aquifer drawdown is generally not accurate because of uncertainties associated with the parameters and model assumptions. The methods provided by Driscoll (1986, page 558) and Kawecki (1995) both require accurate values for aquifer and pumping well parameters. Driscoll’s and Kawecki’s examples show that the calculated well efficiencies based on the aquifer and pumping well parameters can have a large range of values because of uncertainties of the estimated parameter values. Therefore, the methods by Driscoll and Kawecki are inaccurate and impractical.

Dawson and Istok (1991) proposed two methods to determine the well efficiency. The first method is similar to the Driscoll (1986) method that requires calculation of the theoretical aquifer drawdown based known aquifer transmissivity and storativity values. The second method plots distance-drawdown data from at least three observation wells and extrapolates a straight fitted line to project aquifer drawdown at the pumping well. There are two problems with this method: (1) aquifer drawdown is not a linear function of distance, nor a logarithmic linear function of distance because Jacob simplification of Theis equation is not valid for short duration of step-drawdown tests; and (2) a large extrapolation will pose significant error in determining the actual aquifer drawdown at the pumping well. Both methods proposed by Dawson and Istok, therefore, are also inaccurate and impractical.

Well efficiency calculation in this study is based on the traditional concepts that well losses are caused by turbulent flow near and within the pumping well and aquifer drawdown is a result of laminar flow. The well losses can be described as a second-order function of pumping rate and aquifer drawdown is determined as a linear function of the pumping rate (Equation 5-28). For this study, it is believed that Equations 5-28 and 5-30 is adequate and applicable to calculate the well efficiency.

5.2.2.2 Calculation

Well loss and well efficiency can be calculated using graphical methods and computational approaches based on step-drawdown pumping test data. A simple graphical method that has been widely used is to plot s/Q versus Q (Bierschenk 1964). Rearranging Equation 5-28, s/Q can be expressed as:

$$\frac{s}{Q} = B + CQ \quad (5-31)$$

Based on Equation 5-31, s/Q versus Q plots should yield a straight line with slope C and y-axis intercept B .

The disadvantages of this graphical approach are: (1) high uncertainty because multiple steps (at least three) of step-drawdown test data may not adequately fit a straight line (low correlation coefficient); and (2) calculation error will increase significantly when the pumping rate is relatively low and well loss is small (nearly a horizontal line).

The straight line graphical method is not appropriate for analyzing the NoVOCsTM well step test data because s/Q versus Q plots are scattered. The data poorly match a straight line (correlation coefficient, R^2 , is less than 0.62; see Figures 5-20 and 5-21). In some cases, a straight line cannot be obtained. Examples of s/Q versus Q are presented in Figures 5-20 and 5-21.

A new graphical approach developed for this investigation was therefore used instead to calculate aquifer drawdown and well loss coefficients (B and C) in this study. The observed total drawdown (s) versus pumping rate (Q) is plotted and a best-fit second order polynomial function is generated using the least-square method (Figure 5-22 through Figure 5-24). Based on Equation 5-29, parameters B and C are determined by the best-fit curves. Figures 5-22 through 5-24 show that the correlation coefficients (R^2) of the best-fit equations range between 0.97 to 0.99. For the upper aquifer injection test, water level rise is used instead of drawdown (Figure 5-23).

Well efficiency calculation results are presented in Table 5-4. As shown in the table, the calculated well efficiencies for both shallow and deep NoVOCsTM wells are quite high, ranging from 77 to 99 percent. These efficiencies indicate that well losses through the well screen and sand pack are relatively low for

the pumping and injection rates used in the step tests. The well efficiency will decrease when pumping rates increase.

Table 5-4 also shows that the shallow well injection efficiency (average 97 percent) is higher than the pumping efficiency (average 82 percent). There are several explanations for the higher injection efficiency. First, the shallow well was redeveloped just before the injection test because of the inadvertent injection of turbid water from a dirty hose. The well was subsequently pumped intensively (five times the volume of water injected) to clean the well. Second, the injected water was clean tap water that was less turbid than the aquifer water being pumped. Third, uneven cuts of screen slots between the inside and the outside of the well screen may cause outward (injection) flow to be less turbulent than inward (pumping) flow.

The injection efficiency calculated using the step-injection test data is consistent with the well efficiency based on measured water level rises inside and outside of the well screen (upper piezometer data). Well efficiency was also evaluated using the dipole test data (see Section 5.5 of this report). The dipole test data may be more representative of the NoVOCsTM operation efficiency because injected water was drawn directly from the deep aquifer. Conversely, the injected water used for the upper aquifer injection test was clean tap water. Clean tap water has different physical and chemical characteristics (particularly turbidity, pH, and Eh) from the aquifer water, and it may have affected the injection test results.

5.3 AQUIFER HYDRAULIC PARAMETER CALCULATION

This section analyzes the data from the constant discharge pumping test conducted in the upper screened portion of the NoVOCsTM well and presents calculations of values for various aquifer hydraulic parameters. Many analytical models are available to analyze pumping test data and calculate aquifer hydraulic parameters. Different models were developed to simulate a variety of aquifer conditions. The first and most critical step in a pumping test data analysis is to select an appropriate model (or models) for the specific aquifer conditions, pumping and observation well construction, and pumping test configurations.

The analytical model for the NoVOCsTM well pumping test data evaluation was selected based on the site hydrogeologic conceptual model, the pumping test configuration (including pumping and observation well construction), and the pumping test drawdown response characteristics. Section 5.3.1 summarizes the site hydrogeology and presents the site hydrogeologic conceptual model. Section 5.3.2 describes the

pumping test configuration. Section 5.3.3 discusses the drawdown response characteristics of the pumping test. Section 5.3.4 discusses selection of the analytical model, and describes the selected model and its applicability. The results of parameter calculation are discussed in Section 5.3.5.

5.3.1 Site Hydrogeologic Conceptual Model

The site hydrogeology has been discussed in Section 2.5. The site hydrogeological conceptual model for the tested aquifer is summarized as follows:

- The aquifer is a thick layer of fine sand that is generally composed of artificial fill and shallow marine-deposited sediments. The aquifer extends from the ground surface to a depth of approximately 105 feet bgs across the site.
- The aquifer is underlain by an impermeable layer (aquitard) of clay (the B clay), which forms the base of the aquifer. Several less permeable layers such as dense or silty sand and the A silt/clay exist within the aquifer in variable thicknesses (generally less than a few feet); none of these less permeable layers behave as significant aquitards because they are relatively thin and lack lateral continuity.
- Although the aquifer is heterogeneous and anisotropic in a large scale, it can be considered homogenous and horizontally isotropic within the zone of pumping influence because the grain size of the fine sand layer is relatively uniform. The aquifer is vertically anisotropic.
- The aquifer is generally under unconfined conditions. The lower portion of the aquifer below the dense sand layer may be under semiconfined conditions.
- The initial water level in the tested aquifer was observed at approximately 17 feet bgs. Groundwater generally flows to the west toward San Diego Bay; however, the groundwater gradient is small and relatively flat.
- Groundwater recharge and discharge are primarily through lateral flow. Vertical infiltration is another source of groundwater recharge. No precipitation occurred during the pumping test period; therefore, the vertical recharge is negligible.
- San Diego Bay is considered a lateral boundary of the aquifer. However, the drawdown responses from the pumping test do not reach the bay, which is approximately 1,000 feet from the test site. Consequently, boundary effects of pumping are considered insignificant.
- The aquifer is tidally influenced. Tidal influence correction may be needed for the drawdown responses in the observation wells.

5.3.2 Constant Discharge Pumping Test Configuration

Pumping test configuration is important in selecting analytical models. Construction details of the pumping and observation wells, the pumping rate and duration, and the spatial orientation of the observation wells for this pumping test study are discussed in Sections 4.1 and 4.3. The constant discharge pumping test configuration was as follows:

- Groundwater was pumped from the upper screened interval of the NoVOCs™ well, which is 43 to 47 feet bgs.
- Pumping well diameter is 8 inches, and boring diameter is 14 inches (including sand pack).
- Pumping rate was kept constant at 20 gpm.
- Pumping duration was 32 hours.
- Initial groundwater level was approximately at 17 feet bgs.
- Saturated thickness of the tested aquifer was estimated at 88 feet.
- Drawdown was monitored in 10 observation wells surrounding the pumping well, but the data logger malfunctioned at two of the observation wells (MW-50 and -51).
- Distances between the observation wells and the pumping well range from 27.7 to 107.9 feet.
- Most of the observation wells have 5-foot screens, except for MW-54 which has a 40-foot screened interval.
- The observation wells are screened at various depths of the aquifer, ranging from 38 to 78 below ground surface.
- The pumping well and all of the observation wells are all partially penetrating wells.

Table 5-5 summarizes the pumping test configuration; this information was used for data interpretation and calculation of aquifer hydraulic parameters.

5.3.3 Drawdown Response Characteristics

In general, drawdown data from the pumping and observation wells are plotted in linear, semilogarithmic, and logarithmic scales. By comparing the drawdown plots with type curves, many important features of the aquifer conditions can be characterized. Some of the important features include well loss or wellbore

storage effects, pumping rate variations, leaky aquifer condition, positive (recharge) or negative (impermeable) boundaries, and delayed yield effects.

Evaluation of drawdown responses for this pumping test study is complicated because of tidal influences during the test. The magnitude of the maximum observed drawdowns in each of the observation wells is similar to the magnitude of the tidal fluctuations in the aquifer (see Figures 5-12 through 5-19).

Therefore, data cannot be analyzed before tidal correction is made. The tidal influence correction procedure and corrected drawdown results were described in Section 5.1 of this report. The drawdown data analysis of all the observation wells is based on the corrected data. The pumping well drawdown (more than 16 feet) was significantly greater than the tidal fluctuations in the groundwater level (less than 0.8 feet). Consequently, the pumping well data do not need correction for tidal influence.

Table 5-6 summarizes the drawdown responses for all wells during the constant discharge pumping test. The initial response time is the time at which drawdown in an observation well is first positively identified. The water levels were affected by tidal influence, and the maximum drawdown values presented in Table 5-6 may include numerical error caused by the tidal correction.

The initial response time and maximum drawdown observation wells show that the wells constructed at different depths all responded to pumping in the upper aquifer zone. There are slight variations in response time and maximum drawdown at the well cluster nearest to the pumping well (MW-45, MW-46, and MW-47). These slight variations disappeared with distance from the pumping well, as noted in well cluster MW-48 and MW-49, with the response time increasing and maximum drawdown decreasing with depth. This type of response shows that the vertical hydraulic connection between the upper aquifer zone and lower aquifer zone is good; the dense or silty sand layers do not behave as a significant aquitard.

Table 5-6 also shows that the maximum drawdown and response time in the observation wells vary inversely with distance from the pumping well. This inverse relationship indicates that the aquifer is relatively homogeneous and isotropic in horizontal directions.

The log-log plots of the drawdown data for the observation wells (Figures 5-25 through 5-32) shows that the early data follow the Neuman type curve A closely. These early data were recorded in a short period during which the tidal influence is insignificant; therefore, tidal correction is minimal. The corrected late drawdown data clearly show the delayed yield effects that may be attributed to delayed gravity water

releases near the water table or the vertical flow component caused by partially penetrating pumping and observation wells. The late data may also include errors in the tidal influence correction.

The following summarizes the drawdown responses of the observation wells during the constant discharge pumping test:

- Drawdown responses were identified in all of the observation wells within a radius of 108 feet; positive identification of drawdown is defined as drawdown is greater than 0.01 feet (any data recorded below 0.01 feet include significant transducer and data logger error).
- Early drawdown responses in the wells show that the data plots closely follow the Theis-type curve; the intermediate and later data indicate delayed gravity yield effects.
- In horizontal directions, maximum drawdown decreases, while the response time increases, with distance from the pumping well, suggesting horizontal homogeneity and isotropy of the aquifer.
- In vertical directions, slight differences in maximum drawdown and responding time were observed among the well clusters 30 feet away from the pumping wells. The differences are less distinguishable in the well cluster 60 feet from the pumping well. These differences may indicate that vertical anisotropy exists within the tested aquifer; however, a significant or continuous aquitard probably does not exist between the upper and lower aquifer zones.

5.3.4 Selection of Analytical Model

Based on the site hydrogeologic conceptual model, the pumping test configuration, and drawdown response analysis discussed in the previous sections, the tested aquifer is considered a thick unconfined aquifer with some vertical anisotropy. Both the pumping well and observation wells partially penetrate the aquifer. Neuman's delayed yield model for partially penetrating wells in an unconfined aquifer (Neuman 1975) was selected as the most appropriate analytical model for the pumping data test analysis.

Neuman's model simulates two stages of groundwater release from an unconfined aquifer to a pumping well. At the early stage of the test, groundwater is released from the aquifer by water pressure decreases and aquifer compression. At the later stage, groundwater is primarily released by gravity drainage of the aquifer matrix (delayed yield), which usually causes a decrease in the groundwater drawdown rate.

Four parameters can be calculated by curve matching techniques used in the Neuman method: transmissivity (T), storativity (S), specific yield (S_y), and Neuman delayed yield factor (β). Aquifer transmissivity is defined as hydraulic conductivity multiplied by aquifer thickness; it measures the volume of groundwater that flows through a vertical area defined by unit width and entire thickness of the aquifer per unit time under unit groundwater gradient. Storativity measures the aquifer potential for water release by pressure decrease and aquifer compression, defined as the volume of water released from storage per unit surface area of aquifer per unit decline in hydraulic head. Specific yield measures unconfined aquifer potential for water release by gravity drainage; it is defined as the volume of water released from storage in an unconfined aquifer per unit aquifer volume. The Neuman delayed yield factor measures the effect of delayed yield from vertical gravity drainage and is related to the ratio of vertical hydraulic conductivity to horizontal hydraulic conductivity (K_z/K_r), defined as follows (Neuman 1975):

$$\frac{K_z}{K_r} = \mathbf{b} \frac{b^2}{r^2} \quad (5-32)$$

where

β	=	Neuman delayed yield factor [dimensionless]
b	=	Saturated thickness of the aquifer [L]
r	=	Distance from the pumping well to the observation well [L]
K_z	=	Vertical hydraulic conductivity of the aquifer [LT^{-1}]
K_r	=	Horizontal hydraulic conductivity of the aquifer [LT^{-1}]

5.3.5 Results and Discussion

Aquifer hydraulic parameters were calculated using the groundwater pumping test data analysis software package AQTESOLV™ (Duffield and Rumbaugh 1991; HydroSOLVE 1996). The Neuman delayed yield model for partially penetrating wells in unconfined aquifers was selected to analyze the groundwater drawdown data corrected for tidal influence. Log-log plots of drawdown versus time were prepared, and the plots were matched visually with the Neuman type curves. The automatic matching option (using the least-square computational approach) offered by AQTESOLV™ was not used because the computational method is insensitive to the early data match and biased toward the data in the late stage of the test. The late data may include more errors caused by tidal influence and tidal correction. In addition, early data matched to Neuman's type curve A is important for accurate estimation of aquifer hydraulic parameters.

Figures 5-25 through 5-32 show the drawdown plots and the Neuman type curve matching for the various observation wells. As shown in the figures, the Neuman delayed yield type curves match well with the corrected drawdown plots. The drawdown data clearly illustrate the delayed gravity drainage effects. The curve matches in these figures indicate that the aquifer parameter calculation based on the pumping test data is representative.

Table 5-7 presents the results of the aquifer hydraulic parameter calculation using AQTESOLV™. The calculated aquifer hydraulic parameters are summarized as follows:

- The calculated aquifer transmissivity ranges from approximately 2,200 to 2,780 ft²/day. The aquifer hydraulic conductivity was calculated based on the saturated aquifer thickness of 88 feet, ranging from 25 to 32 feet per day (ft/day) or 0.009 to 0.011 cm/sec. The range of the estimated hydraulic conductivity is typical for fine sand, which is consistent with the aquifer's lithologic conditions at the site.
- The estimated aquifer storativity ranges from approximately 0.001 to 0.008. In the Neuman delayed yield model, storativity represents the elastic release of water from the aquifer matrix at an early stage of the pumping test.
- Specific yield of the testing aquifer ranges from 0.02 to 0.12, approximately one to two orders of magnitude greater than the storativity values. The estimated specific yield values are within the typical range for unconfined aquifers.
- The estimated ratio of vertical to horizontal hydraulic conductivity ranges from 0.08 to 0.3. The ratios were calculated from the Newman delayed yield factor based on equation 5-32. The calculated ratios indicate the aquifer is considerably anisotropic in the vertical direction.

Generally, the estimated aquifer hydraulic conductivity values may represent the average horizontal properties of the testing aquifer. The hydraulic conductivity values calculated from data for the observation wells near the pumping well may be more representative of the upper zone condition. The calculated transmissivity, storativity and specific yield values are relatively constant for various depths of screened intervals and different distances from the pumping well, showing that the hydraulic property of the aquifer is relatively homogeneous.

5.4 DETERMINATION OF GROUNDWATER FLOW PATTERNS

Previous site investigations indicate that groundwater generally flows west in the vicinity of the NoVOCs™ well. However, the mean groundwater flow direction and the horizontal and vertical

hydraulic gradients have not been adequately characterized in those investigations because tidal effects and variable groundwater densities caused by sea water intrusion were not considered. This section discusses the principles, procedures, and results of groundwater flow pattern determination, including mean groundwater level calculation from tidally influenced water levels and density correction for groundwater hydraulic gradient.

5.4.1 Mean Groundwater Level Calculation from Tidally Influence Water Levels

One widely applied method to calculate mean groundwater elevation from tidally influenced water levels was developed by Serfes (1991). The Serfes method is a three-step filtering approach (calculating moving averages) that uses hourly groundwater level data collected during a 70-hour period. The three-step filtering approach provides more accurate average groundwater levels than the straight arithmetic mean. The Serfes method was modified as explained below because water level data unaffected by aquifer testing for 70-hour periods were not available. The periods of data unaffected by pumping tests ranged from 30 to 62 hours. Also, the Serfes method was modified to allow the use of data collected more frequently than the 1-hour interval specified by Serfes (1991). Water levels were monitored at 20-minute intervals for the upper aquifer zone wells and at 15-second intervals for some of the lower aquifer zone wells.

The modified method is based on an average period of approximately 25 hours for a complete tidal cycle consisting of two high tides and two low tides. The procedures for the modified method for data of 20-minute frequency are as follows:

1. For a 50- to 75-hour groundwater elevation data series $\{H_i, i = 1, 2, \dots, n\}$ with $149 \leq n \leq 224$, compute the first sequence of means $\{X_j, j = 1, 2, \dots, n-74\}$ as follows:

$$X_j = \frac{1}{75} \sum_{m=0}^{74} H_{m+j} \text{ where } j = 1, 2, \dots, n-74 \quad (5-33)$$

where

$$\begin{aligned} X_j &= \text{The first sequence of means [L]} \\ H_{m+j} &= \text{Groundwater elevation data in 20-minute interval [L]} \end{aligned}$$

2. Then, the second sequence of means $\{Y_k\} \{k=1, 2, \dots, n-142\}$ is calculated as follows:

$$Y_k = \frac{1}{75} \sum_{m=0}^{74} X_{m+k} \quad \text{where } k = 1, 2, \dots, n-148 \quad (5-34)$$

where

$$\begin{aligned} Y_k &= \text{The second sequence of means [L]} \\ X_{m+k} &= \text{The first sequence of means [L]} \end{aligned}$$

3. Finally, the mean groundwater elevation M is calculated as follows:

$$M = \frac{1}{n-148} \sum_{k=1}^{n-148} Y_k \quad (5-35)$$

where

$$M = \text{The mean groundwater elevation [L]}$$

The mean groundwater elevations for wells MW-45, MW-47, and the upper screen of the NoVOCs™ well were calculated using an electronic spreadsheet following the procedures above. Groundwater level data for wells MW-48, MW-49, MW-52, and MW-53 were recorded in 15-second intervals; therefore, calculation procedures for the mean elevation were further modified to use all the data that had been collected. The principle of this modification is the same as discussed above.

The mean groundwater elevations calculated for wells MW-45, MW-48, MW-52, and the upper screen of the NoVOCs™ well represent groundwater flow patterns in the upper aquifer zone. The mean groundwater flow direction in the lower aquifer zone was characterized by the mean water elevation data from wells MW-47, MW-49, and MW-53. Data for other monitoring wells were not used because the wells were either constructed between the two zones or fully penetrate the aquifer. Groundwater elevation data for some of the wells are not available.

5.4.2 Density Correction of Groundwater Levels

Evaluation of groundwater flow pattern in the vicinity of the NoVOCs™ well is further complicated by seawater intrusion. The salinity of groundwater at the site is generally 2 to 3 percent and the density of groundwater samples from almost all the monitoring wells is greater than 1 gram/cubic centimeter (g/cm^3). In addition, groundwater density varies by well location and depth. In general, the density of

groundwater is higher in the lower aquifer zone. In the following sections, the calculation of equivalent fresh-water heads and the correction of groundwater levels measured by pressure transducers are discussed.

5.4.2.1 Calculation of Equivalent Fresh-Water Heads

Calculation of equivalent fresh-water heads (elevations) from an aquifer with variable water density is the first step of the density correction. Equivalent fresh-water heads plotted on maps and contoured are necessary to estimate horizontal groundwater flow direction and hydraulic gradient. The apparent head measurements in a density-variable aquifer should not be used to plot groundwater level contour maps: the contours of such plots will be misleading because the density effect can cause water to flow from apparent low to apparent high heads.

The following discussion presents the principles and procedures for calculating the equivalent fresh-water head. Density correction procedures for data collected by pressure transducer are different from those for manual measurements using water level indicators.

Groundwater hydraulic head is a sum of elevation head and pressure head, described as follows (Freeze and Cherry 1979):

$$h = z + \Psi \quad (5-36)$$

where

h	=	The hydraulic head [L]
z	=	Elevation of the point of measurement [L]
Ψ	=	The pressure head [L]

The pressure head of groundwater is a function of gage pressure and groundwater density; therefore, the hydraulic head can be further defined as follows:

$$h = z + \frac{P}{\rho g} \quad (5-37)$$

where

- p = Groundwater gage pressure [ML⁻¹T⁻²]
- ρ = Groundwater density [ML⁻³]
- g = Gravitational acceleration [LT⁻²]

Equation 5-37 shows that the hydraulic head (h) for higher density water will be less than the hydraulic head for fresh water under the same pressure and elevation conditions. Groundwater does not necessarily flow from the higher head to the lower head under this circumstance.

From Equation 5-37, the measured groundwater elevation above the MLLW in a monitoring well at the site is as follows:

$$h = z + \frac{p}{\rho_b g} \quad (5-38)$$

where

- h = The measured groundwater elevation using water level indicator [L]
- ρ_b = Density of groundwater in the well [ML⁻³]
- z = Elevation of the middle point of the well screen above (positive) or below (negative) a datum [L]
- p = Groundwater gage pressure at the middle point of the well screen [ML⁻¹T⁻²]

Also from Equation 5-37, the equivalent fresh-water head above the datum in the monitoring well is given by:

$$h^* = z + \frac{p}{\rho_0 g} \quad (5-39)$$

where

- h* = Equivalent fresh water head above the datum [L]
- ρ₀ = Density of fresh water (assumed to be 1) [ML⁻³]

Considering that the gage pressure of groundwater in the well is constant, Equations 5-38 and 5-39 can be combined to obtain the following equation:

$$(h^* - z)\rho_b g = (h - z)\rho_b g \quad (5-40)$$

Rearranging Equation 5-40 and substituting specific gravity $\gamma = \rho_b/\rho_0$ into the equation, the equivalent fresh-water head, h^* , is defined as follows:

$$h^* = \gamma h + (1 - \gamma)z \quad (5-41)$$

where

$$\gamma = \text{Specific gravity of the groundwater [dimensionless]}$$

Equation 5-41 should be used to calculate equivalent fresh-water head based on the water level measurements collected manually by water level indicators. Equation 5-41 may be used for pressure transducer data under certain circumstances, as explained in the next section.

5.4.2.2 Correction of Groundwater Levels Measured by Pressure Transducer

Pressure transducers measure water pressure. The water pressure reading is usually converted by data logger software to a water head above the transducer. The conversion is usually based on the density of fresh water (Equation 5-39). If the water density differs from that of fresh water but the conversion is based on fresh water, the resulting water head value will be the fresh water equivalent head relative to the transducer. If the conversion is based on the actual density of the water (Equation 5-38), the resulting water head value will be the actual water head relative to the transducer. Correcting pressure transducer data for density effects depends on whether raw pressure data were converted to heads using fresh water density or actual water density. Correcting the data also depends on (1) the manner in which the data logger software processes the data, (2) whether initial water levels input into the data logger have been corrected for density effects, and (3) whether multiple manual water level measurements are available for the data recording period. Several cases of data handling are discussed below (data logger configurations are described in bold, followed by an explanation of corrections that should be applied):

- **Case 1: The actual density of the groundwater was measured and the data logger used actual density to convert pressure data to water head above the transducer. The initial water level, measured manually and input into the data logger, was not corrected for density effects.**

All water levels recorded by the data logger are actual water levels and not fresh-water equivalent water levels. Equation 5-41 should be used to convert all water level data output from the data logger.

- **Case 2: The actual density of the groundwater was measured. The initial water level (manually measured) was corrected to a fresh-water equivalent using Equation 5-41 and input into the data logger. The data logger used fresh-water density to convert pressure to fresh-water equivalent head above the transducer. The data logger was set up to record changes from the initial water level.**

No additional density correction is required. All data logger output will be fresh-water equivalent water levels.

- **Case 3: Actual density of groundwater was not considered in the data logger configuration. Multiple manual measurements of water levels were collected during the recording period.**

Using the manual measurements, which represent the apparent groundwater elevations, the pressure transducer data should be adjusted to also represent apparent groundwater elevations. Equation 5-41 can then be applied to the entire adjusted data set to obtain equivalent fresh-water elevations.

- **Case 4: Actual density of groundwater was not considered in the data logger configuration. Only initial manual measurement of water levels was collected during the recording period.**

The change in water level from the initial data point should be calculated for each pressure transducer data point. The initial pressure transducer data point should be adjusted to represent the apparent water level elevation based on the initial manual water level measurement. Equation 5-41 should be applied to the adjusted initial groundwater elevation to obtain the initial fresh-water equivalent elevation. No density correction is needed for the water-level changes calculated from the pressure transducer data. The water-level changes should be directly added to or subtracted from the density-corrected initial groundwater elevation to obtain fresh-water equivalent elevations for the entire data set.

5.4.3 Corrected Water Levels and Horizontal Groundwater Flow Direction

Groundwater elevations and drawdown changes were measured using pressure transducers during the various phases of the aquifer tests. Manual water level measurements were also collected at the pumping well and at most observation wells during the tests. The data were corrected following the procedures specified for the Case 3 and Case 4 examples discussed in the previous section. The corrected results are presented in Appendixes C through G.

Static groundwater levels were corrected for tidal influence following the procedures discussed in Section 5.4.1. Mean groundwater elevations for the upper aquifer zone were calculated using the upper screen of NoVOCsTM well and the three upper zone NoVOCsTM observation wells (MW-45, MW-48, and MW-52). Mean groundwater elevations for the lower aquifer zone were calculated using the three lower zone NoVOCsTM observation wells (MW-47, MW-49, and MW-53). The mean groundwater elevations after tidal correction are listed in Table 5-8.

The equivalent fresh-water heads of the mean groundwater elevations were calculated following the procedures discussed in Section 5.4.2. The first step of the calculation is to obtain density data for various monitoring well locations and aquifer depths because the groundwater density was not directly measured. Jacobs Engineering Group, Inc. (1995b) applied an empirical equation developed by de Marsily (1986) to calculate groundwater density from total dissolved solids (TDS) data. The empirical equation was developed based on a laboratory test with sodium chloride solution and a linear regression analysis.

The empirical equation developed by de Marsily (1986) is as follows:

$$\rho = (6.87 \times 10^{-4} C_{TDS}) + 998.4575 \quad (5-42)$$

where

$$\begin{aligned} \rho &= \text{Groundwater density (kg/m}^3\text{)} \\ C_{TDS} &= \text{TDS concentration (mg/L)} \end{aligned}$$

The groundwater density and results for equivalent fresh-water head calculation are presented in Table 5-8.

The mean equivalent fresh-water head contours for the upper aquifer zone are plotted in Figures 5-33 and 5-34. Figure 5-33 is based on four points (including data for well MW-48), and Figure 5-34 is based on three points (excluding data for well MW-48). The two presentations (with and without data for well MW-48 data) are provided because the screen of well MW-48 is at a lower elevation than in the other three wells used to construct the contours. The mean equivalent fresh-water head contours for the lower aquifer zone are plotted in Figure 5-35. These contour maps represent the mean static water levels and flow directions with tidal and pumping influences removed. Effects caused by variation in groundwater

density variation were also corrected. These contour maps are considered representative of the natural groundwater flow pattern.

As shown in Figures 5-33, 5-34, and 5-35, groundwater generally flows to the west or northwest in both of the upper and lower aquifer zones. The horizontal hydraulic gradient in both aquifer zones is relatively flat, ranging from 0.005 to 0.01 feet per feet in the upper zone and approximately 0.006 in the lower zone. Data for generating the contour maps were limited (four points for the upper aquifer zone and three points for the lower aquifer zone) because other NoVOCsTM observation wells were completed at depths between the two aquifer zones. Also, data were not available for some of the observation wells because of data logger malfunction.

5.4.4 Vertical Hydraulic Gradient Correction

Calculation of vertical hydraulic gradient in a fresh-water aquifer (groundwater density of 1 g/cm³) is simple: for two vertically aligned wells, the vertical hydraulic gradient equals the head difference between the wells divided by the distance between the midpoint of the well screen intervals. However, calculation of vertical hydraulic gradient in a density-variable aquifer is relatively complex. Incorrect calculations of the vertical hydraulic gradient by simply using equivalent fresh-water heads to determine the head difference are common. The vertical hydraulic gradient in a density-variable aquifer is a function of the equivalent fresh-water heads, the distance between the two intervals, and the groundwater density. This section discusses the principles and the reason for calculating vertical hydraulic gradient differently from the horizontal hydraulic gradient. The procedures to calculate the vertical hydraulic gradient in a density-variable aquifer are also presented.

Vertical hydraulic gradient is not calculated in this report because limited groundwater density data are available. Also, vertical hydraulic gradient was not identified as a key parameter in the pumping test data analysis and NoVOCsTM well evaluation. The equations and procedures discussed in this section can be followed in future data analysis for the vertical hydraulic gradient at the site.

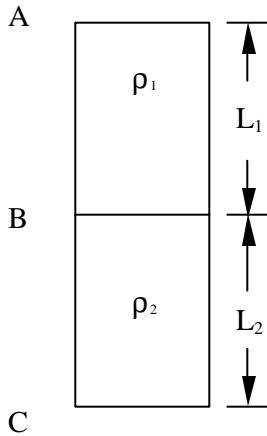

Considering water column ABC filled with a porous medium as shown in the Drawing: the upper portion, AB, has a height L_1 and contains water (or any fluid) with a density equal to ρ_1 ; the lower portion, BC, has a height of L_2 and contains water with a density equal to ρ_2 . Water in the column is assumed to be in a hydraulic steady state, that is, no vertical flow occurs. Vertical hydraulic gradient is to zero between any two points within the column. Also, it is assumed that no density-driven flow and no density diffusion occur across the boundary line B.

If the bottom of the column is set at the datum, that is, the elevation z equals zero at point C, from Equation 5-39, the equivalent fresh water-head at the three points (A, B, and C) will be given as:

$$h_A^* = z_A + \frac{p_A}{\rho_0 g} \quad (5-43)$$

$$h_B^* = z_B + \frac{p_B}{\rho_0 g} \quad (5-44)$$

$$h_C^* = z_C + \frac{p_C}{\rho_0 g} \quad (5-45)$$

where

$p_A, p_B,$ and p_C = The groundwater pressure gages at points A, B, and C

$z_A, z_B,$ and z_C = The elevations of points A, B, and C

Equations 5-43, 5-44, and 5-45 can be solved as follows, considering $p_A=0, p_B=\rho_1 g L_1, p_C=\rho_1 g L_1 + \rho_2 g L_2, z_A=L_1+L_2, z_B=L_2,$ and $z_C=0$:

$$h_A^* = (L_1 + L_2) + 0 = L_1 + L_2 \quad (5-46)$$

$$h_B^* = L_2 + \frac{\mathbf{r}_1 g L_1}{\mathbf{r}_0 g} = \mathbf{g}_1 L_1 + L_2 \quad (5-47)$$

$$h_C^* = 0 + \frac{(\mathbf{r}_1 L_1 + \mathbf{r}_2 L_2)g}{\mathbf{r}_0 g} = \mathbf{g}_1 L_1 + \mathbf{g}_2 L_2 \quad (5-48)$$

Because $\gamma_1 \neq \gamma_2 \neq 1$, Equation 5-46, 5-47, and 5-48 show that the equivalent fresh-water heads at the three points are not equal. This result contradicts the assumption that no vertical flow occurs in the water column. Therefore, the difference in the two equivalent fresh-water heads divided by the distance between the two points does not equal the vertical hydraulic gradient in aquifers with variable density groundwater.

In general, the vertical hydraulic gradient between two vertically aligned points within variable density groundwater equals the difference of the fresh-water equivalent heads at the two points divided by the distance plus a constant. That is:

$$I_{AB} = \frac{h_A^* - h_B^*}{L_1} + C_1 \quad (5-49)$$

$$I_{BC} = \frac{h_B^* - h_C^*}{L_2} + C_2 \quad (5-50)$$

$$I_{AC} = \frac{h_A^* - h_C^*}{L_1 + L_2} + C_3 \quad (5-51)$$

where

- I_{AB} = Vertical hydraulic gradient between points A and B.
- I_{BC} = Vertical hydraulic gradient between points B and C.
- I_{AC} = Vertical hydraulic gradient between points A and C.

From Equations 5-46, 5-47, and 5-48, considering $I_{AB} = I_{BC} = I_{AC} = 0$, for steady state condition, we can solve C_1 , C_2 and C_3 as:

$$C_1 = \frac{h_B^* - h_A^*}{L_1} = \frac{g_1 L_1 + L_2 - (L_1 + L_2)}{L_1} = g_1 - 1 \quad (5-52)$$

$$C_2 = \frac{h_C^* - h_B^*}{L_2} = \frac{g_1 L_1 + g_2 L_2 - (g_1 L_1 + L_2)}{L_2} = g_2 - 1 \quad (5-53)$$

$$C_3 = \frac{h_C^* - h_A^*}{L_1 + L_2} = \frac{g_1 L_1 + g_2 L_2 - (L_1 + L_2)}{L_1 + L_2} = \frac{g_1 L_1 + g_2 L_2}{L_1 + L_2} - 1 \quad (5-54)$$

Therefore, vertical hydraulic gradient between any two points in an aquifer with density-variable groundwater can be calculated using the following general equation (based on Equations 5-49 through 5-54):

$$I_v = \frac{h_u^* - h_l^*}{l} + (g - 1) \quad (5-55)$$

where

- I_v = Vertical hydraulic gradient between two vertically aligned points within the aquifer (positive value represents downward gradient) [dimensionless]
- h_u, h_l = The equivalent fresh water heads at the two points (higher elevation and lower elevation points, respectively) [L]
- l = Vertical distance between the two points [L]
- γ = Specific gravity of groundwater between the two points [dimensionless]

The specific gravity of groundwater between the two points should be carefully chosen when Equation 5-55 is used. If the groundwater density is not constant between the upper and lower aquifer zones, a thickness-weighted average of the specific gravity for multiple density strata should be used. The weighted average of the specific gravity is calculated as follows:

$$g = \frac{\sum_{i=1}^n g_i l_i}{\sum_{i=1}^n l_i}, \quad i = 1, 2, \dots, n \quad (5-56)$$

where

- γ = The weighted average of the specific gravity of groundwater
 γ_i = The specific gravity of the i^{th} strata
 l_i = The thickness of the i^{th} strata

5.5 DIPOLE FLOW TEST

The dipole flow test (DFT), a new single-well hydraulic test for aquifer characterization, was first proposed by Kabala (1993). The test was designed to characterize the vertical distribution of local horizontal and vertical hydraulic conductivities near the test well. Measures of the aquifer's anisotropy ratio and storativity can also be obtained through DFT data analysis. DFT is a cost-effective method for aquifer hydraulic characterization because (1) the test duration is short; the test generally lasts no more than a few hours, and (2) no investigation-derived waste is generated because the water from the pumping chamber is injected to the aquifer through recharge chamber.

5.5.1 Mathematical Models

Kabala (1993) presented a mathematical model describing drawdown (or water level rise) during a dipole flow test in each of the isolated chambers of a well situated in a leaky homogeneous anisotropic aquifer. Major assumptions for this original model are:

- The aquifer is homogeneous and anisotropic and horizontally situated
- The aquifer is under either leaky or confined conditions
- The test well fully penetrates the aquifer thickness
- Water is removed through one of the two open screened intervals and discharged to another interval instantaneously
- Linear vertical head distribution is assumed in the semiconfining layer (leaky aquitard)

- Water storage in the leaky aquitard is negligible
- Flows in the aquifer zones are mainly horizontal, but primarily vertical within the leaky aquitard
- Well bore storage and well losses are insignificant
- “Skin effect” (short-circuiting through the sand packs) is negligible

The analytical solutions for drawdown in the pumping chamber and water level rise in the recharge chamber are presented by Kabala (1993). The transient solution describing drawdown is given as follows:

$$s(t) = \frac{Q}{4pK_r b} \left\{ W(u_r; \beta_w) + \frac{2b^2}{4p^2 \Delta^2} \sum_{n=1}^{\infty} \frac{1}{n^2} \left[\sin \frac{np(d+2\Delta)}{b} - \sin \frac{npd}{b} \right]^2 W\left[u_r; \left(\beta_w^2 + \frac{(npr_w)^2}{a^2 b^2}\right)^{1/2}\right] \right\} \quad (5-57)$$

where

- $s(t)$ = Drawdown in the pumping chamber [L]
 t = Time since beginning of the test [L]
 Q = Pumping rate [$L^3 T^{-1}$]
 K_r = Horizontal hydraulic conductivity [LT^{-1}]
 b = Aquifer thickness [L]
 d = Distance from the top of aquifer to the top of the upper chamber [L]
 Δ = Half of the length of the screen interval [L]
 a^2 = Aquifer anisotropy ratio, defined as K_r/K_z [dimensionless]
 $W(u_r, \beta_w)$ = Leaky aquifer well function, defined as:

$$W(u_r; \beta_w) = \int_{u_r}^{\infty} \frac{1}{y} \exp\left(-y - \frac{\beta_w^2}{4y}\right) dy \quad (5-58)$$

where

- u_r = Dimensionless time, defined as: $r_w^2 S_s / 4K_r t$
 β_w = Leaky factor defined as: $r_w / (K_r b b' / K')^{1/2}$
 r_w = Radius of the well casing [L]
 S_s = Aquifer specific storage [L^{-1}]

- b' = Aquitard (semi-confining layer) thickness [L]
 K' = Aquitard vertical hydraulic conductivity [LT^{-1}]

A similar solution can be derived to describe water level rise due to injection in the recharge chamber with a negative pumping rate. Combining the pumping and injection effects, the actual drawdown in the pumping chamber is given by:

$$\begin{aligned}
 s(t) = & \frac{Q}{pK_r b} \sum_{n=1}^{\infty} \left[\frac{\sin(n p \Delta / b)}{n p \Delta / b} \right]^2 \\
 & \cdot \sin\left(n p \frac{l+d}{2b}\right) \sin\left(n p \frac{l-d-2\Delta}{2b}\right) \cos\left(n p \frac{d+\Delta}{b}\right) \cdot W\left[u_r; \left(b_w^2 + \frac{(n p r_w)^2}{a^2 b^2}\right)^{1/2}\right] \quad (5-59)
 \end{aligned}$$

The solution for actual water level rise in the recharge chamber is given by:

$$\begin{aligned}
 s(t) = & \frac{Q}{pK_r b} \sum_{n=1}^{\infty} \left[\frac{\sin(n p \Delta / b)}{n p \Delta / b} \right]^2 \\
 & \cdot \sin\left(n p \frac{l+d}{2b}\right) \sin\left(n p \frac{l-d-2\Delta}{2b}\right) \cos\left(n p \frac{l-\Delta}{b}\right) \cdot W\left[u_r; \left(b_w^2 + \frac{(n p r_w)^2}{a^2 b^2}\right)^{1/2}\right] \quad (5-60)
 \end{aligned}$$

Equations (5-59) and (5-60) are the transient solutions for the dipole flow test. The steady state solution for drawdown in the pumping chamber is as follows:

$$\begin{aligned}
 s(t) = & \frac{2Q}{pK_r b} \sum_{n=1}^{\infty} \left[\frac{\sin(n p \Delta / b)}{n p \Delta / b} \right]^2 \\
 & \cdot \sin\left(n p \frac{l+d}{2b}\right) \sin\left(n p \frac{l-d-2\Delta}{2b}\right) \cos\left(n p \frac{d+\Delta}{b}\right) \cdot K_0\left[\left(b_w^2 + \frac{(n p r_w)^2}{a^2 b^2}\right)^{1/2}\right] \quad (5-61)
 \end{aligned}$$

Where

- K_0 = Zero-order modified Bessel function of the second kind,
 l = Distance from the top of the aquifer to the bottom of the lower screen.

5.5.2 Modified Dipole Flow Test Solution for Wellbore Storage

Kabala (1998) developed a new DFT model to account for wellbore storage effects in the pumping and injection chambers. In the wellbore storage DFT model, measured drawdown (or water level rise) is the

sum of aquifer drawdown and wellbore storage drawdown. Dimensionless wellbore storage parameters for the pumping and recharge chambers are defined as:

$$C_{PD} = \frac{(r_i / r_w)^2}{4S} \quad (5-62)$$

$$C_{RD} = \frac{1 - (r_i / r_w)^2}{4S} \quad (5-63)$$

where

- C_{PD} = Dimensionless wellbore storage parameter for the pumping chamber
- C_{RD} = Dimensionless wellbore storage parameter for the recharge chamber
- r_i = Radius of inner well casing (eductor pipe)[L]
- r_w = Radius of well casing [L]
- S = Aquifer storativity or specific yield [dimensionless]

Laplace transformation is used to solve the partial differential equations that describe drawdown (or water level rise) in the pumping (or recharge) chamber during the DFT where the wellbore storage effect is considered. The drawdown in the pumping chamber s_{pump} can be described as:

$$s_{pump}(p) = s_{pp}(p) + s_{pi}(p) \quad (5-64)$$

where p is the Laplace transformation variable, $s_{pp}(p)$ is the drawdown caused by pumping, and $s_{pi}(p)$ is the water level caused by injection (expressed as negative drawdown). The two components of the water level response are defined as follows:

$$s_{pp}(p) = \frac{Q}{4pK_r b} \cdot \frac{\frac{2}{p} K_0(\sqrt{p}) + 4 \sum_{n=1}^{\infty} \frac{a_n^2}{p} K_0(\sqrt{p + g_n^2})}{C_{PD} p^2 \left[\frac{2}{p} K_0(\sqrt{p}) + 4 \sum_{n=1}^{\infty} \frac{a_n^2}{p} K_0(\sqrt{p + g_n^2}) \right] + 1} \quad (5-65)$$

and

$$s_{pi}(p) = \frac{-Q}{4pK_r b}$$

$$\cdot \left\{ 1 - \frac{\left[\frac{2}{p} K_0(\sqrt{p}) + 4 \sum_{n=1}^{\infty} \frac{b_n^2}{p} K_0(\sqrt{p + g_n^2}) \right] \left[\frac{2}{p} K_0(\sqrt{p}) + 4 \sum_{n=1}^{\infty} \frac{a_n^2 b_n^2}{p} K_0(\sqrt{p + g_n^2}) \right]}{C_{RD} p^2 \left[\frac{2}{p} K_0(\sqrt{p}) + 4 \sum_{n=1}^{\infty} \frac{b_n^2}{p} K_0(\sqrt{p + g_n^2}) \right] + 1} \right\} \quad (5-66)$$

Variables α_n , β_n , and γ_n are defined as follows:

$$a_n = \frac{b}{np\Delta_u} \cdot \sin\left(\frac{np\Delta_u}{b}\right) \cdot \cos\left[\frac{np(d + \Delta_u)}{b}\right] \quad (5-67)$$

$$b_n = \frac{b}{np\Delta_l} \cdot \sin\left(\frac{np\Delta_l}{b}\right) \cdot \cos\left[\frac{np(l - \Delta_l)}{b}\right] \quad (5-68)$$

$$g_n = \frac{np r_w}{b \sqrt{K_r / K_z}} \quad (5-69)$$

where:

Δ_u = Half of the upper screened interval [L]

Δ_l = Half of the lower screened interval [L]

5.5.3 Dipole Flow Test Data Interpretation and Aquifer Anisotropy Estimation

The dimensionless drawdown in the pumping chamber versus dimensionless time can be plotted as groups of type curves with different anisotropy ratios ($a^2 = K_r/K_z$) and storativity (or specific yield) values. The type curves are generated by plotting dimensionless drawdown s_D versus dimensionless time τ , which are defined as follows:

$$s_D = \frac{s(t)}{s(\infty)} \quad (5-70)$$

and

$$t = \frac{n t}{r_w^2} \quad (5-71)$$

where

- $s(\infty)$ = Steady state drawdown or water level rise during the DFT [L]
 v = Aquifer hydraulic diffusivity, defined as T/S or K_r/S_s [L^2T^{-1}]

Drawdown (or water level rise) data collected during the DFT then be normalized to dimensionless drawdown (or water level rise) with values ranging from 0 to 1, as follows:

$$s_D(t) = \frac{s(t+t_0) - s_{\min}}{s_{\max} - s_{\min}} \quad (5-72)$$

where

- $s_D(t)$ = Normalized dimensionless drawdown (or water level rise)
 $s(t+t_0)$ = Drawdown (or water level rise) at time $t+t_0$ [L]
 t_0 = The beginning time of a given step of the DFT [T]
 s_{\max} = The maximum drawdown (or water level rise) during a given step of the DFT [L]
 s_{\min} = The minimum drawdown (or water level rise) during a given step of the DFT [L]

The normalized drawdown or water level rise versus time are plotted for the type curve match. A scale factor (A) is applied to the real-time plots. The scale factor is applied for two purposes: (1) transferring real time to dimensionless time so the horizontal axes of the type curves and test data are comparable, and (2) adjusting the horizontal positions of the data plots so that a best match to one of the type curves can be obtained. The scale factor is defined as:

$$A = \frac{n}{r_w^2} = \frac{K_r}{S_s r_w^2} \quad (5-73)$$

From the type curve match, the aquifer anisotropy ratio is obtained from the value of parameter a^2 (which equals K_r/K_z). In addition, aquifer horizontal hydraulic conductivity can be calculated from the values of parameters S (or S_y), and A . The aquifer horizontal hydraulic conductivity K is calculated by the following equation:

$$K_r = \frac{A \cdot r_w^2 S}{b} \quad (5-74)$$

DFT data collected during Step 4 recovery in the recharge chamber were considered the most suitable for parameter estimation because the water level rise data were least affected by variations in pumping rate variations and head fluctuations.

Tidal influence during the DFT is removed using data collected from well MW-51. Comparison of water level data from the NoVOCsTM well and observation well MW-51 shows that the tidal fluctuations in the two wells are almost identical. Well MW-51 also had minimum impact from the DFT because of its distance from the NoVOCsTM well. The least-square algorithm was used to simulate the tidal fluctuations in the NoVOCsTM well. The drawdown (or water level rise) correction procedure is similar to the procedures presented in Section 5.1.

Figure 5-36 shows the recovery data plots and type curve match for the DFT Step 4 recharge chamber. The type curves are generated using the DFT model considering well bore storage. The group of the type curves in Figure 5-36 represents storativity $S=0.01$ and anisotropy ratios $a^2 = K_r/K_z = 100, 30, 10, 3,$ and 1 . The normalized dimensionless DFT recovery data with time are represented by circles, whereas the normalized recovery data versus scaled time (dimensionless time) are plotted as thick dash line.

From the DFT recovery data plots and type curve match (Figure 5-36), the aquifer hydraulic parameters are estimated as: $K_r = 0.0115 \text{ cm/sec}$, $0.001 \leq S \leq 0.01$, and $K_r/K_z = 4.93$. These results are very close to the parameter estimated by interpreting pumping test data (Section 5.3). The aquifer hydraulic parameters estimated through DFT are also presented in Table 5-7.

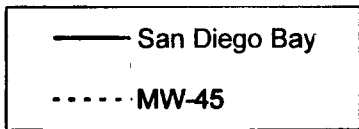
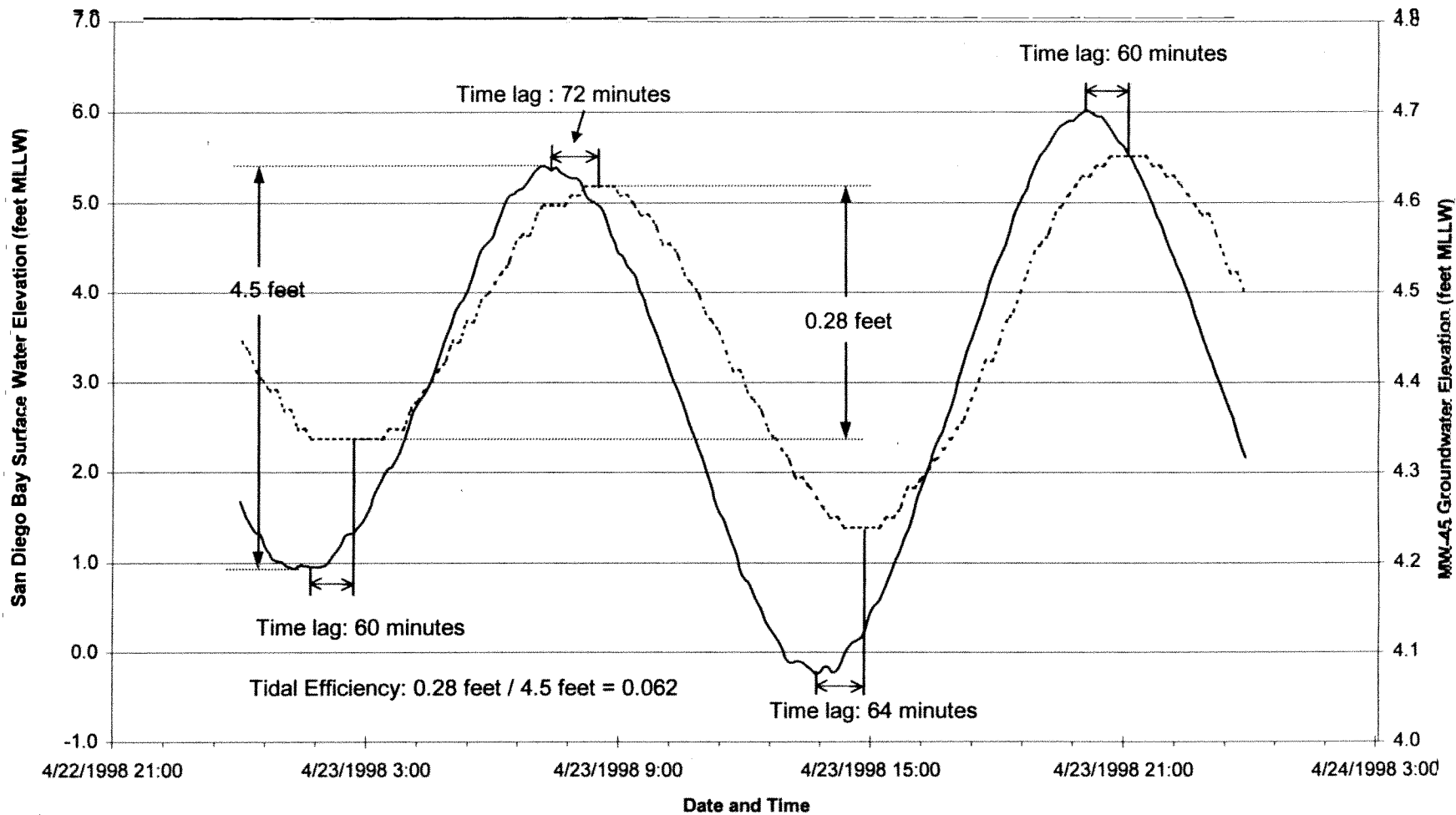

NAS NORTH ISLAND SITE 9
 NoVOCs™ HYDROGEOLOGICAL INVESTIGATION

FIGURE 5-1
 WATER LEVEL COMPARISON BETWEEN
 SAN DIEGO BAY AND
 OBSERVATION WELL MW45

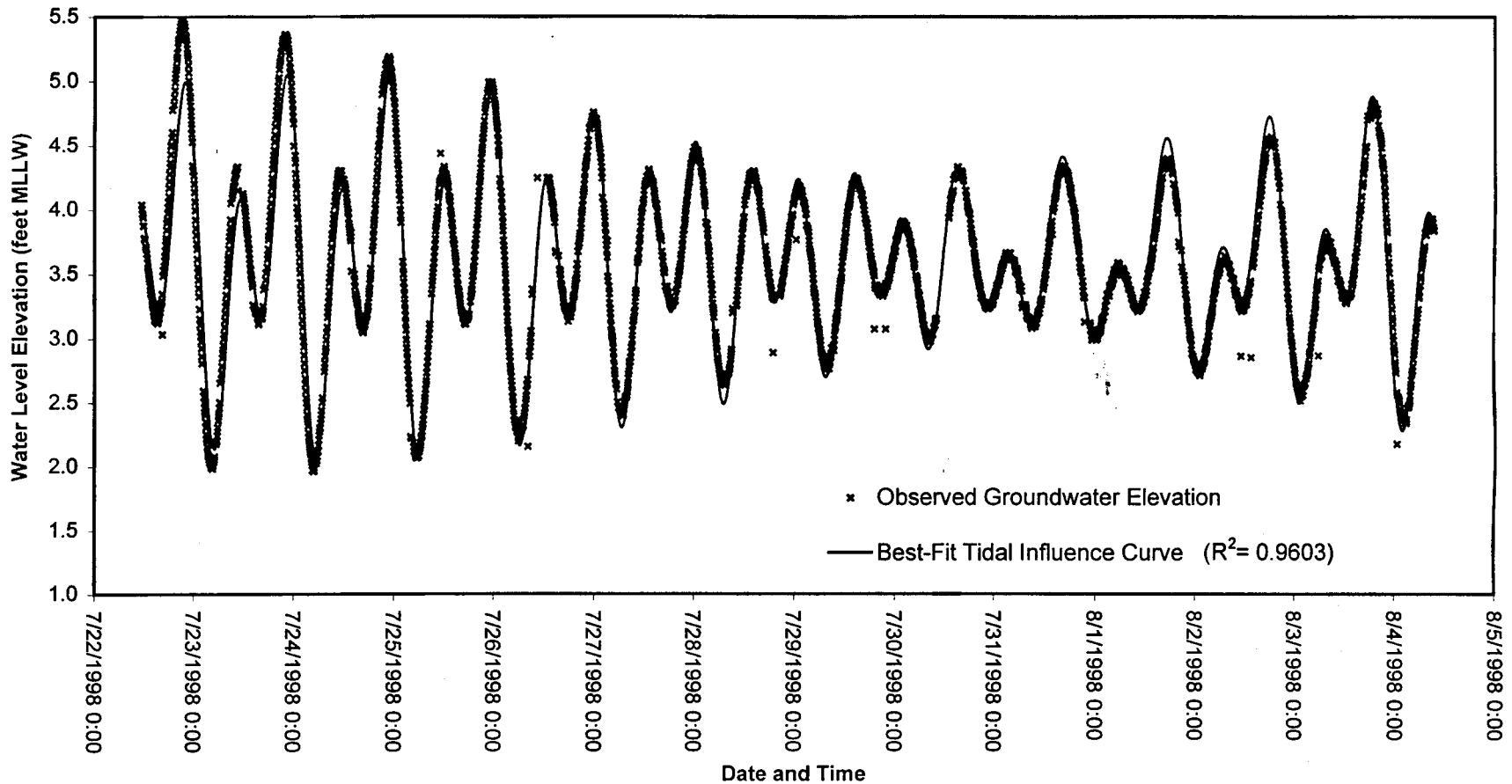

NAS NORTH ISLAND SITE 9
 NoVOCs™ HYDROGEOLOGICAL INVESTIGATION

FIGURE 5-2
 OBSERVED GROUNDWATER ELEVATION AND
 BEST-FIT TIDAL INFLUENCE CURVE
 FOR WELL MW20

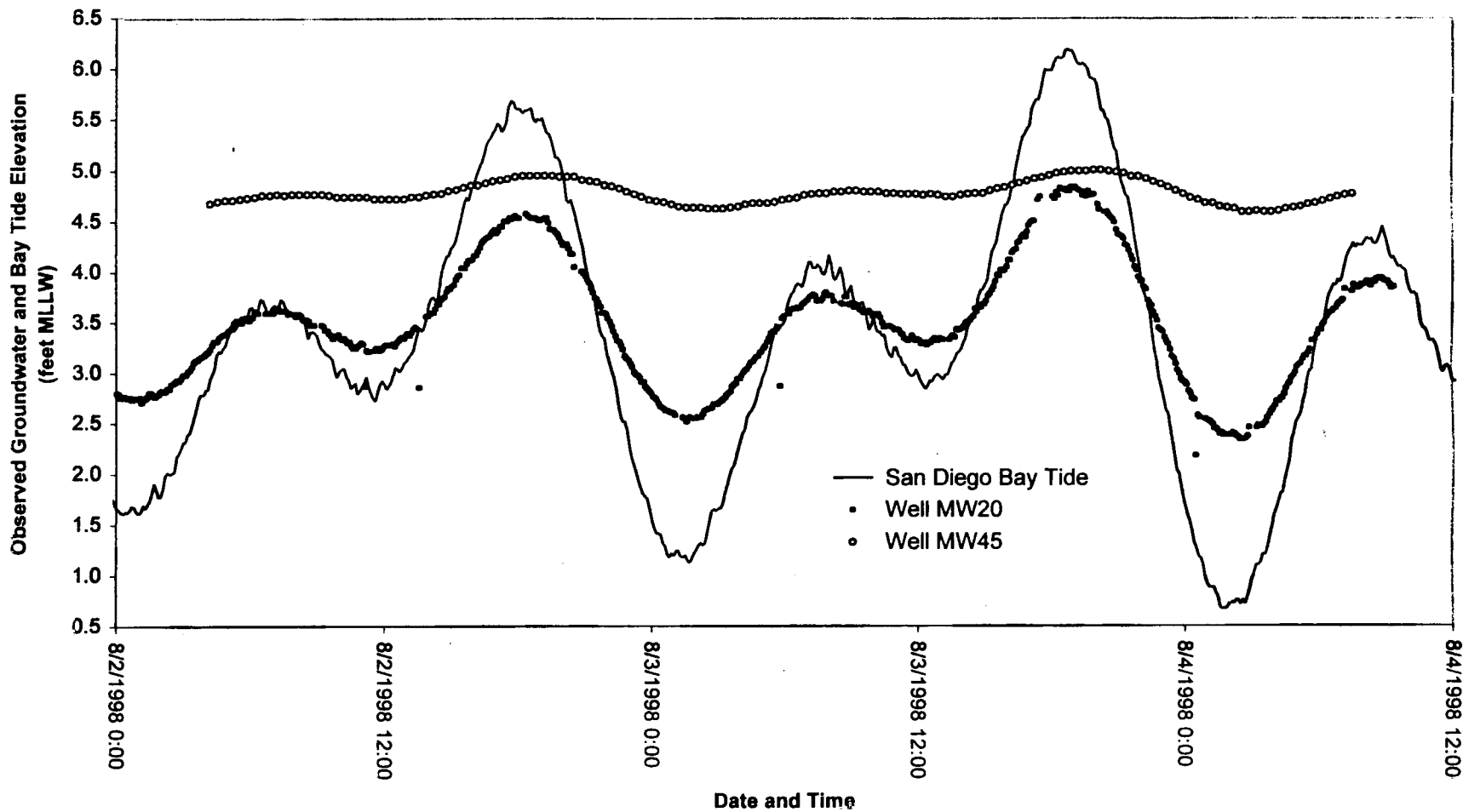

NAS NORTH ISLAND SITE 9
 NoVOCs™ HYDROGEOLOGICAL INVESTIGATION

FIGURE 5-3
 OBSERVED WATER LEVEL COMPARISON
 AMONG
 BAY TIDE, MW20 AND MW45

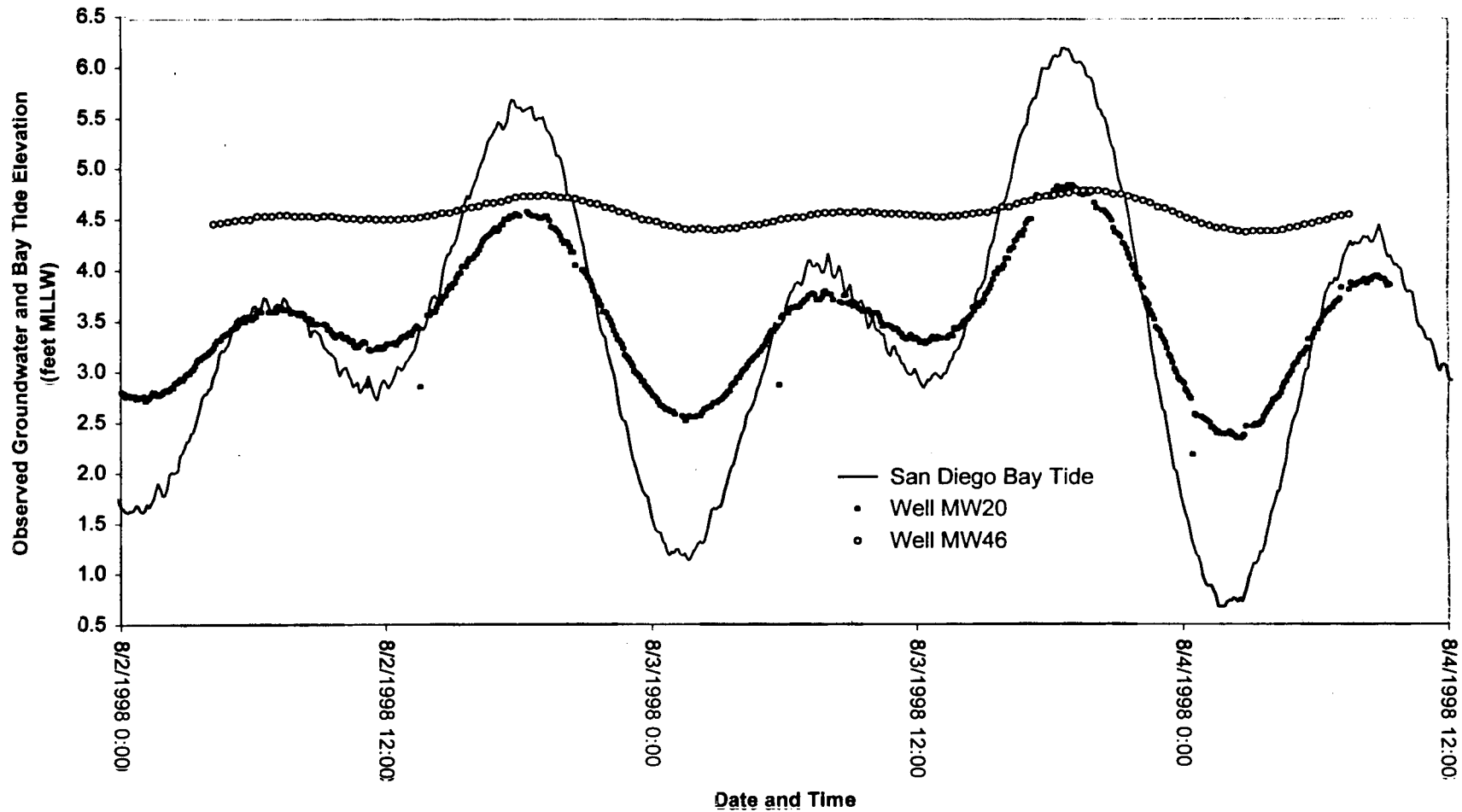

NAS NORTH ISLAND SITE 9
 NoVOCs™ HYDROGEOLOGICAL INVESTIGATION

FIGURE 5-4
 OBSERVED WATER LEVEL COMPARISON
 AMONG
 BAY TIDE, MW20 AND MW46

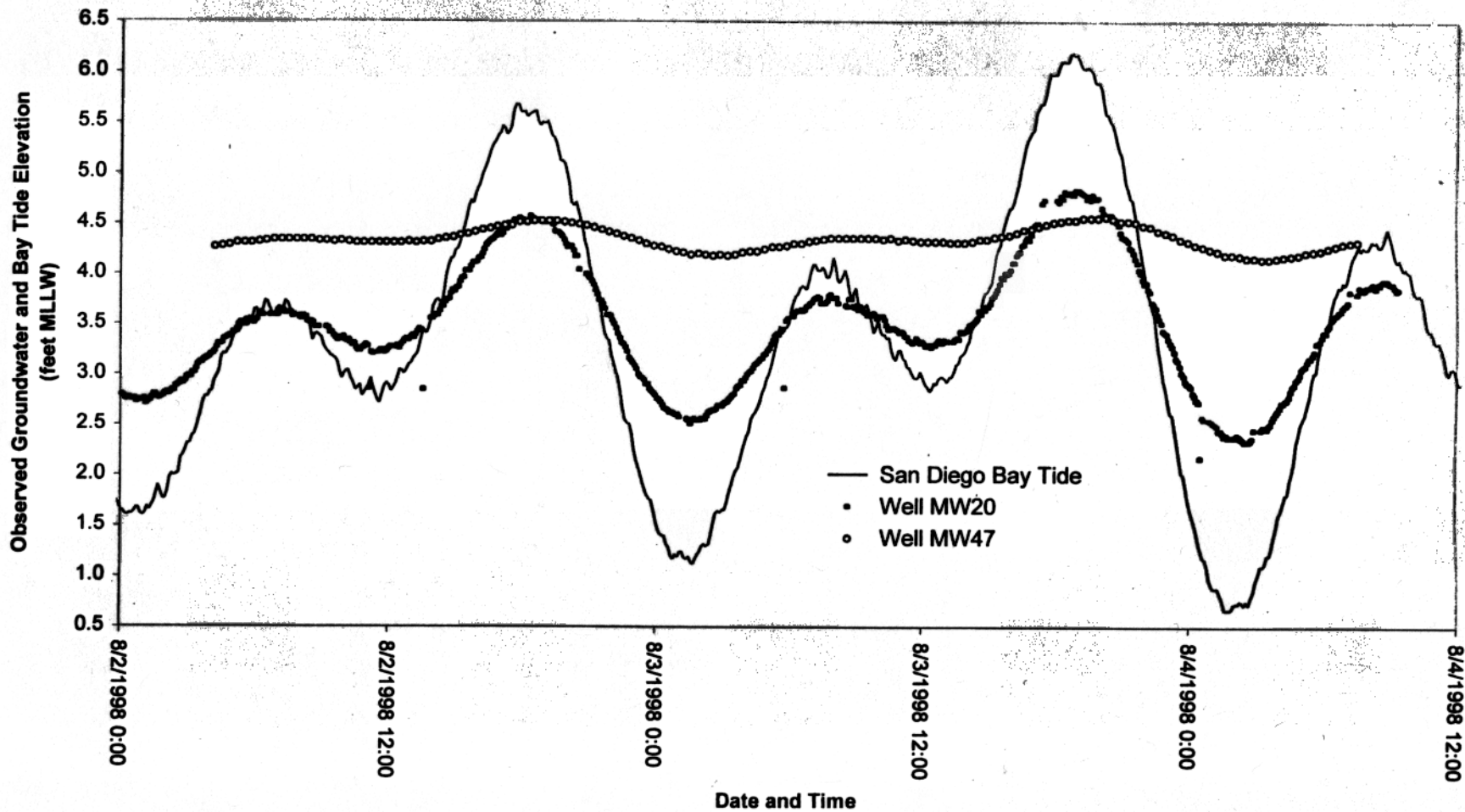

NAS NORTH ISLAND SITE 9
 NoVOCs™ HYDROGEOLOGICAL INVESTIGATION

FIGURE 5-5
 OBSERVED WATER LEVEL COMPARISON
 AMONG
 BAY TIDE, MW20 AND MW47

 Tetra Tech EM Inc.

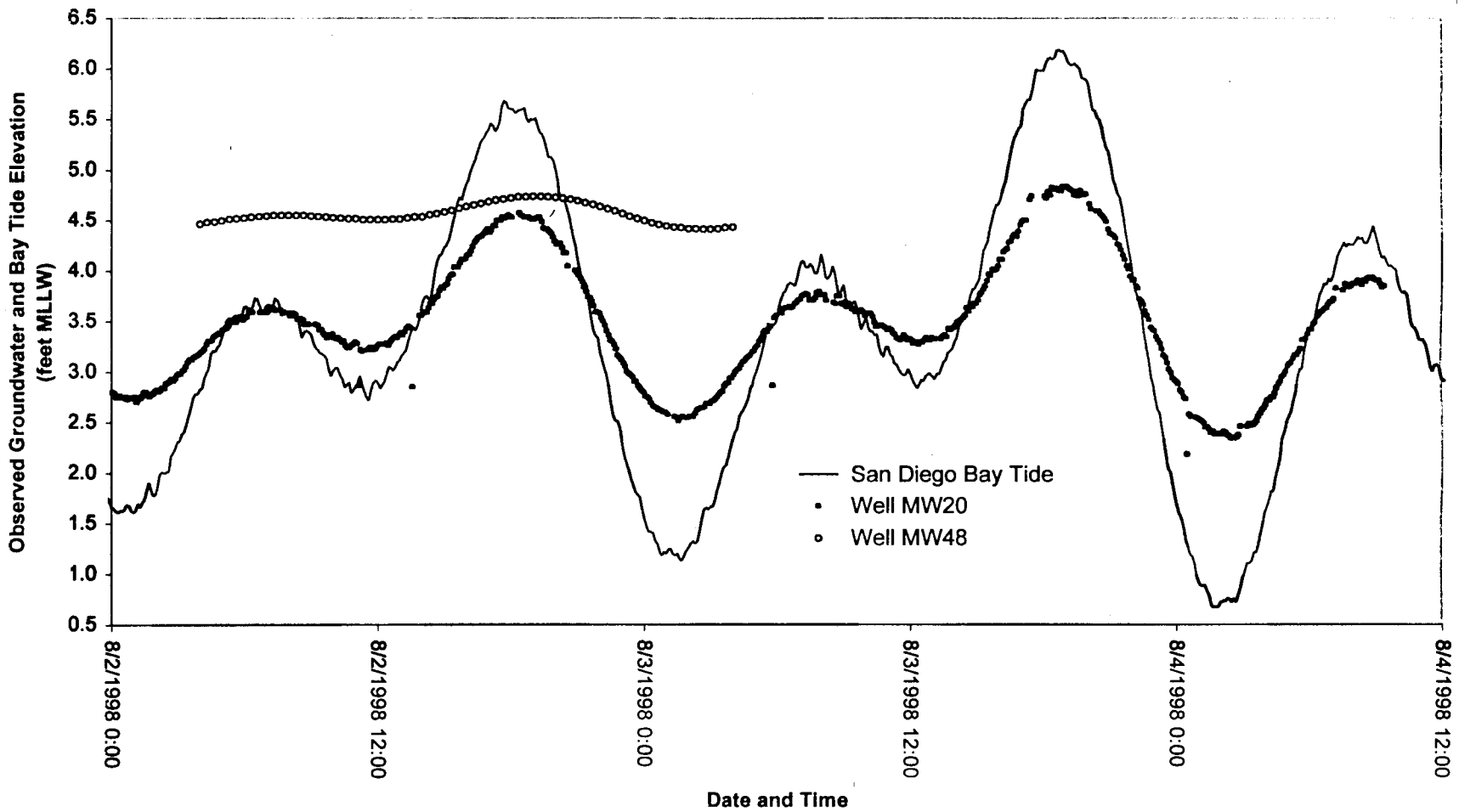

NAS NORTH ISLAND SITE 9
 NoVOCs™ HYDROGEOLOGICAL INVESTIGATION

FIGURE 5-6
 OBSERVED WATER LEVEL COMPARISON
 AMONG
 BAY TIDE, MW20 AND MW48

 Tetra Tech EM Inc.

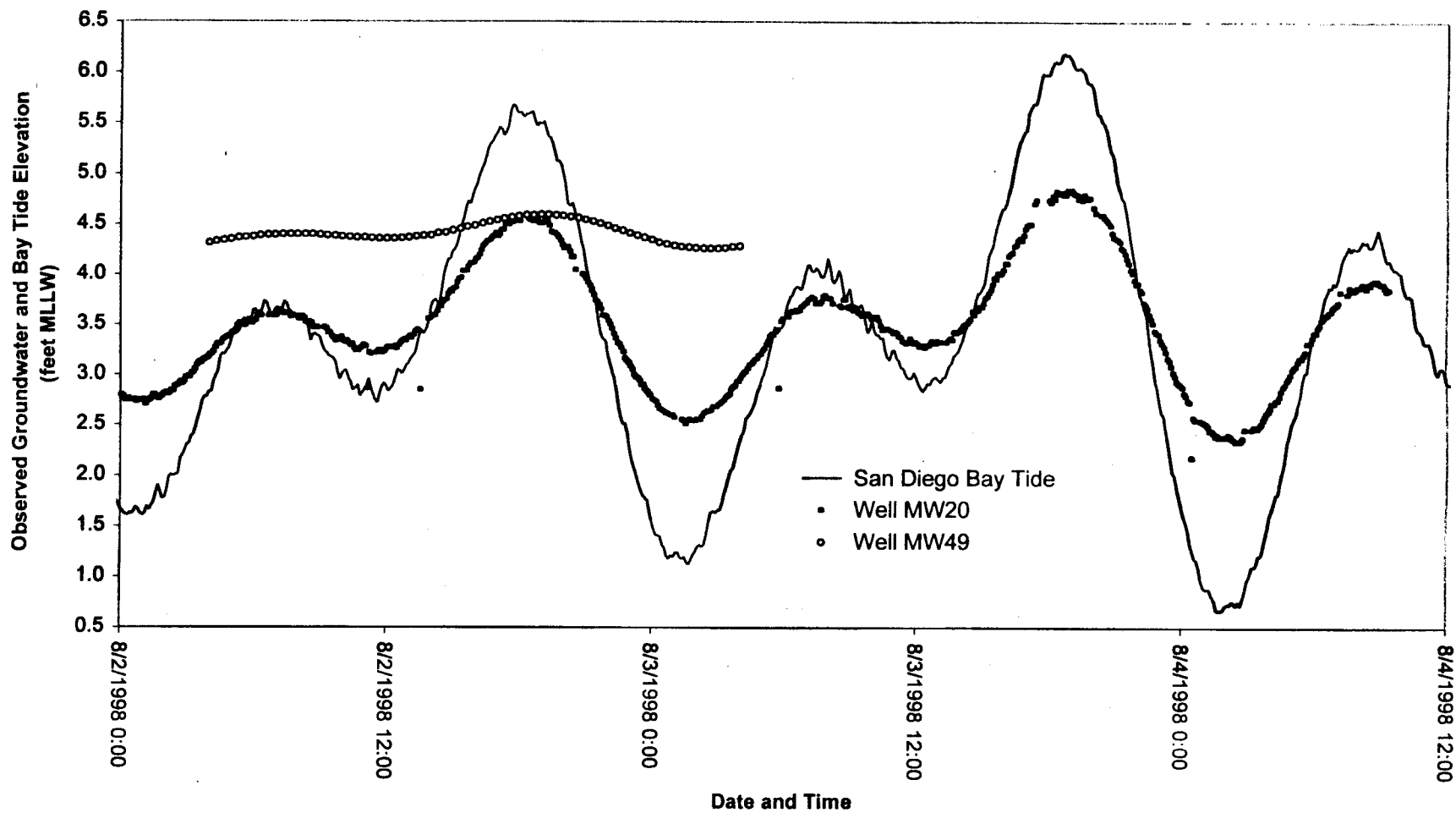

NAS NORTH ISLAND SITE 9
 NoVOCs™ HYDROGEOLOGICAL INVESTIGATION

FIGURE 5-7
 OBSERVED WATER LEVEL COMPARISON
 AMONG
 BAY TIDE, MW20 AND MW49

 Tetra Tech EM Inc.

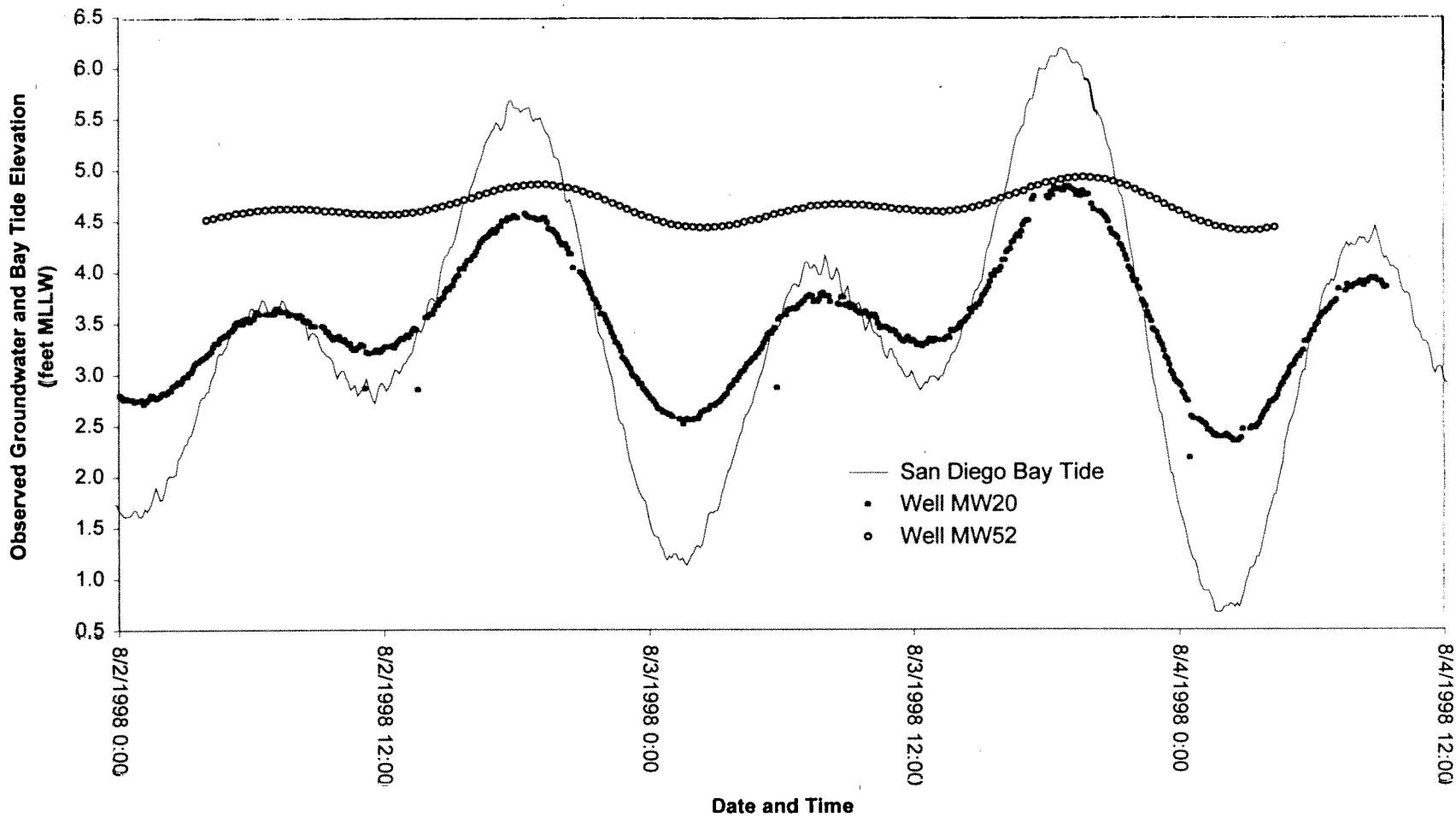

NAS NORTH ISLAND SITE 9
 NoVOCs™ HYDROGEOLOGICAL INVESTIGATION

FIGURE 5-8
 OBSERVED WATER LEVEL COMPARISON
 AMONG
 BAY TIDE, MW20 AND MW52

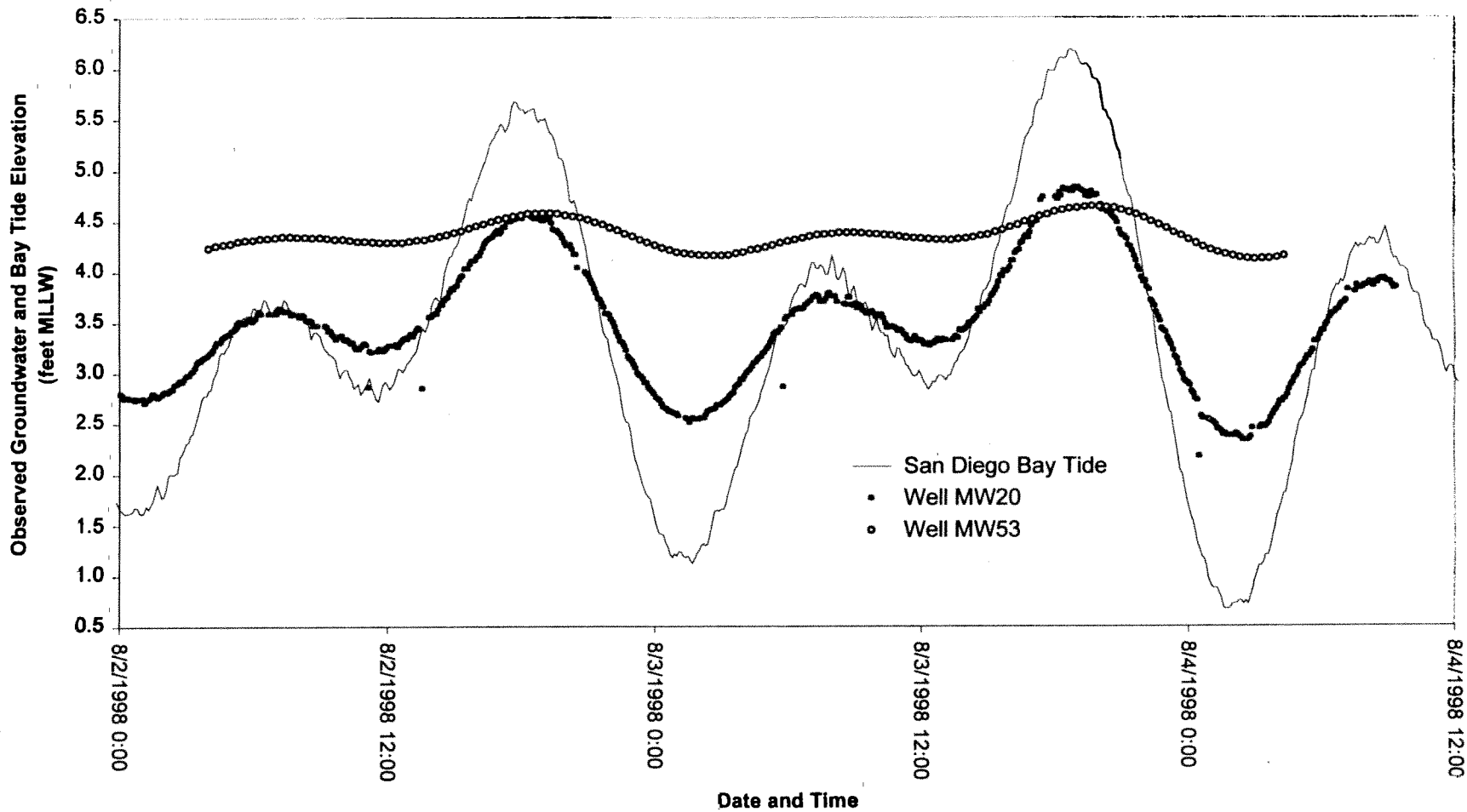

NAS NORTH ISLAND SITE 9
 NoVOCs™ HYDROGEOLOGICAL INVESTIGATION

FIGURE 5-9
 OBSERVED WATER LEVEL COMPARISON
 AMONG
 BAY TIDE, MW20 AND MW53

 Tetra Tech EM Inc.

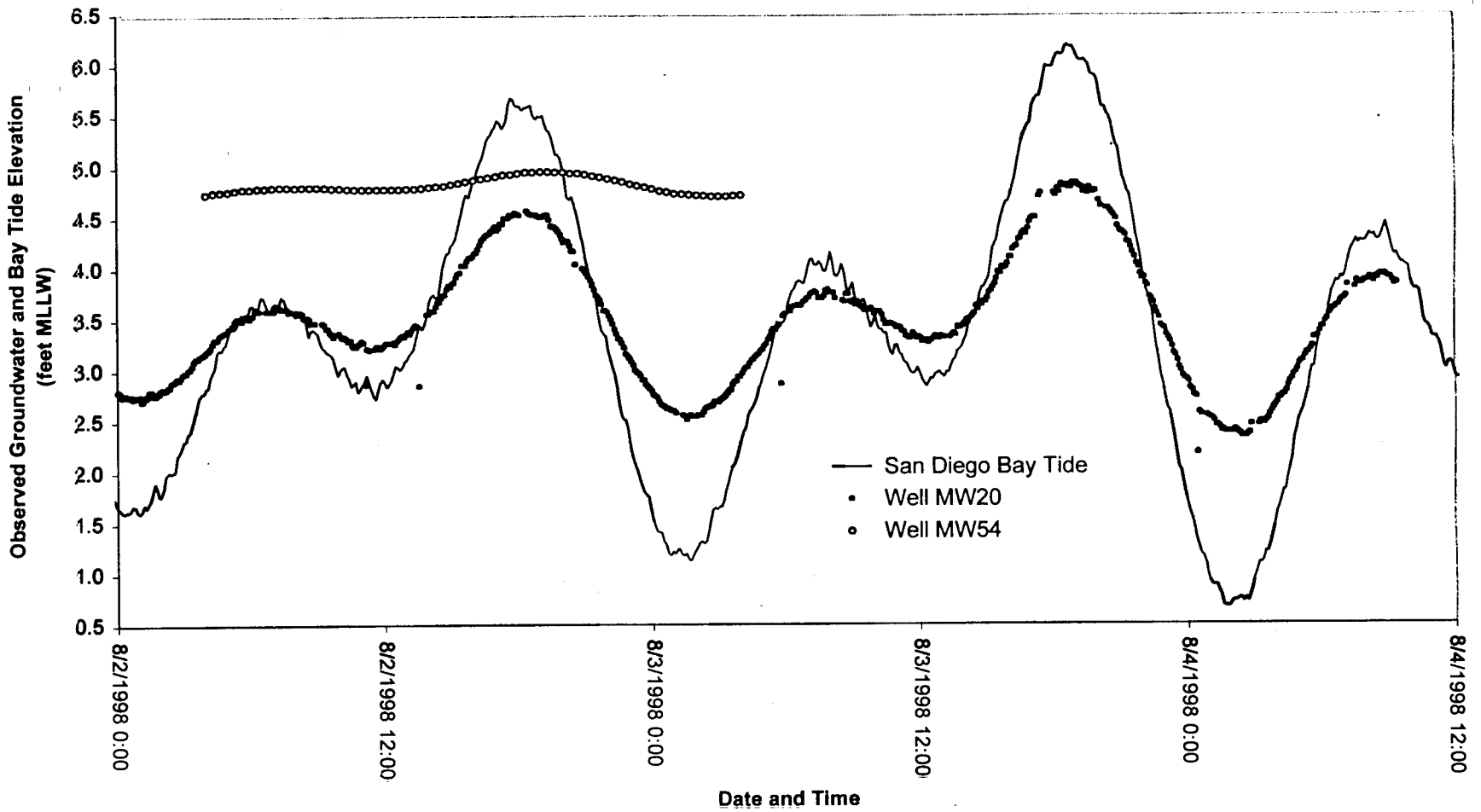

NAS NORTH ISLAND SITE 9
 NoVOCs™ HYDROGEOLOGICAL INVESTIGATION

FIGURE 5-10
 OBSERVED WATER LEVEL COMPARISON
 AMONG
 BAY TIDE, MW20 AND MW54

 Tetra Tech EM Inc.

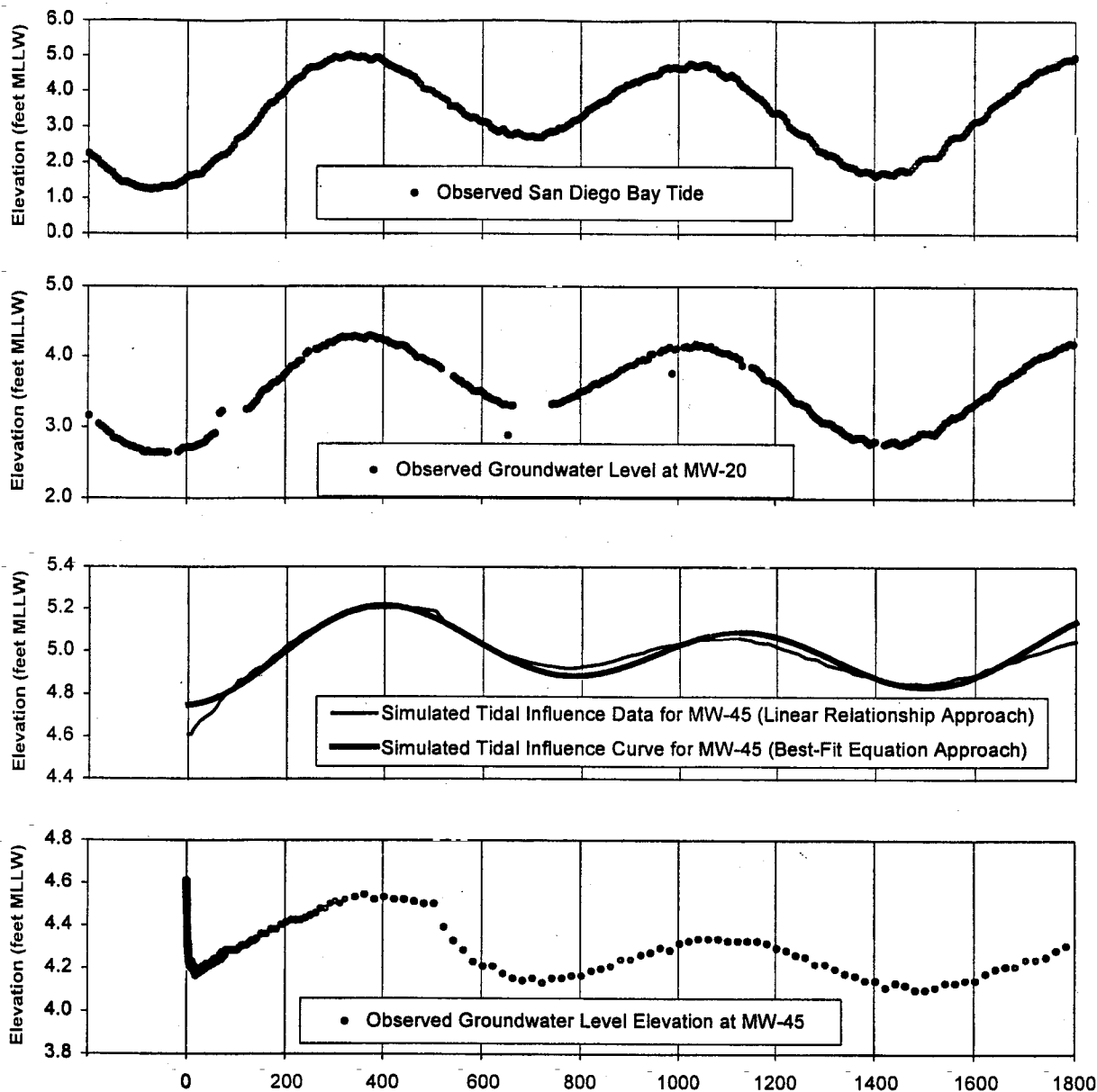

NAS NORTH ISLAND SITE 9
 NoVOCs™ HYDROGEOLOGICAL INVESTIGATION

FIGURE 5-11
 OBSERVED AND SIMULATED WATER LEVEL
 COMPARISON AMONG BAY TIDE, MW20, MW45
 DURING THE PUMPING TEST
 (Upper Aquifer Zone Constant Rate Pumping Test)



Tetra Tech EM Inc.

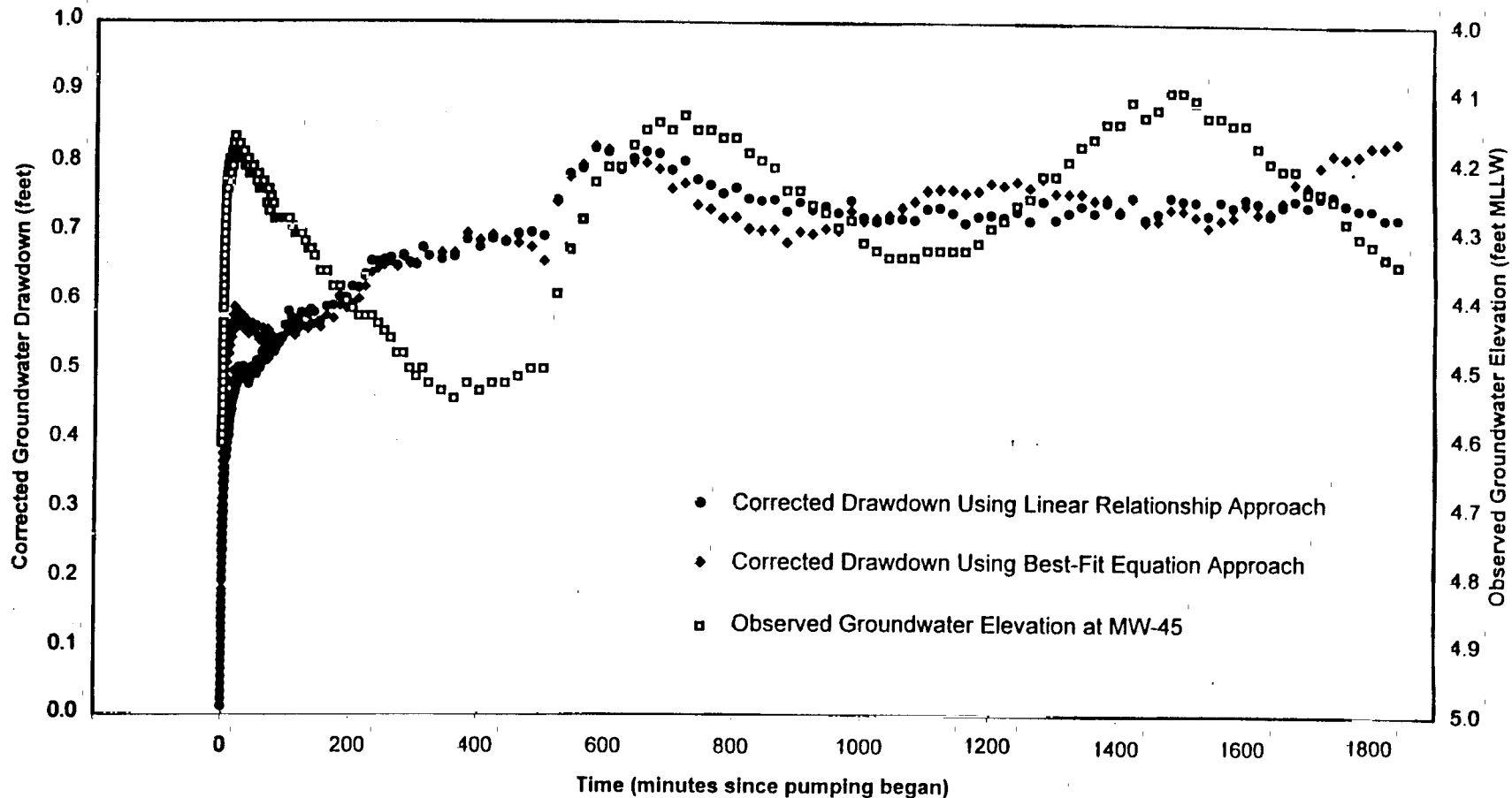

NAS NORTH ISLAND SITE 9
 NoVOCs™ HYDROGEOLOGICAL INVESTIGATION

FIGURE 5-12
 OBSERVED AND CORRECTED GROUNDWATER
 DRAWDOWN AT WELL MW45
 (Upper Aquifer Zone Constant Rate Pumping Test)

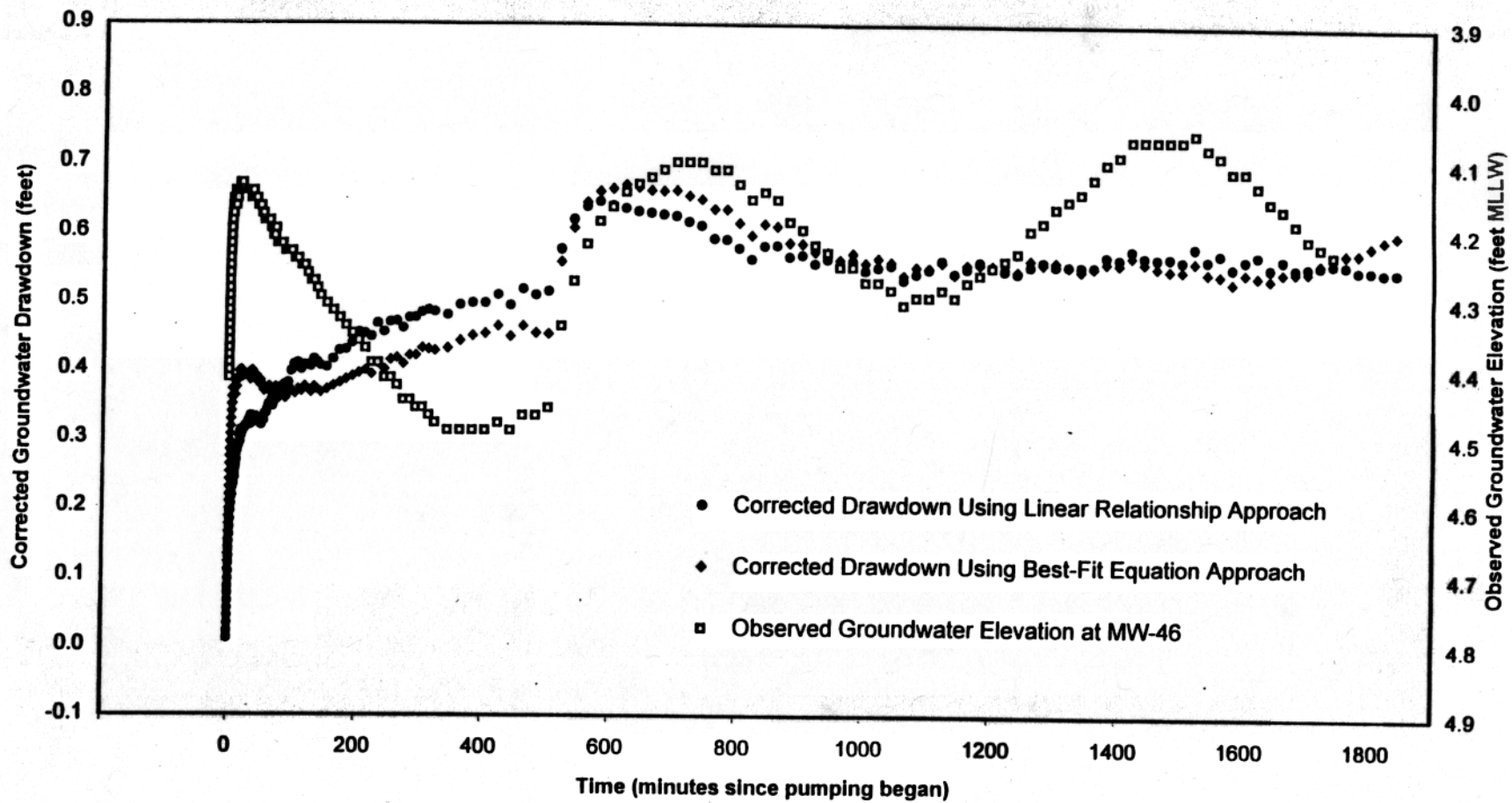

NAS NORTH ISLAND SITE 9
 NoVOCs™ HYDROGEOLOGICAL INVESTIGATION

FIGURE 5-13
 OBSERVED AND CORRECTED GROUNDWATER
 DRAWDOWN AT WELL MW46
 (Upper Aquifer Zone Constant Rate Pumping Test)

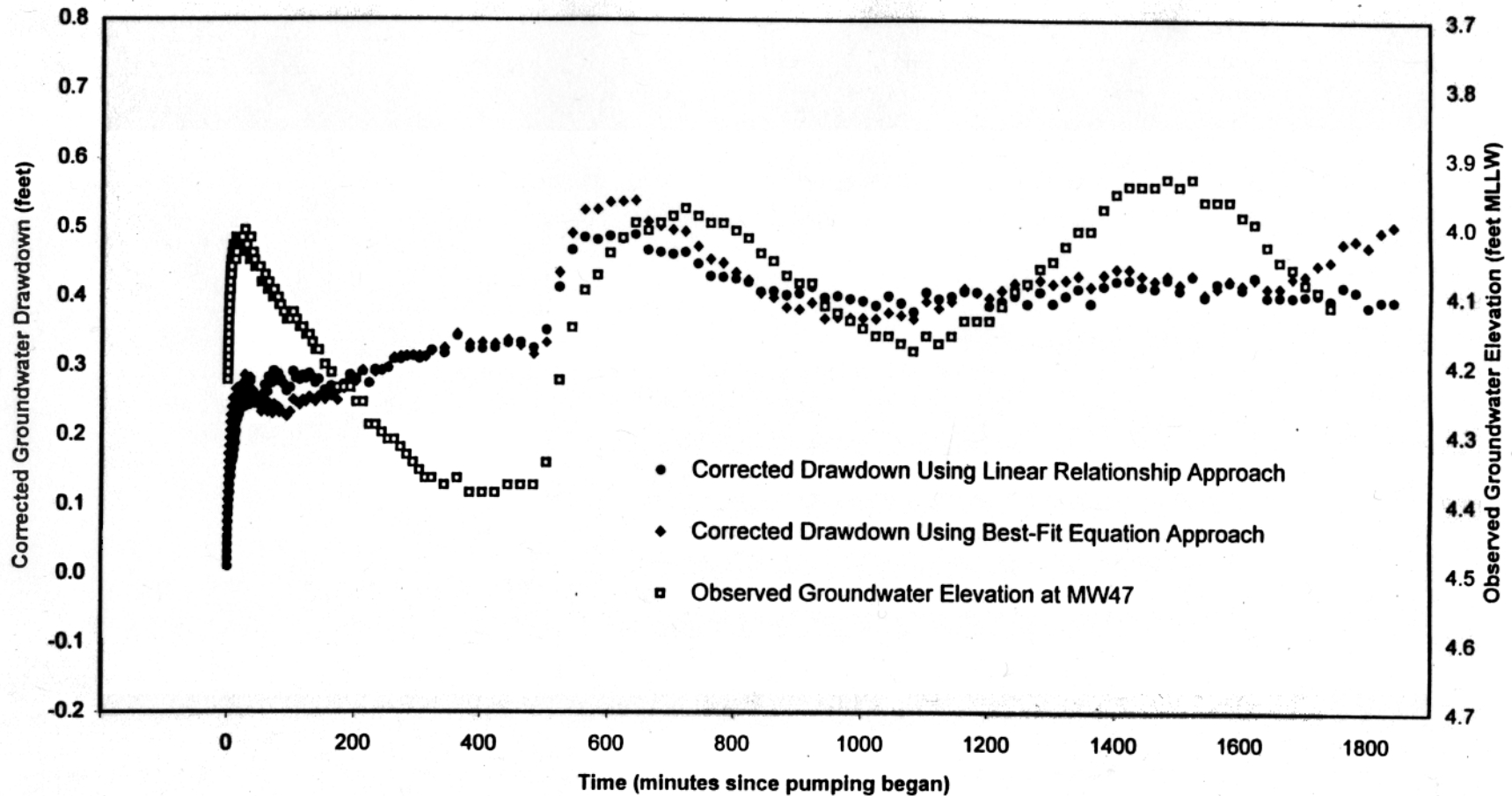

NAS NORTH ISLAND SITE 9
 NoVOCs™ HYDROGEOLOGICAL INVESTIGATION

FIGURE 5-14
 OBSERVED AND CORRECTED GROUNDWATER
 DRAWDOWN AT WELL MW47
 (Upper Aquifer Zone Constant Rate Pumping Test)

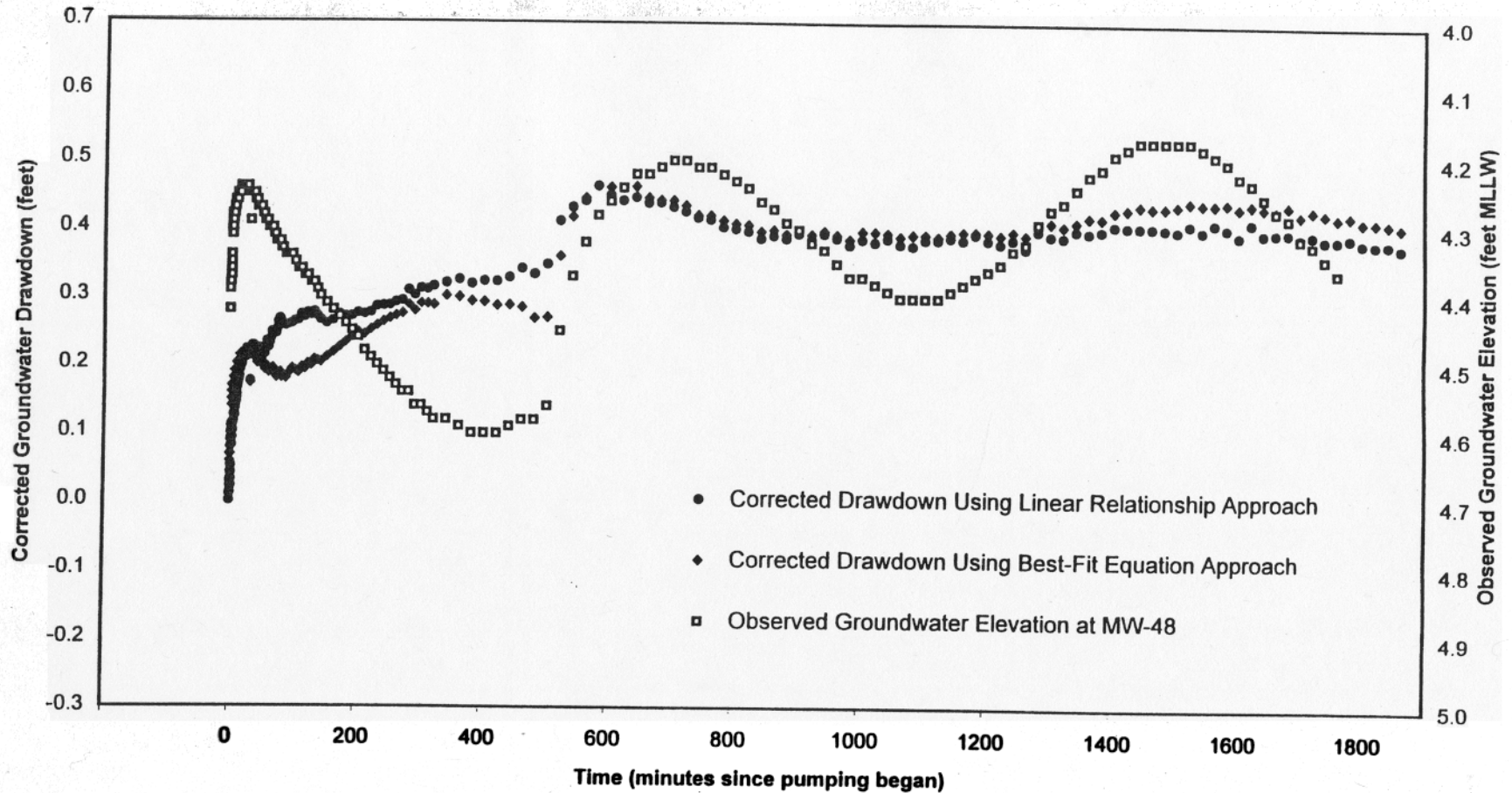

NAS NORTH ISLAND SITE 9
 NoVOCs™ HYDROGEOLOGICAL INVESTIGATION

FIGURE 5-15
 OBSERVED AND CORRECTED GROUNDWATER
 DRAWDOWN AT WELL MW48
 (Upper Aquifer Zone Constant Rate Pumping Test)

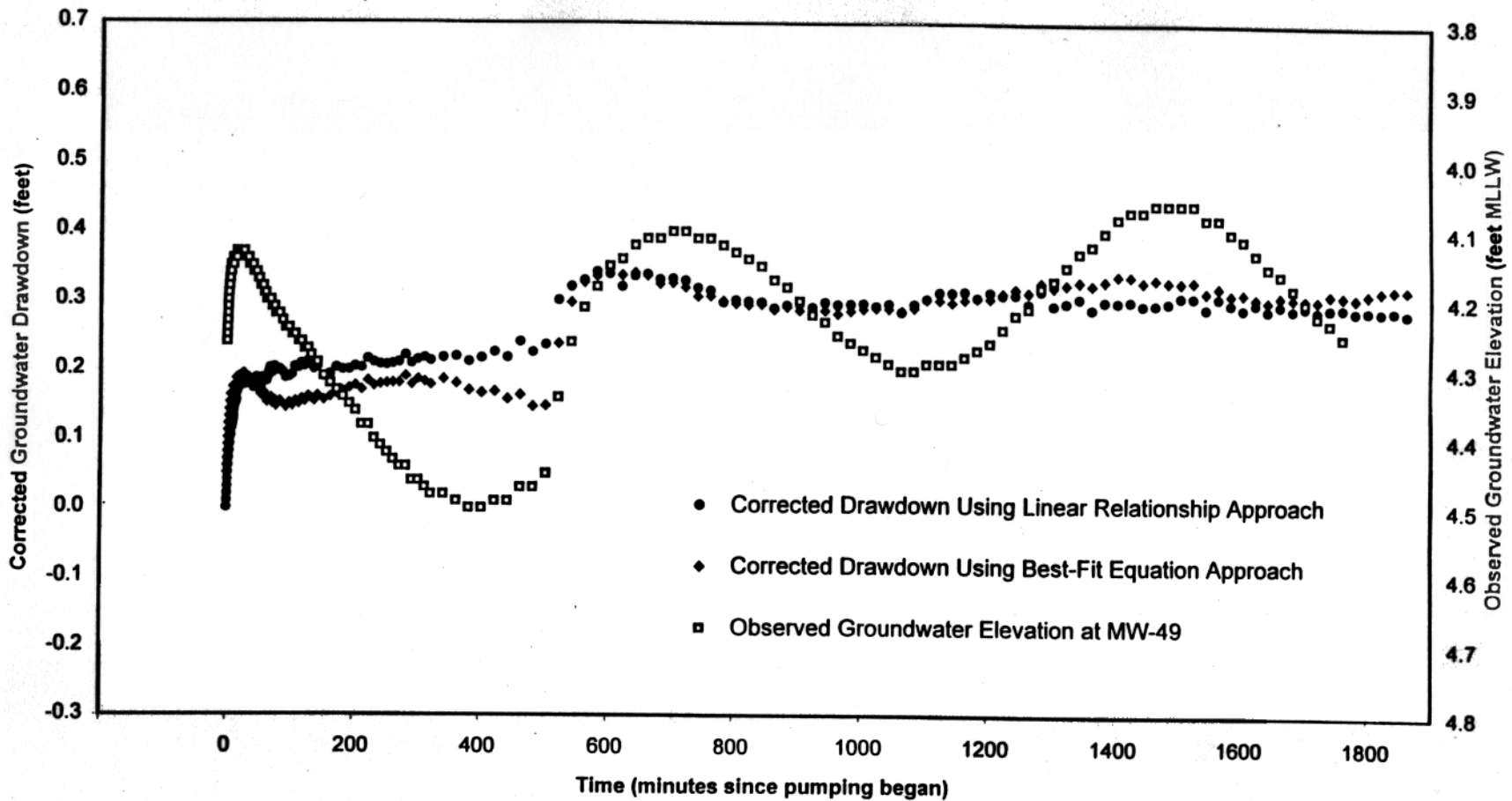

NAS NORTH ISLAND SITE 9
 NoVOCs™ HYDROGEOLOGICAL INVESTIGATION

FIGURE 5-16
 OBSERVED AND CORRECTED GROUNDWATER
 DRAWDOWN AT WELL MW49
 (Upper Aquifer Zone Constant Rate Pumping Test)

 Tetra Tech EM Inc.

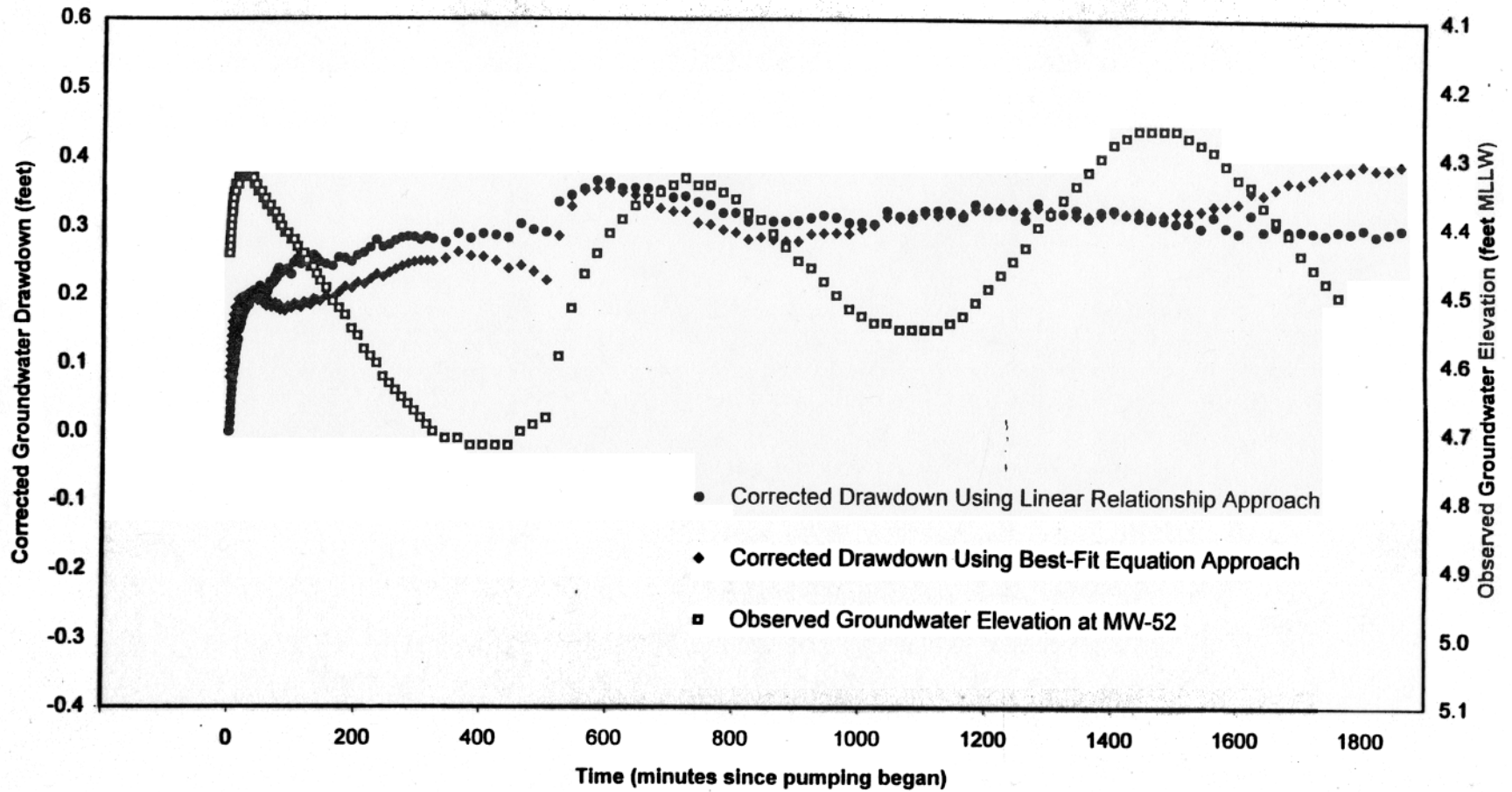

NAS NORTH ISLAND SITE 9
 NoVOCs™ HYDROGEOLOGICAL INVESTIGATION

FIGURE 5-17
 OBSERVED AND CORRECTED GROUNDWATER
 DRAWDOWN AT WELL MW52
 (Upper Aquifer Zone Constant Rate Pumping Test)

 Tetra Tech EM Inc.

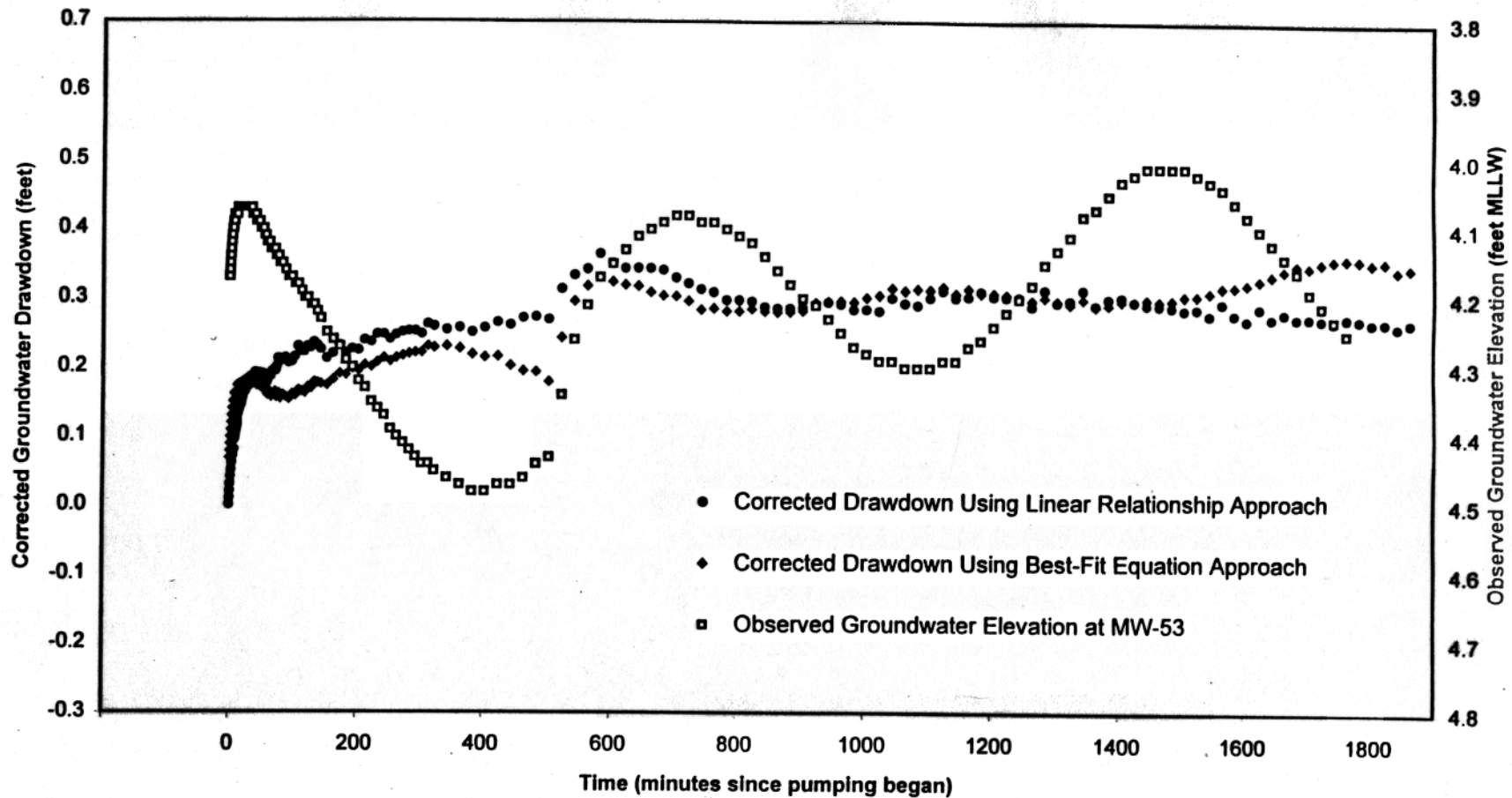

NAS NORTH ISLAND SITE 9
 NoVOCs™ HYDROGEOLOGICAL INVESTIGATION

FIGURE 5-18
 OBSERVED AND CORRECTED GROUNDWATER
 DRAWDOWN AT WELL MW53
 (Upper Aquifer Zone Constant Rate Pumping Test)

 Tetra Tech EM Inc.

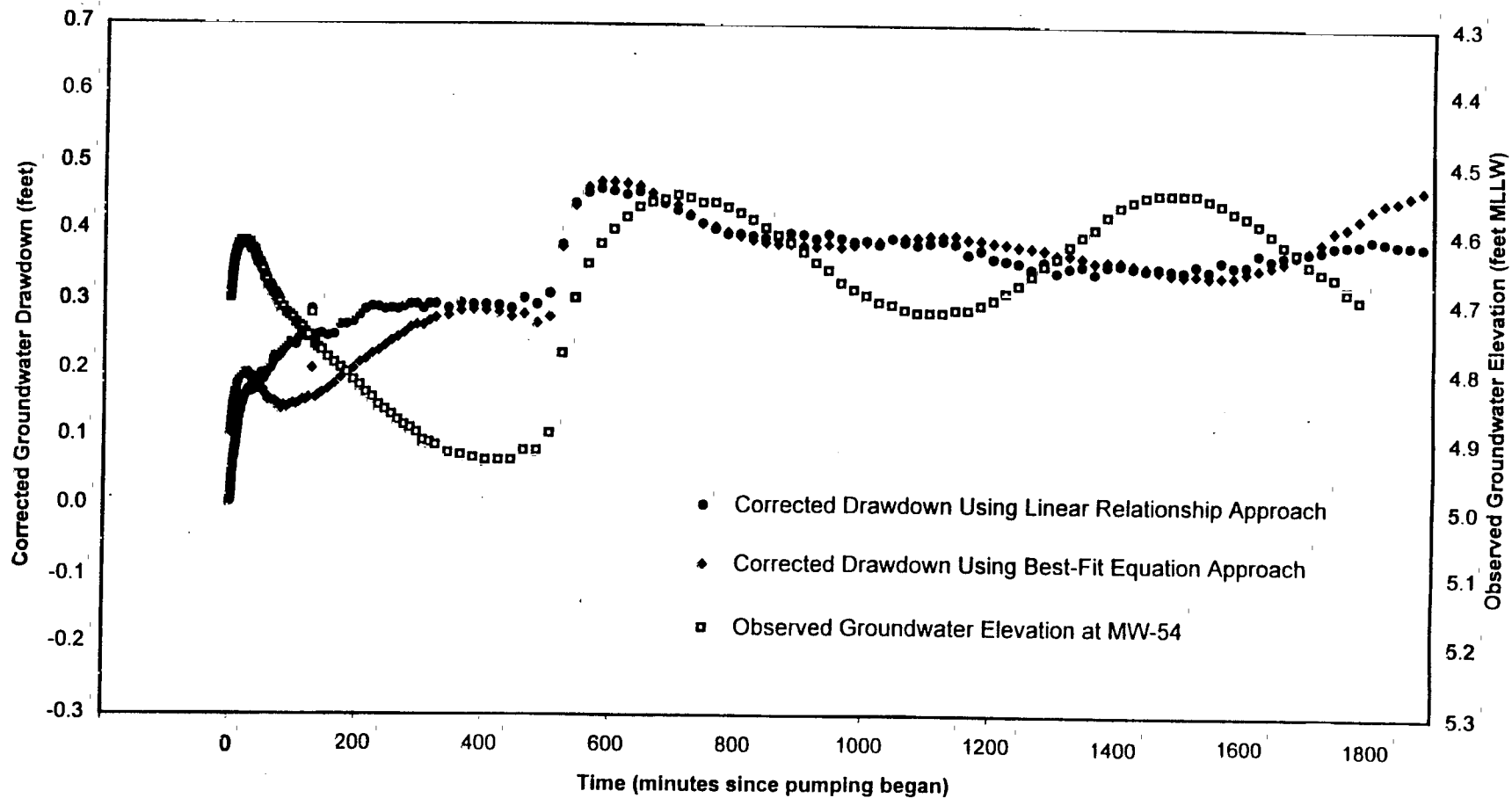

NAS NORTH ISLAND SITE 9
 NoVOCs™ HYDROGEOLOGICAL INVESTIGATION

FIGURE 5-19
 OBSERVED AND CORRECTED GROUNDWATER
 DRAWDOWN AT WELL MW54
 (Upper Aquifer Zone Constant Rate Pumping Test)

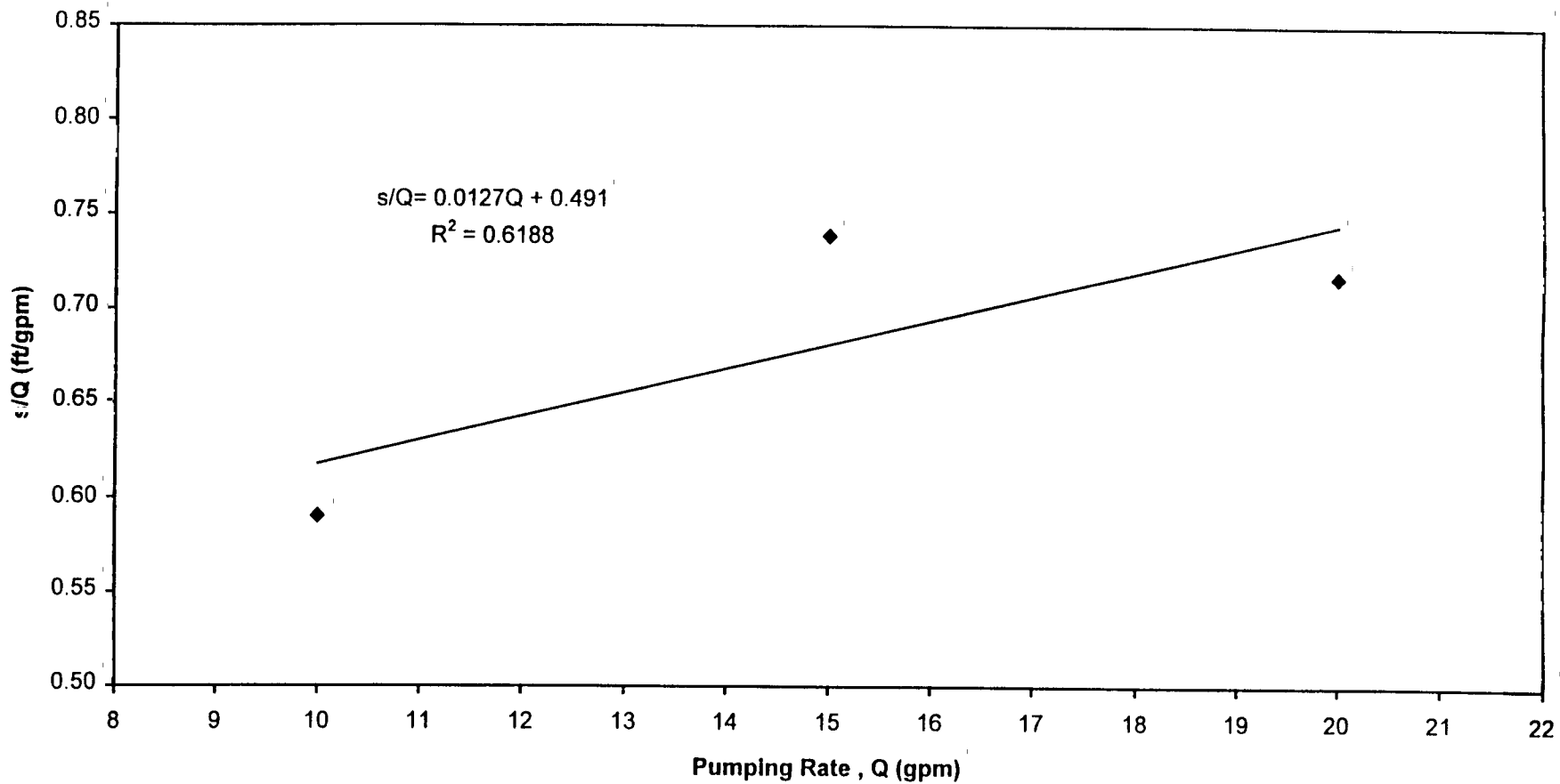

NAS NORTH ISLAND SITE 9
NoVOCs™ HYDROGEOLOGICAL INVESTIGATION

FIGURE 5-20
s/Q vs. Q PLOTS

(Upper Aquifer Zone Step-drawdown Test)

 Tetra Tech EM Inc.

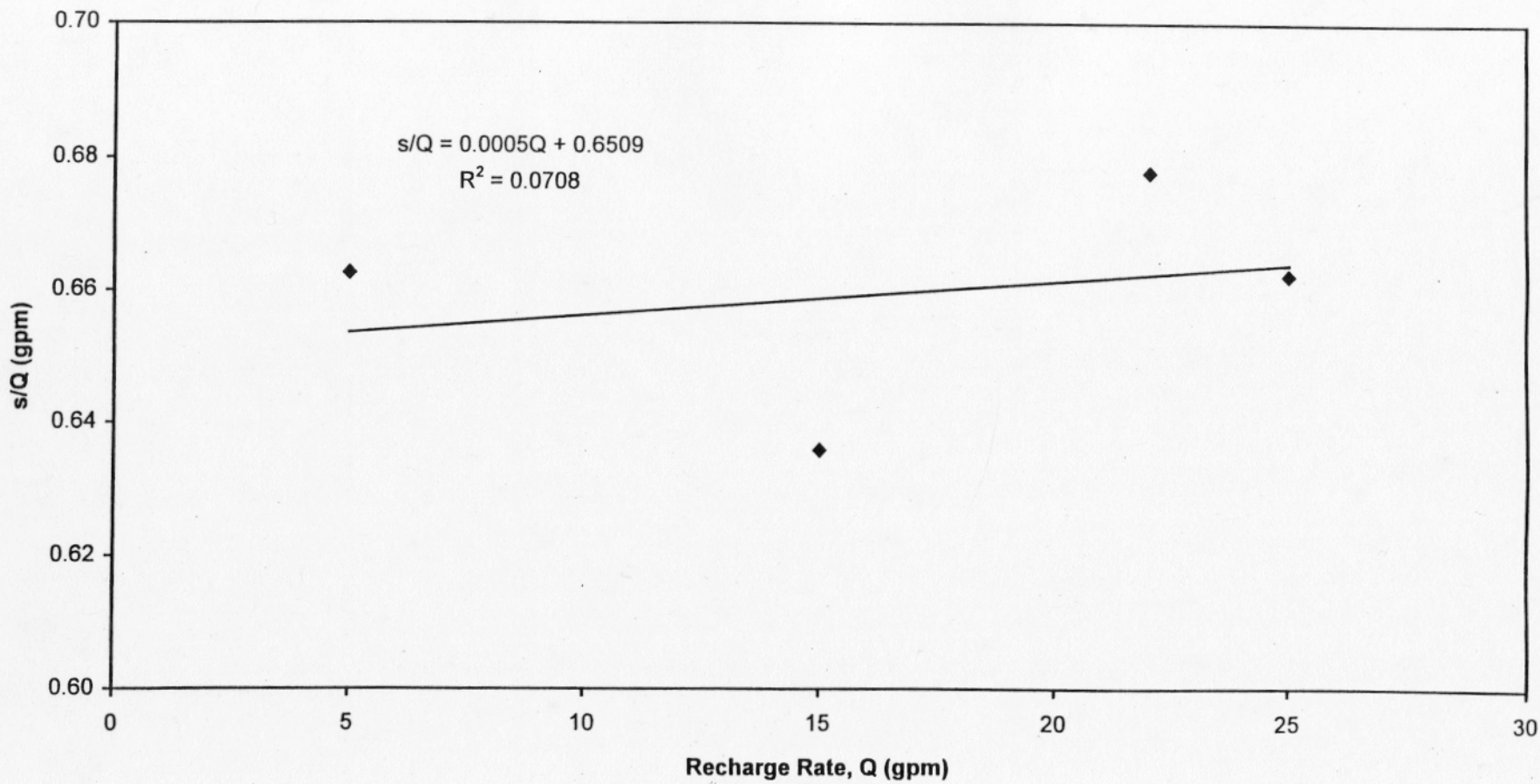

NAS NORTH ISLAND SITE 9
 NoVOCs™ HYDROGEOLOGICAL INVESTIGATION

FIGURE 5-21
 s/Q vs. Q PLOTS

(Upper Aquifer Zone Injection Test)

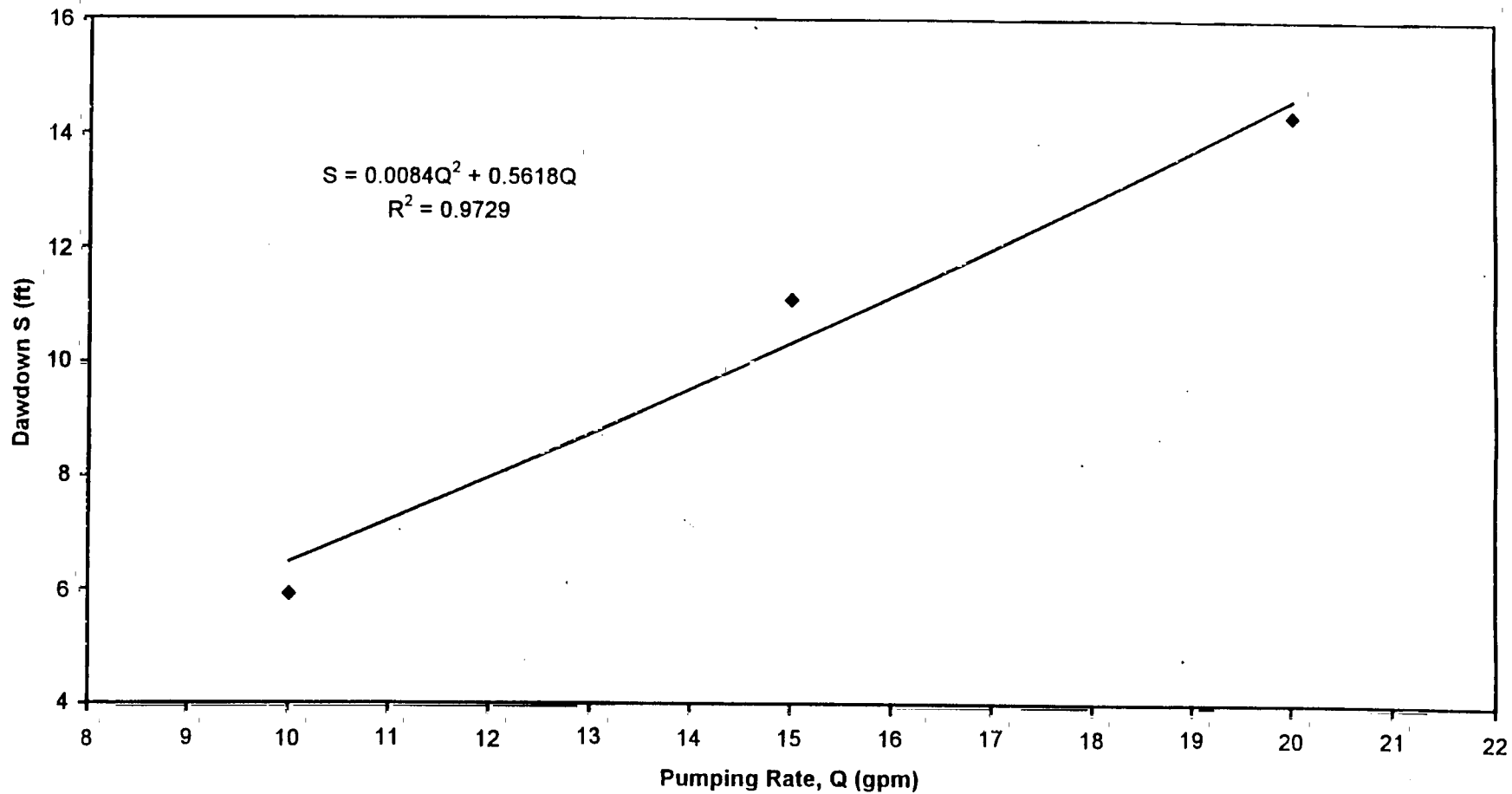

NAS NORTH ISLAND SITE 9
 NoVOCs™ HYDROGEOLOGICAL INVESTIGATION

FIGURE 5-22
 MAXIMUM DRAWDOWN vs. PUMPING RATE AND
 THE BEST FIT EQUATION
 (Upper Aquifer Zone Step-drawdown Test)

 Tetra Tech EM Inc.

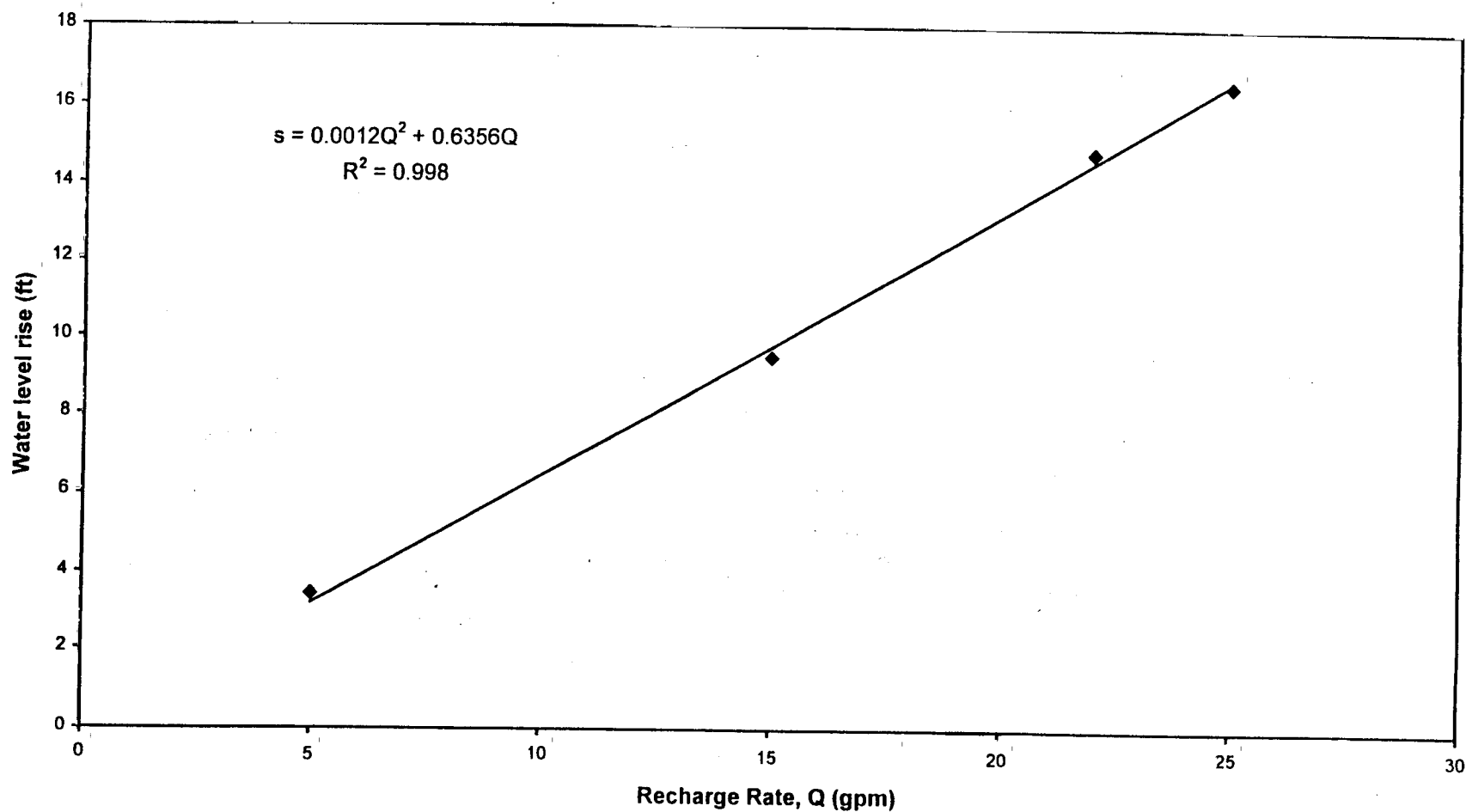

NAS NORTH ISLAND SITE 9
NoVOCs™ HYDROGEOLOGICAL INVESTIGATION

FIGURE 5-23
MAXIMUM WATER LEVEL RISE vs. RECHARGE
RATE AND THE BEST FIT EQUATION
(Upper Aquifer Zone Injection Test)

 Tetra Tech EM Inc.

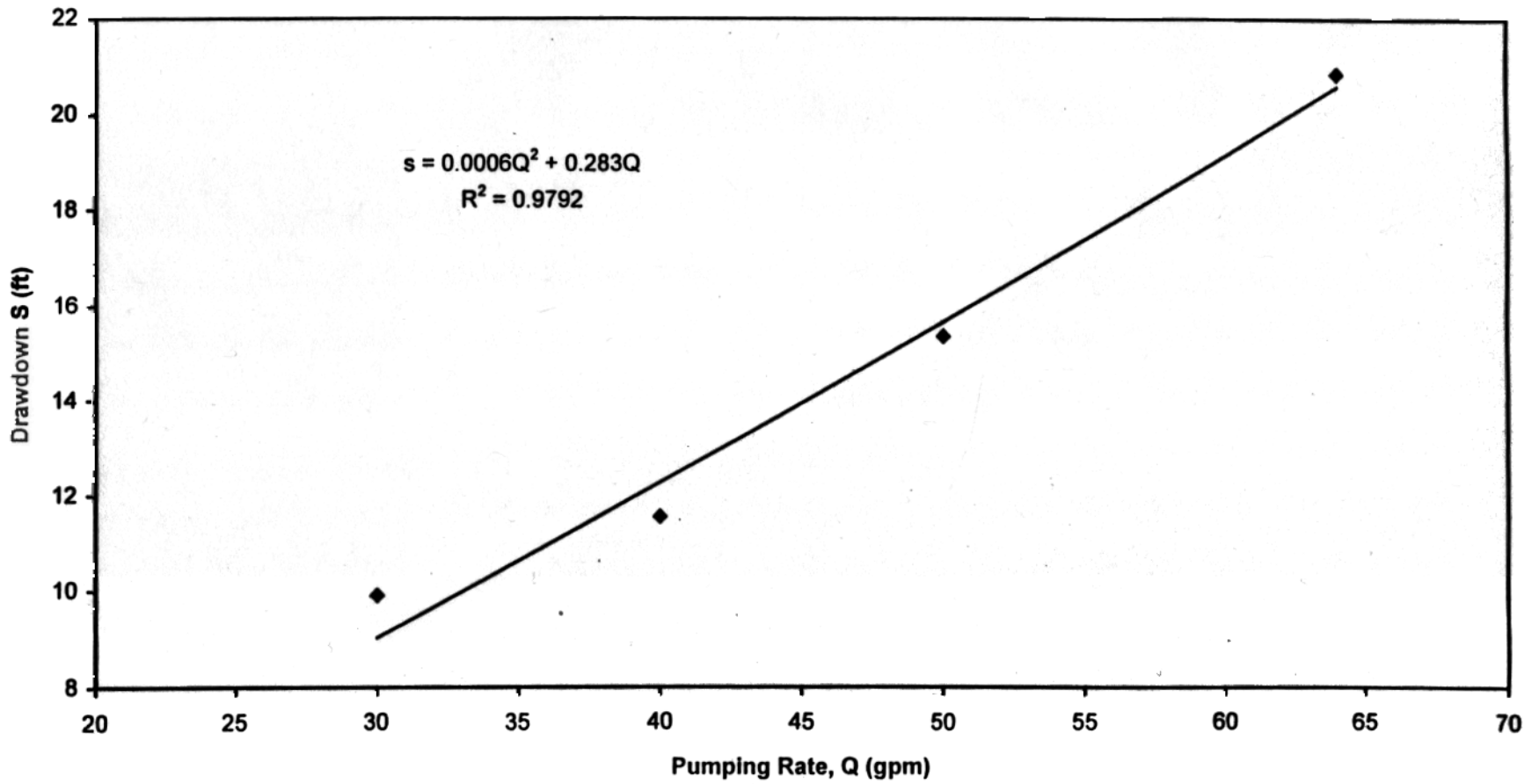

NAS NORTH ISLAND SITE 9
NoVOCs™ HYDROGEOLOGICAL INVESTIGATION

FIGURE 5-24
MAXIMUM DRAWDOWN vs. PUMPING RATE AND
THE BEST FIT EQUATION
(Lower Aquifer Zone Step-drawdown Test)

 Tetra Tech EM Inc.

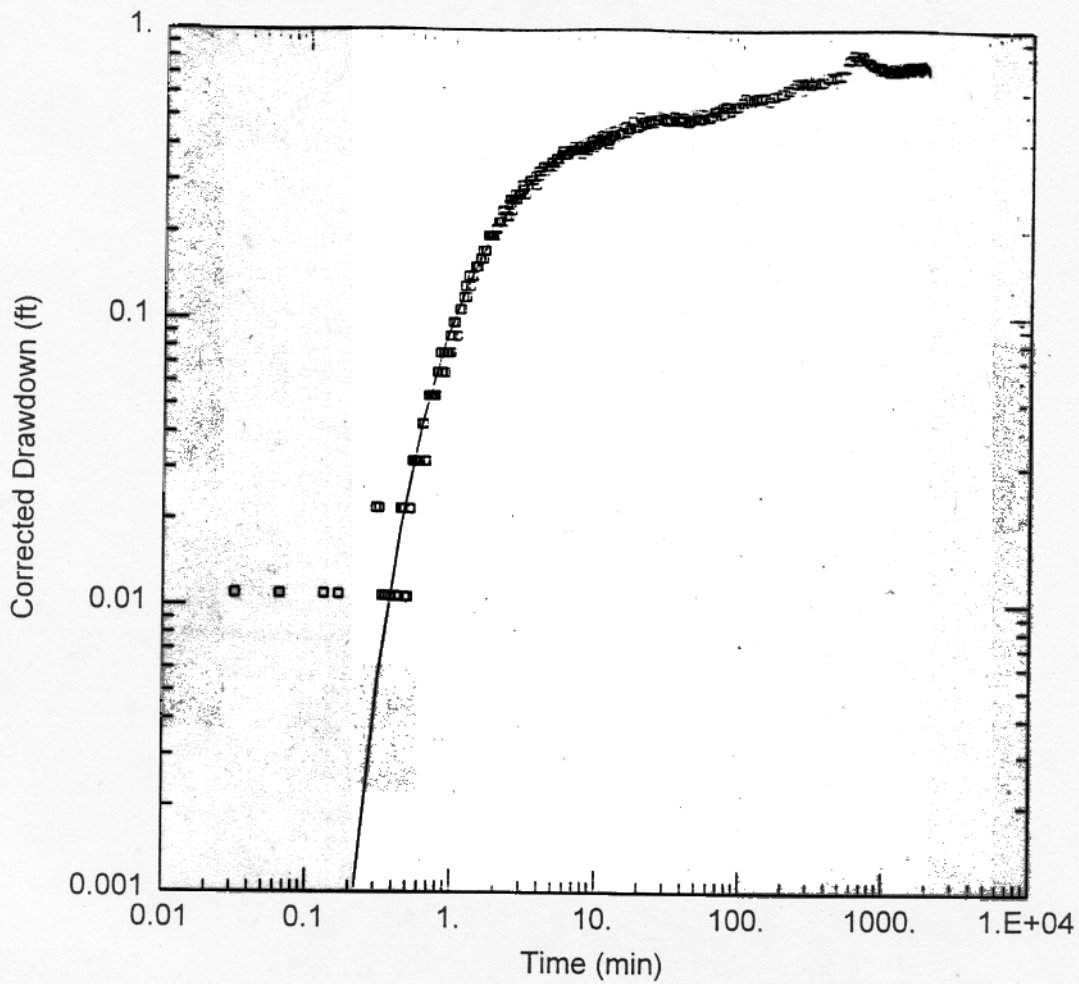

NAS NI SITE 9 PUMPING TEST DATA - MW45

Data Set: S:\NOVOCs\WORKIN~2\CONSTA~2\MW45-88.AQT

Date: 02/12/99

Time: 17:47:28

SOLUTION

Aquifer Model: Unconfined

Solution Method: Neuman

$T = 2450. \text{ ft}^2/\text{day}$

$S = 0.008428$

$Sy = 0.1201$

$\beta = 0.03$

NAS NORTH ISLAND SITE 9
NoVOCs™ HYDROGEOLOGICAL INVESTIGATION

FIGURE 5-25
MW45 DRAWDOWN DATA PLOT
AND TYPE CURVE MATCH
(Upper Aquifer Zone Constant Rate Pumping Test)



Tetra Tech EM Inc.

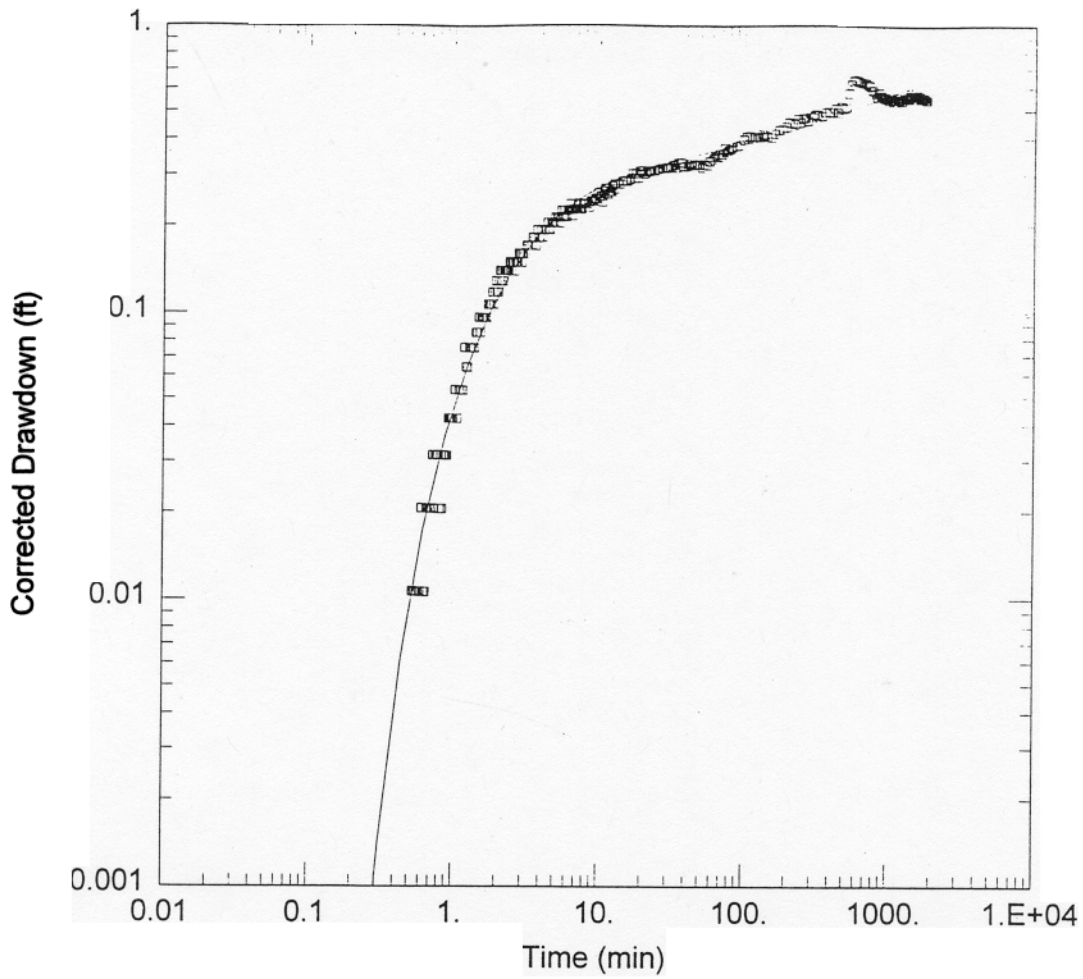

NAS NI SITE 9 PUMPING TEST DATA - MW46

Data Set: S:\NOVOCs\WORKIN~2\CONSTA~2\MW46-88.AQT

Date: 02/12/99

Time: 17:25:35

SOLUTION

Aquifer Model: Unconfined

Solution Method: Neuman

$T = 2722.3 \text{ ft}^2/\text{day}$

$S = 0.007299$

$S_y = 0.05222$

$\beta = 0.03$

**NAS NORTH ISLAND SITE 9
NoVOCs™ HYDROGEOLOGICAL INVESTIGATION**

**FIGURE 5-26
MW46 DRAWDOWN DATA PLOT
AND TYPE CURVE MATCH
(Upper Aquifer Zone Constant Rate Pumping Test)**



Tetra Tech EM Inc.

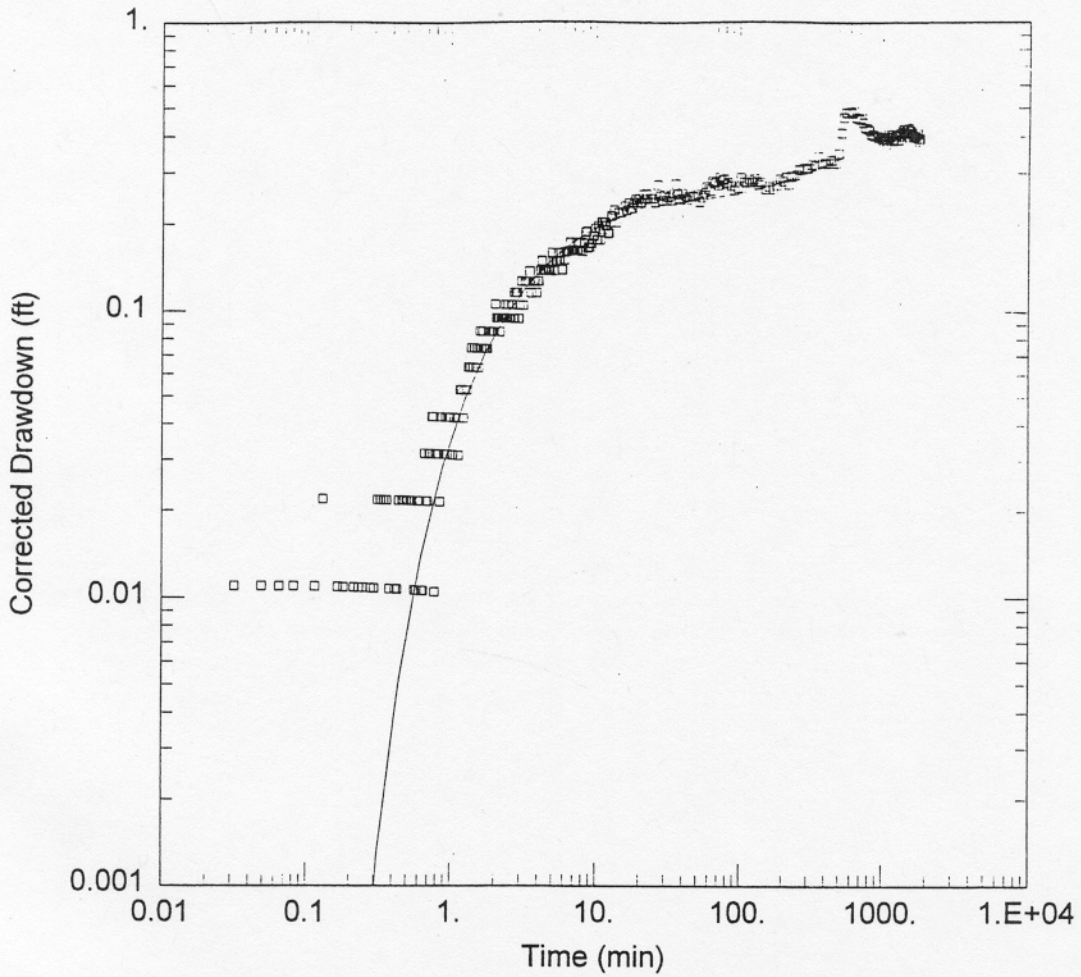

NAS NI SITE 9 PUMPING TEST DATA - MW-47

Data Set: S:\NOVOCSSWORKIN~2\CONSTA~2\MW47-88.AQT

Date: 02/12/99

Time: 17:25:47

SOLUTION

Aquifer Model: Unconfined

Solution Method: Neuman

$T = 2441.4 \text{ ft}^2/\text{day}$

$S = 0.001919$

$S_y = 0.05972$

$\beta = 0.03$

NAS NORTH ISLAND SITE 9
NoVOCs™ HYDROGEOLOGICAL INVESTIGATION

FIGURE 5-27
MW47 DRAWDOWN DATA PLOT
AND TYPE CURVE MATCH
(Upper Aquifer Zone Constant Rate Pumping Test)



Tetra Tech EM Inc.

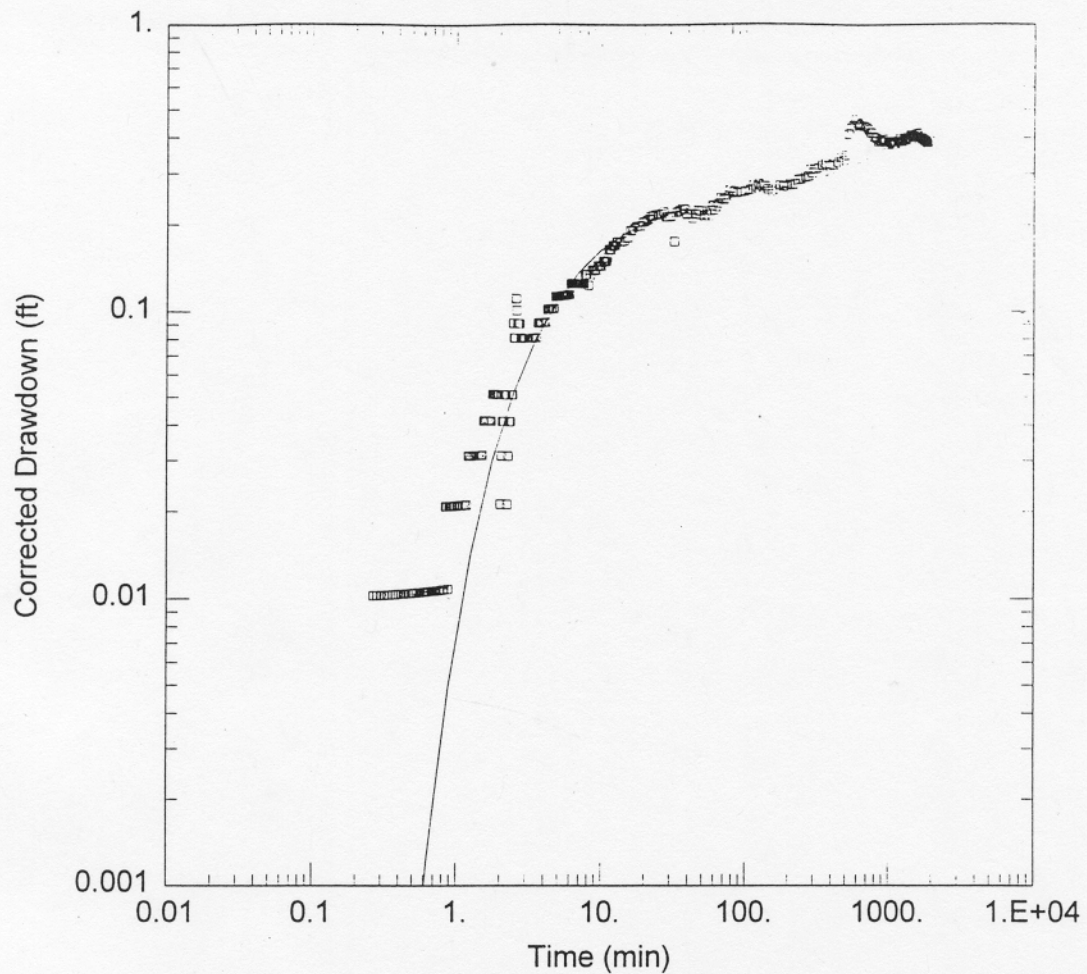

NAS NI SITE 9 PUMPING TEST DATA - MW48

Data Set: S:\NOVOC\WORKIN~2\CONSTA~2\MW48-88.AQT

Date: 02/12/99

Time: 17:25:57

SOLUTION

Aquifer Model: Unconfined

Solution Method: Neuman

T = 2553. ft²/day

S = 0.004492

Sy = 0.08931

β = 0.09

NAS NORTH ISLAND SITE 9
NoVOCs™ HYDROGEOLOGICAL INVESTIGATION

FIGURE 5-28
MW48 DRAWDOWN DATA PLOT
AND TYPE CURVE MATCH
(Upper Aquifer Zone Constant Rate Pumping Test)



Tetra Tech EM Inc.

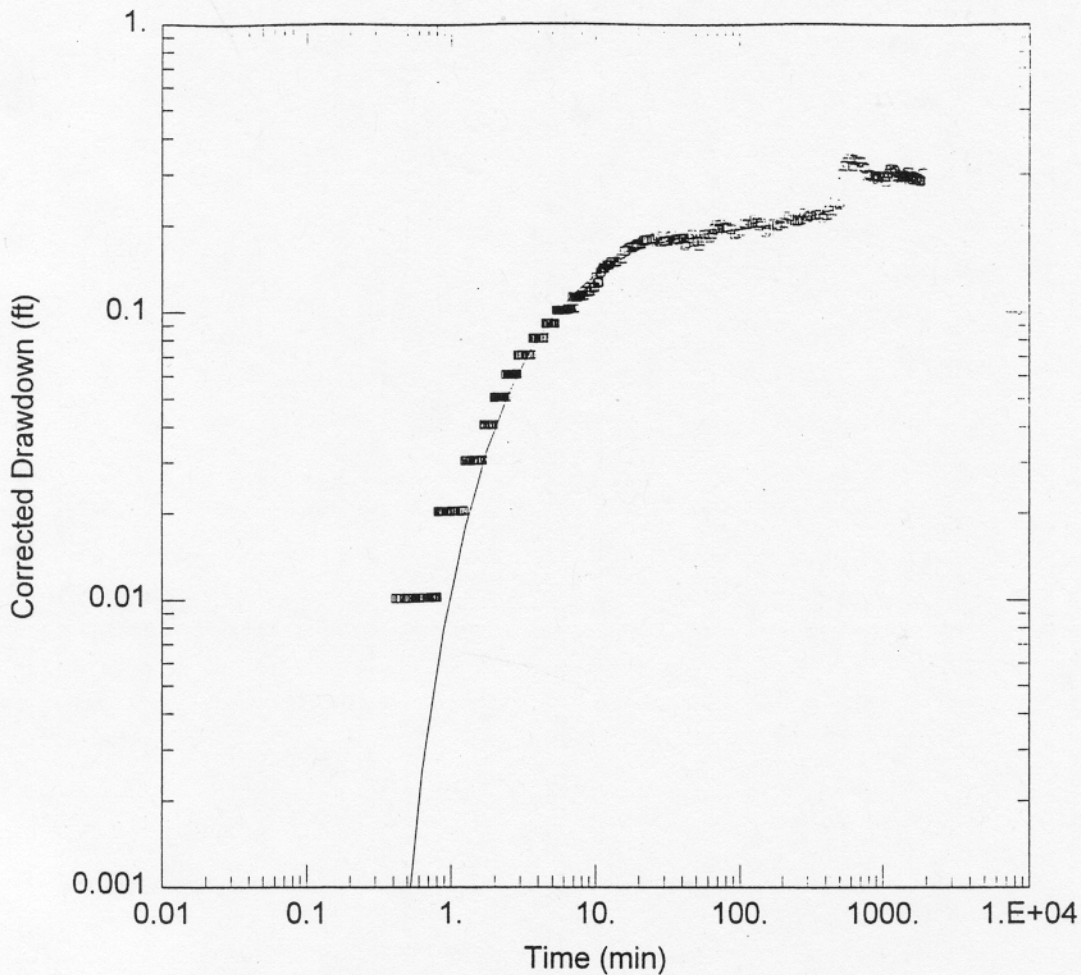

NAS NI SITE 9 PUMPING TEST DATA - MW49

Data Set: S:\NOVOCS\WORKIN~2\CONSTA~2\MW49-88.AQT

Date: 02/12/99

Time: 17:26:08

SOLUTION

Aquifer Model: Unconfined

Solution Method: Neuman

$T = 2774. \text{ ft}^2/\text{day}$

$S = 0.002236$

$S_y = 0.1075$

$\beta = 0.08$

NAS NORTH ISLAND SITE 9
NoVOCs™ HYDROGEOLOGICAL INVESTIGATION

FIGURE 5-29
MW49 DRAWDOWN DATA PLOT
AND TYPE CURVE MATCH
(Upper Aquifer Zone Constant Rate Pumping Test)



Tetra Tech EM Inc.

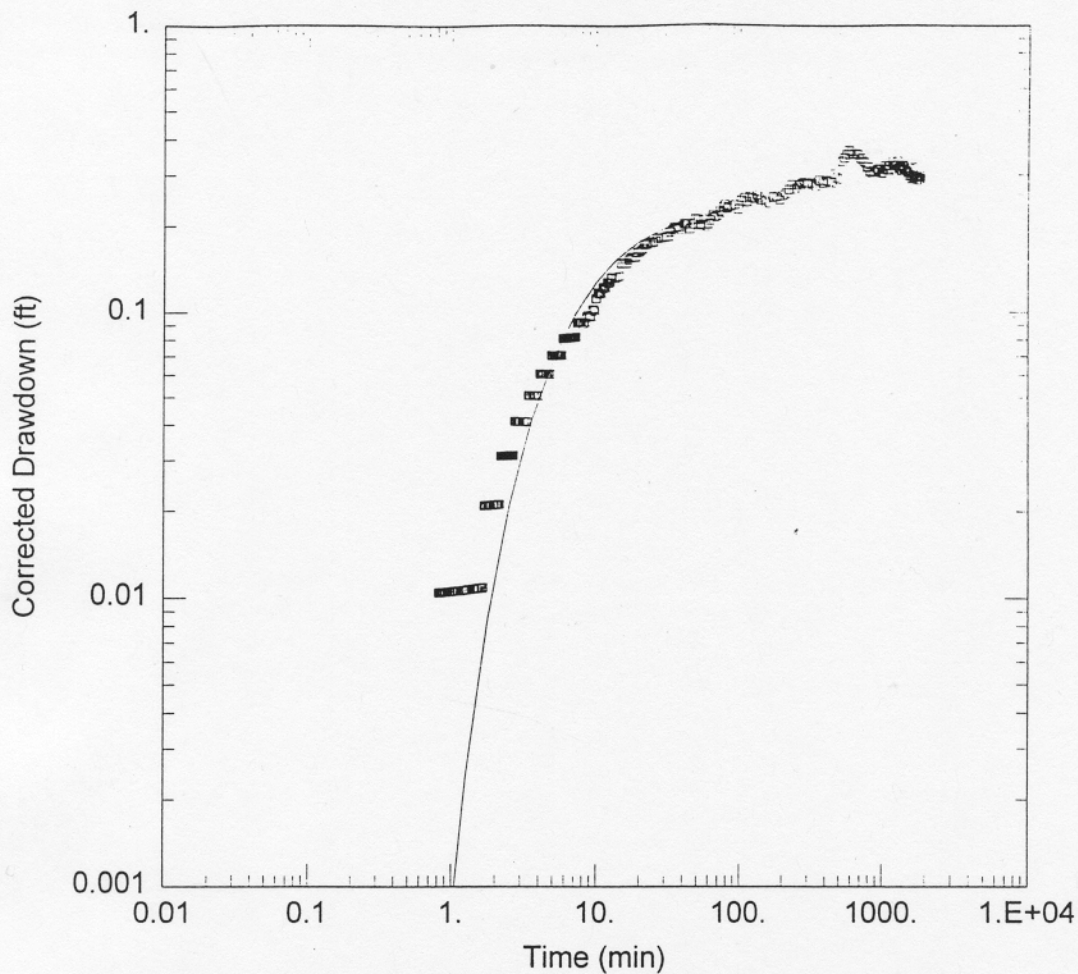

NAS NI SITE 9 PUMPING TEST DATA - MW52

Data Set: S:\NOVOCs\WORKIN~2\CONSTA~2\MW52-88.AQT

Date: 02/12/99

Time: 17:26:23

SOLUTION

Aquifer Model: Unconfined

Solution Method: Neuman

$T = 2550. \text{ ft}^2/\text{day}$

$S = 0.003845$

$S_y = 0.1$

$\beta = 0.09$

NAS NORTH ISLAND SITE 9
NoVOCs™ HYDROGEOLOGICAL INVESTIGATION

FIGURE 5-30
MW52 DRAWDOWN DATA PLOT
AND TYPE CURVE MATCH
(Upper Aquifer Zone Constant Rate Pumping Test)



Tetra Tech EM Inc.

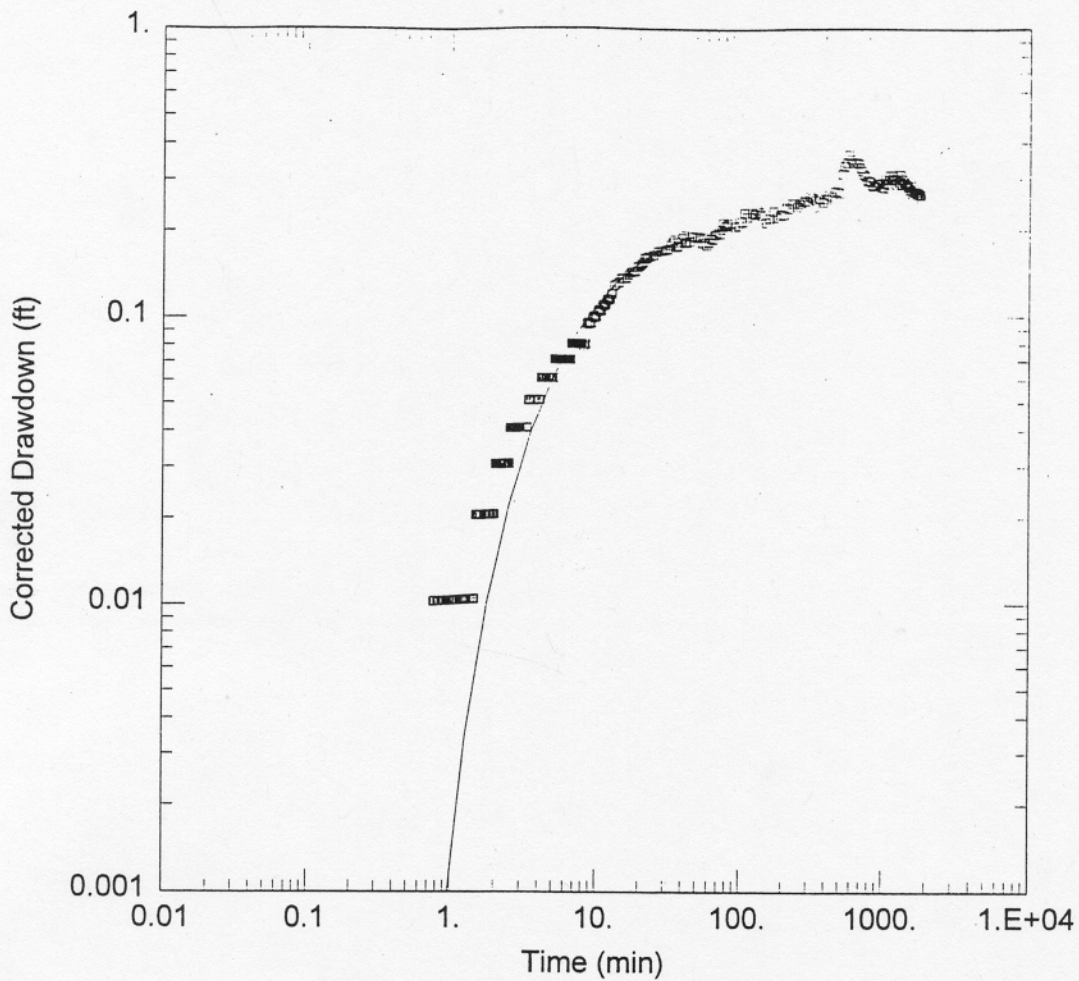

NAS NI SITE 9 PUMPING TEST DATA - MW53

Data Set: S:\NOVOCs\WORKIN~2\CONSTA~2\MW53-88.AQT

Date: 02/12/99

Time: 17:26:32

SOLUTION

Aquifer Model: Unconfined

Solution Method: Neuman

$T = 2198.7 \text{ ft}^2/\text{day}$

$S = 0.001353$

$S_y = 0.04903$

$\beta = 0.1$

NAS NORTH ISLAND SITE 9
NoVOCs™ HYDROGEOLOGICAL INVESTIGATION

FIGURE 5-31
MW53 DRAWDOWN DATA PLOT
AND TYPE CURVE MATCH
(Upper Aquifer Zone Constant Rate Pumping Test)



Tetra Tech EM Inc.

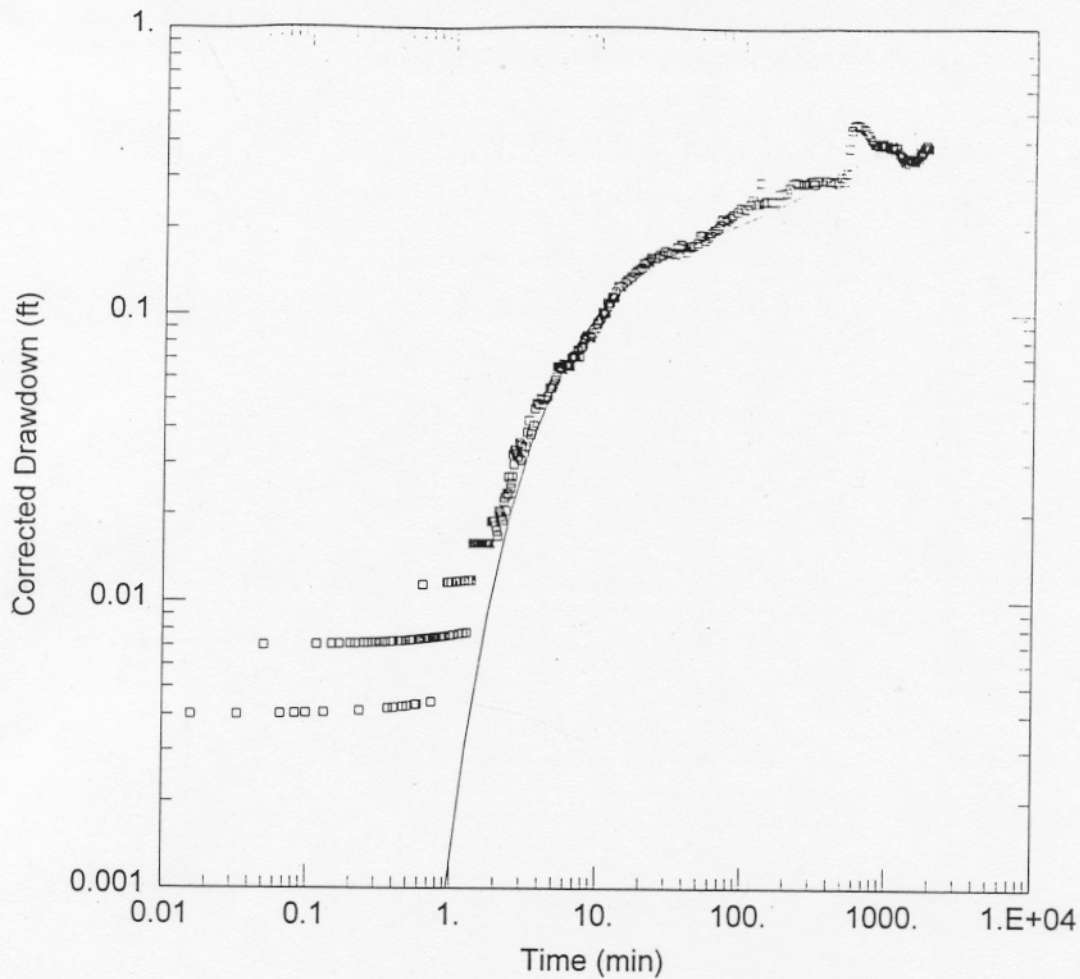

NAS NI SITE 9 PUMPING TEST DATA - MW54

Data Set: S:\NOVOC\WORKIN~2\CONSTA~2\MW54-88.AQT

Date: 02/12/99

Time: 17:26:44

SOLUTION

Aquifer Model: Unconfined

Solution Method: Neuman

$T = 2515. \text{ ft}^2/\text{day}$

$S = 0.002144$

$S_y = 0.015$

$\beta = 0.12$

NAS NORTH ISLAND SITE 9
NoVOCs™ HYDROGEOLOGICAL INVESTIGATION

FIGURE 5-32
MW54 DRAWDOWN DATA PLOT
AND TYPE CURVE MATCH
(Upper Aquifer Zone Constant Rate Pumping Test)



Tetra Tech EM Inc.



4th STREET WEST

EXISTING SVE PAD

NoVOCS-THERMATRIX EQUIPMENT PAD

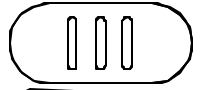

PROPANE TANKS

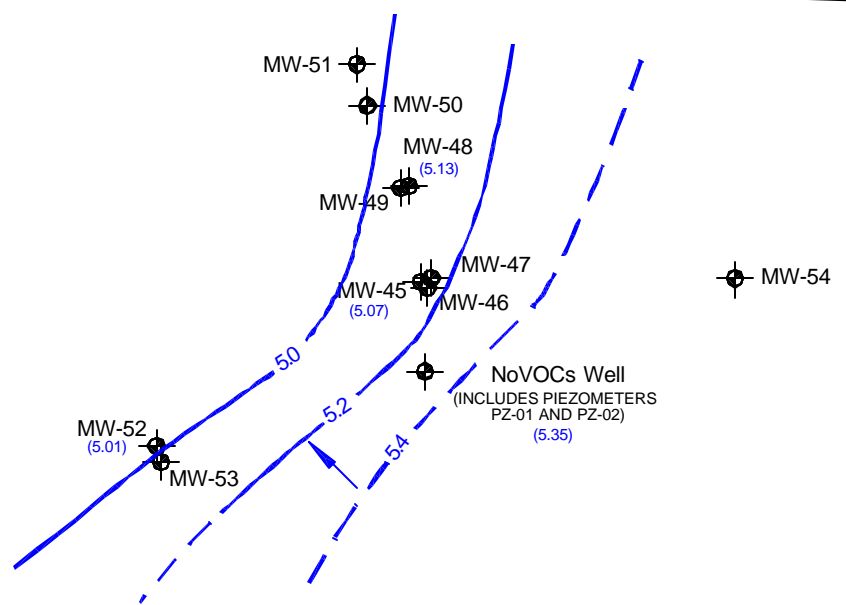

N 3rd STREET WEST



LEGEND

-  MW-52 (5.01) MONITORING WELL OR NoVOCS WELL (Equivalent Fresh Water Head Elevation in Feet)
-  5.0 THE MEAN EQUIVALENT FRESH WATER HEAD ELEVATION (MLLW) CONTOUR LINE WITH CONTOUR INTERVAL IN FEET
-  MEAN GROUND WATER FLOW DIRECTION

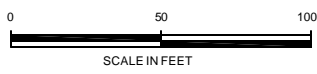

NAS NORTH ISLAND SITE 9
NoVOCS™ HYDROGEOLOGICAL INVESTIGATION

FIGURE 5-33

THE MEAN EQUIVALENT FRESH-WATER HEAD CONTOUR AND HORIZONTAL GROUNDWATER FLOW DIRECTION (Upper Aquifer Zone, Four Data Points, August 1998)

 Tetra Tech EM Inc.



4th STREET WEST

EXISTING SVE PAD



NoVOCS-THERMATRIX EQUIPMENT PAD

PROPANE TANKS

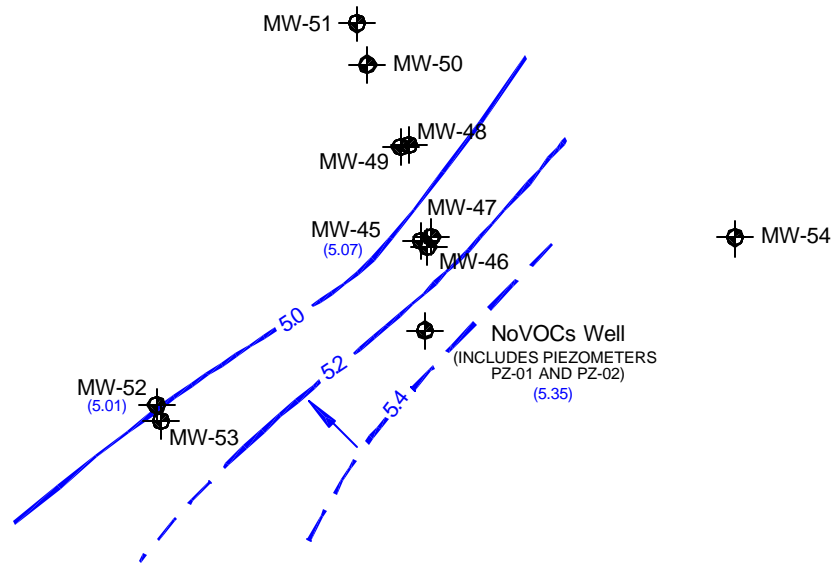
N 3rd STREET WEST



LEGEND

-  MW-52 (5.01) MONITORING WELL OR NoVOCS WELL (Equivalent Fresh Water Head Elevation in Feet)
-  5.0 THE MEAN EQUIVALENT FRESH WATER HEAD ELEVATION (MLLW) CONTOUR LINE WITH CONTOUR INTERVAL IN FEET
-  MEAN GROUND WATER FLOW DIRECTION

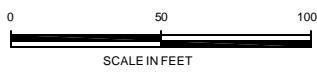

NAS NORTH ISLAND SITE 9
NoVOCS™ HYDROGEOLOGICAL INVESTIGATION



FIGURE 5-34

THE MEAN EQUIVALENT FRESH-WATER HEAD CONTOUR AND HORIZONTAL GROUNDWATER FLOW DIRECTION (Upper Aquifer Zone, Three Data Points, August 1998)

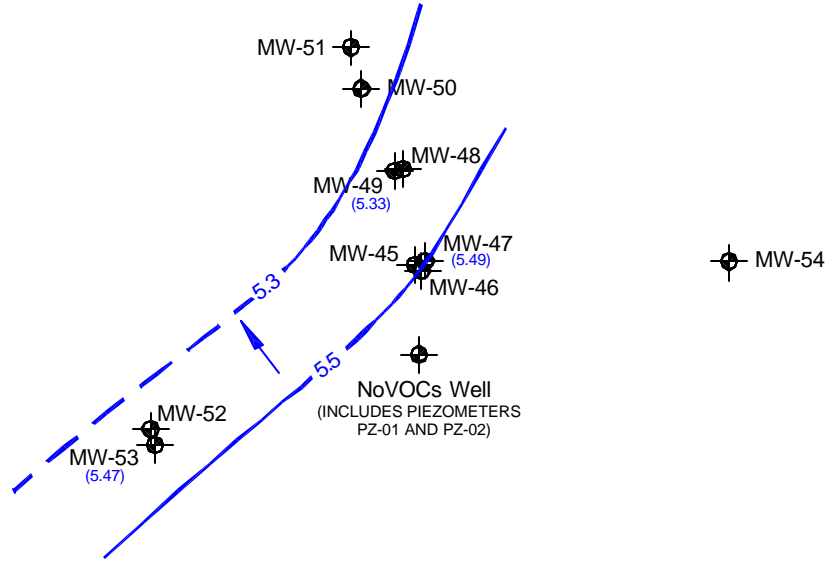
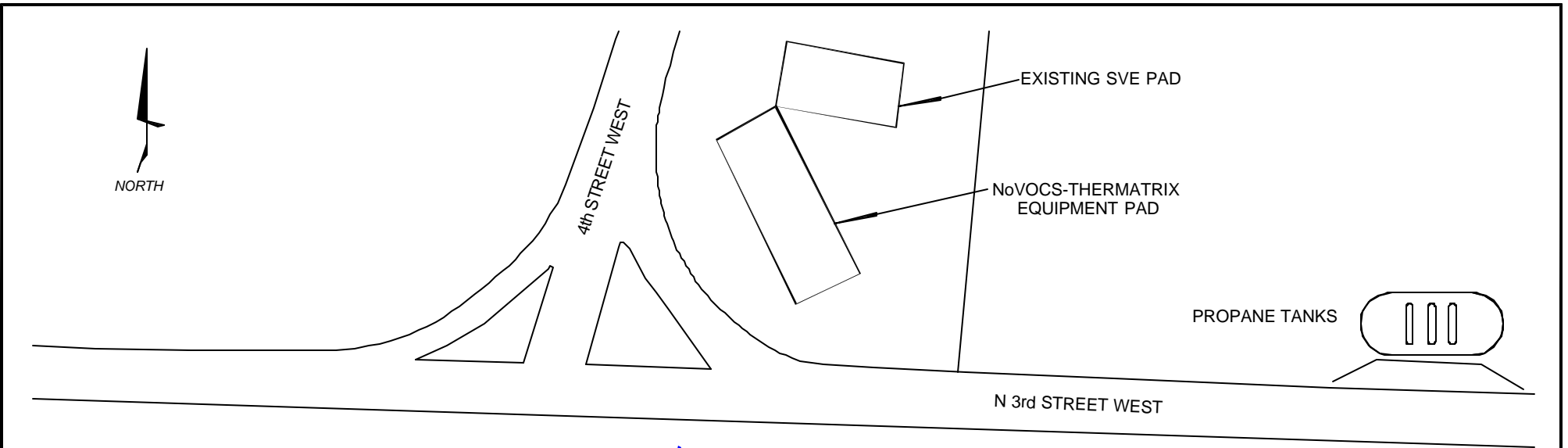
 Tetra Tech EM Inc.



LEGEND

-  MW-53 (5.47) MONITORING WELL OR NoVOCS WELL (Equivalent Fresh Water Head Elevation in Feet)
-  5.3 THE MEAN EQUIVALENT FRESH-WATER HEAD ELEVATION (MLLW) CONTOUR LINE WITH CONTOUR INTERVAL IN FEET
-  MEAN GROUND WATER FLOW DIRECTION



NAS NORTH ISLAND SITE 9
NoVOCS™ HYDROGEOLOGICAL INVESTIGATION

FIGURE 5-35

THE MEAN EQUIVALENT FRESH-WATER HEAD CONTOUR
AND HORIZONTAL GROUNDWATER FLOW DIRECTION
(Lower Aquifer Zone, Three Data Points, August 1998)

 **Tetra Tech EM Inc.**

TABLE 5-1

**TIDAL INFLUENCE PARAMETER VALUES
TIDAL INFLUENCE STUDY OF APRIL 10 THROUGH 20, 1998
NoVOCs™HYDROGEOLOGICAL INVESTIGATION
NAS NORTH ISLAND**

Measurement Point	Range (feet)			Tidal Efficiency			Time Lag (minutes)		
	Minimum	Maximum	Mean	Minimum	Maximum	Mean	Minimum	Maximum	Mean
San Diego Bay	1.72	8.11	5.27	1.00	1.00	1.00	0	0	0
MW45	0.11	0.58	0.36	0.05	0.08	0.07	52	94	70
MW46	0.09	0.56	0.36	0.05	0.08	0.07	52	94	71
MW47	0.09	0.58	0.36	0.05	0.08	0.07	46	94	72
MW48	0.10	0.58	0.36	0.05	0.08	0.07	52	90	72
MW49	0.11	0.58	0.37	0.05	0.08	0.07	56	93	71
MW50	0.10	0.60	0.37	0.05	0.08	0.07	52	96	72
MW52	0.12	0.72	0.46	0.07	0.10	0.09	46	85	69
MW53	0.12	0.73	0.45	0.06	0.10	0.09	54	93	70

Note:

Values presented are based on calculations for each of the 39 tidal periods during the 10-day study. A tidal period extends from consecutive high to low or low to high tidally influenced groundwater levels.

TABLE 5-2

**PARAMETERS USED IN TIDAL CORRECTION
FOR THE CONSTANT DISCHARGE PUMPING TEST
NoVOCs™ HYDROGEOLOGICAL INVESTIGATION
NAS NORTH ISLAND**

Well ID	Tidal Efficiency			Time Lag (minutes)		
	Minimum	Maximum	Mean	Minimum	Maximum	Mean
MW45	0.05	0.10	0.09	52	94	73
MW46	0.05	0.10	0.09	52	94	72
MW47	0.05	0.10	0.09	50	94	72
MW48	0.05	0.10	0.08	52	93	71
MW49	0.05	0.10	0.08	52	93	70
MW52	0.07	0.11	0.10	50	90	70
MW53	0.06	0.11	0.10	50	90	70
MW54	0.05	0.09	0.07	52	94	72

TABLE 5-3

**AQUIFER TEST DATA AND THE NoVOCs™ WELL SPECIFIC CAPACITY
NoVOCs™ HYDROGEOLOGICAL INVESTIGATION
NAS NORTH ISLAND**

Type of Test	Test Step	Pumping or Recharge Rate (Q) (gpm)	Measured Maximum Drawdown or Water Level Rise(s) (feet)	Specific Capacity^a (gpm/foot)	Average Specific Capacity (gpm/ft)
Upper Aquifer zone Step Drawdown Test	1	10	5.89	1.70	1.48
	2	15	11.08	1.35	
	3	20	14.31	1.40	
Upper Aquifer zone Injection Test	1	5	3.45	1.45	1.50
	2	15	9.54	1.57	
	3	22	14.82	1.48	
	4	25	16.56	1.51	
Deep Aquifer zone Step Drawdown Rest	1	40	11.40	3.51	3.22
	2	50	15.35	3.26	
	3	64	20.86	3.07	
	4	30	9.92	3.02	

Notes:

- a Specific capacity was calculated by dividing pumping or recharge rate (Q) by maximum drawdown or water level rise (s).
- gpm gallons per minute

TABLE 5-4

**AQUIFER TEST DATA AND WELL EFFICIENCY
NoVOCs™HYDROGEOLOGICAL INVESTIGATION
NAS NORTH ISLAND**

Type of Test	Pumping or Recharge Rate (Q) (gpm)	Measured Maximum Drawdown or Water Level Rise (s) (feet)	Well Loss Coefficient ^a (C)	Well Loss ^a (CQ ²) (feet)	Well Efficiency ^b (%)	Average Well Efficiency (%)
Upper Aquifer zone Step Drawdown Test	10	5.89	0.0084 ^c	0.84	85	82
	15	11.08		1.89	83	
	20	14.31		3.36	77	
Upper Aquifer zone Injection Test	5	3.45	0.0012 ^d	0.03	99	97
	15	9.54		0.27	97	
	22	14.82		0.58	96	
	25	16.56		0.75	95	
Deep Aquifer zone Step Drawdown Test	30	9.92	0.0006 ^e	0.54	95	91
	40	11.57		0.96	92	
	50	15.35		1.50	90	
	64	20.86		2.46	88	

Notes:

a Defined by Equation 5-18

b Calculated using Equation 5-19, where well efficiency in percent (E_{well}) is defined as follows:
$$E_{well} = \frac{s - CQ^2}{s} \times 100$$

c From best fit equation for data in Figure 5-11

d From best fit equation for data in Figure 5-12

e From best fit equation for data in Figure 5-13

gpm gallons per minute

TABLE 5-5

**UPPER AQUIFER ZONE
CONSTANT DISCHARGE PUMPING TEST CONFIGURATION
NoVOCs™HYDROGEOLOGICAL INVESTIGATION
NAS NORTH ISLAND**

GENERAL INFORMATION			
Pumping well:	NoVOCs™well (upper screen interval)		
Pumping well casing diameter:	8 inches		
Pumping rate:	20 gallons per minute		
Pumping duration:	32 hours		
Initial groundwater level:	17 feet bgs		
Aquifer saturation thickness:	88 feet		
PUMPING AND OBSERVATION WELL INFORMATION			
Well ID ^a	Distance from the Pumping Well (feet)	Screen Interval	
		Depth (feet bgs)	Elevation (feet relative to MLLW)
IW-01 (NoVOCs™well)	0	43 to 47 and 72 to 78	-21.3 to -25.3 and -50.3 to -56.3
MW-45	29.8	42 to 47	-20.0 to -25.0
MW-46	27.7	57 to 62	-35.4 to -40.4
MW-47	31.1	72 to 78	-49.9 to -55.9
MW-48	61.9	52 to 57	-28.6 to -33.6
MW-49	61.7	67 to 72	-43.6 to -48.6
MW-52	93.0	41 to 46	-19.1 to -24.1
MW-53	93.1	72 to 77	-50.4 to -55.4
MW-54	107.9	38 to 78	-18.0 to -58.0

Notes:

- a Observation wells MW-50 and MW-51 are not included because no data are available due to datalogger malfunction
- bgs Below ground surface
- MLLW Mean lower low water level

TABLE 5-6

**CONSTANT DISCHARGE PUMPING TEST INFORMATION
NoVOCs™HYDROGEOLOGICAL INVESTIGATION
NAS NORTH ISLAND**

Well ID	Well Function	Distance from Pumping Well (feet)	Initial Response Time (minute)	Maximum Drawdown at the End of the Test ^a (feet)	Screen Interval	
					Depth (feet bgs)	Elevation (feet relative to MLLW)
NoVOCs™Well (upper screen)	Pumping	0	0	16.02	43 to 47	-21.3 to -25.3
MW-45	Observation	29.8	0.51	0.63	42 to 47	-20.0 to -25.0
MW-46	Observation	27.7	0.53	0.46	57 to 62	-35.4 to -40.4
MW-47	Observation	31.1	0.66	0.40	72 to 78	-49.9 to -55.9
MW-48	Observation	61.9	0.75	0.23	52 to 57	-28.6 to -33.6
MW-49	Observation	61.7	0.75	0.18	67 to 72	-43.6 to -48.6
MW-52	Observation	93.0	0.80	0.22	41 to 46	-19.1 to -24.1
MW-53	Observation	93.1	0.90	0.20	72 to 77	-50.4 to -55.4
MW-54	Observation	107.9	1.30	0.26	38 to 78	-18.0 to -58.0

Notes:

- a Observation well drawdown data have been tidally corrected
- bgs Below ground surface
- MLLW Mean lower low water level

TABLE 5-7

**AQUIFER HYDRAULIC PARAMETERS
UPPER AQUIFER CONSTANT DISCHARGE PUMPING TEST
NOVOCS™ HYDROGEOLOGICAL INVESTIGATION
NAS NORTH ISLAND**

Observation Well	Transmissivity (T) (feet ² /day)	Hydraulic Conductivity (K)		Storativity (S) (dimensionless)	Specific Yield (S _y) (dimensionless)	Neuman Delayed Yield factor (b) (dimensionless)	Ratio of Vertical to Horizontal K (K _z /K _r) (dimensionless)
		(feet/day)	(cm/sec)				
MW-45	2,450	28	0.010	0.0084	0.12	0.03	0.26
MW-46	2,722	31	0.011	0.0073	0.05	0.03	0.30
MW-47	2,441	28	0.010	0.0019	0.06	0.03	0.24
MW-48	2,553	29	0.010	0.0045	0.09	0.09	0.18
MW-49	2,774	32	0.011	0.0022	0.11	0.08	0.16
MW-52	2,550	29	0.010	0.0038	0.10	0.09	0.08
MW-53	2,199	25	0.009	0.0014	0.05	0.10	0.09
MW-54	2,515	29	0.010	0.0021	0.02	0.12	0.08
Average	2,526	29	0.010	0.0040	0.07	0.07	0.17
DFT	2,771	33	0.0115	0.001~0.01	N/A	N/A	0.20

TABLE 5-8

**MEAN GROUNDWATER AND EQUIVALENT FRESH-WATER HEADS
NoVOCs™HYDROGEOLOGICAL INVESTIGATION
NAS NORTH ISLAND**

Aquifer Zone	Well ID	Mean Groundwater Elevation after Tidal Correction (feet MLLW)	Parameters Used in Calculating Equivalent Fresh- Water Heads				Equivalent Fresh - Water Heads ^c (feet MLLW)
			TDS Concentration (mg/L)	Groundwater Density ^a (kg/m ³)	Groundwater Specific Gravity (unitless)	Well Screen Elevation ^b (feet MLLW)	
Upper Zone	MW45	4.78	17,600	1,011	1.011	-22.51	5.07
	MW48	4.56	25,700	1,016	1.016	-31.08	5.13
	MW52	4.64	22,700	1,014	1.014	-21.55	5.01
	PW	4.97	21,300	1,013	1.013	-23.77	5.35
Lower Zone	MW47	4.33	32,000	1,020	1.020	-52.35	5.49
	MW49	4.40	29,200	1,019	1.019	-46.08	5.33
	MW53	4.34	31,000	1,020	1.020	-52.91	5.47

Notes:

- A Density is calculated based on Equation 5-31
- B Well screen elevation is determined as the middle point of the well screen
- C Equivalent fresh- water head is calculated based on Equation 5-30

6.0 CONCLUSIONS

The hydrogeological investigation of the aquifer treated by the NoVOCs™ system has yielded valuable information regarding the hydraulic characteristics of the aquifer, pumping and injection capacities of the NoVOCs™ well, and defects in the NoVOCs™ well. The conclusions of the investigation are as follows:

- The tested aquifer is significantly influenced by tidal fluctuations in San Diego Bay, as demonstrated by the drawdown data collected from the observation wells during the constant discharge pumping test of the NoVOCs™ well.
- The tidal effects on groundwater levels must be corrected to allow the calculation of aquifer parameters and the mean groundwater elevations.
- Groundwater levels must be corrected for density effect for determination of groundwater flow patterns. The mean equivalent fresh water head contour maps show that groundwater at the vicinity of the NoVOCs™ well flows to the west or northwest in both of the upper and lower aquifer zones. The horizontal hydraulic gradient of the two aquifer zones ranges from 0.005 to 0.01.
- Two methods were developed for tidal correction of groundwater drawdown data obtained during the constant discharge pumping test. The methods involve using the tidal influence study data collected in April 1998 to calculate the tidal efficiency and time lag for each of the observation wells. The estimated tidal efficiency ranges from 0.05 to 0.1 in different tidal cycles at different wells; the estimated time lags range from 46 to 96 minutes.
- Observed drawdown data collected during the constant discharge pumping test were corrected using the two new tidal correction methods. The corrected drawdown (that is, drawdown data with the tidal effects removed) using both methods correlates well with each other and reflects typical pumping test responses. The corrected drawdown matches reasonably well with Neuman type curves for the aquifer parameter estimation.
- The aquifer hydraulic parameters were estimated based on the tidally corrected groundwater drawdown data for the constant discharge pumping test. The average hydraulic conductivity was estimated as 29ft/day or 0.01 cm/sec. The average aquifer storativity and specific yield are 0.004 and 0.07. The average ratio of horizontal to vertical hydraulic conductivity is estimated at 5.7.
- Specific capacity and efficiency of the NoVOCs™ well were estimated based on the step-drawdown tests and water injection test conducted at the NoVOCs™ well. The calculated average specific capacities are 1.48 gpm/ft for the upper screened pumping, 1.50 gpm/ft for the upper screened injection, and 3.22 gpm/ft for the lower screened pumping. The calculated average well efficiencies are 82 percent for the upper screened pumping, 97 percent for the upper screened injection, and 91 percent for the lower screened pumping. The 97-percent well efficiency for the upper screened injection is for injection of clean tap water.

- The radius of influence during the constant discharge pumping test (20 gpm) was at least 100 feet based on drawdown measured at the observation wells. No data were collected from the observation well farthest from the pumping well (MW-54), which is 105 feet from the NoVOCs™ well.
- No positive (recharge) or negative (flow barrier) boundaries are evident from the constant discharge pumping test data.
- The injection test results show that the maximum flow of clean tap water that can be injected through the upper screen of the NoVOCs™ well is 25 gpm. At that injection rate, the water level will rise 17 feet and reach the ground surface.
- The video survey of the NoVOCs™ well revealed a manufacturing defect in the upper well screen. The screen slots are unevenly cut, and about 30 percent of the slots do not completely penetrate the PVC casing. This defect affects the well efficiency of the upper screened interval and may reduce the available water level rise in the NoVOCs™ well during recharge to the aquifer through the upper screen.
- The video survey also revealed significant fouling of the NoVOCs™ well screens by iron precipitation and microbiological growth. Such fouling may impair the performance of the NoVOCs™ system by obstructing the well screen and filter pack.
- The findings of the aquifer tests and tidal study of the aquifer treated by the NoVOCs™ system indicate that the aquifer hydraulic conditions are suitable for application of the NoVOCs™ technology. The NoVOCs™ well as designed should be able to extract and inject a flow rate of 20 gpm based on the aquifer hydraulic characteristics.

7.0 REFERENCES

- Bechtel National, Inc. (Bechtel). 1996. Final Technical Memorandum, Additional Site Characterization for NoVOCs™ Technology Demonstration at Site 9, Naval Air Station (NAS) North Island, San Diego, California. CTO-0084/0065. March.
- Bechtel. 1997a. Final Technical Memorandum, S9-CPT-05 Site Characterization for NoVOCs™ Technology at Site 9, NAS North Island, San Diego, California. CTO-0084/0160. June.
- Bechtel. 1997b. Draft Addendum to Action Memorandum/Remedial Action Plan for Removal Action at Installation Restoration Site 9, Naval Air Station North Island, Coronado, California. CTO-084/0159. June.
- Bechtel. 1998. Final Boring Logs, Cone Penetrometer Test Data, and Geologic Cross-Section of Site 9. Naval Air Station North Island.
- Bierschenk, W.H. 1964. "Determining Well Efficiency by Multiple Step-Drawdown Tests." Publication 64, International Association of Scientific Hydrology.
- de Marsily, G. 1986. *Quantitative Hydrogeology*. Academic Press, Inc. Page 440.
- Dawson, K.J. and J.D. Istok 1991. *Aquifer Testing, Design and Analysis of Pumping and Slug Tests*. Lewis publishers. Chelsea, Michigan.
- Driscoll, Fletcher, G. 1986. *Groundwater and Wells*. Second Edition.
- Duffield, G.M. and J.O. Rumbaugh, III. 1991. "AQTESOLV—Aquifer Test Solver." Geraghty & Miller Modeling Group. Reston, Virginia.
- EG&G Environmental (EG&GE). 1996. Final Work Plan for NoVOCs™ Pilot Test at NAS North Island. June.
- EG&GE. 1997. Well Design for NAS North Island. August 13.
- Erskine, A.D. 1991. "The Effect of Tidal Fluctuation on a Coastal Aquifer in the UK." *Groundwater*. Vol. 29, No. 4. Pages 556-562.
- Ferris, J.G. 1951. "Cyclic Fluctuations of Water Level as a Basis for Determining Aquifer Transmissivity." *International Association of Scientific Hydrology. Publication 33*. Pages 148-155.
- Freeze, R.A., and J.A. Cherry. 1979. *Groundwater*. Prentice-Hall, Inc. Englewood Cliffs, NJ.
- Jacob, C.E. 1947. "Drawdown Test to Determine Effective Radius of Artesian Well". ASCE Transactions. Vol. 112, Paper 2321. Pages 1047-1070.
- Jacob, C.E. 1950. *Flow of Ground Water. Engineering Hydraulics*. Edited by H. Rouse. John Wiley and Sons, Inc., New York. Pages 321-386.

- Jacobs Engineering Group, Inc. (Jacobs). 1994. Technical Memorandum, Site 9 - Chemical Waste Disposal Area, NAS North Island, Volume I, Revision 0. April 6.
- Jacobs. 1995a. Draft Remedial Investigation/Resource Conservation and Recovery Act Facility Investigation Report, Site 9 - Chemical Waste Disposal Area, NAS North Island, Volume I, Revision 0. October.
- Jacobs. 1995b. Naval Air Station North Island, San Diego, California, Remedial Investigation, RCRA Facility Investigation Report, Site 9, Chemical Waste Disposal Area. October.
- HydroSOLVE, Inc. 1996. AQTESOLV for Windows, User's Guide.
- Lennox, D.H. 1966. "Analysis and Application of Step-Drawdown Test. *Journal of the Hydraulics*. ASCE DIV. HY 6. November, Pages 25-48.
- Kabala, Z.J. 1993. "The Dipole Flow Test: A New Single Borehole Test for Aquifer Characterization." *Water Resources Research*. Vol. 29, No. 1. Page 99-107. January.
- Kawecki, M.W. "Meaningful Interpretation of Step-Drawdown Tests." *Ground Water*. Vol. 33, No. 1. Pages 23-32.
- Kennedy. 1975. Geology of the San Diego Metropolitan Area, California. California Division of Mines and Geology. Bulletin 200.
- Neuman, S.P. 1974. "Effect of partial penetration on flow in unconfined aquifers considering delayed gravity response." *Water Resources Research*. Vol. 10, No. 2. Pages 303-312.
- Neuman, S.P. 1975. "Analysis of Pumping Test Data from Anisotropic Unconfined Aquifers Considering Delayed Gravity Response." *Water Resources Research*. Vol. 11, No. 2. Pages 329-342.
- Rorabaugh, M.I. 1953. "Graphical and Theoretical Analysis of Step-Drawdown Test of Artesian Well." ASCE Proceedings Separate No. 362. Vol.79. Pages 1-23.
- Serfes, M.E. 1991. "Determining the Mean Hydraulic Gradient of Ground Water Affected by Tidal Fluctuations." *Groundwater*. Vol. 29, No. 4. Pages 549-555.
- SPARWAR Systems Center (SPARWAR). 1998. Draft Report of Findings: Offshore Sampling of Porewater VOC Levels and Groundwater VOC Fluxes to San Diego Bay at Site 9, Naval Air Station North Island. SPARWAR Systems Center, San Diego, California.
- Tetra Tech EM Inc. 1998. Technology Evaluation Plan/Quality Assurance Project Plan for the MACTEC Environmental NoVOCs™ Technology Evaluation at the Naval Air Station, North Island, California. May.
- Theis, C.V. 1935. "The relation between the lowering of the piezometric surface and the rate and duration of discharge of a well using groundwater storage." *American Geophysical Union Trans.* Volume 16. Pages 519-524.