

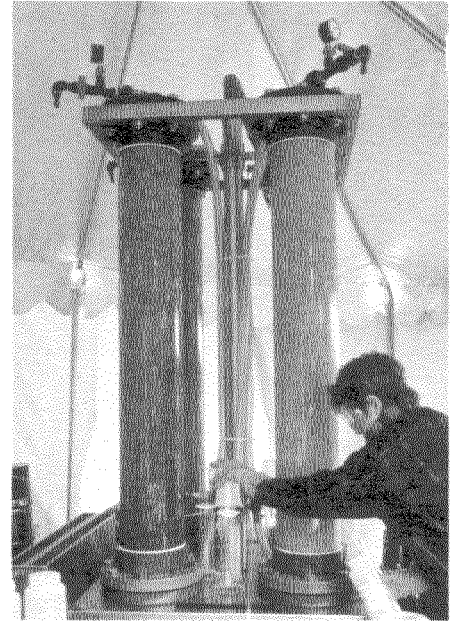

Dynaphore, Inc. Forager™ Sponge Technology

Innovative Technology Evaluation Report

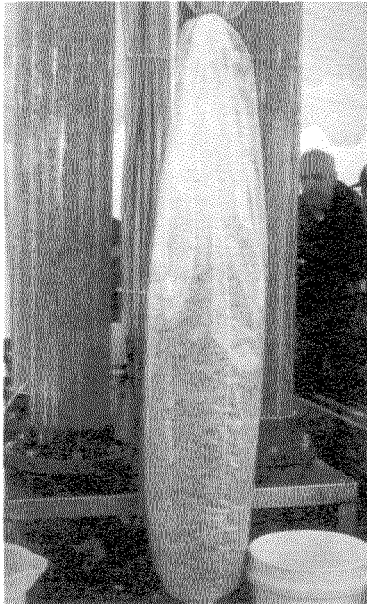
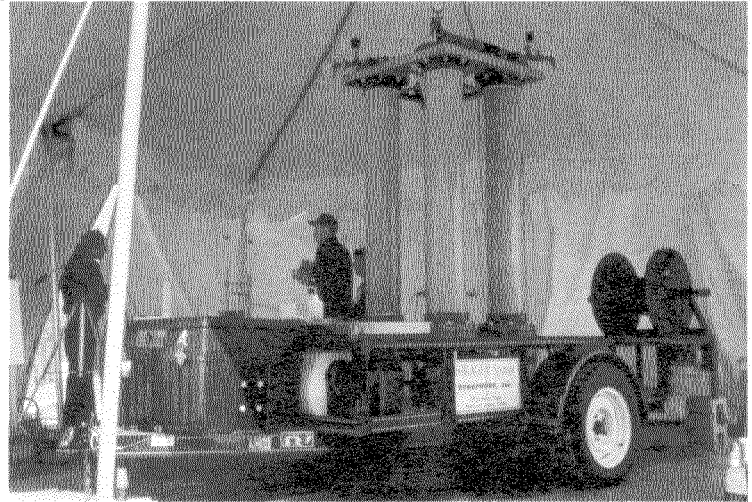
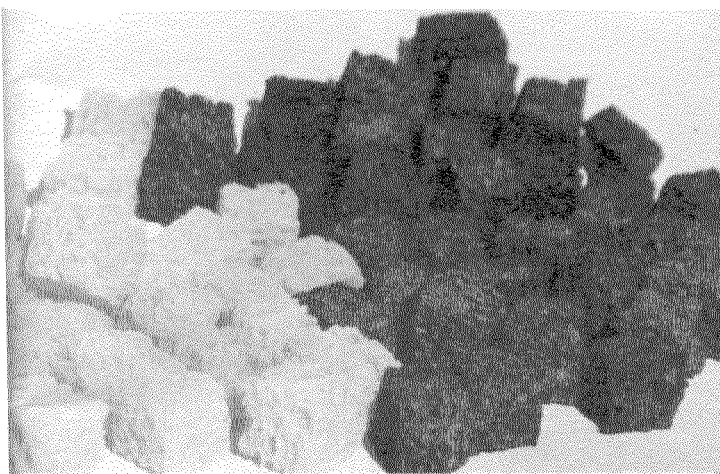

SITE
SUPERFUND INNOVATIVE
TECHNOLOGY EVALUATION

**DYNAPHORE, INC.
FORAGER™ SPONGE TECHNOLOGY**

INNOVATIVE TECHNOLOGY EVALUATION REPORT

**RISK REDUCTION ENGINEERING LABORATORY
OFFICE OF RESEARCH AND DEVELOPMENT
U.S. ENVIRONMENTAL PROTECTION AGENCY
CINCINNATI, OHIO 45268**



NOTICE

The information in this document has been prepared for the U.S. Environmental Protection Agency's (EPA's) Superfund Innovative Technology Evaluation (SITE) Program under Contract No. 68-CO-0048. This document has been subjected to the EPA's peer and administrative reviews and has been approved for publication as an EPA document. Mention of trade names of commercial products does not constitute an endorsement or recommendation for use.

FOREWORD

The Superfund Innovative Technology Evaluation (SITE) Program was authorized by the Superfund Amendments and Reauthorization Act (SARA) of 1986. The Program is administered by the EPA Office of Research and Development (ORD). The purpose of the SITE Program is to accelerate the development and use of innovative cleanup technologies applicable to Superfund and other hazardous waste sites. This purpose is accomplished through technology demonstrations designed to provide performance and cost data on selected technologies.

This project consisted of a demonstration conducted under the SITE Program to evaluate the Dynaphore, Inc. Forager™ Sponge Technology for the treatment of heavy metal contaminated groundwater. The technology demonstration was conducted at the NL Industries, Inc. Superfund site located in Pedricktown, New Jersey. The demonstration provided information on the performance and cost of the technology. This Innovative Technology Evaluation Report presents an interpretation of the data and discusses the potential applicability of the technology.

A limited number of copies of this report will be available at no charge from the EPA's Center for Environmental Research Information, 26 West Martin Luther King Drive, Cincinnati, Ohio, 45268. Requests should include the EPA document number found on the report's cover. When the limited supply is exhausted, additional copies can be purchased from the National Technical Information Service (NTIS), Ravensworth Building, Springfield, Virginia 22161, (703) 487-4600. Reference copies will be available at EPA libraries in the Hazardous Waste Collection. You can also call the SITE Clearinghouse Hotline at (800) 424-9346 or (202) 382-3000 in Washington, D.C. to inquire about the availability of other reports.

E. Timothy Oppelt, Director
Risk Reduction Engineering Laboratory

TABLE OF CONTENTS

<u>Section</u>	<u>Page</u>
NOTICE	ii
FOREWORD	i
ABSTRACT	iv
LIST OF TABLES	vii
LIST OF FIGURES	vii
ACKNOWLEDGEMENTS	viii
 Executive Summary	 1
 Section 1 Introduction	 6
1.1 Background	6
1.2 Brief Description of Program and Reports	7
1.3 The SITE Demonstration Program	8
1.4 Purpose of the Innovative Technology Evaluation Report (ITER)	9
1.5 Technology Description.	9
1.6 Key Contacts	11
 Section 2 Technology Applications Analysis	 12
2.1 Key Features of the Dynaphore, Inc. Forage?™ Sponge Technology	12
2.2 Operability of the Technology	13
2.3 Applicable Wastes	15
2.4 Availability and Transportability of Equipment	16
2.5 Materials Handling Requirements	17
2.6 Range of Suitable Site Characteristics	18
2.7 Limitations of the Technology	19
2.8 ARARs for the Dynaphore, Inc. Forage?™ Sponge Technology	20
2.8.1 Comprehensive Environmental Response, Compensation, and Liability Act (CERCLA)	21
2.8.2 Resources Conservation and Recovery Act (RCRA)	25
2.8.3 Clean Water Act (CWA)	26
2.8.4 Safe Drinking Water Act (SDWA)	27
2.8.5 Occupational Safety and Health Administration (OSHA) Requirements	27
2.8.6 Radioactive Waste Regulations	28
2.8.7 Mixed Waste Regulations	29
 Section 3 Economic Analysis	 30
3.1 Conclusions of Economic Analysis	30
3.2 Basis for Economic Analysis	35
3.3 Issues and Assumptions	36
3.4 Results of the Economic Analysis	37
3.4.1 Site Preparation	37

TABLE OF CONTENTS (continued)

3.4.2	Permitting and Regulatory Requirements	38
3.4.3	Capital Equipment	39
3.4.4	Startup	39
3.4.5	Consumable and Supplies	40
3.4.6	L a b o r	42
3.4.7	U t i l i t i e s	43
3.4.8	Effluent Treatment and Disposal	44
3.4.9	Residuals and Waste Shipping and Handling Costs	44
3.4.10	Analytical Services	45
3.4.11	Maintenance and Modifications	46
3.4.12	D e m o b i l i z a t i o n	46
Section 4	Treatment Effectiveness During the SITE Demonstration	47
4.1	B a c k g r o u n d	47
4.2	Detailed Process Description	48
4.3	Methodology	49
4.4	P e r f o r m a n c e D a t a	50
4.4.1	Summary of Results for Critical Parameters	50
4.4.2	Summary of Results for Non-Critical Parameters	59
4.4	Process Residuals	63
Section 5	Other Technology Requirements	65
5.1	Environmental Regulation Requirements	65
5.2	Personnel Issues	65
5.3	Community Acceptance	66
Section 6	Technology Status	67
6.1	Previous Experience	67
6.2	Scaling Capabilities	67
Appendix A	Vendor Claims	68

LIST OF TABLES

<u>Table</u>		<u>Page</u>
Table ES-1	Evaluation Criteria for the Dynaphore, Inc. Forager™ Sponge Technology	4
Table 2-1	Federal and State ARARs for the Dynaphore, Inc. Forager™ Sponge Technology ...	22
Table 3-1	Estimated Costs for Treatment Using the Dynaphore, Inc. Forage™ Sponge T e c h n o l o g y	31
Table 4-1	Treatment Performance for Critical Metals	51
Table 4-2	Cadmium Column Data	53
Table 4-3	Chromium Column Data	54
Table 4-4	Copper Column Data	55
Table 4-5	Lead Column Data	56
Table 4-6	Summary of Data for Non-Critical Heavy Metals	60
Table 4-7	Data Summary of Conventional Parameters	62

LIST OF FIGURES

<u>Figure</u>		<u>Page</u>
Figure 3-1	Percentage Breakdown by Cost Category	34
Figure 4-1	Process Flow Diagram of Dynaphore Inc. Forager™ Sponge Technology	49
Figure 4-2	Final Effluent Concentration of Critical Metals vs. Time	51
Figure 4-3	Cadmium Concentration vs. Time	57
Figure 4-4	Chromium Concentration vs. Time	57
Figure 4-5	Copper Concentration vs. Time	58
Figure 4-6	Lead Concentration vs. Time	58
Figure 4-7	pH vs. Time	64

ACKNOWLEDGEMENTS

This report was prepared under the direction and coordination of Ms. Carolyn Esposito, the EPA SITE Technical Project Manager at the Risk Reduction Engineering Laboratory (RREL) in Edison, New Jersey.

This report was prepared for EPA's Superfund Innovative Technology Evaluation (SITE) Program by Gary F. Vaccaro and Omer Kitaplioglu of Science Applications International Corporation (SAIC) for the U.S. Environmental Protection Agency under Contract No. 68-CO-0048. Major SAIC contributors to the successful completion of this project were Paul Feinberg, Andy Matuson, Rita Schmon-Stasik, Herbert S. Skovronek, and Joanne Torchia.

The cooperation and participation of Dr. Norman Rainer and Michael Rainer of Dynaphore, Inc. throughout the course of this project and in review of this report are gratefully acknowledged. Special thanks are noted to Mick Gilbert of EPA Region II, Steve Holt and Oris Ewing of NL Industries, Inc., and Lou Reynolds of Adtechs Corp.

Joyce Perdek and Uwe Frank of USEPA's Risk Reduction Engineering Laboratory provided technical reviews of the draft report.

EXECUTIVE SUMMARY

This report summarizes the findings of an evaluation of the Dynaphore, Inc. Forager™ Sponge Technology on the remediation of heavy metal contaminated groundwater at the NL Industries, Inc. Superfund Site in Pedricktown, N.J. This evaluation was conducted under the U.S. Environmental Protection Agency's (EPA) Superfund Innovative Technology Evaluation (SITE) Program.

Technology Description

The Forager™ Sponge is an open-celled cellulose sponge incorporating an amine-containing chelating polymer that selectively absorbs dissolved heavy metals from aqueous waste streams. The Developer states that the technology can be utilized to remove and concentrate heavy metals from a wide variety of contaminated aqueous media such as groundwater, surface water, landfill leachate, and industrial effluents. The selective affinity of the polymer employed allows the Sponge to preferentially bind toxic heavy metals over common innocuous cations such as Ca^{++} , Mg^{++} , K^+ , and Na^+ . The Sponge can be regenerated with chemical solutions or directly disposed; its matrix allows for compaction to a small disposal volume. The Sponge could also be incorporated into varied treatment configurations. For this demonstration the Sponge was utilized in a pump-and-treat mode as a series of four columns, mounted on a mobile trailer unit. Each column contained a removable fishnet bag of approximately 24,000 half-inch sponge cubes. The Developer also reports that the Sponge may have potential in-situ treatment applications; however, there is insufficient data currently available which demonstrates the viability of this treatment option.

The Forager™ Sponge Technology was demonstrated at the NL Industries, Inc. site in Pedricktown, N.J. from April 5 to 8, 1994. This mobile pump-and-treat system treated heavy-metal contaminated groundwater over a continuous 72-hr operational period. Based on field and laboratory treatability tests, the Developer claimed that the technology would achieve at least a 90% reduction of lead and copper, an 80% reduction of cadmium and a 50% reduction of chromium (as trivalent chrome) in the groundwater. Raw influent concentrations for these metals ranged from 426 ug/L for chromium to 917 ug/L for copper.

Conclusions from this SITE Demonstration

Based on this SITE Demonstration, the following conclusions may be drawn about the applicability of the Forager™ Sponge Technology:

- The technology was successful in meeting treatment claims for cadmium, copper and lead. Treatment claims for chromium, however, were not achieved. Specifically, based on a 90% confidence interval, cadmium was reduced by $89\% \pm 2.4\%$, lead was reduced by $96\% \pm .40\%$, and chromium was reduced by $32\% \pm 8.4\%$. Reduction in copper was determined to be $>94\%$. A confidence interval for percent reduction of copper was not calculated as all final effluent concentrations were non-detectable.
- Effective removal of cadmium, copper, and lead was achieved in the presence of a groundwater pH ranging from 3.1 to 3.8, a sulfate concentration of approximately 20,000 mg/L, a TDS concentration of approximately 23,000 mg/L, and disproportionately higher concentrations of other cations such as calcium, magnesium, sodium, and potassium. Concentrations for these cations ranged from 70 mg/L for magnesium to 6,000 mg/L for sodium. The technology's low affinity for these cations was supported by their low removal rates.
- Although treatment claims for cadmium and lead were met, some of the Sponge columns became saturated with these metals during the demonstration. Specifically, the first column became saturated with both cadmium and lead, while the second column became saturated with only cadmium. The capacity for copper was much greater, as none of the columns were saturated with copper during the demonstration. The observed absorption capacity for these metals was significantly lower than the Developer's estimates which were based on saturation levels of laboratory metal standard solutions. These results show the need to conduct treatability tests on each waste stream proposed for treatment to determine the true absorption capacity of the system prior to implementing the technology.
- The Forager™ Sponge Technology was easy to operate and exhibited no operational problems over the course of the demonstration. The system is trailer-mounted, easily transportable, and can be operational within a day of arrival at a site. The spent Sponges can be compacted into a small volume for easy disposal. Four fishnet bags of Sponges were hand compacted into one 55-gallon drum. Compactor tests done off-site utilizing an industrial waste compactor revealed that 16 to 40 bags of Sponges could be compacted into one 55-gallon drum.
- The technology's usefulness may be limited by its overall absorption capacity for the heavy metals of concern. If frequent changeout or regeneration of the columns is required, it could make this technology cost prohibitive. In these applications, pretreatment may be necessary in order to reduce the concentration of specific contaminants to technically and/or economically optimal levels.

- The cost to treat heavy metal contaminated groundwater over a one year period with the Dynaphore, Inc. Forager™ Sponge Technology is estimated at \$340/1,000 gallons, assuming the Sponges are not regenerated and are replaced upon saturation, or \$238/1,000 gallons, assuming the Sponges are regenerated twice providing for three useful treatment cycles. These cost estimates assume groundwater characteristics are similar to the demonstration groundwater, and that cadmium, lead, and copper are treated to demonstration performance claims utilizing a four-column, pump-and-treat unit similar to the demonstration unit.
- A significant portion of the cost is attributable to the frequent replacement or regeneration of the Sponges due to the limited absorption capacity for cadmium in this groundwater. The Developer believes that a modification of the polymer may improve its overall absorption capacity for the critical metals which would greatly aid in lowering treatment costs. Additionally, further cost reduction may be achieved through the use of larger scale units which could handle higher flow rates, and the use of an industrial compactor to compact Sponges which could lower disposal costs.

The Dynaphore, Inc. Forager™ Sponge Technology was evaluated based on the nine criteria used for decision-making in the Superfund Feasibility Study (FS) process. Table ES-I presents the evaluation.

TABLE ES-1. EVALUATION CRITERIA FOR THE DYNAPHORE, INC. FORAGER™ SPONGE TECHNOLOGY

OVERALL PROTECTION OF HUMAN HEALTH AND THE ENVIRONMENT	COMPLIANCE WITH FEDERAL ARARs	LONG TERM EFFECTIVENESS AND PERMANENCE	REDUCTION OF TOXICITY, MOBILITY, OR VOLUME THROUGH TREATMENT
Protects human health and the environment by removing contaminants from groundwater or surface water.	Requires compliance with RCRA treatment, storage, and disposal regulations for hazardous waste & pertinent AEA, DOE, & NRC requirements for radioactive or mixed waste.	Permanently removes contamination from affected matrix.	Volume reduction technology which transfers contaminants from aqueous media to a smaller concentrated volume.
Minimizes or eliminates the further spread of contaminants within the aquifer.	Well construction activities may require permits.	Residuals from the process must be disposed of in an appropriate manner.	Ability to compact Sponges to small volumes may be advantageous for radioactive or mixed waste.
	Wastewater discharges to POTWs or surface water bodies or underground injection wells may require compliance with the Clean Water Act or Safe Drinking Water Act.		

SHORT TERM EFFECTIVENESS IMPLEMENTABILITY COST COMMUNITY ACCEPTANCE STATE ACCEPTANCE

Presents minimal risk to workers and the community. Easily implementable and transportable. \$340 per 1,000 gallons with no regeneration.^(*) Minimal short term risks to the community make this technology attractive to the public. If remediation is conducted as part of a RCRA corrective action, state regulatory agencies may require permits to be obtained before implementing the system. These may include a permit to operate the treatment system, a permit to store contaminated residuals (i.e., Sponges, regenerant solutions) for more than 90 days, and a wastewater discharge permit.

Requires minimal site preparation and utilities (water & electricity). \$ 238 per 1,000 gallons with Sponges regenerated twice providing for 3 useful cycles.^(*)

Significant portion of cost attributable to frequent replacement and regeneration due to limited absorption capacity for cadmium in this groundwater. Treatment costs can be seriously impacted by absorption capacity for the metals of concern.

* Actual cost of a remedial technology is site-specific and is dependent on factors such as the cleanup level, contaminant concentrations and types, waste characteristics, and volume necessary for treatment. Cost data presented in this table are for treating 525,000 gallons of heavy metal contaminated over a one year period. The groundwater is assumed to have similar waste characteristics to the demonstration groundwater with cadmium, copper, and lead treated to Developer claims utilizing a four column pump and treat unit similar to the demonstration, mobile trailer unit.

SECTION 1

INTRODUCTION

This section provides background information about the Superfund Innovative Technology Evaluation (SITE) Program, discusses the purpose of this Innovative Technology Evaluation Report (ITER), and describes the Dynaphore, Inc. Forager™ Sponge Technology. For additional information about the SITE Program, this technology, and the demonstration site, key contacts are listed at the end of this section.

1.1 Background

The Forager™ Sponge Technology was demonstrated under the SITE Program at the NL Industries, Inc. Superfund site in Pedricktown, New Jersey in April, 1994. The mobile, pump-and-treat system treated groundwater contaminated with heavy metals. The demonstration focused on the system's ability to remove cadmium, chromium, copper, and lead from the contaminated groundwater over a continuous 72-hour test. Based on field and laboratory treatability tests, the Developer claimed that the technology would achieve at least a 90% reduction of lead and copper, an 80% reduction of cadmium and a 50% reduction of chromium (as trivalent chrome) in the groundwater. This evaluation of the Dynaphore, Inc. Forager™ Technology is based primarily on the results of the SITE demonstration conducted at the NL Industries, Inc. site.

The Forager™ Sponge is an open-celled cellulose sponge incorporating an amine-containing chelating polymer that selectively absorbs dissolved heavy metals in both cationic and anionic states. This technology is a volume reduction technology in which heavy metal contaminants from an aqueous medium are concentrated into a smaller volume for facilitated disposal. The Developer states that the technology can be used to remove and concentrate heavy metals from a wide variety of aqueous media, such as groundwater, surface waters, and process waters. The sponge matrix can be directly disposed, or regenerated with chemical solutions.

1.2 Brief Description of Program and Reports

The SITE Program is a formal program established by the EPA's Office of Solid Waste and Emergency Response (OSWER) and Office of Research and Development (ORD) in response to the Superfund Amendments and Reauthorization Act of 1986 (SARA). The SITE Program promotes the development, demonstration, and use of new or innovative technologies to clean up Superfund sites across the country.

The SITE Program's primary purpose is to maximize the use of alternatives in cleaning hazardous waste sites by encouraging the development and demonstration of new, innovative treatment and monitoring technologies. It consists of four major elements:

- the Demonstration Program,
- the Emerging Technologies Program,
- the Monitoring and Measurement Technologies Program, and
- the Technology Transfer Program.

The objective of the Demonstration Program is to develop reliable performance and cost data on innovative technologies so that potential users may assess the technology's site-specific applicability. Technologies evaluated are either available commercially or close to being available for full-scale remediation of Super-fund sites. SITE demonstrations are conducted at hazardous waste sites under conditions that closely simulate full-scale remediation conditions, thus assuring the usefulness and reliability of information collected. Data collected are used to assess: (1) the performance of the technology; (2) the potential need for pre- and post-treatment processing of wastes; (3) potential operating problems; and (4) the approximate costs. The demonstrations also provide opportunities to evaluate the long term risk and limitations of the technologies.

The Emerging Technologies Program focuses on conceptually proven bench-scale technologies that are in an early stage of development involving pilot or laboratory testing. Successful technologies are encouraged to advance to the Demonstration Program

Existing technologies that improve field monitoring and site characterizations are identified in the Monitoring and Measurement Technologies Program. New technologies that provide faster, more cost-effective contamination and site assessment data are supported by this program. The Monitoring and Measurement Technologies Program also formulates the protocols and standard operating procedures for demonstration methods and equipment.

The Technology Transfer Program disseminates technical information on innovative technologies in the Demonstration, Emerging Technologies, and Monitoring and Measurements Technologies Programs through various activities. These activities increase the awareness and promote the use of innovative technologies for assessment and remediation at Superfund sites. The goal of technology transfer activities is to develop interactive communication among individuals requiring up-to-date technical information.

1.3 The SITE Demonstration Program

Technologies are selected for the SITE Demonstration Program through annual requests for proposals. ORD staff reviews the proposals to determine which technologies show the most promise for use at Superfund sites. Technologies chosen must be at the pilot- or full-scale stage, must be innovative, and must have some advantage over existing technologies. Mobile technologies are of particular interest.

Once the EPA has accepted a proposal, cooperative agreements between the EPA and the Developer establish responsibilities for conducting the demonstration and evaluating the technology. The Developer is responsible for demonstrating the technology at the selected site and is expected to pay any costs for transport, operation, and removal of the equipment. The EPA is responsible for project planning, sampling and analysis, quality assurance and quality control, preparing reports, disseminating information, and transporting and disposing of treated waste materials.

The results of this evaluation of the Dynaphore, Inc. Forager™ Technology for treatment of heavy metal contaminated aqueous waste are published in two basic documents: the SITE Technology Capsule and this Innovative Technology Evaluation Report. The SITE Technology Capsule provides relevant information on the technology, emphasizing key features of the results of the SITE field demonstration. Both the SITE Technology Capsule and the ITER are intended for use by remedial managers making a detailed evaluation of the technology for a specific site and waste.

1.4 Purpose of the Innovative Technology Evaluation Report (ITER)

This ITER provides information on the Dynaphore, Inc. Forager™ Sponge Technology and includes a comprehensive description of this demonstration and its results. The ITER is intended for use by EPA remedial project managers, EPA on-scene coordinators, contractors, and other decision-makers carrying out specific remedial actions. The ITER is designed to aid decision-makers in further evaluating specific technologies for further consideration as applicable options in a particular cleanup operation. This report represents a critical step in the development and commercialization of a treatment technology.

To encourage the general use of demonstrated technologies, the EPA provides information regarding the applicability of each technology to specific sites and wastes. The ITER includes information on cost and site-specific characteristics. It also discusses advantages, disadvantages, and limitations of the technology.

Each SITE demonstration evaluates the performance of a technology in treating a specific waste. The waste characteristics of other sites may differ from the characteristics of the treated waste. Therefore, a successful field demonstration of a technology at one site does not necessarily ensure that it will be applicable at other sites. Data from the field demonstration may require extrapolation for estimating the operating ranges in which the technology will perform satisfactorily. Only limited conclusions can be drawn from a single field demonstration.

1.5 Technology Description

The Forager™ Sponge is an open-celled cellulose sponge which contains a water-insoluble polyamide chelating polymer for the selective removal of heavy metals. The polymer is intimately bonded to the cellulose so as to minimize physical separation from the supporting matrix. The functional groups in the polymer (i.e., amine groups in the polymer backbone, and pendent carboxyl groups) provide selective affinity for heavy metals in both cationic and anionic states, preferentially forming coordination complexes with transition-group heavy metals (groups IB through VIII B of the Periodic Table). The order of affinity of the polymer for metals is influenced by solution parameters such as pH, temperature, and

total ionic content. The following affinity sequence for several representative ions is generally expected by Dynaphore:

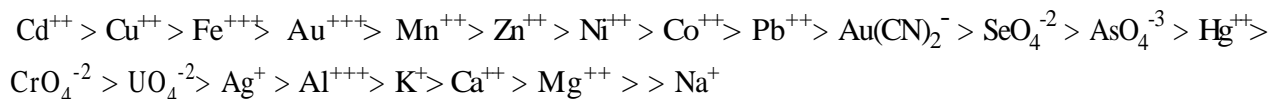

The high selectivity for heavy metals, and the low selectivity for alkali and alkaline earth metals (Na^+ , K^+ , Mg^{++} , and Ca^{++}), is especially useful for the treatment of contaminated natural waters which may contain high concentrations of these innocuous chemical species. These monovalent and divalent cations do not interfere with or compete with absorption of heavy metals, therefore allowing for maximum removal of heavy metals from contaminated waters

The Sponge is highly porous thereby promoting high rates of ion absorption. Absorbed ions can be eluted from the Sponge by techniques typically employed for regeneration of ion exchange resins. Following elution and washing, the Sponge is ready for the next absorption cycle. The useful life of the Sponge depends on the operating environment and the elution techniques used. Where regeneration is not desirable or economical, the Sponge can be compacted to a small volume to facilitate disposal. The metal-saturated Sponge can also be incinerated with careful attention given to the handling of resultant vapors.

The Sponge can be used in columns, fishnet-type enclosures, or rotating drums. For this demonstration, the Sponge was utilized in a series of four columns. Each column was comprised of a 1.7 cubic foot, pressurized acrylic tube containing about 24,000 half-inch Sponge cubes packaged within a removable fishnet bag. The columns were mounted on a mobile trailer unit.

Section 4.2 provides the specific details of the process design used during the Demonstration Test. Section 4.3 discusses the methodology behind the treatment and testing performed. Specific details regarding the polymer's configuration and removal chemistry are presented by the Developer in Appendix A.

1.6 Key Contacts

Additional information on the Dynaphore, Inc. Forager™ Sponge Technology and the SITE Program can be obtained from the following sources:

The Dynaphore, Inc. Forager™ Sponge Technology

Dr. Norman Rainer
Dynaphore, Inc.
2709 Willard Road
Richmond, VA 23294
Phone: 804/288-7109
Fax: 804/282- 1325

The SITE Program

Robert A. Olexsey, Director
Superfund Technology Demonstration Division
U.S. Environmental Protection Agency
26 West Martin Luther King Drive
Cincinnati, Ohio 45268
Phone: 513/569-7861
Fax: 513/569-7620

Carolyn Esposito
EPA SITE Technical Project Manager
U.S. Environmental Protection Agency
2890 Woodbridge Avenue (MS- 106)
Edison, New Jersey 08837-3679
Phone: 908/906-6895
Fax: 908/906-6990

Information on the SITE Program is available through the following on-line information clearinghouses:

- The Alternative Treatment Technology Information Center (ATTIC) System (operator: 703/908-2137) is a comprehensive, automated information retrieval system that integrates data on hazardous waste treatment technologies into a centralized, searchable source. This data base provides summarized information on innovative treatment technologies.
- The Vendor Information System for Innovative Treatment Technologies (VISITT) (hotline: 800/245-4505) data base currently contains information on approximately 231 technologies offered by 141 Developers.
- The OSWER CLU-In electronic bulletin board contains information on the status of SITE technology demonstrations. The system operator can be reached at 301/585-8368.

Technical reports may be obtained by contacting the Center for Environmental Research Information (CERI), 26 West Martin Luther King Drive in Cincinnati, Ohio, 45268 at 513/569-7562.

SECTION 2

TECHNOLOGY APPLICATIONS ANALYSIS

This section of the report addresses the general applicability of the Dynaphore, Inc. Forager™ Sponge Technology to contaminated waste sites. The analysis is based primarily on the results of this SITE demonstration since limited information is available on other applications of the technology. SITE demonstration results are presented in Section 4. The vendor's claims regarding the applicability and performance of the Forager™ Sponge technology are presented in Appendix A.

2.1 Key Features of the Dynaphore, Inc. Forager* Sponge Technology

The Forager™ Sponge Technology incorporates a specialty chelating polymer that has a selective affinity for removing heavy metals from aqueous media. The polymer preferentially binds toxic heavy metals over common aqueous constituents such as Ca^{++} , Mg^{++} , K^{+} , and Na^{+} . The Sponge's low affinity for these monovalent and divalent cations allows these ions, for the most part, to pass through the treatment system, enabling maximum absorption of the toxic heavy metals even in the presence of higher concentrations of these innocuous species. The selective affinity of the polymer is similar to commercially available chelating resins; however, the Sponge's unique supporting cellulosic matrix may provide the technology with distinct advantages under certain processing conditions.

The Forager™ Sponge could potentially be incorporated into varied treatment configurations. The technology can be utilized in a conventional pump-and-treat remedial process, as was performed during the SITE Demonstration. According to the Developer, the Sponge also can be used in applications requiring in-situ treatment. In-situ applications, however, were not evaluated for this demonstration nor has the Developer commercially utilized the technology in such applications. For in-situ applications, the Developer reports that the Sponge, contained within fishnet bags, could be placed within trenches or wells to intercept an existing flow of water (e.g., groundwater or acid mine drainage). The Sponge reportedly could also be used to treat surface waters by placing the Sponge in a fishnet configuration across channels or within other surface water bodies.

In addition to potential different treatment applications, the Sponge's matrix provides advantages in terms of disposal and operating conditions. The high porosity of the Sponge enables a low pressure

system to be used. For this demonstration, the four column unit operated under an inlet pressure as low as 4.4 psig. With sufficient head the system could have operated by gravity flow, but this was not demonstrated. The metal-laden Sponge can also be compacted into small disposal volumes, which could aid in lowering disposal costs; this is particularly beneficial when minimal residual waste is required due to the properties of the contaminants being absorbed. For example, this may be advantageous in the treatment of radiologically contaminated waters, where the need to minimize the volume of residual waste is a critical disposal issue.

2.2 Operability of the Technology

The Forager™ Sponge Technology was utilized in a pump-and-treat mode. The treatment system employed consisted of a series of four 1.7 cubic foot columns situated on a mobile, open trailer-mounted unit measuring approximately 50 square feet. Each column measures 5 feet in height with an 8 inch inside diameter. The columns are connected for upward series flow. Each column contains a removable fishnet bag which is filled with approximately 24,000 half-inch Sponge cubes. The trailer is equipped with a wastewater pump, water heater, and both a rotameter and positive displacement type flow totalizer. These flow meters are installed on the outlet line of the unit. The system is operated by trained personnel and may be operated unattended until replacement and/or regeneration of the Sponges is required. The Forager™ Sponge unit appeared to be free of operational problems during the demonstration in Pedricktown, NJ.

Since reaction kinetics are an important factor in the metal removal efficiency of the Sponge, both flow and temperature are key operating parameters which influence the performance of the Forager™ Sponge Technology. Based on treatability tests conducted on the groundwater the Developer determined that optimum removal efficiency, utilizing the system employed, would be achieved at a flow rate of 1 gpm or .08 bed volumes per minute. Additionally, to ensure optimum conditions, the Developer increased the groundwater temperature approximately 14° C from 17° C to 31° C. The optimum flow rate and the need to increase water temperature is dependent upon the waste treated and the removal efficiencies required, as well as the number of Sponge columns employed.

Both flow and temperature were continually monitored during the demonstration. Temperature gauges were installed on the inlet and outlet of the water heater. As stated earlier, a rotameter and volume

totalizer were situated on the trailer. However, due to the physical location of the meters, air bubbles in the treated groundwater passing through the meters influenced the reliability of the measurements. A digital flowmeter provided by the EPA for the demonstration was substituted and installed on the outlet line to the treated storage tank where its physical location was not influenced by air bubbles. Based on experience from the SITE demonstration, the Developer may need to relocate his flow meters and/or utilize a meter(s) less influenced by air bubbles.

Replacement and/or regeneration of the Sponges within the columns is necessary when Sponges become saturated and/or operate below a desired removal efficiency. According to the Developer, replacement and/or regeneration was not required for the demonstration, since none of the columns of Sponges were anticipated to be saturated. However, as to be discussed in Section 4, although the Developer was able to meet his treatment claims, some of the Sponge columns became saturated during the demonstration. For the four column system utilized, the system would be shut down to allow for replacement or regeneration of the Sponges. Once put back on line, a regenerated or new Sponge column would then become the last column, with all remaining columns moving up the treatment line. This is easily accomplished through the wastewater piping design which provides for manifolding of the columns. Raw influent flow can be redirected by valving to any of the columns.

Replacement of the Sponges can be easily performed within a one hour period. Each column has a lid secured with eight bolts and contains a removable fishnet container (bag) filled with Sponge cubes. Following removal of the lid, the fishnet container is removed from the column via an overhead pulley system mounted on the trailer. The containers of Sponges are lifted out and suspended over the columns to allow any residual water to drain back into the columns. Once sufficiently drained, plastic sleeves (bags) are placed over the fishnet bags of Sponges. The Sponges are then ready for disposal. The Developer reports that he will be replacing the bolted lid design with a quick-release, bayonet-type fitting, which will allow for easier and faster removal of the column lids. The Sponges can be hand compacted into 55-gallon drums, as was performed for the demonstration. By laying the Sponges horizontally and bending into a horseshoe shape within the drum, four fishnet bags of Sponges could be laid on top of each other. Additional compaction could be achieved through the use of a waste compactor. However, if a waste compactor is used, provisions may have to be in place to collect any residual water which would be squeezed from the Sponges during compaction. Any water collected could be recycled to the treatment system.

As stated, regeneration of the Sponges was not conducted for the demonstration. Regeneration of small test columns with standard solutions of critical metals was performed to evaluate the Sponge's regenerative capabilities (see Section 4). After the demonstration, the Developer conducted regeneration tests on Sponge cubes taken from the columns. These tests showed regeneration of the Sponge is feasible. For the 1.7 cubic foot columns used, the Developer reports that regeneration can be accomplished by slowly running 34 quarts of 10% industrial grade hydrochloric acid (HCl) at 1 quart/minute through a column Sponge followed by a water wash with 34 quarts of potable water at 1 quart/minute. The acid and water wash is pumped through the top of the column from a 30 gallon tank located on the trailer. The trailer unit is also equipped with a pump to feed regenerant chemicals automatically to the columns. The Developer also noted that heating of the HCl to 40° C may be desirable to improve metals recovery or to permit the use of less concentrated acid. If heating is not feasible, the Developer suggests retaining the HCl in the column for a two to four hour period.

2.3 Applicable Wastes

The Forager™ Sponge Technology is suitable for dissolved heavy metals in both cationic and anionic states. The Developer reports that the Forager™ Sponge can be utilized to remove and concentrate heavy metals in the parts per billion (ppb) and parts per million (ppm) range from a wide variety of contaminated aqueous media such as groundwater, surface water, landfill leachate, industrial effluent, and acid mine drainage. For this demonstration the technology was successful in treating groundwater with heavy metals in the ppb range. The technology was able to achieve ≥89% reduction of lead, cadmium, and copper in concentrations ranging from 500 to 900 ppb. The Sponge may also be effective for radioactive or mixed waste (radioactive and hazardous waste) since it reportedly has a strong affinity for radioactive isotopes such as uranium. This, however, was not evaluated for the demonstration. Although present in the groundwater, the levels of alpha and beta radioactivity were too low to conclusively determine the technology's effectiveness. As stated in Section 2.2, the ability to compact the Sponge to small volumes is particularly advantageous for radiologically contaminated waters

The Sponge's high selectivity for toxic heavy metals and the low selectivity for monovalent and other divalent cations (i.e., Na⁺, K⁺, Mg²⁺, and Ca²⁺) is especially useful for the treatment of contaminated natural waters which may contain high concentrations of these innocuous chemical species. These cations do not interfere with or compete with absorption of the toxic heavy metals. This was supported by the

demonstration results which showed effective removal of the lead, cadmium, and copper in the presence of disproportionately higher concentrations of calcium, magnesium, aluminum, sodium and potassium. Concentrations of these cations ranged from 70 mg/L for magnesium to 6000 mg/L for sodium with virtually no removal occurring.

The Forager™ Sponge can be utilized in a conventional pump-and-treat remedial process as either the primary or secondary removal mechanism, depending upon the type and concentration of contaminants as well as the properties of the wastewater. For example, the Sponge may be used as a polishing step in conjunction with a technology that can reduce high concentrations of metals to moderate levels (e.g., chemical precipitation). As discussed in Section 2.1, the Sponge could also potentially be used for in-situ applications. However, there is insufficient information to properly evaluate the viability of in-situ applications.

The Developer reports that the Sponge is effective over a wide pH range of 2 to 11. The pH of the groundwater treated in the demonstration ranged from 3.1 to 3.8. The Developer reports little or no pretreatment is required for the technology. TSS levels as high as 100 mg/L do not impact the Sponge performance as shown by the demonstration. TSS levels for the demonstration ranged from 85 mg/L to 107 mg/L. Also, according to the Developer, oil and grease also do not impact the Sponge unless the water contains a significant oily layer. Organics also reportedly do not foul the system.

2.4 Availability and Transportability of Equipment

The Forager™ Sponge treatment unit is mounted on a flat-bed trailer and is easily transported. Once on site, the treatment system can be in operation within a day if all necessary facilities, utilities, and supplies are available. On site assembly and maintenance requirements are minimal.

Demobilization activities include decontaminating on-site equipment (if necessary), disconnecting utilities, disassembling equipment, and transporting equipment off-site. Demobilization requires approximately one day for the Forage™ Sponge unit.

2.5 Materials Handling Requirements

If the Forager™ Sponge Technology is utilized to treat groundwater in a pump and treat approach, a groundwater recovery well(s) will need to be installed. Boreholes for wells are installed using a drill rig. Drilling services are generally subcontracted to a company which has both the required equipment (drill rigs, augers, samplers) and personnel trained in drilling operations and well construction. Drilling personnel must have OSHA-required 40-hour health and safety training, if work is performed at a hazardous waste site. Once all of the well(s) are drilled and developed, each must be equipped with a pump to supply the feed water to the system. An equalization tank may be required to store the feed water rather than pumping directly to the unit. Additionally, if the treated water is temporarily stored prior to disposal (e.g., for testing), a suitably sized storage tank will be needed, including an effluent pump to transport treated water from the unit to the tank. All pumps chosen must be able to perform under harsh conditions, high solids content (both total and dissolved), corrosive pH, and variable chemical composition and concentrations. These factors should be taken into account during the selection of pumps and ancillary equipment such as hoses and fittings.

As stated in Section 2.3, the Developer reports little or no pretreatment is required for the technology unless appreciable amounts of solids or oils are present. Waters containing a visible oily layer will require pretreatment to remove the oil. An oil/water separator should be sufficient to reduce the oil content to an acceptable level. Pretreatment for removal of suspended solids may be required if a significant concentration of suspended matter is present which could plug the Sponge pores. Depending on the concentration, a simple bag filter or cartridge filter may be sufficient.

The residuals generated from the Sponge technology consist of solid sponge material and liquid (acid) regenerant solution, if regeneration is performed. These residuals will be concentrated with heavy metals, and depending on contaminant levels, may be subject to RCRA regulations as a hazardous waste. These waste materials can be easily stored in appropriate 55-gallon drums for off-site transport and disposal. For the demonstration, four fishnet bags of Sponges were hand compacted into one 55-gallon drum. Further compaction is possible utilizing a waste compactor. Following completion of the demonstration, the Developer sent four fishnet bags of virgin Sponges to a waste compacting firm to determine maximum compaction achievable. Tests performed revealed compaction ratios of 4:1 and 10:1 utilizing compaction forces of 20,000 pounds and 85,000 pounds, respectively. Based on these

compaction ratios, using 20,000 pounds of compaction force, approximately 16 bags of Sponges could be disposed within a 55-gallon drum, and at 85,000 pounds of force approximately 40 bags of Sponges could be disposed in one 55-gallon drum.

Depending on discharge limitations, treated water may be discharged into a POTW or surface water body, or may be reinjected into the ground. For the demonstration, the treated water was collected in a storage tank for transport to a local POTW for treatment.

2.6 Range of Suitable Site Characteristics

Locations suitable for on-site treatment using the Forager™ Sponge Technology trailer unit must be able to accommodate and/or provide utilities, support facilities, and support equipment. These requirements are discussed below.

Utilities required for the Forager™ Sponge unit are limited to water and electricity. Electricity requirements for the trailer unit are dependent upon the need to pump, rather than gravity feed the wastewater through the columns; and the need to heat the wastewater to improve absorption of heavy metals and/or the HCl for regeneration, if necessary (see Section 2.2). The water heater utilized in the system requires a single phase 220-volt electrical circuit. If gravity feed is not feasible, the water can be pumped with a 12-volt pump installed on the trailer. This pump can also run off a car battery, as was done for the demonstration. Other than the trailer unit, electricity may be required for running any ancillary pump, building and outdoor lights, and on-site office trailers. Water will be required occasionally for regeneration of the Sponges, cleanup, and decontamination.

Support facilities include an area for untreated and treated groundwater storage tanks (if used), a chemical storage area for regenerant chemicals (i.e., acids) and any other process chemicals, and a waste drum storage area for spent Sponges, spent regenerant solutions, and other wastes requiring disposal. These support areas must be constructed with a secondary containment system (e.g., concrete berm) to control runoff and runoff. Additionally, an enclosed building or shed may be necessary to protect equipment and personnel from weather extremes. This shed should be heated and used to house the Sponge technology. Also, if below-freezing temperatures are anticipated for extended periods of time, influent and effluent storage tanks and transfer lines may need to be insulated or also kept in the shed.

During the demonstration, the treatment unit was housed in a tent measuring approximately 400 square feet. Mobile trailers may be used as office space on site. These office trailers must be located outside the treatment/contaminated area.

Support equipment for the Forager™ Sponge Technology may include a drill rig for well installation, containers for waste storage, a forklift for moving waste drums, and a waste compactor for compaction of Sponges. In addition to an influent equalization tank, a treated effluent storage tank may be needed if the water cannot be directly discharged to a POTW or surface water body or reinjected into the ground.

2.7 Limitations of the Technology

The technology is considered a volume reduction technology since the contaminants are removed from the waste stream and concentrated into a smaller volume which can be more easily handled and disposed. The reduced volume, either Sponge material or acid regenerant solution, must be immobilized by other means on-site or off-site. A Toxicity Characteristic Leaching Procedure (TCLP) was not performed on metal-saturated Sponges for the demonstration. Although the Sponge is regenerated with hydrochloric acid (which is stronger than acetic acid used in the TCLP test), it is not anticipated that the Sponge would pass a TCLP test for disposal as non-hazardous waste, assuming sufficient quantities of RCRA-regulated heavy metals are absorbed on the Sponge. The Developer, however, does report that bench-scale laboratory tests have shown that the metal-saturated Sponge cubes, when treated with certain fixatives, such as a phenol-formaldehyde resin, will pass the TCLP test for metals.

According to the Developer, the scope of contaminants suitable for treatment using the Forager™ Sponge Technology is limited to certain heavy metals. This SITE demonstration was conducted to evaluate the performance of the technology with respect to cadmium, chromium, copper and lead. The behavior of other heavy metals present was noted during the demonstration and therefore, data regarding the removal (or lack of removal) of these species are also presented in this report.

The technology's affinity and absorption capacity for given metals can vary and appears to be dependent on a number of waste characteristics including pH, concentrations and types of cations and anions present, and the presence of complexing agents. As an example, the technology had a unusually

poor affinity for iron. The Developer believes that this may have been caused by organosulfur compounds which strongly complexed with the iron and thus interfered with the Sponge's removal ability. The Developer has also theorized that the lower-than-expected saturation levels for the critical metals (cadmium, chromium, copper, and lead) may have been caused by the presence of anion species such as sulfate, phosphate, silicate, and vanadate. These anion species are believed to have reacted with the calcium present in the starting Sponge, thereby binding the calcium on the Sponge in a chemical form that prevented its effective exchange for the metals of concern. The Developer believes that a modified polymer or a preactivation step with hydrochloric acid might have improved the polymer's capacity (see Appendix A - Vendor's Claims). It should be noted that an adverse behavior due to commonly encountered anions, such as sulfate and phosphate, could have a serious impact on the Sponge's absorption capacity.

Regardless of the reasons for the decreased capacity, the technology's usefulness may be severely limited by its overall absorption capacity for the heavy metals of concern. If frequent changeout or regeneration of the Sponges is required, it could make this technology cost prohibitive. In these applications, pretreatment may be necessary in order to reduce the concentration of specific contaminants to technically and/or economically optimal levels. The results of the demonstration have shown that future use of the technology would require the Developer to conduct treatability tests on each waste stream proposed for treatment to determine the true absorption capacity of the system. The Developer's estimates on absorption capacity were based on laboratory absorption tests performed on heavy metal standard solutions rather than the groundwater. As stated, the demonstration results revealed that the actual absorption capacity for the critical metals was significantly lower than the Developer's estimates.

2.8 ARARS for the Dynaphore, Inc. Forager™ Sponge Technology

This subsection discusses specific federal environmental regulations pertinent to the operation of the Forager™ Sponge Technology including the transport, treatment, storage, and disposal of wastes and treatment residuals. These regulations are reviewed with respect to the demonstration results. State and local regulatory requirements, which may be more stringent, must also be addressed by remedial managers. Applicable or relevant and appropriate requirements (ARARs) include the following: (1) the Comprehensive Environmental Response, Compensation, and Liability Act; (2) the Resource Conservation and Recovery Act; (3) the Clean Water Act; (4) the Safe Drinking Water Act; (5) the Occupational Safety

and Health Administration regulations; (6) radioactive waste regulations; and (7) mixed waste regulations. These seven general ARARs are discussed below; specific ARARs that may be applicable to the Dynaphore Inc. Forager™ Sponge Technology are identified in Table 2-1.

2.8.1 Comprehensive Environmental Response, Compensation, and Liability Act (CERCLA)

The CERCLA of 1980 as amended by the Superfund Amendments and Reauthorization Act (SARA) of 1986 provides for federal funding to respond to releases or potential releases of any hazardous substance into the environment, as well as to releases of pollutants or contaminants that may present an imminent or significant danger to public health and welfare or to the environment.

As part of the requirements of CERCLA, the EPA has prepared the National Oil and Hazardous Substances Pollution Contingency Plan (NCP) for hazardous substance response. The NCP is codified in Title 40 Code of Federal Regulations (CFR) Part 300, and delineates the methods and criteria used to determine the appropriate extent of removal and cleanup for hazardous waste contamination.

SARA states a strong statutory preference for remedies that are highly reliable and provide long-term protection and directs EPA to do the following:

- use remedial alternatives that permanently and significantly reduce the volume, toxicity, or mobility of hazardous substances, pollutants, or contaminants;
- select remedial actions that protect human health and the environment, are cost-effective, and involve permanent solutions and alternative treatment or resource recovery technologies to the maximum extent possible; and
- avoid off-site transport and disposal of untreated hazardous substances or contaminated materials when practicable treatment technologies exist [Section 121(b)].

In general, two types of responses are possible under CERCLA: removal and remedial action. The Dynaphore Inc. Forager™ Sponge Technology is likely to be part of a CERCLA remedial action.

TABLE 2-1. FEDERAL AND STATE ARARs FOR THE DYNAPHORE, INC. FORAGER™ SPONGE TECHNOLOGY

PROCESS ACTIVITY	ARAR	DESCRIPTION	BASIS	RESPONSE
Waste Characterization (untreated waste)	RCRA 40 CFR Part 261 or state equivalent ¹	Standards that apply to identification and characterization of waste to be treated	A requirement of RCRA prior to managing and handling the waste	Chemical analyses must be performed
Waste processing	RCRA 40 CFR Part 264 and 265 or state equivalent ¹	Standards applicable to the treatment of hazardous waste at permitted and interim status facilities	Treatment of hazardous waste must be conducted in a manner that meets the operating and monitoring requirements	Equipment must be maintained daily. Integrity of treatment unit and influent and effluent storage tanks, if used, must be monitored and maintained to prevent leakage or failure
Storage after processing	RCRA 40 CFR Part 264 and 265 subpart I or state equivalent ¹	Standards that apply to the storage of hazardous waste in containers .	The process residuals, including spent Sponges and regenerant solution may be deemed hazardous	Process residuals must be stored in appropriate containers in good condition. Containers should be stored in designated hazardous waste storage area with proper secondary containment.
Waste characterization (process residuals)	RCRA 40 CFR Part 261, or state equivalent ¹	Standards that apply to waste characteristics	A requirement of RCRA prior to managing and handling the waste; it must be determined if treated material is RCRA hazardous waste and/or mixed waste	Chemical and physical analyses must be performed on process residual wastes prior to disposal

22

TABLE 2-1 FEDERAL AND STATE ARARs FOR THE DYNAPHORE, INC. FORAGER™ SPONGE TECHNOLOGY

PROCESS ACTIVITY	ARAR	DESCRIPTION	BASIS	RESPONSE
On-site/off-site disposal	RCRA 40 CFR Part 268 or state equivalent ⁽⁺⁾	Standards that apply to the disposal of hazardous waste	The nature of the waste may be subject to disposal restrictions.	Treated process residuals defined as hazardous must be disposed of at a permitted hazardous waste facility, or approval must be obtained from the lead regulatory agency to dispose of the wastes on site.
	SARA Section 121 (d)(3)	Requirements for the off-site disposal of wastes from a Superfund site	The waste is being generated from a response action authorized under SARA	Wastes must be disposed of at a RCRA permitted hazardous waste facility
Transportation for off-site disposal	RCKA 40 Part 262 or state equivalent ⁽⁺⁾	Manifest requirements and packaging and labeling requirements prior to transporting	Process residuals may need to be manifested and managed as a hazardous waste	An identification (ID) number must be obtained from EPA
	RCRA 40 CFR Part 263 or state equivalent ⁽⁺⁾	Transportation standards	Treated wastes and/or oversize material may need to be transported as hazardous waste	A transporter licensed by EPA must be used to transport the hazardous waste according to EAP regulations

TABLE 2-1 FEDERAL AND STATE ARARs FOR THE DYNAPHORE, INC. FORAGER™ SPONGE TECHNOLOGY

PROCESS ACTIVITY	ARAR	DESCRIPTION	BASIS	RESPONSE
Wastewater discharge	Clean Water Act 40 CFR Parts 301, 304, 306, 307, 308, 402, and 403	Standards that apply to discharge of wastewater into POTWs or surface water bodies	The wastewater may be hazardous waste	Determine if wastewater could be directly discharged into a POTW or surface water body. If not, the wastewater may need to be further treated to meet discharge requirements by conventional processes. An NPDES permit may be required for discharge to surface waters
	Safe Drinking Water Act 40 CFR Parts 144 and 145	Standards that apply to the disposal of contaminated water in underground injection wells	Wastewater may require disposal in underground injection wells	If underground injection is selected as a disposal means for contaminated wastewater, permission must be obtained EPA to use existing permitted underground injection wells or to construct and operate new wells

Notes: (+) = Activities may also be subject to DOE, NRC, and AEA regulations or directives for treatment, storage and disposal of radioactive or mixed wastes, if these wastes are treated

Remedial actions are governed by the SARA amendments to CERCLA. As stated above, these amendments promote remedies that permanently reduce the volume, toxicity, and mobility of hazardous substances, pollutants, or contaminants. The Dynaphore Forager™ Sponge Technology is a volume reduction technology as it transfers aqueous heavy metal contaminants from one media to a smaller concentrated contaminant volume.

On-site remedial actions must comply with federal and more stringent state ARARs. ARARs are determined on a site-by-site basis and may be waived under six conditions: (1) the action is an interim measure, and the ARAR will be met at completion; (2) compliance with the ARAR would pose a greater risk to health and the environment than noncompliance; (3) it is technically impracticable to meet the ARAR, (4) the standard of performance of an ARAR can be met by an equivalent method; (5) a state ARAR has not been consistently applied elsewhere; and (6) ARAR compliance would not provide a balance between the protection achieved at a particular site and demands on the Superfund for other sites. These waiver options apply only to Superfund actions taken on site, and justification for the waiver must be clearly demonstrated.

2.8.2 Resource Conservation and Recovery Act (RCRA)

RCRA, an amendment to the Solid Waste Disposal Act (SWDA), is the primary federal legislation governing hazardous waste activities and was passed in 1976 to address the problem of how to safely dispose of the enormous volume of municipal and industrial solid waste generated annually. Subtitle C of RCRA contains requirements for generation, transport, treatment, storage, and disposal of hazardous waste, most of which are also applicable to CERCLA activities. The Hazardous and Solid Waste Amendments (HSWA) of 1984 greatly expanded the scope and requirements of RCRA.

RCRA regulations define hazardous wastes and regulate their transport, treatment, storage, and disposal. These regulations are only applicable to the Dynaphore Forager™ Sponge Technology if RCRA defined hazardous wastes are present. Potential hazardous wastes include the aqueous waste to be treated, spent Sponges, and eluted solutions from regeneration. If these wastes are determined to be hazardous according to RCRA (primarily due to heavy metal content), all RCRA requirements regarding the management and disposal of this hazardous waste will need to be addressed by the remedial managers. Wastes defined as hazardous under RCRA include characteristic and listed wastes. Criteria for identifying

characteristic hazardous wastes are included in 40 CFR Part 261 Subpart C. Listed wastes from specific and nonspecific industrial sources, off-specification products, spill cleanups, and other industrial sources are itemized in 40 CFR Part 261 Subpart D. For this demonstration, the groundwater to be treated, although not hazardous, did contain lead, cadmium, and chromium which, depending on concentrations, could be D-listed RCRA wastes. Since the technology would be transferring and concentrating these metals to the Sponge matrix, the spent Sponges were handled as a hazardous waste, under a conservative approach. Contaminated personal protective equipment (PPE) is subject to land disposal restriction (LDR) under both RCRA and CERCLA only if it contains more than 5% contamination per square inch.

For generation of any hazardous waste, the site responsible party must obtain an EPA identification number. Other applicable RCRA requirements may include a Uniform Hazardous Waste Manifest (if the waste is transported), restrictions on placing the waste in land disposal units, time limits on accumulating waste, and permits for storing the waste.

Requirements for corrective action at RCRA-regulated facilities are provided in 40 CFR Part 264, Subpart F (promulgated) and Subpart S (partially promulgated). These subparts also generally apply to remediation at Superfund sites. Subparts F and S include requirements for initiating and conducting RCRA corrective action, remediating groundwater, and ensuring that corrective actions comply with other environmental regulations. Subpart S also details conditions under which particular RCRA requirements may be waived for temporary treatment units operating at corrective action sites and provides information regarding requirements for modifying permits to adequately describe the subject treatment unit,

2.8.3 Clean Water Act (CWA)

The objective of the Clean Water Act is to restore and maintain the chemical, physical and biological integrity of the nation's waters by establishing federal, state, and local discharge standards. If treated water is discharged to surface water bodies or publicly-owned treatment works (POTW), CWA regulations will apply. A facility desiring to discharge water to a navigable waterway must apply for a permit under the National Pollutant Discharge Elimination System (NPDES). When a NPDES permit is issued, it includes waste discharge requirements. Discharges to POTWs must comply with general pretreatment regulations outlined in 40CFR Part 403, as well as other applicable state and local administrative and substantive requirements.

Treated effluent from the SITE demonstration was considered acceptable for treatment at a local POTW. Since the technology is only effective for selected heavy metals, additional treatment methods would probably be necessary for discharge to a surface water body. Depending on the NPDES permit limits and the influent quality of the water treated, further treatment could include pH adjustment, solids reduction (i.e., TSS and TDS), reducing temperature (especially if a water heater is used), and detoxification of organic compounds, if present.

2.8.4 Safe Drinking Water Act (SDWA)

The SDWA of 1974, as most recently amended by the Safe Drinking Water Amendments of 1986, requires the EPA to establish regulations to protect human health from contaminants in drinking water. The legislation authorized national drinking water standards and a joint federal-state system for ensuring compliance with these standards.

The National Primary Drinking Water Standards are found in 40 CFR Parts 141 through 149. Parts 144 and 145 discuss requirements associated with the underground injection of contaminated water. If underground injection of wastewater is selected as a disposal means, approval from EPA for constructing and operating a new underground injection well is required.

2.8.5 Occupational Safety and Health Administration (OSHA) Requirements

CERCLA remedial actions and RCRA corrective actions must be performed in accordance with the OSHA requirements detailed in 20 CFR Parts 1900 through 1926, especially Part 1910.120 which provides for the health and safety of workers at hazardous waste sites. On-site construction activities at Superfund or RCRA corrective action sites must be performed in accordance with Part 1926 of OSHA, which describes safety and health regulations for construction sites. State OSHA requirements, which may be significantly stricter than federal standards, must also be met.

All technicians operating the Forage™ Sponge Technology and all workers performing on-site construction are required to have completed an OSHA training course and must be familiar with all OSHA requirements relevant to hazardous waste sites. For most sites, minimum PPE for workers will include gloves, steel-toe boots, and Tyvek® coveralls. Depending on contaminant types and concentrations,

additional PPE may be required. Noise levels are not expected to be high, however noise from the pumps driving the system will be constant, so noise levels should be monitored to ensure that workers are not exposed to noise levels above a time-weighted average of 85 decibels over an eight-hour day. If noise levels increase above this limit, then workers will be required to wear hearing protection. The levels of noise anticipated are not expected to adversely affect the community.

2.8.6 Radioactive Waste Regulations

The Forage™ Sponge Technology reportedly has the ability to treat water contaminated with radioactive materials. The primary agencies that regulate the cleanup of radioactively contaminated sites are EPA, Nuclear Regulatory Commission (NRC), the Department of Energy (DOE), and the states. In addition, nongovernmental agencies may issue advisories or guidance, which should also be considered in developing protective remedy.

The SDWA has established maximum contaminant levels (MCLs) for alpha and beta-emitting radionuclides which would be appropriate in setting cleanup standards for radioactively contaminated water. Discharge of treated effluent from the Forage™ Sponge technology could be subject to radionuclide concentration limits established in 40 CFR Part 440 (Effluent Guidelines for Ore Mining and Dressing). These regulations include effluent limits for facilities that extract and process uranium, radium, and vanadium ores.

NRC regulations cover the possession and use of source, by-product, and special nuclear materials by NRC licenses. These regulations apply to sites where radioactive contamination exists, and cover protection of workers and public from radiation, discharges of radionuclides in air and water, and waste treatment and disposal requirements for radioactive waste. In evaluating requirements for treating radiologically contaminated waters, consideration must not only be given to the quality of the raw water and final effluent, but any process residuals, specifically spent Sponges. If the technology is effective for radionuclides, these radioactive contaminants will be concentrated on the Sponge matrix. This could have an impact on disposal requirements, as well as health and safety considerations.

DOE requirements are included in a series of internal DOE orders that have the same force as regulations at DOE facilities. DOE orders address exposure limits for the public, concentration or residual radioactivity in soil and water, and management of radioactive wastes.

2.8.7 Mixed Waste Regulations

Use of the Forage™ Sponge Technology at sites with radioactive contamination may involve the treatment or generation of mixed waste. As defined by Atomic Energy Act (AEA) and RCRA, mixed waste contains both radioactive and hazardous components and is subject to both acts. When the application of both regulations results in a situation inconsistent with the AEA (for example, an increased likelihood of radioactive exposure), AEA requirements supersede RCRA requirements.

EPA's Office of Solid Waste and Emergency Response (OSWER), in conjunction with the NRC, issued several directives to assist in the identification, treatment, and disposal of low-level radioactive mixed waste. If high-level mixed waste or transuranic mixed waste is treated, DOE internal orders should be considered when developing a protective remedy.

SECTION 3

ECONOMIC ANALYSIS

This section presents cost estimates for operating the Dynaphore, Inc. Forager™ Sponge Technology in the remediation of heavy metal contaminated groundwater. With realistic costs and a knowledge of the bases for their determination, it should be possible to estimate the economics for operating similar-sized units as well as larger systems at other sites utilizing various scale-up approaches and cleanup scenarios.

This economic analysis is based on assumptions and costs provided by Dynaphore, Inc. and on results and experiences from this SITE demonstration developed over a 72-hr period of operation at 1 gallon per minute (gpm). The costs associated with treatment by the Forager™ Sponge treatment system, as presented in this economic analysis, are defined by 12 cost categories that reflect typical cleanup activities encountered on Superfund sites. Each of these cleanup activities is defined and discussed, forming the basis for the estimated cost analysis presented. Certain actual or potential costs were omitted because site-specific engineering aspects beyond the scope of this SITE project would be required. Certain other functions were assumed to be the obligation of the responsible parties and/or site owners and also were not included in the estimates. Cost figures provided here are “order-of-magnitude” estimates, generally +50%/-30%.

3.1 Conclusions of Economic Analysis

The estimated cost for the treatment of heavy metal contaminated groundwater for a one year period is presented in Table 3.1. This estimate assumes cadmium, lead, and copper are the contaminants of concern and that they are treated to demonstration performance claims utilizing a four column pump-and-treat unit similar to the demonstration trailer unit.

The economic analysis evaluated two different operating scenarios. The first scenario assumes that the Sponges can only be used once and are replaced upon saturation, while the second assumes the Sponges can be regenerated twice providing for a useful life of three treatment cycles. The frequency of regeneration and replacement was based on the saturation rate of cadmium, since demonstration results revealed that cadmium saturated the Sponge the quickest compared to lead and copper. A graphical

**TABLE 3-1 ESTIMATED COST FOR TREATMENT USING THE
DYNAPHORE, INC. FORAGER™ TECHNOLOGY'**

COST CATEGORY	ESTIMATED COST (\$)	
	REPLACEMENT ^b	REGENERATION ^c
1. Site Preparation		
Well drilling & preparation	2,000	2,000
Enclosure & pad	10,000	10,000
Groundwater pump & piping	3,000	3,000
6,500 gal tank	11,000	11,000
Total Costs	26,000	26,000
2. Permitting & Regulatory Requirements	N/A	N/A
3. Capital Equipment (1 gpm unit amortized over 10 yr)	2,500	2,500
4. Startup	250	250
6. Consumables & Supplies		
Sponges	101,910	33,970
HCL (regeneration)	0	2022
H & S gear	500	500
Maintenance supplies	50	50
Waste storage drums	5250	5250
Plastic sleeves	240	80
Total Costs	107,950	41,872
6. Labor		
Operator	14,910	24,390
Jr. Operator	3318	7742
Total Costs	18,228	32,132

COST CATEGORY	ESTIMATED COST (\$)	
	REPLACEMENT ^b	REGENERATION ^c
7. Utilities		
Electricity (water heater)	1,730	1,730
Enclosure (heat/lights)	1,000	1,000
Total Costs	2,730	2,730
8. Effluent Treatment & Disposal Costs	N/A	N/A
9. Residuals & Waste Shipping & Handling,		
Sponge	20,825	7,000
Liquid (regeneration)	0	12,209
Total Costs	20,825	19,209
10. Analytical Services	N/A	N/A
11. Maintenance & Modifications	N/A	N/A
12. Demobilization	N/A	N/A
TOTAL COST	178,483	124,693
TOTAL COST PER 1,000 GALLONS	340	238

Notes:

- a. Costs are based on one year remediation of 525,000 gallons of heavy metal contaminated groundwater.
- b. Assumes 474 bags of Sponges used with no regeneration.
- c. Assumes 158 bags of Sponges used and regenerated twice.

percentage breakdown of each operating scenario is presented in Figure 3-1. Conclusions drawn from the economic analysis are discussed below.

For this groundwater scenario, it is more cost effective to regenerate the Sponge twice rather than replacing it when it is saturated. The groundwater treatment cost with replacement was estimated at \$340/1,000 gallons compared to \$238/1,000 gallons for regeneration. Obviously, the more times the Sponge can be regenerated, the greater the cost savings. Analyzing the pertinent cost factors for both scenarios (i.e., consumable/supplies, labor, residuals and waste shipping and handling) it is estimated that for each regeneration cycle approximately \$170 in cost savings is realized. However, it is important to note that regeneration may not be feasible or practical (e.g., radioactive waste) for all contaminated liquid waste streams, including groundwater.

For both replacement and regeneration, Consumables & Supplies accounted for most of the total costs. However, on a percentage basis there was a two-to-one difference between the two cases considered. For replacement, Consumables & Supplies accounted for approximately 61% of total costs, whereas for regeneration, it accounted for only 34% of total costs. The next largest categories, not necessarily in order, were Site Preparation, Labor, and Residuals and Waste Shipping and Handling. The relative order and percentage of each cost category differed for each case considered. For example, Labor, at 26%, is the second largest cost category for regeneration due to the decreased cost for Consumables and Supplies and the additional time spent regenerating the Sponge and disposing of the resulting liquid waste. For replacement, Labor was the fourth largest category at 10%. Although the order is a little different, Consumables and Supplies; Site Preparation; Residuals and Waste Shipping and Handling; and Labor accounted for over 95% of costs in either case. This indicates that Capital Equipment, Startup, and Utility costs are relatively unimportant in terms of overall treatment cost,

The effective absorption capacity of the Sponge for the metals of concern has the most significant impact on costs as it determines the frequency of replacement or regeneration. To illustrate this point a cost estimate was developed for utilizing the technology solely for the remediation of copper. Based on demonstration results the Sponge had a much greater capacity for copper than for cadmium. Although the SITE demonstration was not conducted long enough for the column to be saturated with copper, a non-linear extrapolation of the data determined the estimated absorption capacity for copper. Based on the estimated absorption capacity, the influent mass loading of copper, and assumed removal efficiency

Figure 3-1

Replacement Cost Breakdown

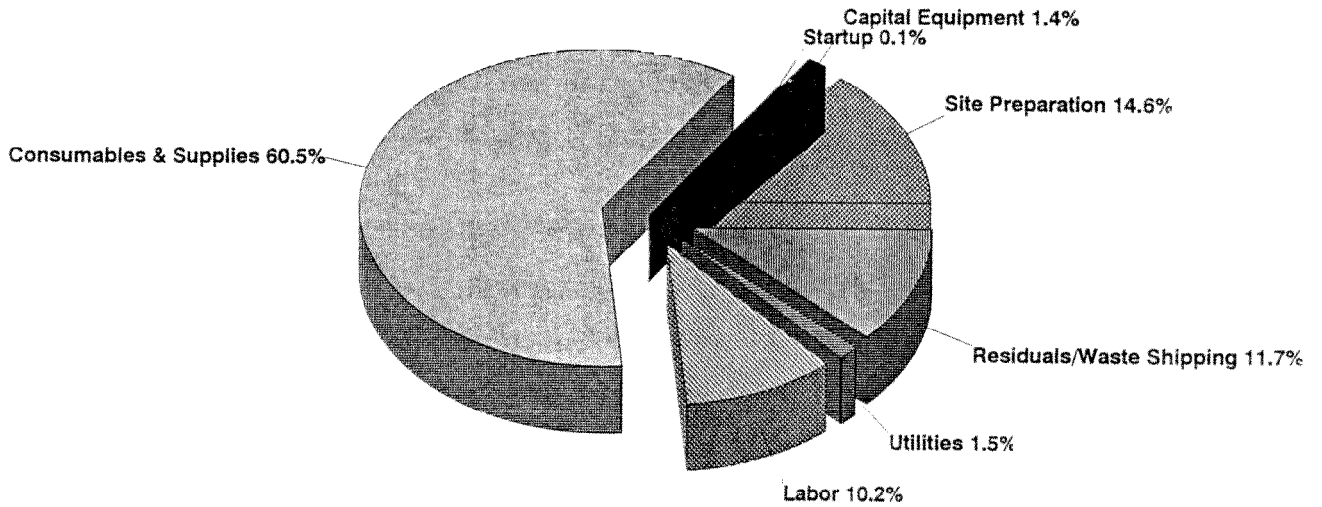

Regeneration Cost Breakdown

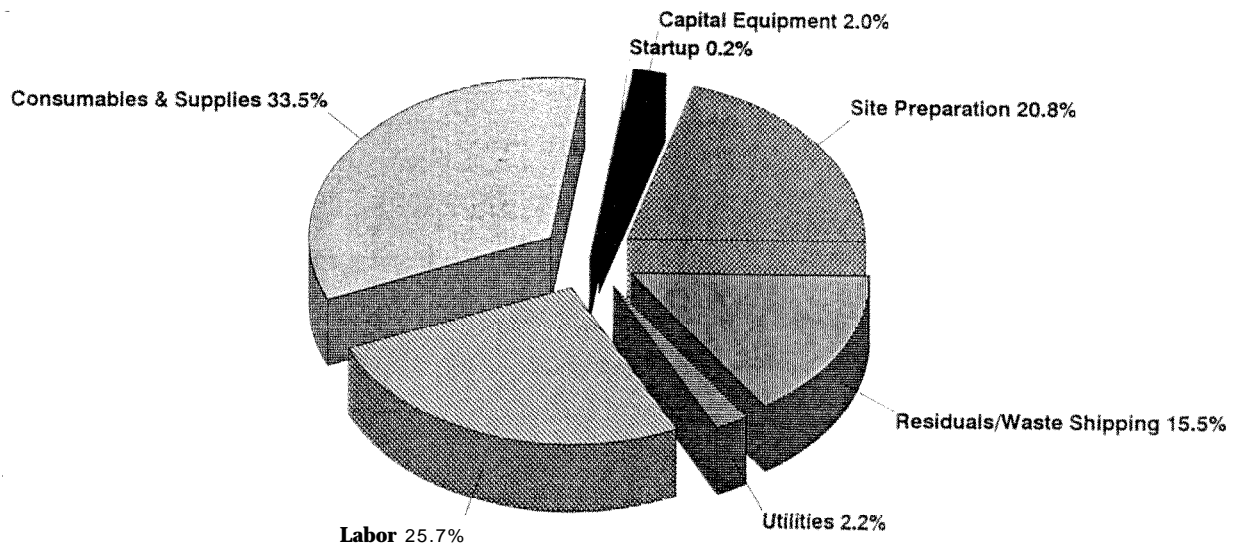

for copper, it was determined that regeneration and/or replacement of the Sponge due to copper saturation would be required every 100 hours, as opposed to every 18 hours due to cadmium saturation. The resultant estimated cost for treating the groundwater for copper is \$1240,000 gallons for replacement and \$104/1,000 gallons for regeneration. This translates to an approximate 56% to 64% reduction in cost on a \$0,000 gallon basis for both scenarios.

Increasing treatment volume (without sacrificing treatment performance) by utilizing larger scale units that can handle more throughput, or similar sized units connected in parallel, can reduce unit costs for treatment. The Developer provided costs for a trailer unit incorporating larger diameter columns which could operate at twice the flow rate of the demonstration unit. Although there would be a cost increase in the Consumables & Supplies and Residuals/Waste categories, scale-up would reduce the unit cost for treatment because larger bags of Sponges are utilized. Assuming similar treatment performance, the larger scale unit would reduce the treatment cost, in terms of \$/1 000 gallons, by approximately 18% to 27% for the replacement or regeneration scenarios. This demonstrates that a combination of design and operating parameters could be adjusted to treat water at a particular site in the most cost-effective manner possible. Additionally, use of an industrial waste compactor to compact Sponges could also aid in lowering disposal costs.

3.2 Basis for Economic Analysis

Dynaphore, Inc. claims that the Forage™ Sponge Technology can treat a wide variety of heavy metal contaminated aqueous waste such as groundwater, landfill leachate, and industrial effluent. Contaminated groundwater was selected as the basis of the economic analysis because it was the aqueous waste treated for the demonstration. Additionally, it represents a waste commonly found at Super-fund and RCRA corrective action sites, and covers several cost categories.

A number of factors affect the estimated costs of treating groundwater with the Forage™ Sponge technology. These factors include type and concentration of contaminants, flow rate, number, type, and depth of groundwater extraction wells required, physical site conditions, geographical site location, required support facilities, site accessibility, availability of utilities, and treatment goals. Type and concentration of contaminants potentially have the greatest impact, as they will determine the effective

absorption capacity of the Sponge which ultimately affects consumable and supply costs (i.e., Sponges and acid for regeneration) and disposal costs.

Cost data associated with the Forage™ Sponge Technology has been assigned to the following 12 categories: (1) site preparation; (2) permitting and regulatory requirements; (3) capital equipment; (4) startup; (5) consumables and supplies; (6) labor; (7) utilities; (8) effluent treatment and disposal; (9) residuals and waste shipping and handling; (10) analytical services; (11) maintenance and modifications; and (12) demobilization.

3.3 Issues and Assumptions

This section summarizes the major issues and assumptions used to evaluate the cost of the Forage™ Sponge Technology. In general, assumptions are based on information provided by the Developer and observations made during the demonstration project. Certain assumptions were made to account for variable site and waste parameters and would, undoubtedly, have to be modified to reflect specific conditions at other sites.

This economic analysis assumes that the Dynaphore, Inc. system will treat groundwater contaminated with cadmium, copper, and lead to demonstration performance claims. The groundwater is assumed to have similar waste characteristics to the groundwater treated for the demonstration, in terms of types and concentrations of heavy metals, TDS, TSS, sulfate, and pH. The groundwater would be treated with a pump-and-treat system similar to that utilized for the SITE demonstration. Specifically, the groundwater is pumped through a series of four upflow columns at a flow rate of 1gpm. The system would be operated 24 hours per day, 7 days per week for 1 year, resulting in a total volume of approximately 525,000 gallons. The only modification to the trailer-mounted system used for the SITE demonstration is that the trailer would include two additional standby columns. This will allow for continuous operation of the system, with no shutdown required for regeneration and/or replacement.

Although the bags of Sponges were not replaced during the SITE demonstration, it was clear that some of them had become saturated and had begun to show performance deterioration by the end of the 72 hour period. The frequency of replacement and/or regeneration is site- and waste-specific. Different metals will saturate a Sponge at different rates. In addition, the higher the concentration of a specific

metal, the faster a Sponge will be saturated. For purposes of this analysis, the SITE demonstration test results were used to predict the saturation rate of the Sponge to identify the frequency of replacement or regeneration. Costs for both cases were investigated; however, regeneration of the Sponges contained within the four column unit was not evaluated for the demonstration. Therefore, the ability to regenerate the Sponges was based on the Developer's laboratory tests and the assumption that the Sponge for the demonstration groundwater could be regenerated twice providing for three useful cycles.

The following is a list of further assumptions used for this analysis:

- The site is a Superfund site located in the Northeast.
- Suitable site access roads exist.
- No pretreatment of the groundwater is required.
- Treated effluent will be suitable for indirect discharge to a POTW.
- Utilities such as water and electricity are available on site.
- Storage facilities for chemicals and residual waste are available on site.
- Construction of a suitable building enclosure will be required to house the equipment.
- One lead operator would be required to monitor the system and perform routine maintenance. A junior operator would be required to assist him/her when replacement or regeneration of the Sponge is required.

3.4 Results of the Economic Analysis

Costs associated with the hypothetical remediation of groundwater are presented below for each of the 12 cost categories.

3.4.1 Site Preparation

It was assumed that preliminary site preparation would be performed by the responsible party (or site owner), and should be minimal as compared to other remediation approaches. Site preparation responsibilities include site design and layout; surveys and site logistics; legal searches; access rights and roads; and preparations for support facilities, decontamination facilities, utility connections, and auxiliary buildings. None of these costs has been included here.

Instead, for purposes of this cost estimate, installation costs have been limited to technology-specific site preparation requirements. These costs are generally one-time charges. Drilling and preparation (purging, casings, caps, etc.) of groundwater wells were assumed to be performed by a contractor. Although these costs are highly site specific, they were included here at a rate of \$2,000/well. Since only one well is assumed to be necessary, this cost would total \$2,000. Additional well costs would include purchase of a 2 inch submersible groundwater pump and associated discharge piping. The estimated cost for these items is \$3,000.

An enclosure to house the trailer unit and protect equipment and personnel from weather extremes is recommended. The cost of constructing a 10 ft x 15 ft x 15 ft high structure with a six-inch high bermed concrete pad was estimated at \$10,000.

Based on experience from the SITE demonstration, a 6,500 gallon influent equalization tank would be needed. The total cost for this system, including a recirculation pump and ancillary piping, is estimated at \$11,000.

Water may be necessary occasionally for regeneration of Sponges, cleanup, and decontamination. It was assumed that a readily accessible supply of water is nearby. Hence, no cost or provision for a water supply was included.

The total site preparation cost is estimated at \$26,000 or \$50/1,000 gal for a year remediation.

3.4.2 Permitting and Regulatory Requirements

Permitting and regulatory costs are generally the obligation of the responsible party (or site owner). These costs may include actual permit costs, system health/safety monitoring, and analytical protocols. Permitting and regulatory costs can vary greatly because they are very site- and waste-specific. No permits were required for this SITE demonstration; therefore, no permitting costs have been included in this analysis. Depending on the treatment site, however, this may be a significant factor since permitting can be a very expensive and time-consuming activity. Nevertheless, any such cost should be very similar for both the replacement and the regeneration scenario.

3.4.3 Capital Equipment

Capital equipment costs were provided by Dynaphore, Inc. They included a six column (four columns for treatment and two stand-by columns) trailer-mounted system with associated plumbing (pipes, valves, and fittings) and pumps, process control and monitoring equipment, and water heater. The columns do not include the Sponges in the fishnet bags. The cost for the 1 gpm system tested here is approximately \$25,000. If this is amortized over 10 years, then the annualized equipment costs are \$2,500 or \$5/1,000 gallons.

The Developer also quoted a price for a slightly larger system than that utilized here. This larger system would utilize 12 inch diameter columns instead of 8 inch diameter columns, and would cost about \$30,000. It would be just as effective, but at a flow rate of 2.3 gpm instead of 1 gpm it could treat 1.21 million gallons of water per year. Each column would contain two slightly larger fishnets of Sponge stacked one on top of the other. Each fishnet bag of Sponge would cost about \$240 or \$480/column.

3.4.4 Startup

Transportation costs for the mobile unit are only charged to the client for one direction of travel and are usually included with mobilization rather than demobilization. They are variable and dependent on site location. Transportation costs are not expected to be a major factor. For purchased units, transportation costs are borne by the buyer.

The amount of on-site assembly required for the mobile unit (or a permanent installation) is minimal, consisting of unloading equipment, connecting plumbing, and assuring that all joints are leak-free. Mobilization and training were estimated to take one person about 2 days. This relatively short setup time was included in the total time on site (1 yr).

It was anticipated that installation of wells would be done before mobilization of the Forager™ system, based on careful review of existing site characterization data. Well installation would be carried out by a drilling contractor, but it would presumably require oversight by one person. Assuming one well could be drilled and cased per day, this would add only an additional day to the schedule. The cost of this has already been accounted for under Site Preparation Costs.

Depending on the site and the contaminants, local authorities may impose specific guidelines for health and safety monitoring programs. The stringency and frequency of monitoring required may have a significant impact on project costs.

Fixed costs such as insurance and taxes were also included here. The total of all startup costs was assumed to be 10% of the annual capital equipment costs, or \$250.

3.4.5 Consumables and Supplies

The major consumable items used by the Dynaphore process are Sponges. Two scenarios were considered in estimating the cost. The first scenario was the replacement of a bag of saturated Sponge with a bag of virgin Sponge, while the other case involved the regeneration of the Sponge and subsequent reuse.

For each of the two cases mentioned above, the frequency of replacement or regeneration was based on the saturation rate of cadmium. SITE demonstration results revealed that for this groundwater cadmium saturated a Sponge at a higher rate than lead or copper.

The average influent concentration of cadmium was measured to be 537 ug/L, corresponding to a mass flow rate of 0.122 gm Cd/hr ($1 \text{ gpm} \times 537 \text{ ug/L} \times 3.785 \text{ L/gal} \times 1 \times 10^{-6} \text{ g/ug} \times 60 \text{ min/hr}$). The SITE demonstration test results showed that a bag of virgin Sponge becomes saturated and is no longer effective in removing cadmium after approximately 49 hrs (see Table 4.3, Section 4). Based on the demonstration data, after 49 hours the Sponge in the first column had absorbed 2.14 grams of cadmium and had achieved an average removal efficiency for cadmium of 95%. Therefore, treating an average mass flow rate of 0.122 gm Cd/hour over a one year period (8760 hours) at a removal efficiency of 95% removal, the total mass absorbed by the four column system is 1015 grams. Dividing the total mass absorbed (1015 grams) by the absorption capacity of each Sponge column (2.14 grams) provides the total number of bags of Sponges needed over a one year period. This calculates to 474 bags of Sponges needed with a bag requiring replacement or regeneration approximately every 18 hours based on 8760 hours per year. The following provides cost for replacement and regeneration.

Replacement

The Developer has quoted the cost of each new fishnet bag of Sponge at \$215. Therefore, the cost of utilizing 474 bags of Sponges is \$101,910. The additional cost of disposing of the spent Sponge is discussed under Residuals and Waste Handling and Shipping.

Regeneration

Replacement costs may be reduced by regenerating each Sponge rather than replacing it. The Developer has indicated that a spent Sponge can be regenerated by very slowly running 34 quarts of 10% industrial grade HCl at one quart/minute. This estimate assumes the HCl is not heated to 40°C and the HCl is retained in the columns for approximately 2 hours (see Section 2.2). Following the acid regeneration, the Sponge would be washed with an additional 34 quarts of fresh water before being placed back on stream. The disposal of the resulting 68 quarts of effluent liquid with 5% HCl concentration containing dissolved heavy metals is discussed under Residuals and Waste Shipping and Handling.

The Developer claims that regeneration will remove about 80% of the absorbed Cu, 70 % of the Pb, and 95% of the Cd (based on their laboratory experiments with Sponge retrieved from the demonstration treatment unit). The Developer did not perform any test on the number of times the Sponge can be effectively regenerated; however, the Developer has assumed that each Sponge can be regenerated two times after which it must be disposed of. Although the effectiveness of the regenerated Sponge in subsequent absorption cycles is unknown, it was assumed here, for simplicity, that it would still be capable of absorbing enough of the dissolved heavy metals to meet the minimum project objectives.

For the regeneration scenario, the 474 bags of virgin Sponges required for replacement is now reduced to 158 (474/3), since each Sponge bag can be regenerated twice providing for three useful cycles. The cost of the 158 bags of Sponges is \$33,970.

The Developer has given the cost of 34 quarts of 10% industrial grade HCl as \$6.40. The cost to regenerate the 158 bags of Sponges twice will be \$2,022 (316 x \$6.40).

Other Supplies

Four other items included are 55-gallon waste disposal drums, plastic disposal sleeve bags, health and safety gear, and maintenance supplies (spare parts, oils, grease and other lubricants, etc.). Based on the estimated amount of residual generated, (see Section 3.4.9) approximately 150 drums should be sufficient for both scenarios. At \$35/drum the estimated cost is \$5250. The cost for health and safety gear should be approximately \$500. The cost of maintenance supplies was assumed not to exceed 2% of the capital costs on a yearly basis, or about \$50. Spent fishnet bags of Sponges are placed in plastic sleeve bags prior to disposal in a 55-gallon drum. Each sleeve bag provided by the Developer cost \$0.50. Based on the amount of Sponges used, the cost for sleeve bags is \$240 and \$80 for the replacement and regeneration scenarios, respectively.

3.4.6 Labor

Once the system is operating at steady-state, very little additional labor is required. The majority of the work involves the replacement or regeneration of the Sponges. It was estimated that an Operator at \$15/hr would spend approximately 10 hours per week primarily monitoring system operation and performing routine maintenance duties. When replacement or regeneration is required, a Junior Operator at \$7/hr would assist with these activities. Replacement of the Sponges is estimated to take both operators approximately one hour, while regeneration is estimated to take approximately three hours of their time, including containerization of wastes generated (i.e., Sponges and regenerant solution). Replacement/regeneration will be required once every 18 hour period. Hourly rates are straight salaries and do not include benefits, administration/overhead costs, and profit. Travel, per diem, or car rental expenses were not included here but can have a major cost impact if these duties cannot be assumed by an on-site employee.

Replacement

The total labor cost for a 1-year remediation assuming 474 bags of Sponges are used without regeneration is estimated as follows:

Operator:	$\$15/\text{hr} \times [(474 \text{ bags of Sponges} \times 1\text{hr}/\text{bag}) + 520 \text{ hrs of monitoring/maintenance}] =$	\$14,910
Jr. Operator:	$\$ 7/\text{hr} \times 474 \text{ bags of Sponges} \times 1\text{hr}/\text{bag} =$	\$3,318
		\$18,228

Regeneration

The total labor cost for a 1-year period assuming 158 bags of Sponges are used and regenerated twice is estimated as follows:

Operator:	$\$15/\text{hr} \times [(158 \text{ bags of Sponges} \times 1\text{hr}/\text{bag}) + (316 \text{ regenerations} \times 3\text{hrs}/\text{regeneration}) + 520\text{hrs of monitoring and maintenance}] =$	\$24,390
Jr. Operator:	$\$ 7/\text{hr} \times [(158 \text{ bags of Sponges} \times 1\text{hr}/\text{bag}) + (316 \text{ regeneration} \times 3\text{hrs}/\text{regeneration})] =$	\$ 7,742
		\$32,132

3.4.7 Utilities

The electric water heater used to heat the groundwater consumed the largest amount of power by far. Measurements during operation indicated that it used 3.3 kW of power. At \$0.06/kW-hr, the cost of running the heater for a year would be: $3.3 \text{ kW-hr} \times 24 \text{ hr}/\text{day} \times 7 \text{ days}/\text{wk} \times 52 \text{ wk}/\text{yr} \times \$0.06/\text{kW-hr} = \$1,730$

An additional utility cost was included for heating the building enclosure during cold weather months and lighting. This cost is estimated at \$1,000

Water was assumed to be readily available and relatively inexpensive. Since the amount of water necessary for decontamination and flushing during the demonstration was small, no costs for water usage were included.

3.4.8 Effluent Treatment and Disposal

As stated earlier, this process is designed to treat the heavy metal constituents of wastes. As such, it would most likely be used in conjunction with other methods that can treat other waste constituents before discharge. Hence, the effluent from the Dynaphore Inc., process may serve as the influent for another downstream treatment technology. In that case, the inclusion of an effluent treatment and disposal cost would not be appropriate. Conversely, the Dynaphore Inc., process may be the last step in a total treatment train.

Based on experience from this SITE demonstration, the resulting effluent was sent to a POTW for disposal. Hence, for purposes of this economic analysis, it was assumed that the effluent from the Dynaphore Inc., treatment technology would meet the regulatory standards appropriate for discharge to a POTW and therefore, no costs associated with effluent treatment and disposal were assigned.

3.4.9 Residuals and Waste Shipping and Handling

As discussed under Consumables and Supplies, two basic scenarios were considered - replacement and regeneration. Here, the cost of disposal of residuals generated from each of these cases is considered.

Replacement

474 bags of Sponges per year will be generated as solid waste requiring disposal off-site. Based on experience from this SITE demonstration, four Sponge bags can be hand-compacted into a regular 55-gal drum. At a reported cost of about \$175/drum for disposal as a hazardous waste, including transportation, the total cost of disposal was calculated as:

$$(474 \text{ bags of Sponges} / 14 \text{ bags/drum}) \times \$175/\text{drum} = \$20,825$$

Further compaction of the Sponges could be achieved utilizing a waste compactor, which could reduce the number of drums needed. This was not evaluated in this estimate; however, as stated in Section 2.5, following the demonstration four fishnet bags of virgin Sponges were sent to a waste compacting firm. Their compaction test showed that compaction ratios of approximately 4:1 and 10:1 could be achieved at 20,000 pounds (lbs.) and 85,000 pounds (lbs.) of compaction force, respectively. Based on these compaction ratios, at 20,000 lbs. of force approximately 16 bags of Sponges could be disposed in a 55-gallon drum, and at 85,000 lbs. of force approximately 40 Sponges could be disposed in a 55-gallon drum. According to the vendor, the costs of these compactors range from \$9000 for the 20,000 lb. unit to \$15,000 for the 85,000 lb. unit.

Regeneration

158 Sponges, as well as approximately 5,372 gallons of liquid waste (68 quarts x 316 regeneration cycles) will be generated per year. The cost of disposing of the heavy metal contaminated liquid waste is approximately \$125/drum. The total cost of disposal for this option is:

(158 Sponges / 4 Sponges/drum) x \$175/drum =	\$ 7,000
(5,372 gal / 55 gal/drum) x \$125/drum =	\$ 12,209

	\$ 19,209

3.4.10 Analytical Services

No analytical costs during operation were included in this cost estimate. Standard operating procedures for Dynaphore, Inc. do not require planned sampling and analytical activities. Periodic spot checks may be executed at Dynaphore’s discretion to verify that equipment is performing properly and that cleanup criteria are being met, but costs incurred from these actions are not assessed to the client. The client may elect, or may be required by local authorities, to initiate a sampling and analysis program at their own expense. No costs have been included for pre-disposal testing of wastes.

3.4.11 Maintenance and Modifications

As stated earlier, site preparation activities for the demonstration were carried out by EPA under the SITE Program. Any modification to the site for a more extensive remediation was assumed to be done by the responsible party (or site owner), but such activities might be carried out by a contractor and some of these have already been included under Site Preparation Costs.

3.4.12 Demobilization

It was estimated that demobilization would take about 2 days and would be included in the total time on-site. Site cleanup and restoration was limited to the removal of all equipment, facilities, and wastes from the site. Any additional work will vary depending on the future use of the site, and was assumed to be the obligation of the responsible party or site owner.

SECTION 4

TREATMENT EFFECTIVENESS DURING THE SITE DEMONSTRATION

This section presents the results of the SITE demonstration at the NL Industries, Inc. site in Pedricktown N.J. and discusses the effectiveness of the Dynaphore, Inc. Forager™ Sponge Technology on heavy metal contaminated groundwater.

4.1 Background

The NL Industries, Inc. site is located in Pedricktown, N.J. and encompasses approximately 44 acres. The site was originally a lead smelting facility. Smelting operations at the site terminated in 1981 and the site was placed on the National Priorities List in September 1983. A Remedial Investigation report on the site was approved by EPA in 1991. Groundwater sampling results from the remedial investigation indicated concentrations of lead, cadmium, and chromium in excess of New Jersey groundwater standards.

The Forager™ Sponge Technology was evaluated for its ability to remove heavy metals from groundwater. Percent removals of lead, cadmium, and chromium, the contaminants of concern at the NL site, are the critical parameters for this study. Copper was also considered a critical parameter because of the high removal efficiency observed in predemonstration treatability tests.

The only critical objective for the Demonstration Test was based on the Developer's claim. Based on the results of field and laboratory treatability tests on the groundwater, the Developer claimed that the technology would achieve at least a 90% reduction of lead and copper, an 80% reduction in cadmium, and a 50% reduction of chromium (as trivalent chrome) in the groundwater.

In addition to the critical objective, there were a number of noncritical objectives, which provided additional background data on the technology's operating characteristics, capabilities, and costs. Non-critical project objectives for the demonstration included:

- develop a temporal study of the treated effluent and individual column effluent concentrations for the critical parameters;

- determine selectivity of the Forager™ Sponge for heavy metal ions present in the groundwater by evaluating heavy metal removal efficiencies for both critical and non-critical heavy metals;
- determine the removal efficiencies for radioactive contaminants in terms of alpha and beta radioactivity (low levels of alpha and beta radioactivity were previously detected in the groundwater);
- evaluate the absorption capacity and regenerative capabilities of the Sponge for the critical parameters;
- characterize the quality of the raw influent and final effluent in terms of heavy metals, alpha and beta radioactivity, COD, TSS, TDS, sulfate, pH, and conductivity; and
- gather information to estimate operating costs, (e.g., utility and labor requirements, waste disposal costs, treatment capacity, etc..).

4.2 Detailed Process Description

The technology was evaluated as a pump-and-treat system over a continuous 72-hour operational period using a reservoir of groundwater. A flow schematic of the system is shown in Figure 4-1. Groundwater was pumped from the influent storage tank through a four column system connected in series for upward flow. The flow rate was 1 gpm or 0.08 bed volumes per minute, resulting in a total volume of approximately 4,300 gallons. The columns were situated on a trailer-mounted unit, which included a water heater to raise influent temperature approximately 15° C to increase reaction rates (i.e., improve rate of absorption of metals). The treated effluent was initially discharged to a 250 gallon portable tank from which it was subsequently pumped to a 20,000 gallon final effluent storage tank.

The Sponge in the first three columns was in a calcium presaturated form while the Sponge in the fourth column was in an aluminum presaturated form. The Developer stated that although both forms would be effective for the critical heavy metals, the aluminum form might have a greater affinity for chromium and also would be less affected by the high concentration of sulfate in the groundwater. Further, according to the Developer, replacement or regeneration of the columns was not necessary, since

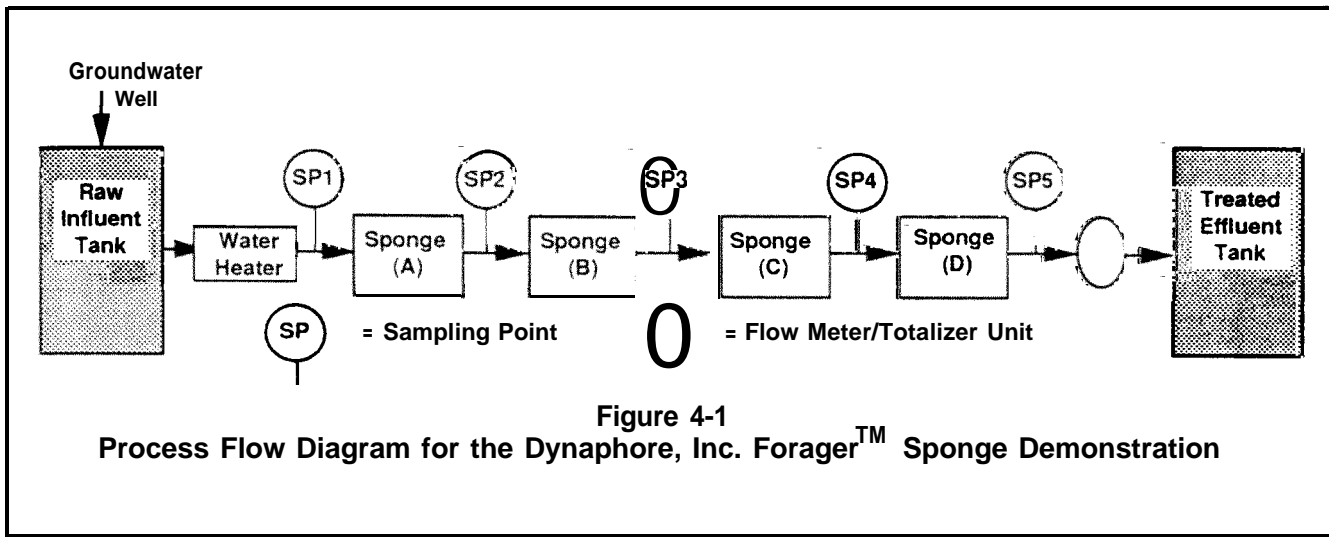

none of the columns were anticipated to become saturated (i.e., no further absorption capacity available for the critical metals). This assumption was based on laboratory absorption tests performed on standard metal salt solutions. Four columns were reportedly needed to provide sufficient path length to meet the demonstration goals.

4.3 Methodology

Although concentrations of some of the critical metals exceeded cleanup goals for the site, the groundwater was spiked with nitrate solutions of lead, copper, and cadmium to assure effective evaluation (quantification) of the Developer’s claim. Due to disproportionately high concentrations of other ions, such as calcium and sodium, samples required dilution prior to analyses to eliminate the matrix interference problem. Diluting the samples resulted in raising detection limits and due to the low initial groundwater concentrations, spiking the groundwater was necessary. Spiked solutions were added to the influent storage tank approximately 24 hours prior to the start of the demonstration. The tank was kept well mixed via recirculation throughout the demonstration.

Grab samples for analysis of critical parameters were collected from the raw influent, final effluent, and intermediate column effluent points (see Figure 1). A total of 162 samples were collected for the critical parameters. Thirty-six samples were taken for each of the intermediate points and the final effluent and eighteen samples for the raw influent. The frequency of grab sample collection was every two hours for the intermediate points and final effluent and every four hours for the raw influent. Sample

frequency for the raw influent was less because the tank was filled prior to the start of the demonstration and was kept mixed during the entire demonstration. Samples for critical parameters were analyzed either by SW846 Method 6010 (Cd, Cr, Cu) or SW846 Method 7421 (Pb).

In addition to critical parameters, three equal volume 24-hour grab-composite samples were collected for total metals, chemical oxygen demand, total suspended solids, total dissolved solids, sulfate, and gross alpha and gross beta radioactivity. COD, TSS, TDS, and sulfate were only collected at the raw influent and final effluent while total metals and alpha and beta radioactivity were collected at all five locations. Pressure, pH, and temperature were also monitored at all sampling locations. Flow rate and total volume were monitored at the final effluent. Since the Developer reported that replacement or regeneration of the columns was not necessary, side tests on laboratory scale columns treating standard metal salt (nitrate) solutions were performed to aid in evaluating the absorption capacity and regenerative capabilities of the sponge.

EPA-approved sampling, analytical, and quality assurance and quality control (QA/QC) procedures were followed to ensure reliable data.

4.4 Performance Data

This section presents the performance data gathered by the testing methodology described above. Results are presented and interpreted below. Data is presented in tabular and/or graphic form. For samples measured at non-detect values, the detection limit was used for the purposes of conservatively calculating the mean concentration.

4.4.1 Summary of Results for Critical Parameters

Table 4-1 presents raw influent, final effluent, and percent removal data with respect to the Developer's claim for the critical metals. Data is reported at 90% confidence intervals using Student's t-statistics with the exception of the final effluent and percent removal data for copper. Since all the final effluent concentrations for copper were measured at non-detect values, use of t-statistics was not appropriate. Instead, for copper these values are reported nonparametrically as "<" the detection limit (50 ug/L) for the final effluent concentration and ">" the calculated percent removal. Figure 4-2 graphically

TABLE 4-1 PERFORMANCE FOR CRITICAL METALS				
Parameter	90% Confidence Interval for Avg. Influent Conc. (ug/L)	90% Confidence Interval for Avg. Effluent Conc. (ug/L)	90% Confidence Interval for Percent Removal (%)	Claim (%)
Cadmium	537 ± 11	57 ± 13	89 ± 2.4	80
Chromium	426 ± 31	290 ± 30	32 ± 8.4	50
Copper	917 ± 14	<50(*)	>94(*)	90
Lead	578 ± 12	24 ± 2	96 ± .40	90

(*)- t-statistics not applied

Figure 4-2
Final Effluent - Critical Metals

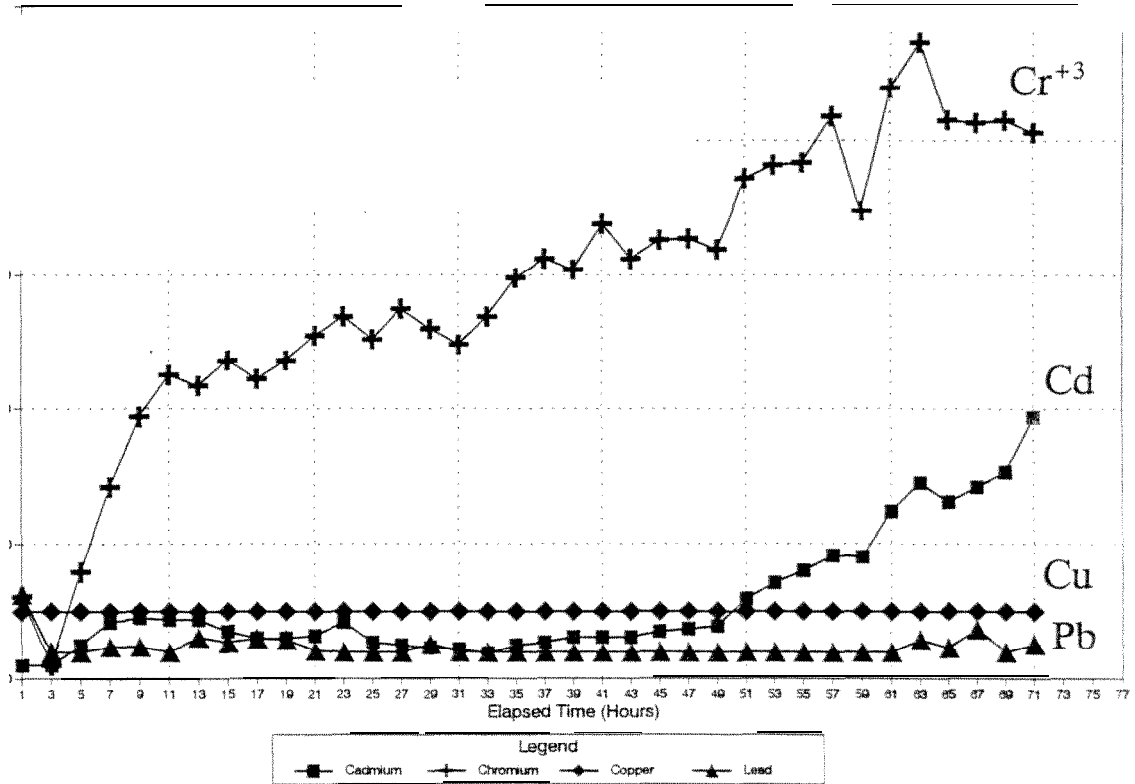

depicts final effluent concentrations versus time for the critical metals. Review of the data shows that claims for cadmium, copper, and lead were achieved. The technology did not achieve the claim for chromium. Claims were based on comparing the mean concentration of the raw influent to the mean concentration of the final effluent over the 72-hour test period. The variability in concentrations between influent and effluent grabs is relatively small as indicated in Table 4-1.

As shown in Figure 4-1, effective removal of chromium (based on the 50% claim) was achieved within the first 10 hours of operation until performance markedly decreased. The decrease in removal efficiency could be the result of the Sponge's higher affinity for the other critical metals. Although the cadmium claim was met based on the overall effluent average, final effluent cadmium concentrations were below desired performance levels (107 ug/L) at approximately the 61st hour of operation. This is due to the lower than anticipated absorption capacity for cadmium which resulted in saturation of the first two columns within the test period.

Tables 4-2 through 4-5 provide effluent data for all four columns for each of the critical parameters. In addition, Figures 4-3 through 4-6 provide graphs of effluent column concentrations versus time for each of the critical parameters. The technology had the greatest affinity for copper. One column was sufficient to meet the Developer's 90% removal claim for approximately 53 hours of the 72 hour test. Copper concentrations for columns 2, 3, and 4, were at or near detection limits throughout the demonstration test. Individual column data reveal the poor affinity for chromium compared to the other critical metals. Based on column 4 effluent data, minimal improvement was observed for the aluminum presaturated Sponge for chromium.

Although claims for cadmium and lead were met, some of the columns became saturated with these metals during the demonstration. Specifically, the first column became saturated with both cadmium and lead, while the second column became saturated with only cadmium. Saturation is defined when the effluent concentration of a given metal is approximately equal to or greater than the influent concentration. Referring to Table 4-2 and 4-5, the first column is saturated with both cadmium and lead at approximately the 49th hour. Approximately 10 hours later, cadmium saturates the second column. None of the columns were saturated with copper during the demonstration test. Based on a non-linear extrapolation of the data, the first column would have become saturated with copper after approximately 4 days of continuous operation.

TABLE 4-2 CADMIUM COLUMN DATA

HOURL	INFLUENT ^(a)	COL.1 EFF ^(a)	COL.2 EFF ^(a)	COL.3 EFF ^(a)	COL.4 EFF ^(a)	TOTAL % REM
1	523	103	<10	<10	<10	98
3		213	102	15	<10	98
5	529	198	128	76	25	95
7		181	133	77	42	92
9	476	166	122	71	45	92
11		199	118	75	44	92
13	537	192	107	56	44	92
15		191	93	59	35	93
17	503	209	96	56	30	94
19		233	86	49	30	94
21	558	250	85	50	32	94
23		284	90	81	42	92
25	568	321	103	51	27	95
27		376	106	110	25	95
29	554	413	118	47	23	96
31		436	127	54	22	96
33	574	440	144	49	19	97
35		501	194	65	25	95
37	545	535	224	69	27	95
39		501	238	69	31	94
41	548	567	273	82	31	94
43		530	275	91	31	94
45	566	524	310	112	35	94
47		530	315	110	37	93
49	566	508	343	124	39	93
51		648	450	170	59	89
53	481	658	467	192	71	87
55		630	568	213	80	85
57	552	663	528	238	91	83
59		558	547	260	90	83
61	514	647	564	291	124	77
63		634	542	306	145	73
65	547	549	627	298	131	76
67		566	569	348	142	74
69	532	549	596	309	153	72
71		540	561	356	194	64
Avg. Conc.	537	423	277	130	57	
Avg. % Rem.		21 ^(b)	35	53	56	89 ^(b)

a = all concentrations in ug/L. Concentrations < 10 ug/L are non-detectable.

b = based on average raw influent concentration = 537

TABLE 4-3 CHROMIUM COLUMN DATA

HOURL	INFLUENT ^(a)	COL.1 EFF ^(a)	COL.2 EFF ^(a)	COL.3 EFF ^(a)	COL.4 EFF ^(a)	TOTAL % REM
1	324	131	17	27	61	86
3		310	222	47	10	98
5	326	335	271	187	79	81
7		293	286	220	142	67
9	327	300	309	244	194	54
11		350	326	309	225	47
13	339	358	332	288	217	49
15		348	323	299	236	45
17	311	309	309	265	222	48
19		324	292	264	236	45
21	378	323	310	292	255	40
23		367	337	791	269	37
25	403	364	357	320	252	41
27		368	338	365	275	35
29	398	355	330	310	260	39
31		381	340	366	248	42
33	442	348	335	342	269	37
35		391	367	347	298	30
37	437	408	399	368	312	27
39		381	395	354	304	29
41	447	409	409	376	338	21
43		424	394	384	312	27
45	469	409	414	398	326	23
47		382	357	350	327	23
49	477	388	386	365	319	25
51		458	425	394	372	13
53	486	444	404	400	382	10
55		457	424	412	384	10
57	498	520	458	444	418	2
59		409	439	452	348	18
61	520	488	452	461	439	-3
63		518	479	474	473	-11
65	537	468	492	443	415	3
67		486	476	271	413	3
69	540	488	505	405	415	3
71		443	416	417	406	5
Avg. Conc.	426	387	365	346	290	
Avg. % Rem.		9^(b)	6	5	16	32^(b)

a = all concentrations in ug/L

b = removal efficiency based on average raw influent concentration = 426 ug/L

TABLE 4-4 COPPER COLUMN DATA

HOUR	INFLUENT ^(a)	COL.1 EFF ^(a)	COL.2 EFF ^(a)	COL.3 EFF ^(a)	COL.4 EFF ^(a)	TOTAL % REM
1	1010	<50	<50	<50	<50	>94
3		<50	<50	<50	<50	>94
5	930	<50	<50	<50	<50	>94
7		<50	<50	<50	<50	>94
9	912	<50	<50	<50	<50	>94
11		<50	<50	<50	<50	>94
13	877	<50	<50	<50	<50	>94
15		<50	<50	<50	<50	>94
17	849	<50	<50	<50	<50	>94
19		53	<50	<50	<50	>94
21	947	<50	<50	<50	<50	>94
23		<50	<50	52	<50	>94
25	922	<50	<50	<50	<50	>94
27		<50	<50	<50	<50	>94
29	904	<50	<50	<50	<50	>94
31		<50	<50	<50	<50	>94
33	903	58	<50	<50	<50	>94
35		<50	<50	<50	<50	>94
37	923	56	<50	<50	<50	>94
39		<50	<50	<50	<50	>94
41	922	<50	<50	<50	<50	>94
43		<50	<50	<50	<50	>94
45	946	57	<50	<50	<50	>94
47		51	<50	<50	<50	>94
49	958	68	<50	<50	<50	>94
51		95	<50	<50	<50	>94
53	890	94	<50	<50	<50	>94
55		117	<50	<50	<50	>94
57	881	139	<50	<50	<50	>94
59		132	<50	<50	<50	>94
61	904	182	<50	96	<50	>94
63		169	<50	<50	<50	>94
65	908	156	<50	<50	<50	>94
67		161	<50	<50	<50	>94
69	913	177	<50	<50	<50	>94
71		176	<50	<50	<50	>94
Avg. Conc.	917	80	<50	<50	<50	
Avg. % Rem.		91 ^(b)	>38	0	0	>94 ^(b)

a = all concentrations in ug/L. Concentrations < 50µg/L are non-detectable.

b = removal efficiency based on raw influent concentration = 917 ug/L

TABLE J-5 LEAD COLUMN DATA

HOURL	INFLUENT ^(a)	COL.1 EFF ^(a)	COL.2 EFF ^(a)	COL.3 EFF ^(a)	COL.4 EFF ^(a)	TOTAL % REM
1	626	68	30	48	63	89
3		109	51	<20	<20	97
5	545	107	65	26	<20	97
7		85	56	33	24	96
9	571	89	56	36	24	96
11		55	34	<20	<20	97
13	584	65	<20	<20	31	95
15		93	51	27	27	95
17	480	86	34	<20	30	95
19		253	33	31	29	95
21	609	129	23	<20	21	96
23		158	34	22	<20	97
25	608	136	28	<20	<20	97
27		236	<20	37	<20	97
29	571	178	30	<20	26	95
31		185	<20	<20	<20	97
33	585	380	44	<20	<20	97
35		252	88	<20	<20	97
37	586	278	47	<20	<20	97
39		312	73	28	<20	97
41	573	321	62	<20	<20	97
43		443	85	<20	<20	97
45	588	406	83	30	<20	97
47		381	89	22	<20	97
49	585	599	118	<20	20	97
51		664	127	20	<20	97
53	572	453	148	39	<20	97
55		488	167	52	<20	97
57	577	447	164	23	<20	97
59		775	195	49	<20	97
61	572	980	351	67	<20	97
63		590	183	62	29	95
65	603	534	231	80	23	96
67		534	375	88	37	94
69	560	536	308	85	<20	97
71		494	312	108	26	96
Avg. Conc.	578	331	107	36	24	
Avg. % Rem.		43^(b)	68	66	33	96^(b)

a = all concentrations in $\mu\text{g/L}$; Concentrations $< 20\mu\text{g/L}$ are non-detectable.

b = removal efficiency based on raw influent concentration = $578\mu\text{g/L}$

Figure 4-3
Cadmium Concentration vs. Time

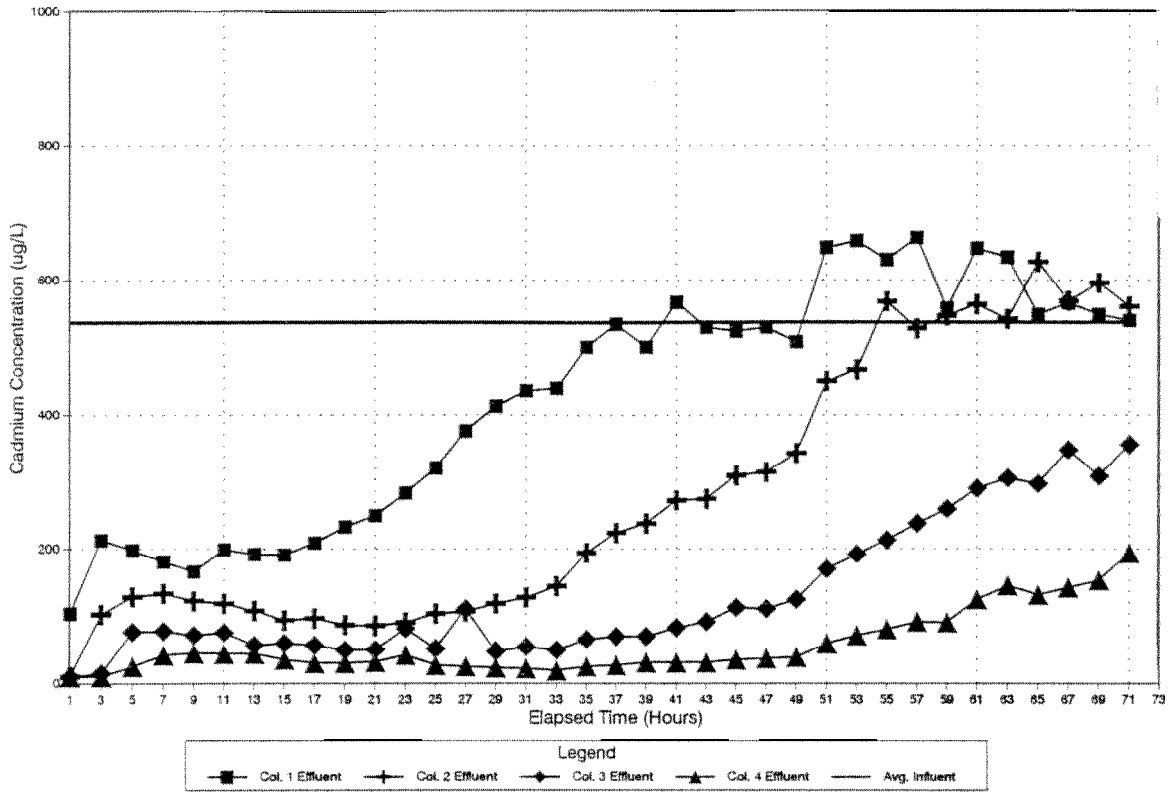

Figure 4-4
Chromium Concentration vs. Time

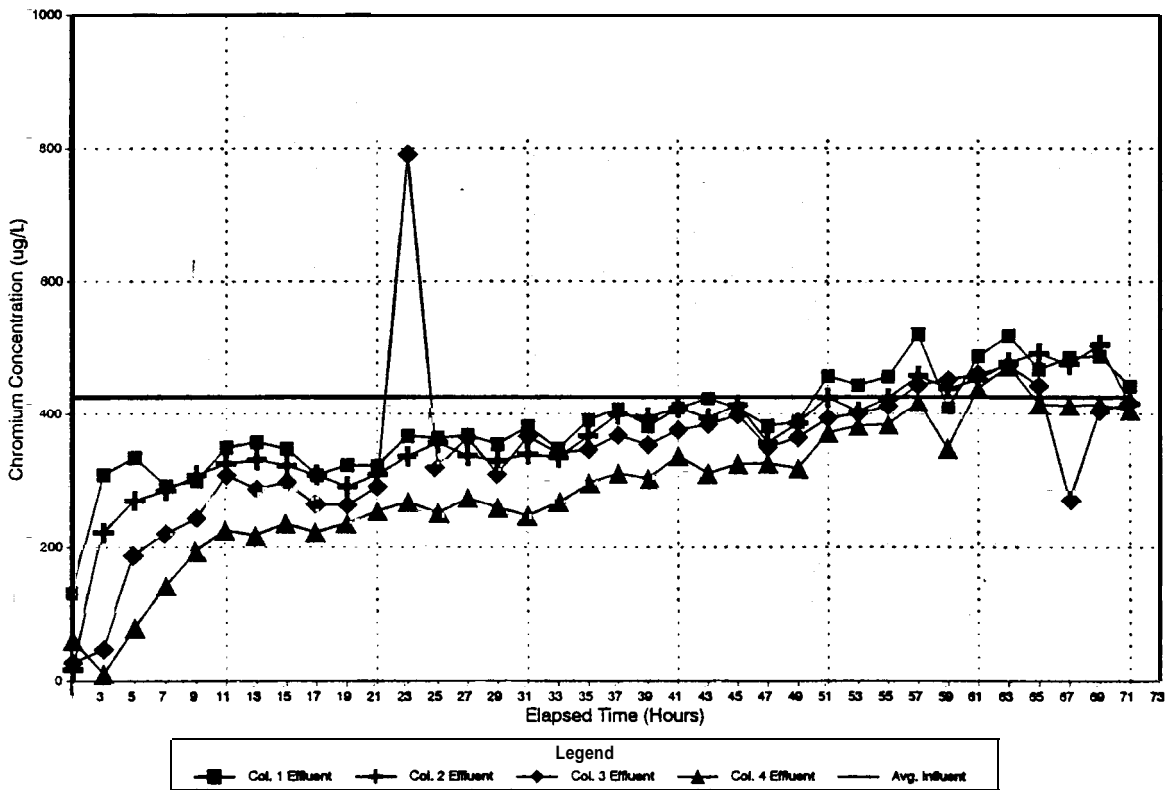

Figure 4-5
Copper Concentration vs. Time

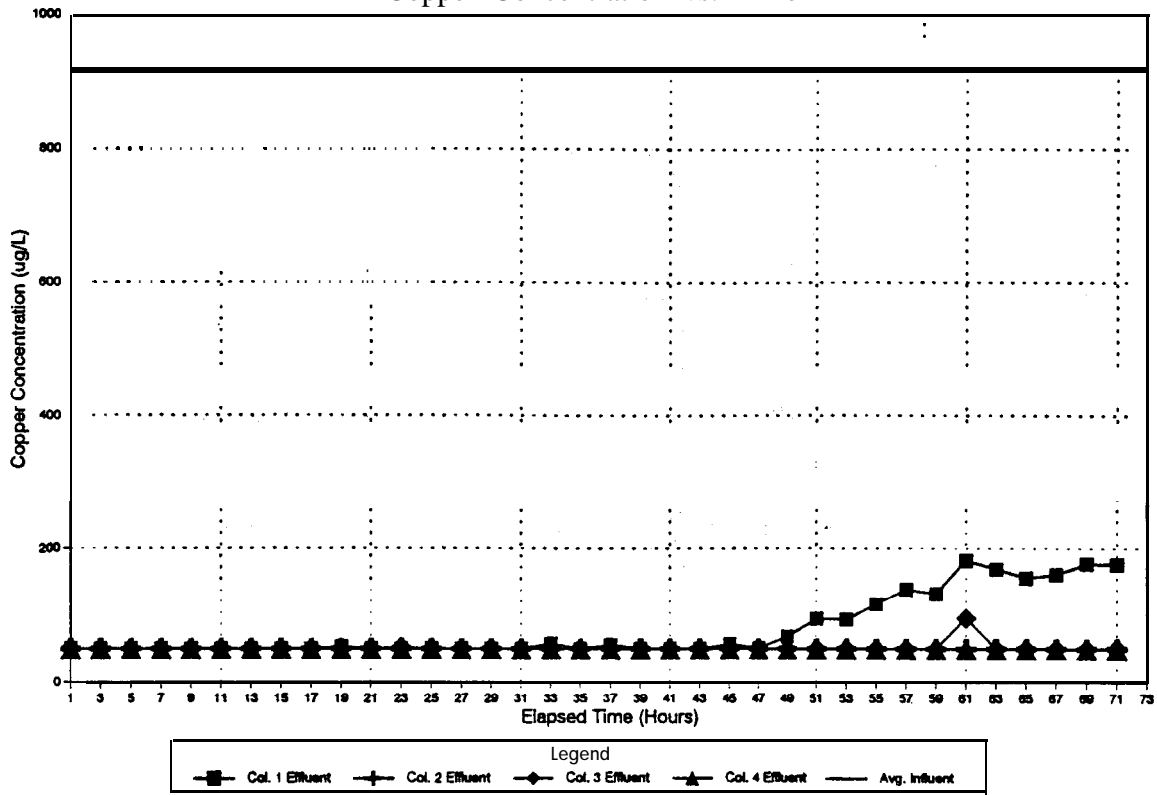
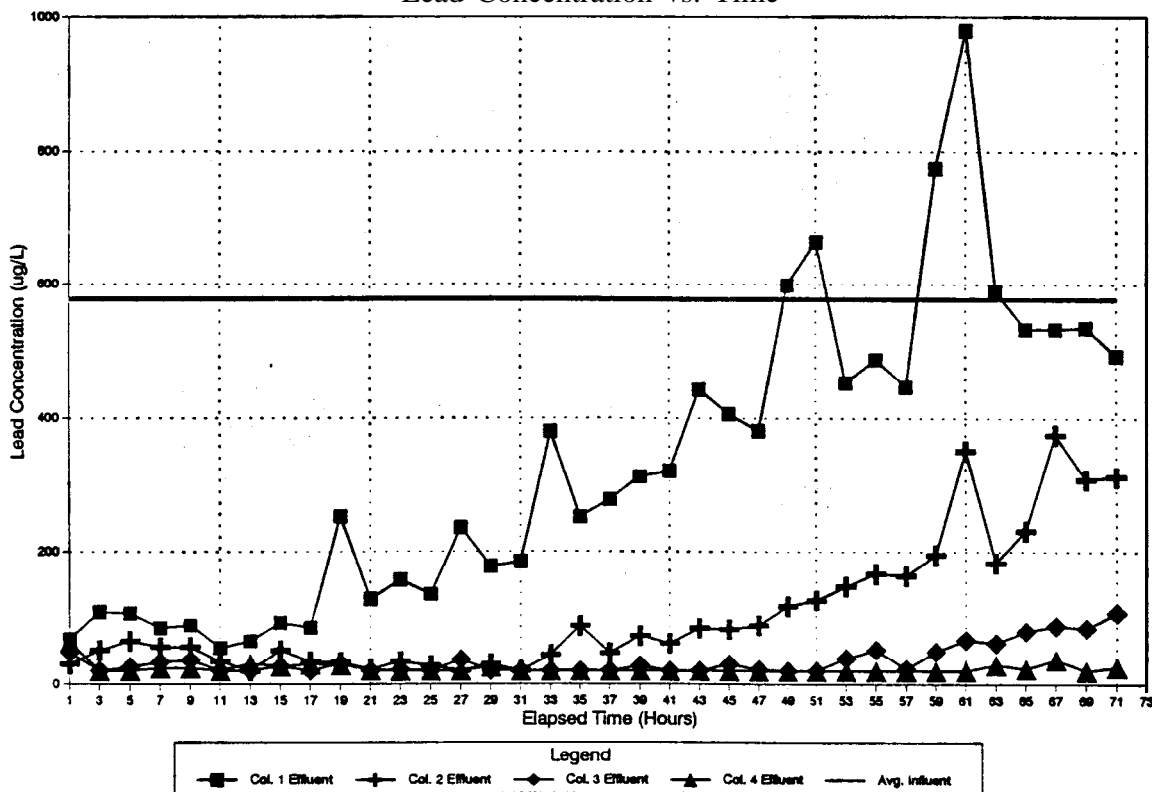

Figure 4-6
Lead Concentration vs. Time



Based on data from the 72-hour demonstration, the actual absorption capacity for the critical metals was significantly lower than anticipated by the Developer's predemonstration absorption capacity estimates and the data from the demonstration absorption capacity side tests. These side tests, which confirmed the Developer's estimates, revealed that the Sponge should theoretically be able to absorb 3% to 5% by weight of each critical metal in a mixed metal solution. Based on the actual demonstration data, not including chromium, the capacity was approximately 0.04% for cadmium, 0.07% for lead, and 0.4% for copper. The Developer theorizes that anion species such as sulfate and phosphate may have reduced the Sponge's absorption capacity for these metals. These anion species are believed to have complexed with the calcium present on the starting Sponge, binding the calcium and thereby not allowing the absorption of target metals.

In addition to the regeneration of the small test columns, the Developer conducted regeneration tests in his laboratory using Sponge cubes taken from the demonstration columns. Both tests showed that regeneration is feasible for lead, copper, and cadmium. Regeneration of chromium was only evaluated for the small test columns and showed only partial regeneration. The number of effective regenerative cycles could not be conclusively determined from these tests.

4.4.2 Summary of Results for Non-Critical Parameters

Total Metals

Table 4-6 presents a summary of analytical results for non-critical heavy metals. As shown, effective removal of cadmium, copper, and lead was achieved in the presence of disproportionately high concentrations of cations such as calcium, magnesium, sodium, potassium, and aluminum. Concentrations for these cations ranged from 70 mg/L for magnesium to 6,000 mg/L for sodium. The technology's low affinity for these cations was supported by the calculated negative removal rates of these ions. Except for calcium and aluminum, the negative removals are probably data anomalies and representative of zero removal rates. Negative removal rates are feasible for calcium and aluminum since the Sponge did contain these ions in the presaturated (starting) form. Reportedly, calcium and aluminum are exchanged (released) from the Sponge for ions with greater affinity.

In addition to 89%+ removal rates for the critical parameters, excluding chromium, the technology also achieved similar removal rates for vanadium. It should be noted that vanadium most likely exists

TABLE 4-6 REMOVAL DATA FOR NON-CRITICAL HEAVY METALS

Parameter	Average Raw Influent Conc. (ug/L)	Average Conc. (ug/L) Column 1	Average Conc. (ug/L) Column 2	Average Conc. (ug/L) Column 3	Average Conc. (ug/L) Column 4	Average Total % Removal
Aluminum	149,000	151,000	155,000	154,000	152,000	-2
Arsenic	47.7	45.5	40.8	47.0	44.4	7
Barium	50.2	44.4	40.8	48.4	46.3	8
Beryllium	15.9	15.4	14.9	14.1	13.9	13
Calcium	224,000	228,000	226,000	242,000	248,000	-11
Cobalt	176	170	171	169	146	17
Iron	199,000	202,000	200,000	205,000	199,000	0
Lithium	460	464	465	487	473	-3
Magnesium	71,700	72,100	72,700	73,600	72,300	-1
Manganese	5870	5930	5940	6000	5880	-1
Mercury	0.39	0.40	0.36	0.29	0.21	46
Nickel	378	352	271	195	107	72
Phosphorus	1520	1510	1310	1070	557	63
Potassium	82,300	84,300	82,600	85,500	83,700	-2
Sodium	6,030,000	6,150,000	6,090,000	6,280,000	6,130,000	-2
Strontium	557	559	555	570	562	-1
Vanadium	1310	828	190	53.2	53.2	96
Zinc	1300	1300	1260	1190	1190	9

as an anionic species in this groundwater. Review of the individual daily composites reveals that the first column did become saturated with vanadium during the third day. Based on the observed absorption capacities and removal efficiencies for the non-critical metals presented in Table 4-6, and the observed absorption capacities and removal efficiencies for the critical metals presented in Table 4- 1, the technology's affinity sequence for metals present in the groundwater is as follows:

Copper>Lead,Vanadium>Cadmium>Nickel>Phosphorus>Mercury>Chromium>Cobalt>Beryllium
Zinc>Barium>Arsenic>Iron, Strontium, Manganese, Aluminum, Potassium, Sodium, Lithium, Magnesium,
and Calcium

The technology's ability to remove radioactive contaminants could not be adequately assessed for this groundwater. Raw influent concentrations of gross alpha and beta radioactivity were significantly lower than anticipated, as the majority of values were at or near detection limits.

Conventional Data

Data for conventional parameters analyzed for the raw influent and final effluent are presented in Table 4-7. As shown the groundwater contained high concentrations of sulfate and TDS averaging around 23,600 mg/L and 20,000 mg/L, respectively. An approximate 5% sulfate reduction was observed which could support the Developer's theory regarding sulfate binding on the Sponge. Although this is a small percent reduction, the sulfate concentration is over 10,000 times greater than the total concentration of critical metals. Therefore, even a minimal reduction of sulfate could significantly decrease the capacity for critical metals removal, if the Developer's theory is correct. Influent TSS concentrations averaged approximately 93 mg/L. It is interesting to note that, except for the second day, TSS concentrations increased across the system, especially during the first day. TSS concentrations for the first 24-hour period increased from 85 mg/L in the influent to 597 mg/L in the final effluent. This could possibly be due to excess cellulose or polymer material washing off the Sponge during the early stages of treatment. This may be supported by the fact that COD increased approximately 150%.

Table 4-7 - Data Summary of Conventional Parameters

Parameter (mg/L)	Day 1		Day 2		Day 3		72-Hour Average	
	Influent	Effluent	Influent	Effluent	Influent	Effluent	Influent	Final
TSS	85	597	107	71	86	102	93	256
TDS	23,500	23,700	23,800	23,400	23,500	22,900	23,600	23,300
Sulfate	23,000	19,000	19,000	20,000	21,000	20,000	21,000	20,000
COD	346	870	424	405	327	211	365	495

The raw influent pH of the groundwater during the 72-hour test ranged from 3.1 to 3.8. Figure 4.7 presents a graph of column effluent pH over time. As shown, the initial pHs of the columns were higher than the raw influent pH until they gradually decreased to the influent pH range. For example, the final pH (column 4 effluent) was initially approximately 7.6 and gradually decreased to the groundwater pH range of 3.1 to 3.8 at approximately the 60th hour of operation. The Developer theorizes that this increased pH effect was possibly due to anion exchange of sulfate in the groundwater, releasing (i.e. exchanging) a hydroxyl group which caused the subsequent rise in pH. As fewer exchange sites for sulfate became available, the pH decreased toward that of the influent.

Process Measurements

Flow rate during the demonstration averaged 0.98 gpm. There was minimal variability in flow as indicated by a % relative standard deviation of only 6%. The raw influent temperature was increased from 17° C to 31° C via the water heater. This temperature was kept fairly constant throughout the demonstration. Based on the pressure measurements taken, input pressures as low as 4.4 psig were sufficient to pump groundwater through the four columns. Due to the range of the pressure gauges utilized (0 to 10 psig) they were not sensitive enough to accurately read pressures on the third and fourth columns. Gauges read zero for these columns during the majority of the demonstration. The average pressure drop across the system was approximately 5 psig. Estimates of the pressure drop resulting from the piping system indicate the pressure drop is minimal; therefore, the drop in pressure can be attributed primarily to the Sponges.

4.5 Process Residuals

Treated effluent was stored in a 20,000 gallon storage tank. This wastewater along with wastewater collected from prior treatability tests was hauled to a local POTW for treatment because there were no sewer lines on site. Approval was received from the POTW for acceptance of the waste prior to the start of the demonstration.

Spent Sponges from the demonstration test and prior treatability tests were hand compacted into 55-gallon drums. A maximum of four fishnet bags of Sponges could be manually placed in a drum. The waste was handled as a hazardous waste for off-site disposal.

Figure 4-7
pH vs Time

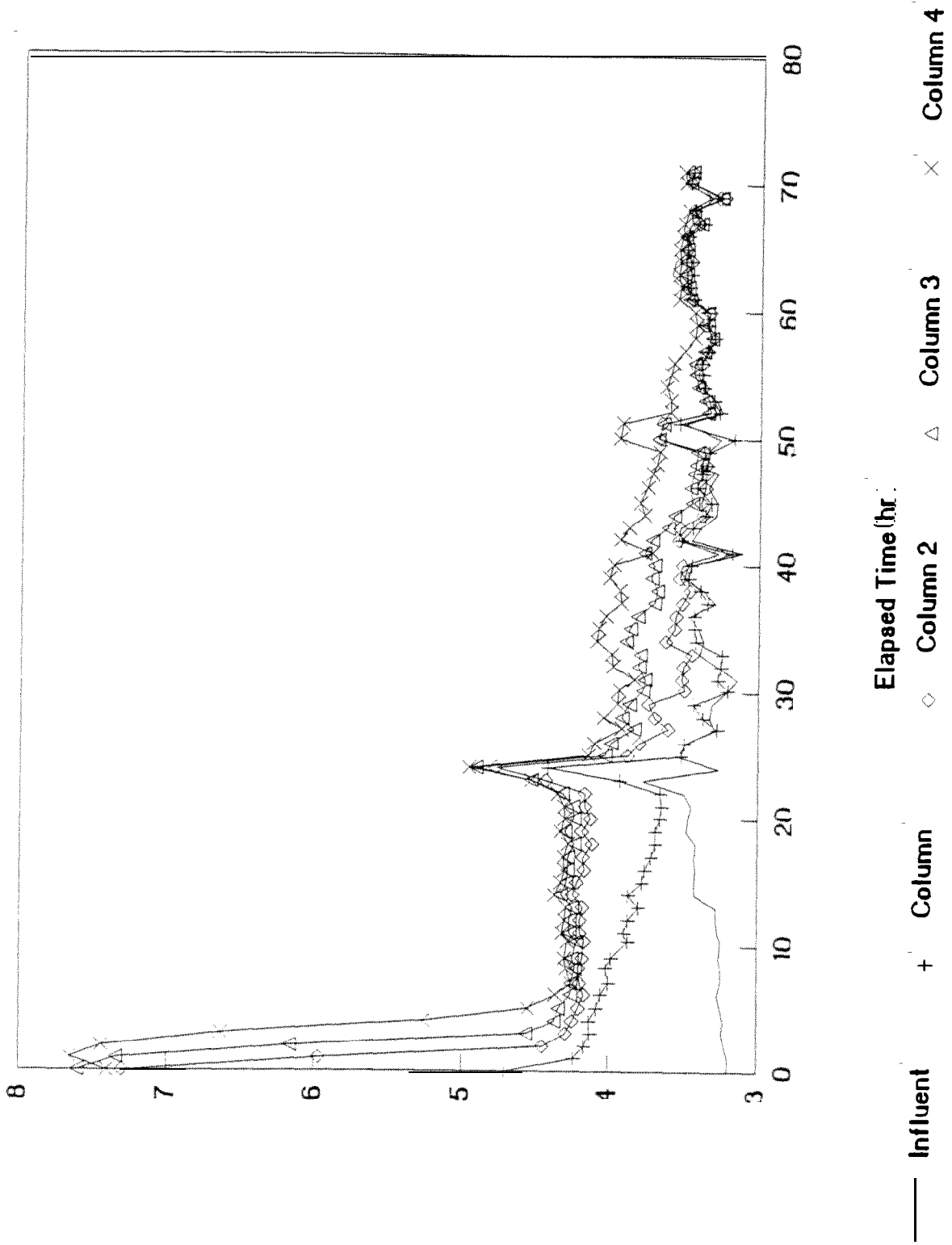

SECTION 5

OTHER TECHNOLOGY REQUIREMENTS

5.1 Environmental Regulation Requirements

Before implementing the Forager™ Sponge Technology, state regulatory agencies may require a number of permits to be obtained. For example, a permit may be required to operate the system as a TSD facility, if the wastewater is considered a RCRA waste. A TSD permit is also required for storage of hazardous wastes generated (i.e., spent Sponges, spent regenerant solution) on-site for greater than 90 days. At the conclusion of treatment, appropriate wastewater discharge permits will need to be obtained for discharge to a publicly owned treatment works (POTW), into surface waters, or through underground injection wells. If off-site disposal of contaminated waste is required, the waste must be taken by a licensed transporter to a permitted landfill.

Section 2 of this report discusses the environmental regulations that apply to this technology. Table 2-1 presents a summary of the Federal and State ARARs for the Forager™ Sponge Technology.

5.2 Personnel Issues

Two technicians are required for initial installation of the system. Once the system is operating at steady state, one technician familiar with the system and the contaminant-specific requirements will be sufficient to monitor the system. This may include checking process parameters (i.e., flow, temperature, pH), collecting any samples for field and/or laboratory analysis, and making any process modifications. When replacement or regeneration of the bags of Sponges is required, based on chemical analysis or performance history, one or two technicians will be needed. Estimated labor requirements for system operation are discussed in Section 3.

For most sites, personal protective equipment (PPE) for workers will include gloves, safety goggles, steel-toed boots, and coveralls. Depending on contaminant types and concentrations, additional PPE may be required.

5.3 Community Acceptance

Potential hazards related to the community are minimal. The Forager™ system generates no chemical or particulate air emissions. The Forager™ Sponge trailer unit is a closed system; therefore even if wastes containing volatile organic contaminants were treated, the potential for on-site exposure to airborne contaminants would be low. Potential chemical hazards exist for workers handling acid solutions used for regeneration. However, when handled appropriately with proper PPE the potential risks are minimized. Proper and secure chemical storage practices for acid solutions and waste regenerant solution and spent Sponges will result in a minimal potential threat of exposure to the community. The quantity of containerized wastes that would be produced is relatively small, thus the movement of transport vehicles through the community would not be significant.

SECTION 6

TECHNOLOGY STATUS

This section discusses the experience of the Developer in performing treatment using the Dynaphore, Inc. Forager™ Sponge Technology. It also examines the capability of the Developer in using this technology at other sites contaminated with heavy metals in aqueous media.

6.1 Previous Experience

To date, this SITE demonstration represents the first full-scale use of this technology. The trailer-mounted unit was built exclusively for this SITE demonstration. Dynaphore Inc., has no experience in the remediation of contaminated sites. To overcome this hurdle, the Developer has formed a liaison with a known environmental remediation firm, Adtechs Corporation of Herndon, Virginia, to provide the necessary expertise in performing full-scale remediations.

Potential in-situ applications of the technology may be promising, but there is insufficient data currently available which demonstrates the viability of this treatment option.

6.2 Scaling Capabilities

The trailer unit can be modified to include additional columns of the same size. A larger scale unit can also be constructed. This unit uses larger columns which would be just as effective as the smaller system but could operate at approximately double the flow rate.

APPENDIX A

VENDOR'S CLAIMS

This appendix was generated and written solely by Dr. Norm Rainer of Dynaphore, Inc. The statements presented herein represent the vendor's point of view and summarize the claims made by the vendor, the Dynaphore, Inc. regarding its Forager™ Sponge Technology. Publication herein does not represent the EPA's approval or endorsement of the statements made in this section.

A.1 INTRODUCTION

The removal of heavy metal species from water has most often been accomplished by techniques involving the addition of a precipitating agent, followed by removal of the resultant precipitate. The high capital investment required for such techniques is often prohibitive except for municipalities or large industrial installations. Ion exchange and reverse osmosis equipment for removal of metal species also involve considerable capital investment, and further require pre-treatment to remove oil and suspended solids. In many instances, a water source containing heavy metals must be remediated where one or more of the following factors are involved:

- a) the site is unattended by operating personnel, or seasonally inaccessible,
- b) electricity is not available,
- c) the water contains considerable oil and/or organics and suspended matter,
- d) the removed species are radioactive, and the simplest absorption and disposal process is needed,
- e) the problem is periodic or short term,
- f) the concentration of heavy metals and/or the volume of water is small, or
- g) budgetary constraints exist.

In such instances, it is desirable to employ an unattended, passive or in-situ remediation system requiring little, if any capital investment, and unaffected by oil or suspended solids. Typical applications may include groundwater, landfill leachate, storm water, acid mine drainage, mine tailings, and other industrial effluents.

The selective removal of certain cationic species from aqueous solutions by way of polymers of specialized composition is well known. Specialty chelating resin products^{1,2} have been marketed for selective absorption of cation species, such resins generally being in the form of 20-200 mesh beads of styrene-divinylbenzene copolymer having iminodiacetic acid functional groups. The properties of such polymers have been extensively studied.^{3,4,5,6} Naturally occurring substances such as algal cells⁷, peat moss⁸ fungal biomass¹³ and municipal sewage sludge⁹ are also capable of selective cation absorption.

In general, highly selective chelation resins function by way of forming coordination bonds which preferably produce 5 member rings involving nitrogen and/or oxygen atoms. A unique order of affinity series for cations is usually characteristic of each particular polymer, based upon its specific functionality. The affinity series is further dependent upon solution parameters such as pH and anion content. Because of the need for sufficient chemical functionality to absorb a single cation by way of formation of a chelate ring, the cation absorption capacity of chelating resins is in the relatively low range of about 0.8 to 3.0 meq/dry gram of resin. By way of comparison, strong acid ion exchange resins based upon polystyrene sulfonic acid can absorb up to about 5.5 meq/dry gram of resin. Furthermore, chelating resins are generally more costly than ion exchange resins.

A.2 THE DYNAPHORE TECHNOLOGY

A low cost chelating resin has been developed by Dynaphore, Inc. of Richmond VA.¹⁰ The resin is a cross-linked aliphatic polyamine/polyamide hydrogel polymer having pendant carboxyl groups. In order to protect the carboxyl groups during polymerization, a polyvalent cation such as Ca^{++} , Mg^{++} or Al^{+++} is added. In various laboratory and field investigations, the general order of affinity of metal cations for the polymer has been found to be as follows:

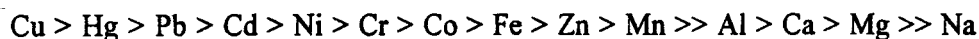

The polymer is capable of forming several different kinds of chelate rings, and is further capable of simple ion exchange reactions and non-chelate complexation reactions. Because of the several different modes of polymer/metal ion interaction, the affinity sequence for a given cation mixture is not always predictable with certainty. Absorbed metals may be displaced by other metals in the course of continued exposure of the polymer to a cation mixture. The final result is dependent upon relative concentrations

and stability constants of the several modes of chemical bonding. Reaction kinetics may be an important factor in determining which metals are absorbed under specific water treatment conditions.

It has further been found that the polymer, once saturated with multivalent cations, functions as a selective anion exchange resin.” Although it is not yet certain which metal/polymer bond structure is involved in anion exchange, the following typical equation is visualized

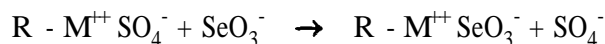

In anion exchange reactions, those reactions are favored wherein the analogous inorganic compound has the smallest solubility product (K_{sp}). Although the anion exchange feature offers interesting applications, (e.g. removal of chromate, arsenate, or cyanide complexes) it can complicate a cation absorption scenario because absorbed cations which associate with a strongly held anion may not exchange with other cations that would otherwise form a stronger cation bonding complex.

The above-described chelating polymer is produced by Dynaphore, Inc. as porous Sponge products¹² marketed as FORAGER™ Sponge, having a cation absorption capacity of about 1.5 meq/dry gram. In the Sponge format, the polymer produces very little impedance to the flow of water. Also, the Sponge can be confined within fishnet bag containers instead of the pressurized vessels conventionally required for bead-form ion exchange resins. Such characteristics make the Sponge well adapted for in-situ applications.

A.3 THE NL SUPERFUND DEMONSTRATION

In the NL Superfund Demonstration, a pump-and-treat approach was used, relying upon an existing well and accumulating tank on site. The Dynaphore apparatus consisted of four Plexiglas columns, each of 8” I.D. and 5’ height, interconnected for upward series flow. Each column held a removable fishnet container filled with pieces of FORAGER™ Sponge of 1/2” cube size. Employing a 12 volt storage battery, the groundwater was pumped from the accumulating tank through the apparatus at a flow rate of 1 gal/min, producing a pressure drop of only 4 psig across the four columns. If alternatively, the four columns had been laid upon the ground in series hook-up, it is quite likely that gravity flow alone from the accumulating tank would have provided the same flow rate. In such disposition, however, regeneration of the Sponge on site would require separate equipment.

The Sponge in the first 3 columns was in a calcium pre-saturated form, achieved by way of calcium-aided polymer production. The Sponge in the fourth column was in an aluminum pre-saturated form. The rationale for employing Ca and Al pre-saturated polymer is that, whereas both metals are easily replaceable by other cations, the Ca form might become deactivated by interaction with the vast amount of SO_4^- in the groundwater. The aluminum form would be expected to survive the effects of high sulfate concentration.

The NL groundwater has a pH of about 3.2, a sulfate concentration of about 20,000 ppm, and high concentrations of cations such as calcium, magnesium, and aluminum. Concentrations of these cations range from 70 ppm for magnesium to 6000 ppm for sodium. The remediation objective was to remove Cu^{++} , Pb^{++} , Cd^{++} and Cr^{+++} which are present at levels of about 1 ppm. An ordinary ion exchange resin, if applied to this situation, would saturate with the abundant ions without absorbing the sought heavy metal ions.

In laboratory tests employing pure nitrate salt solutions, Sponge of the type emplaced in the columns was found to hold at saturation 4% Cu^{++} , 3% Pb^{++} , 3% Cd^{++} and 1% Cr^{+++} (dry weight basis). It was not possible to run saturation trials in the laboratory using actual groundwater shipped from the NL Superfund site because the levels of the treated metals was low and the water is not storage stable. Exposure to air caused precipitation. A sample of about 300 pieces of Sponge was removed from the bottom of the first column at the end of the NL trial. The sample was randomized, dried, powdered, and dissolved in Aqua Regia. Upon analysis of the resultant solution by atomic absorption, it was ascertained that this sample, presumably saturated-with Cu, Pb, Cd and Cr, contained only 0.6% Cu, and less than 0.1% each of Cd, Cr and Pb. In further testing of the same Sponge sample, it was found that elution treatment with 10% HCl removes only 6% of the calcium. By way of comparison, the starting Sponge, when similarly treated, discharges essentially all of its calcium. It therefore appears that the calcium content of the starting sponge, which occupies most of the absorption sites of the polymer, reacted with anion species such as sulfate, phosphate, silicate and vanadate to form intractable compounds. Such effect further explains the lower than expected saturation levels with Cu, Cd, Pb and Cr. The aforementioned anion species, with the exception of sulfate, also interacted with the aluminum pre-absorbed in column 4.

It is to be emphasized that the NL trial represents essentially a single experiment aimed at solving a difficult problem. The FORAGER™ Sponge technology is amenable to chemical variations tailored to specific applications. It is quite likely that a modified polymer structure might have performed better. In fact, the simple expedient of an activation treatment with dilute HCl prior to the NL trial would have produced markedly improved results. Such treatment, by removing all pre-absorbed cations, would have minimized interference by anions.

A.4 OTHER APPLICATIONS

In-situ applications employ a tubular fishnet container filled with the Sponge and placed in shafts or trenches to intercept an existing flow of water. Figure 1 shows a single container bag unit of Sponge vertically emplaced at the neck region of a convergent groundwater collecting zone downstream of the plume. Figure 2 shows a trench installation for groundwater remediation employing a multitude of containers of Sponge horizontally placed in a sand bag type of arrangement. Containers of Sponge can also be utilized tea-bag style or placed within a conduit through which water flows by gravity effect. Loose Sponge is being evaluated in tumble operations in soil washing treatments and in stirred tanks for sludge remediation.

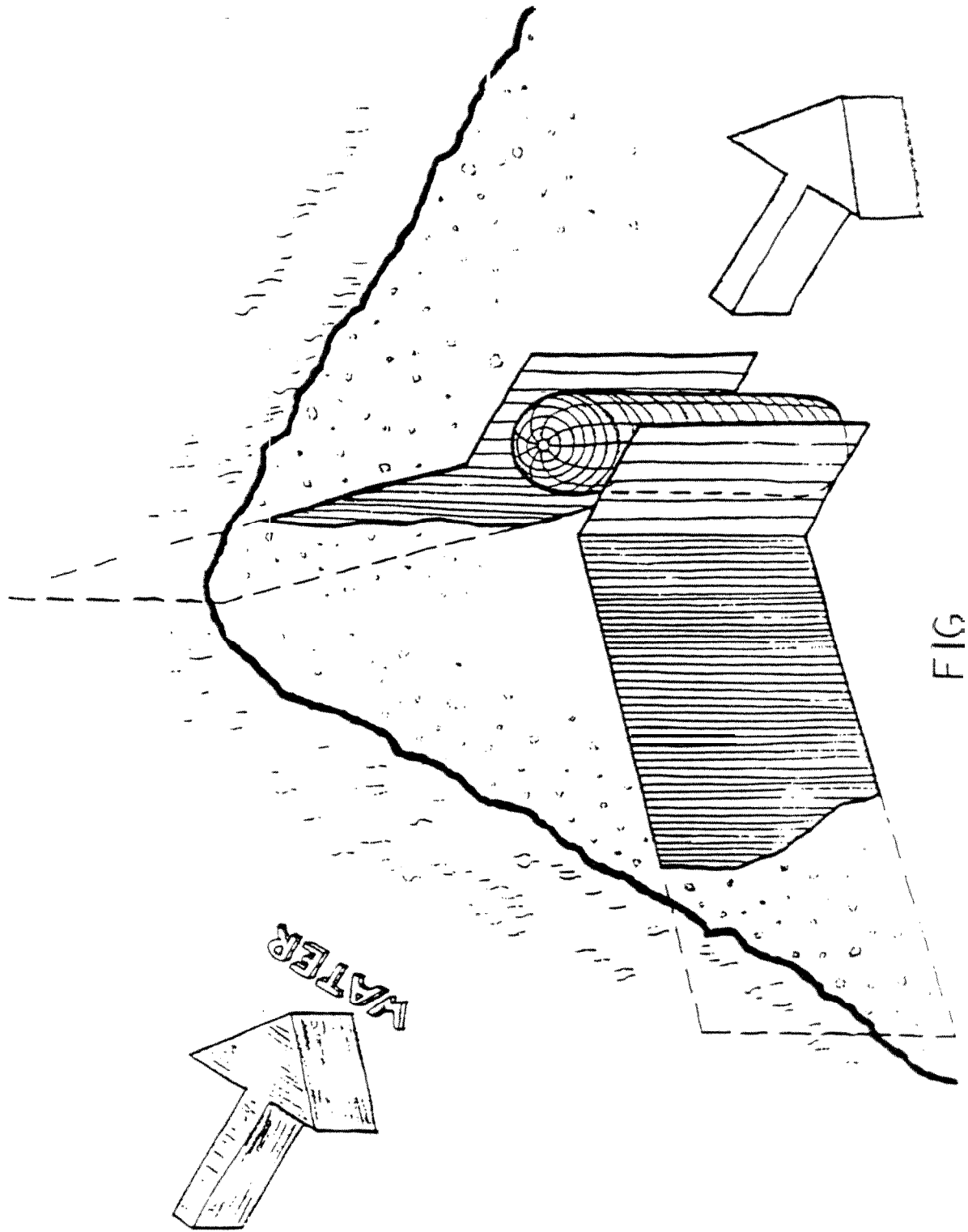

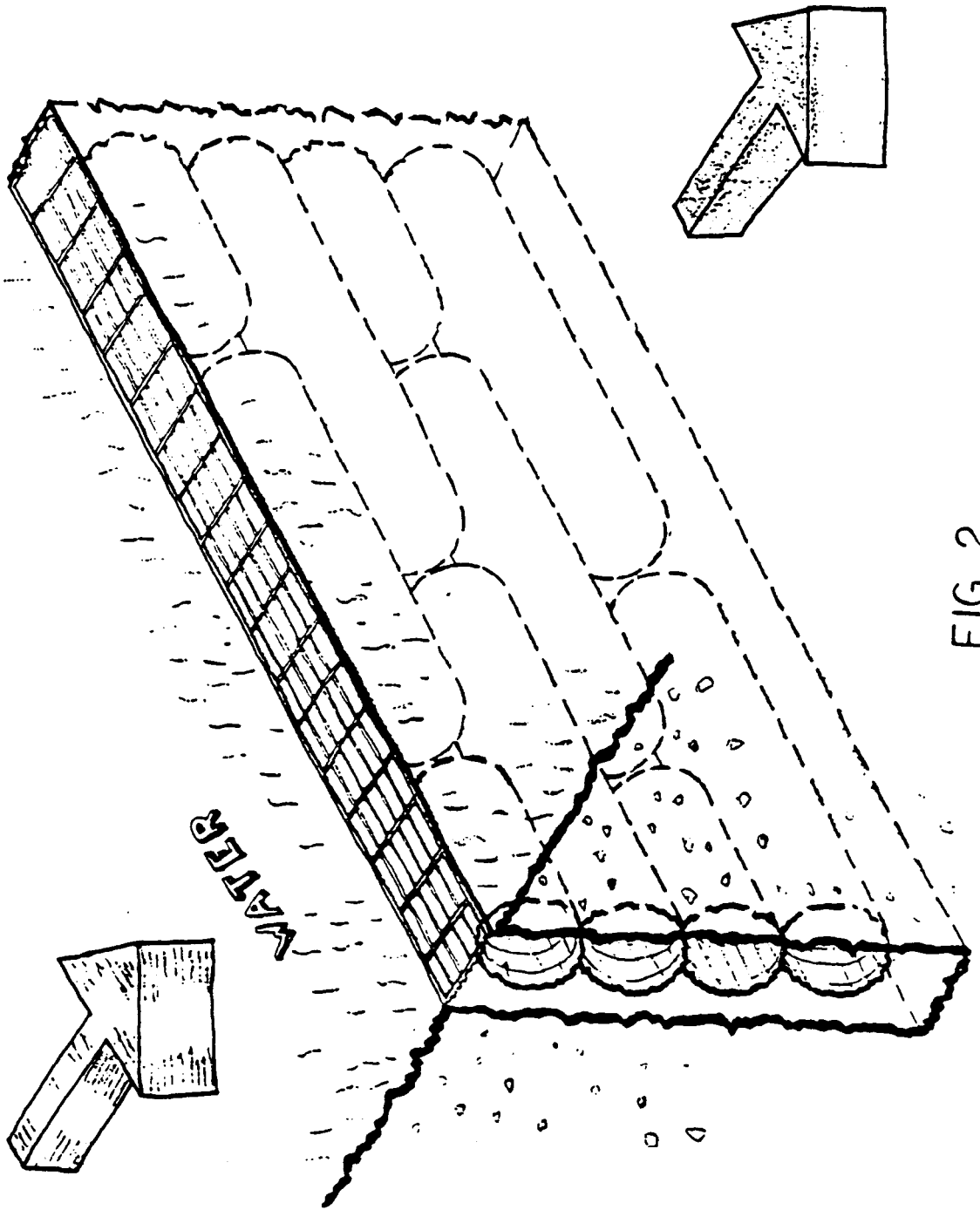

FIG. 2

The saturated Sponge can be eluted and re-used in many applications. Alternatively, or after numerous use cycles, the Sponge may be disposed of by incineration, compaction, or landfill. Because of the non-aromatic chemical composition of the Sponge and the absence of sulfur and halogens, combustion gases resulting from incineration are relatively innocuous. The cost of the Sponge is such as to make one-time use feasible in many instances.

A.5 COSTS

In an idealized situation where the Sponge will absorb cations to laboratory confirmed levels, and if the Sponge is utilized just once to saturation and then disposed of, the cost of absorbing trace heavy metals from water will be in the range of about 20 cents to 40 cents per gram of metal removed. The exact cost under such circumstances is dependent upon the atomic weight of the metal and its efficiency of absorption.

If the Sponge is regenerated employing 5% HCl, followed by a water wash, and if the HCl is recovered by distillation, the operating cost will be essentially the fuel cost for the HCl recovery.

Additional costs will be involved in the transportation, handling and ultimate disposal of the Sponge.

A6. ACKNOWLEDGEMENTS

Dynaphore, Inc. is appreciative of the very efficient and highly professional efforts of SAIC in conducting the NL Superfund Demonstration and evaluating the results. We are also grateful to the EPA, and in particular to Carolyn Esposito for persevering in a difficult challenge for a new technology. We are also thankful to Lou Reynolds of the Adtechs Corp. of Herndon, VA for his early efforts leading to the Superfund Demonstration.

SUMMARY

FORAGER™ Sponge represents a specialized new approach for the selective removal of heavy metals from water. It portends the in-situ remediation of water sources at potentially low cost. The product can be modified to some extent for improved efficiency in particular applications.

References:

1. Chelex 100, Bio Rad Laboratories, Richmond, CA
2. Dowex A-100, Dow Chemical Co., Midland, MI
3. R. Hering, J. Prakt. Chem. 14 285 (1961) (CA 56 6690g, 1962)
4. R. Hering, J. Inorg. Nucl. Chem. 24 1399 (1962) (CA 58, 9655C)
5. R. Hering, Z. Chem. 5 (5), 194 (65) (CA 63, 8556h, 1965)
6. H. Gold and C. Calmos, A. I.Ch.E. Symposium Series No. 192, V.76, p. (60) (1980)
7. Alga SORB, B&Recovery Systems, Inc. Las Cruces, NM
8. T. Jeffers, et al., U. S. Bureau of Mines, Randal Gold Forum p. 112, Apr. 1991
9. H. G. Brown et al, U.S. EPA, Environmental Letters 5(2) p. 103 (1973)
10. U. S. Patent 3,715,339 and other patents and patent applications
11. U. S. Patent 5,187,200
12. U. S. Patent 5,096,946, and other patents and patent applications
13. U. S. Patent 4,732,681