

United States
Environmental Protection
Agency

Hazardous Waste Engineering
Research Laboratory
Cincinnati OH 45268

EPA/540/2-86/001
June 1986

Superfund



Handbook for Stabilization/ Solidification of Hazardous Wastes



EPA/540/2-86/001
June 1986

HANDBOOK FOR STABILIZATION/SOLIDIFICATION OF HAZARDOUS WASTE

by

M. John Cullinane, Jr., Larry W. Jones, and Philip G. Malone
Environmental Laboratory
USAE Waterways Experiment Station
Vicksburg, MS 39180

Project Officer

Janet M. Houthoofd
Land Pollution Control Division
Hazardous Waste Engineering Research Laboratory
Cincinnati, Ohio 45268

HAZARDOUS WASTE ENGINEERING RESEARCH LABORATORY
OFFICE OF RESEARCH AND DEVELOPMENT
U.S. ENVIRONMENTAL PROTECTION AGENCY
CINCINNATI, OHIO 45268

NOTICE

The information in this document has been funded, wholly or in part, by the U. S. Environmental Protection Agency Under Interagency Agreement No. AD-96-F-2-A145 with the U.S. Army Engineer Waterways Experiment Station. It has been subject to the Agency's peer and administrative review and has been approved for publication as an EPA document.

This handbook is intended to present information on the application of a technology for the control of specific problems caused by uncontrolled waste sites. It is not intended to address all waste site problems or all applications of this technology. Mention of trade names or commercial products does not constitute endorsement or recommendation for use.

FOREWORD

Today's rapidly developing and changing technologies and industrial products and practices frequently carry with them the increased generation of solid and hazardous wastes. These materials, if improperly dealt with, can threaten both public health and the environment. Abandoned waste sites and accidental releases of toxic and hazardous substances to the environment also have important environmental and public health implications. The Hazardous Waste Engineering Research Laboratory assists in providing an authoritative and defensible engineering basis for assessing and solving these problems. Its products support the policies, programs and regulations of the Environmental Protection Agency, the permitting and other responsibilities of State and local governments and the needs of both large and small businesses in handling their wastes responsibly and economically.

This report describes reagents and methodology which have been found useful for stabilization/solidification of hazardous wastes and will be useful to industrial and engineering firms which have occasion to deal with waste handling and disposal. It should also be of value for regulatory and environmental groups to assess the technical solutions proposed for specific sites requiring remedial action. For further information, please contact the Land Pollution Control Division of the Hazardous Waste Engineering Laboratory.

Thomas R. Hauser, Director
Hazardous Waste Engineering Research Laboratory

ABSTRACT

This Handbook provides designers and reviewers of remedial action plans for hazardous waste disposal sites with the information and general guidance necessary to judge the feasibility of stabilization/solidification technology for the control of pollutant migration from hazardous wastes disposed of on land. Stabilization/ solidification is an alternative technology that must be identified, analyzed, and evaluated in the feasibility study process.

First reviewed is the chemical basis for this technology and for commercial formulations in common use (Section 2), which is followed by a detailed discussion of waste characterization and site considerations appropriate for treatment process evaluation (Section 3). Methods and techniques for determining the success of stabilization/solidification trials (including specific laboratory testing and leaching protocols) are then described. This ensures that adequate treatment specifications and required characteristics of the final product can be included in process and permitting documentation (Section 4). Bench- and pilot-scale testing are recommended and considered in Section 5.

The actual processing technology used in waste stabilization projects is quite diverse. Four stabilization/solidification scenarios are developed that give a good cross section of the broad spectrum of handling, mixing, and processing equipment currently in use (Section 6). Included are project sequencing and estimated comparative costs for treating 500,000 gallons of waste by the four treatment alternatives. These scenarios illustrate the strengths and weaknesses of each alternative and give guidance as to which processing technology is most suited to specific waste types and site conditions.

Safety, quality control, and environmental considerations also relate to this technology (Section 7). Sampling and testing protocols for assessing containment efficiency and uniformity are given. Final cleanup of the site and equipment, site monitoring, and capping are also discussed as they pertain to treated wastes (Section 8).

This report was submitted in fulfillment of Interagency Agreement AD-96-F-2-A145 by the Environmental Laboratory of the U.S. Army Engineer Waterways Experiment Station under the sponsorship of the U.S. Environmental Protection Agency. This report covers the period of September 1982 to September 1984, and the work was completed as of September 1984.

CONTENTS

	<u>Page</u>
FOREWORD	iii
ABSTRACT	iv
FIGURES	vii
TABLES	x
UNIT CONVERSIONS	xii
ACKNOWLEDGEMENTS	xiii
1. INTRODUCTION	1-1
1.1 Background and Definitions	1-1
1.2 Purpose and Scope of this Handbook	1-2
1.3 Regulatory Basis for Use of Stabilization/Solidification	1-4
2. BASIS OF STABILIZATION/SOLIDIFICATION TECHNOLOGY	2-1
2.1 Types of Treatment Reagents and Processes	2-2
2.2 Compatibility of Wastes and Treatment Processes	2-18
2.3 Pretreatment Techniques for Waste Solidification	2-20
3. PHYSICAL AND CHEMICAL CHARACTERIZATION OF UNTREATED WASTES	3-1
3.1 Physical Characterization	3-1
3.2 Chemical Characterization	3-4
4. SELECTION OF STABILIZATION/SOLIDIFICATION PROCESSES	4-1
4.1 Background	4-1
4.2 Specifications for Stabilized/Solidified Wastes	4-2
4.3 Example Specifications	4-9
5. BENCH- AND PILOT-SCALE TESTING OF SELECTED TREATMENT PROCESSES	5-1
6. FULL-SCALE TREATMENT OPERATIONS	6-1
6.1 Project Planning	6-1
6.2 Cost Analysis and Comparison	6-2
6.3 In-Drum Mixing Alternative	6-3
6.4 In-Situ Mixing Alternative	6-10
6.5 Mobile Plant Mixing Alternative	6-18
6.6 Area Mixing or Layering Alternative	6-31
6.7 Summary	6-36

CONTENTS (continued)

	<u>Page</u>
7. QUALITY CONTROL, SAFETY, AND ENVIRONMENTAL CONSIDERATIONS FOR WASTE TREATMENT	7-1
7.1 Sampling of Treated Wastes	7-1
7.2 Testing of Stabilized and Solidified Wastes	7-2
7.3 Safety and Environment	7-2
8. CLEANUP AND CLOSURE	8-1
8.1 Cleanup of Equipment	8-1
8.2 Site Monitoring	8-1
8.3 Capping of Solidified Wastes	8-2
APPENDIX A - ACQUISITION AND COSTS OF REAGENTS	A-1
A.1 Purchase Price	A-1
A.2 Transportation Costs	A-2
A.3 Onsite Chemical Handling	A-3
A.4 Quantity and Cost of Chemicals Required	A-4
APPENDIX B - TYPICAL STABILIZATION/SOLIDIFICATION EQUIPMENT	B-1
B.1 Chemical Storage Facilities	B-1
B.2 Materials Handling Equipment	B-4
B.3 Materials Mixing Equipment	B-15
B.4 Materials Control Equipment	B-25
INDEX	INDEX-1

FIGURES

<u>Number</u>		<u>Page</u>
1-1	Flowchart for Evaluation of the Stabilization/Solidification Option	1-3
2-1	Mechanisms Retaining Water and Ionic Materials on and in Solid Phases	2-4
2-2	Theoretical Solubilities of Selected Amphoteric Metal Hydroxides	2-21
6-1	In-Drum Mixing Using a Top-Entering Propeller Mixer	6-6
6-2	Typical Spill Cleanup System	6-10
6-3	In-Situ Mixing with a Backhoe at a Large Site	6-12
6-4	In-Situ Mixing by Direct Reagent Injection	6-16
6-5	In-Situ Mixing Equipment	6-16
6-6	Schematic of Plant Mixing Scenario	6-19
6-7	Schematic of a Trailer-Mounted Mobile Mixing Plant	6-21
6-8	Schematic of a Van-Mounted Mobile Mixing Plant	6-21
6-9	Open Mobile Mixing Plant	6-22
6-10	Enclosed Mobile Mixing Plant	6-22
6-11	Drum Handling Mobile Mixing Plant	6-23
6-12	Small Modular Mixing Plant	6-23
6-13	Large Modular Mixing Plant	6-24
6-14	Modular Mixing Plant for Heavy Slurries	6-24
6-15	Portable Plant Mixing Followed by Drum Encapsulation	6-31
6-16	Spreading Untreated Material for Area Mixing	6-33

FIGURES (continued)

<u>Number</u>		<u>Page</u>
6-17	Adding Stabilization/Solidification Reagent for Area Mixing	6-33
6-18	Mixing Waste Materials with Stabilization/Solidification Reagents in Area Mixing	6-34
A-1	Typical Chemical Transportation Costs	A-4
B-1	Installed Cost of Dry Chemical Storage	B-3
B-2	Installed Cost of Liquid Reagent Storage	B-5
B-3	Trailer-Mounted Centrifugal Pump	B-6
B-4	Typical Floating Centrifugal Pump	B-7
B-5	Typical Costs for Pumping Systems	B-8
B-6	Typical Costs for Trailer-Mounted Concrete Pumps	B-9
B-7	Backhoe-Dump-truck Operation for Removal of Contaminated Soils	B-10
B-8	Installed Portable Conveyor System Costs	B-14
B-9	Typical Portable Conveyor System	B-14
B-10	Typical High Speed Rotary Mixer	B-16
B-11	Typical Base Stabilization Plant.	B-16
B-12	Installed Cost for Base Stabilization Plant	B-17
B-13	Installed Cost for Mobile Concrete Batching Facility	B-17
B-14	Installed Cost for Concrete Tilting Mixers	B-18
B-15	Typical Change-Can Mixer	B-20
B-16	Installed Cost for Change-Can Mixers	B-21
B-17	Typical Ribbon Blender	B-22
B-18	Installed Cost for Ribbon Blenders	B-22
B-19	Typical Muller Mixer	B-23
B-20	Installed Cost for Muller Mixers	B-23

FIGURES (concluded)

<u>Number</u>		<u>Page</u>
B-21	Typical Twin Shaft Rotor Mixer	B-24
B-22	Installed Cost for Rotor Mixers	B-24
B-23	Typical Top-Entering Propeller Mixer	B-25
B-24	Weigh Batcher System for Waste Materials Control	B-26
B-25	Typical Screw Feeder	B-27
B-26	Typical Weigh Feeder System	B-28
B-27	Typical Belt Scale System	B-29

TABLES

<u>Number</u>		<u>Page</u>
2-1	Typical Physical and Chemical Properties of Commonly Used Natural Sorbents	2-6
2-2	Natural Sorbents and Their Capacity for Removal of Specific Contaminants from Liquid Phases of Neutral, Basic, and Acidic Wastes	2-7
2-3	Synthetic Sorbents Used with Hazardous Wastes	2-8
2-4	Undesirable Sorbent/Waste Reactions	2-8
2-5	Approximate Reagent Requirements for Solidification of Various Waste Types Using Lime Fly Ash	2-11
2-6	Approximate Portland Cement/Fly Ash Requirements for Solidification of Various Waste Types	2-13
2-7	Compatibility of Selected Waste Categories with Different Stabilization/Solidification Techniques	2-19
3-1	Hazardous Waste Consistency Classification	3-2
4-1	Recommended Testing Procedures for Physical Characteristics that Relate to Waste Settlement	4-7
4-2	Example Specifications for Solidified Waste for Land Burial	4-10
6-1	Cost Estimation for In-Drum Treatment Alternative	6-7
6-2	Cost Estimation for In-Situ Treatment Alternative	6-14
6-3	Cost Estimation for the Mobile Plant Mixing Alternative for Pumpable Wastes (Type 1)	6-26
6-4	Cost Estimation for the Modular Plant Mixing Alternative for Unpumpable or Solid Wastes (Type 2)	6-28
6-5	Cost Estimation for the Area Mixing, or Layering, Alternative	6-35

TABLES (concluded)

<u>Number</u>		<u>Page</u>
6-6	Summary Comparison of Relative Cost of Stabilization/ Solidification Alternatives	6-37
6-7	Comparison of Treatment Costs with Different Reagents.	6-40
7-1	Citations for Current OSHA Regulations Likely to be Applicable at Land-Based Disposal Sites.	7-4
7-2	Policies Applicable to Remedial Actions.	7-5
A-1	Typical Costs of Chemicals Used for Stabilization/ Solidification	A-2
A-2	Specific Weights for Common Materials at Remedial Action Sites	A-6
B-1	Typical Job Efficiency Factors	B-11
B-2	Approximate Rental Rates for Construction Equipment Used for Stabilization/Solidification Projects	B-12

UNIT CONVERSIONS

<u>Multiply US Customary Units</u>	<u>By</u>	<u>To Obtain SI Units</u>
Area:		
Acres	0.4707	Hectares
Square feet	0.0929	Square meters
Square yards	0.8361	Square meters
Flow rate:		
Cubic feet per second	0.0283	Cubic meters per second
Gallons per day	0.0438	Liters per second
Million gallons per day	3,785	Cubic meters per day
Length:		
Feet	0.3048	Meters
Inches	25.4	Millimeters
Power:		
Horsepower	0.7457	Kilowatts
Pressure:		
Pounds per square inch	6.895	Kilopascals
Volume:		
Cubic feet	28.3	Liters
Cubic feet	0.0283	Cubic meters
Gallons	3.785	Liters
Cubic yards	0.7646	Cubic meters

ACKNOWLEDGEMENTS

This Handbook was developed by the Environmental Laboratory of the U. S. Army Engineer Waterways Experiment Station (WES) under the sponsorship of the U. S. Environmental Protection Agency (EPA). Authors were Mr. M. John Cullinane, Jr., Dr. Larry W. Jones, and Dr. Philip G. Malone. The Handbook was edited by Ms. Jamie W. Leach of the WES Publications and Graphic Arts Division. The project was conducted under the general supervision of Dr. John Harrison, Chief, Environmental Laboratory; Dr. Raymond L. Montgomery, Chief, Environmental Engineering Division; and Mr. Norman Francingues, Chief, Water Supply and Waste Treatment Group. Director of WES during the course of this work was Col. Allen F. Grum, USA. Technical Director was Dr. Robert W. Whalin.

Preparation of this Handbook was aided greatly by the constructive contributions of the following reviewers:

Carlton Wiles	EPA, HWERL
Roy Murphy	EPA, OWPE
Ann Tate	EPA, CERI
Richard Stanford	EPA, OERR
Andrew T. McCord	Snyder, N. Y. 14226
Tom Ponder	PEDCo. Environmental, Inc.
Radha Krishnan	PEDCo. Environmental, Inc.

Janet M. Houthoofd of the Land Pollution Control Division, Hazardous Waste Engineering Research Laboratory, was the EPA project officer.

A major part of this study included the evaluation of equipment and processes applied to the solidification/stabilization of hazardous materials. The information contained herein could not have been compiled without the valuable assistance of a number of representatives from industry. The following industries are acknowledged for providing information and assistance:

Albert H. Halff Associates, Inc.
Consulting Engineers and Scientists
8616 Northwest Plaza Drive
Dallas, TX 75225
(214) 739-0094

Beardsley & Piper
Division of Pettibone Corp.
5501 W. Grand Avenue
Chicago, IL 60639
(312) 237-3700

American Resources Corporation
P.O. Box 813
Valley Forge, PA 19482-0813
(215) 337-7373

BFI Waste Systems
P.O. Box 3151
Houston, TX 77001
(713) 870-7857

Charles Ross & Son Company
710 Old Willets Path
Hauppauge, NY 11787
(516) 234-0500

Chemfix Technologies, Inc.
1675 Airline Highway
P.O. Box 1572
Kenner, LA 70063
(504) 467-2800

The Gorman-Rupp Company
305 Bowman Street
P.O. Box 1217
Mansfield, OH 44903
(419) 755-1011

Hittman Nuclear & Development
Corp.
9151 Rumsey Road
Columbia, MD 21045
(301) 730-7800

Mixing Equipment Co., Inc.
135 Mt. Read Blvd.
P.O. Box 1370
Rochester, NY 14603
(716) 436-5550

Rollins Environmental Services
P.O. Box 73877
Baton Rouge, LA 70807
(504) 778-1234

Soil Recovery, Inc.
101 Eisenhower Parkway
Roseland, NJ 07068
(201) 226-7330

Solidtek, Inc.
5371 Cook Road
P.O. Box 888
Morrow, GA 30260
(404) 361-6181

The Vaughan Pump Company, Inc.
364 Monte Elma Road
Montesano, WA 98563
(206) 249-402

The Vince Hagan Company
P.O. Box 5141
Dallas, TX 75222
(214) 339-7194

SECTION 1

INTRODUCTION

1.1 Background and Definitions

The terms "stabilization" and "solidification" are used in this Handbook as defined in the EPA publication, "Guide to the Disposal of Chemically Stabilized and Solidified Waste" (Malone et al. 1980). Both stabilization and solidification refer to treatment processes that are designed to accomplish one or more of the following results: (1) improve the handling and physical characteristics of the waste, as in the sorption of free liquids; (2) decrease the surface area of the waste mass across which transfer or loss of contaminants can occur; and/or (3) limit the solubility of any hazardous constituents of the waste such as by pH adjustment or sorption phenomena.

Stabilization techniques are generally those whose beneficial action is primarily through limiting the solubility or mobility of the contaminants with or without change or improvement in the physical characteristics of the waste. Examples include the addition of lime or sulfide to a metal hydroxide waste to precipitate the metal ions or the addition of an absorbent to an organic waste. Stabilization usually involves adding materials which ensure that the hazardous constituents are maintained in their least mobile or toxic form.

Solidification implies that the beneficial results of treatment are obtained primarily, but not necessarily exclusively, through the production of a solid block of waste material which has high structural integrity—a product often referred to as a "monolith." The monolith can encompass the entire waste disposal site—called a "monofill"—or be as small as the contents of a steel drum. The contaminants do not necessarily interact chemically with reagents, but are mechanically locked within the solidified matrix—called "microencapsulation." Contaminant loss is limited largely by decreasing the surface area exposed to the environment and/or isolating the contaminants from environmental influences by microencapsulating the waste particles. Wastes can also be "macroencapsulated," that is, bonded to or surrounded by an impervious covering. These techniques are also considered to be stabilization/solidification processes.

The term "fixation" has fallen in and out of favor, but is widely used in the waste treatment field to mean any of the stabilization/solidification

processes as described above; "fixed" wastes are those that have been treated in this manner.

Both solidification and chemical stabilization are usually included in commercial processes and result in the transformation of liquids or semi-solids into environmentally safer forms. For example, a metal-rich sludge would be considered stabilized if it were mixed with a dry absorber such as fly ash or dry soil. The benefits could be carried further if the sorbent and waste were then cemented into an impermeable, monolithic block. Or a waste would be considered chemically stabilized if the pH of the sludge were raised by the addition of lime ($\text{Ca}(\text{OH})_2$) so that potential contaminants such as toxic metals were less soluble and thus less easily leached.

1.2 Purpose and Scope of this Handbook

This Handbook provides guidance for the evaluation, selection, and use of stabilization/solidification technology as a remedial action alternative at uncontrolled, hazardous waste sites. The Handbook is designed to permit engineering personnel to proceed through concept development, determination of design requirements, and preliminary cost estimating for selected stabilization/solidification alternatives. A flow chart for evaluating considerations and procedures important to the stabilization/solidification option is shown in Figure 1-1.

The Handbook systematically reviews the technical basis for available stabilization/solidification systems, especially those suitable for onsite application at uncontrolled, hazardous waste sites. The general chemical systems involved in waste stabilization/solidification are discussed to provide the background information necessary for the selection of the optimum treatment system for a specific waste. Also described are the testing and analysis techniques commonly used to characterize a waste to aid in the selection of pretreatment and stabilization/solidification processes. The compatibility of specific classes of wastes and additives, and the testing systems needed for the evaluation of the stabilized/solidified wastes once treated are also reviewed.

Specific materials and equipment that are used in waste stabilization/solidification treatment and processing are discussed. Based on field surveys, four stabilization/solidification scenarios, including costs for materials, equipment, and operations associated with each, are developed and compared to provide a basis for planning-level cost evaluation of the many stabilization/solidification alternatives. Safety, environmental concerns, and cleanup and closure of waste processing and final disposal are considered.

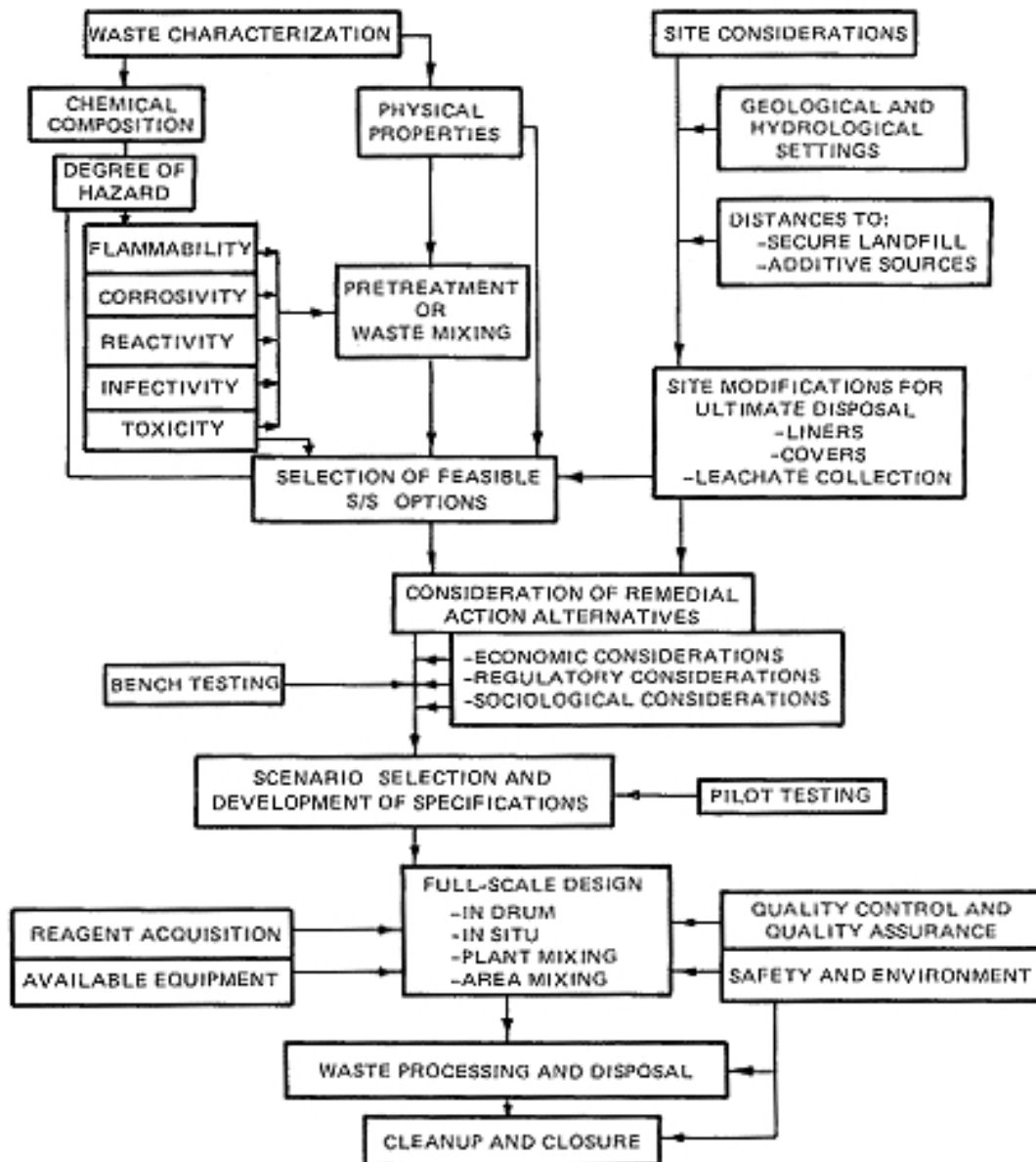

Figure 1-1. Flow chart for evaluating the stabilization/solidification (S/S) option.

1.3 Regulatory Basis for Use of Stabilization/Solidification

The EPA hazardous site cleanup program, referred to as Superfund, was authorized and established in 1980 by the enactment of the Comprehensive Environmental Response, Compensation, and Liability Act (CERCLA), Public Law (PL) 96-510. This legislation allows the Federal government (and cooperating State governments) to respond directly to releases and threatened releases of hazardous substances and pollutants or contaminants that may endanger public health or welfare or the environment. Prior to the passage of PL 96-510, the Federal authority with respect to hazardous substances was mostly regulatory through the Resource Conservation and Recovery Act (RCRA) and the Clean Water Act and its predecessors. The general guidelines and provisions for implementing CERCLA are given in the National Oil and Hazardous Substances Contingency Plan (NCP) (Federal Register, 40 CFR 300, 1982).

Three classes of actions are available when direct government action is called for:

- a. Immediate removals are allowed when a prompt response is needed to prevent harm to public health or welfare or to the environment. These are short-term actions usually limited to 6 months and a total expenditure of \$1 million.
- b. Planned removals are expedited, but not immediate, responses. These are intended to limit danger or exposure that would take place if longer term projects were implemented and responses were delayed.
- c. Remedial actions are longer term activities undertaken to provide more complete remedies. Remedial actions are generally more expensive and can only be undertaken at sites appearing on the National Priorities List of the NCP.

Remedial actions may present technically complex problems that are expensive to resolve. The selection of technical measures takes place only after a full evaluation of all feasible alternatives based upon economic, engineering, environmental, public health, and institutional considerations. Offsite transportation and disposal of waste is generally an expensive option and is justified only when proven cost-effective, and then only in facilities that comply with current hazardous waste disposal regulations under Subtitle C of RCRA.

Waste stabilization is specifically included in the NCP as a method of remedying releases of hazardous materials and controlling release of waste to surface water. Solidification and encapsulation are mentioned as techniques available for onsite treatment of contaminated soils and sediments. Under the general requirement to evaluate all alternatives for remedial action, it

will be necessary to evaluate the cost effectiveness of stabilization/solidification systems as applied to specific sites even if the technology is not selected in the final analysis of remedial techniques. Costs and engineering considerations are critical to these evaluations.

The performance expected from stabilized/solidified waste must also be as accurately assessed as possible. Cost estimates must take into consideration future expenditures needed to maintain the final waste disposal site after response work is complete. The NCP emphasizes the selection of reliable, tested remedial technologies. Examples of successful applications are an important part of any technical evaluation.

A further goal of this Handbook is to provide data necessary for the technical decisions required by law and for preliminary cost estimates. Other handbooks are available to supplement this document in developing plans for specific site activities. Overall guidance on remedial action technologies, including a survey of stabilization/solidification, is provided in a Technology Transfer Handbook by the EPA (U.S. EPA 1985a). The decision to implement the stabilization/solidification option must be preceded by the detailed investigation of many variables. Both waste and site characteristics must be evaluated to ensure that the stabilization/solidification alternative is cost-effective and environmentally acceptable. The U.S. EPA (1985b, 1985c) has provided general guidance on the procedure to be followed in selecting the most appropriate remedial actions.

REFERENCES

Federal Register. 1982. National Oil and Hazardous Substance Contingency Plan. (40 CFR 300), Volume 47, No. 137, July 16, 1982.

Malone, P. G., L. W. Jones, and R. J. Larson. 1980. Guide to the Disposal of Chemically Stabilized and Solidified Waste. SW-872, Office of Water and Waste Management, U. S. Environmental Protection Agency, Washington, D.C. 126 pp.

U.S. EPA. 1985a. Remedial Action at Waste Disposal Sites (Revised). EPA-625/6-85-006, U.S. Environmental Protection Agency, Cincinnati, Ohio. 497 pp.

U.S. EPA. 1985b. Guidance on Feasibility Studies under CERCLA. EPA-540/G-85-003. Office of Emergency and Remedial Response, U.S. Environmental Protection Agency, Washington, D.C.

U.S. EPA. 1985c. Guidance on Remedial Investigations under CERCLA. EPA-540/G-85-002. Office of Emergency and Remedial Response, U.S. Environmental Protection Agency, Washington, D.C.

SECTION 2

BASIS OF STABILIZATION/SOLIDIFICATION TECHNOLOGY

Stabilization processes and solidification processes have different goals. Stabilization systems attempt to reduce the solubility or chemical reactivity of a waste by changing its chemical state or by physical entrapment (microencapsulation). Solidification systems attempt to convert the waste into an easily handled solid with reduced hazards from volatilization, leaching, or spillage. The two are discussed together because they have the common purpose of improving the containment of potential pollutants in treated wastes. Combined processes are often termed "waste fixation" or "encapsulation."

Solidification of waste materials is widely practiced in the disposal of radioactive waste. Many developments relating to solidification originated in low-level radioactive waste disposal. Regulations pertaining to disposal of radioactive waste require that the wastes be converted into a free-standing solid with a minor amount of free water. Most processes used for nuclear waste include a step in which granular, ion exchange waste and liquids are incorporated in a solid matrix using a cementing or binding agent (for example, Portland cement, organic polymers, or asphalt). The resulting block of waste, with relatively low permeability, reduces the surface area across which the transfer of pollutants can occur. No such requirement for producing a free-standing solid exists for hazardous waste disposal, and solidification usually involves only the addition of an absorbent (without a binding agent) to produce a finely particulate waste that has no free liquid.

Waste stabilization has also been practiced in radioactive waste disposal and has involved processes such as (1) selecting inert, nondegrading sorbents that take up and retain specific radionuclides, (2) adjusting pH and oxidation-reduction conditions in the waste to prevent waste solubilization in ground water, and (3) using zeolites rather than biodegradable organic polymers as ion exchange media.

In hazardous waste disposal, an effort is usually made to have the treated waste delisted, usually by passing the EPA Extraction Procedure (EP) leaching test. To accomplish this goal, a variety of strategies may be used to prevent contaminant leaching, including neutralization, oxidation/reduction, physical entrapment, chemical stabilization, and binding of the stabilized solid into a monolith. The development of an appropriate treatment strategy includes the following considerations:

- a. The waste should be treated to obtain the most inert and insoluble form chemically and economically feasible.

- b. Media should be added to absorb any free liquid present.
- c. When necessary, a binding agent should also be added.

The binding agent may be selected to stabilize the waste further, for example the addition of alkalinity in portland cement. In cases where the waste is extremely soluble or no suitable chemical binder can be found, the waste may be contained by encapsulation in some hydrophobic medium, such as asphalt or polyethylene. This may be done either by incorporating the waste directly in the partially molten material or by forming jackets of polymeric material around blocks of waste.

Several generic treatment systems have been developed for waste stabilization and solidification, but not all have been employed in remedial action on uncontrolled waste sites. The volumes of waste involved at uncontrolled waste sites generally require that only the least expensive systems that are effective be used. The large quantities and varieties of wastes that are usually present also require the use of adaptable systems that are effective over a wide range of conditions. The treatment systems that generally satisfy these needs are the pozzolan- or Portland-cement-based systems. Inexpensive absorber materials such as clay, native soil, fly ash, or kiln dust may also be added. Under specific circumstances, it may be necessary to select other systems that offer particular advantages such as improved waste containment or compatibility with specific wastes. This Handbook concentrates on the major stabilization/solidification systems that can be applied inexpensively to a wide variety of wastes. Systems that have limited application to mixed wastes (such as glassification or organic polymers) or systems that require specific waste materials (such as self-cementation in sulfate waste) are covered in other references such as Malone et al. (1980), Malone and Jones (1979), and Iadevaia and Kitchens (1980).

2.1 Types of Treatment Reagents and Processes

Most stabilization/solidification systems being marketed are proprietary processes involving the addition of absorbents and solidifying agents to a waste. Often the marketed process is changed to accommodate specific wastes. Since it is not possible to discuss completely all possible modifications to a process, discussions of most processes have to be related directly to generic process types. The exact degree of performance observed in a specific system may vary widely from its generic type, but the general characteristics of a process and its products can be discussed. Comprehensive general discussions of waste stabilization/solidification are given in Malone et al. (1980), Malone and Jones (1979), and Iadevaia and Kitchens (1980).

Waste stabilization/solidification systems that have potentially useful application in remedial action activities and are discussed in detail here include:

- a. Sorption
- b. Lime-fly ash pozzolan processes
- c. Pozzolan-portland cement systems
- d. Thermoplastic microencapsulation
- e. Macroencapsulation.

Other technologies such as fusing waste to a vitreous mass or using self-cementing material are too specialized or not sufficiently field applicable to be used at present (Malone et al. 1980).

Sorption involves adding a solid to soak up any liquid present, and it may produce a soil-like material. The major use of sorption is to eliminate all free liquid. Nonreactive, nonbiodegradable materials are most suitable for sorption. Typical examples are activated carbon, anhydrous sodium silicate, various forms of gypsum, celite, clays, expanded mica, and zeolites. Some sorbents are pretreated to increase their activity toward specific contaminants and many are sold as proprietary additives in commercial processes.

Lime/fly ash pozzolanic processes use a finely divided, noncrystalline silica in fly ash and the calcium in lime to produce low-strength cementation. The waste containment is produced by entrapping the waste in the pozzolan concrete matrix (microencapsulation).

Pozzolan-Portland systems use Portland cement and fly ash or other pozzolan materials to produce a stronger type of waste/concrete composite. The waste containment is produced by microencapsulation in the concrete matrix. Soluble silicates may be added to accelerate hardening and metal containment.

Thermoplastic microencapsulation involves blending fine particulate waste with melted asphalt or other matrix. Liquid and volatile phases associated with the wastes are driven off, and the wastes are isolated in a mass of cooled, hardened asphalt. The material can be buried with or without a container.

Macroencapsulation systems contain a waste by isolating large masses of waste using some type of jacketing material. The most carefully researched systems use a 208-l drum or a polyethylene jacket fused over a monolithic block of solidified wastes.

2.1.1 Sorption

2.1.1.1 General

Most waste materials considered for stabilization/solidification are liquids or sludges (semisolids). To prevent the loss of drainable liquid

and improve the handling characteristics of the waste, a dry, solid absorbent is generally added to the waste. The sorbent may interact chemically with the waste or may simply be wetted by the liquid part of the waste (usually water) and retain the liquid as part of the capillary liquid. Figure 2-1 illustrates five common mechanisms by which sorbents can interact and immobilize small, polar molecules like water or charged ions on their surface or interstices, or react chemically to form new products.

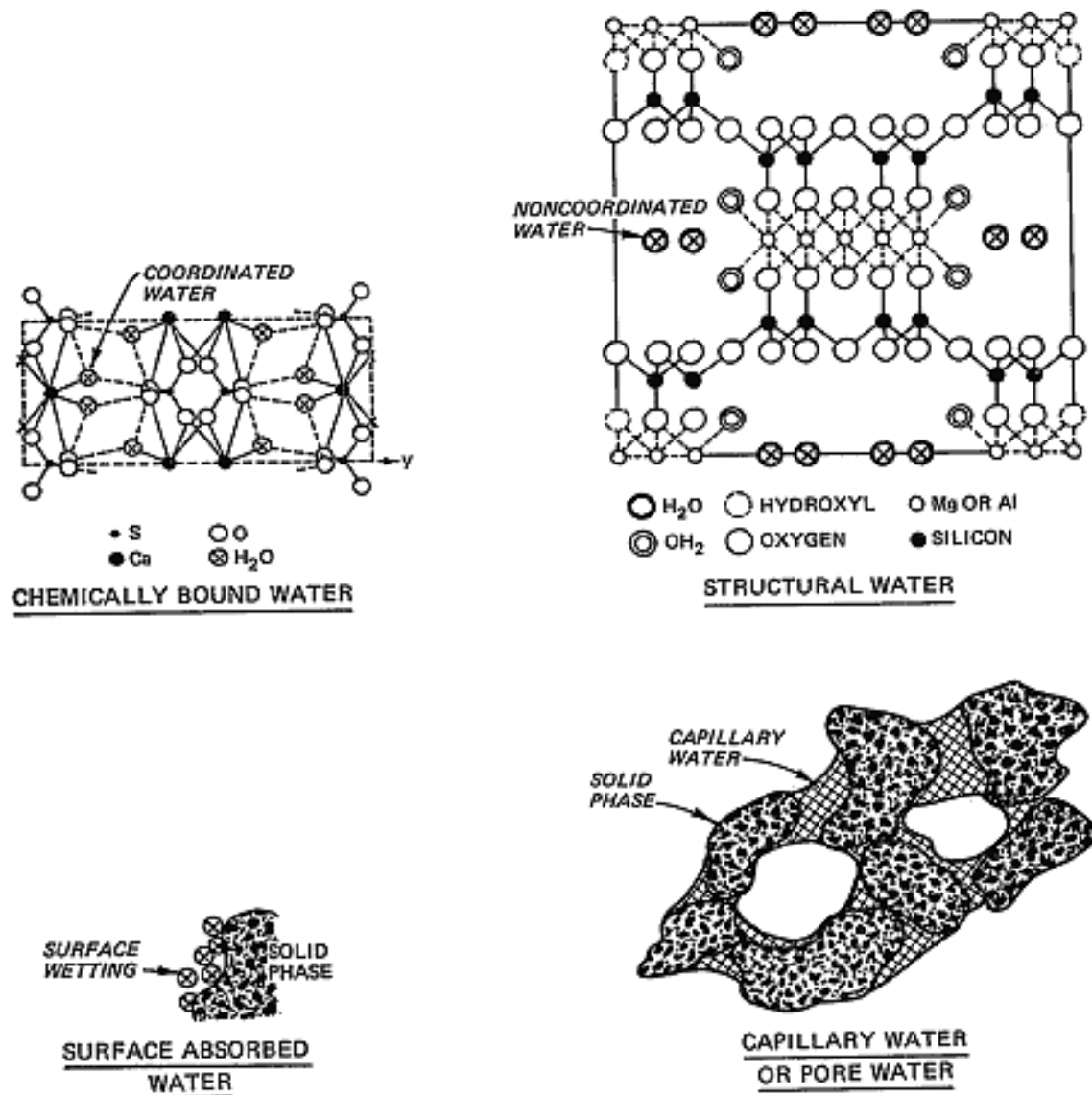

Figure 2-1. Mechanisms retaining water and ionic materials on and in solid phases.

The most common sorbents used with waste include soil and waste products such as bottom ash, fly ash, or kiln dust from cement and lime manufacture. In general, selection of sorbent materials involves trade-offs among chemical effects, costs, and amounts required to produce a solid product suitable for burial. Table 2-1 summarizes chemical binding properties of natural sorbents for selected waste leach liquids. Where the ability of a sorbent to bind particular contaminants is important to containment, sorbents with specific chemical affinities can be selected (Table 2-2). The pH of the waste strongly affects sorption/waste interactions, and pH control is an important part of any sorption process.

Artificial materials have also been advocated for use as sorbents in solidification; however, the relatively high cost of these materials has prevented their widespread use. Synthetic materials have generally found use where the binding of a specific contaminant in the waste is of paramount importance. Table 2-3 lists several synthetic sorbent materials that have been developed or tested for use with hazardous wastes.

Several major technical considerations are important in selecting a sorbent:

- a. Quantity needed to satisfy the requirement for having no free liquid.
- b. Compatibility or reactivity of the waste and the sorbent.
- c. Level and character of contamination that might be introduced in the sorbent.
- d. Chemical binding properties of sorbent for specific contaminants.

The quantity of absorbent necessary for sorbing all of the liquid in a waste to ensure that no free liquid is available varies widely depending on the nature of the liquid phase, the original solids content of the waste, the moisture level in the sorbent, and the availability of any chemical reactions that take up liquids during reaction. The high degree of variability seen in sorbents, and the changes in moisture content that can be brought about by storage and aging of sorbents, make it necessary to test sorbent batches on a bench scale rather than accepting specific ratios of sorbent-to-waste as constant. Typically when fly ash or kiln dust is being used to sorb an oil sludge (50% oil, 20% water), soil, fly ash, or kiln dust ratios of 1:1 (absorbent-to-sludge) up to 2.5:1 would be satisfactory. In field practice, extra sorbent is usually supplied. A program for testing sorbed waste for release of free liquid should be a standard part of sorption operations.

The ideal sorbent is an inert, nondegradable, nonreactive material. Though some sorbents are relatively inert, undesirable, or even hazardous, reactions can occur unless attention is paid to the potential for waste and sorbent to react. Table 2-4 lists a few of the possible reactions that should be considered when selecting sorbents.

TABLE 2-1. TYPICAL PHYSICAL AND CHEMICAL PROPERTIES OF COMMONLY USED NATURAL SORBENTS

Sorbent	Bulk density (kg/m ³)	Cation-exchange capacity (meq/100 gms)	Anion-exchange (meq/100 gms)	Slurry pH	Major mineral species present
Fly ash, acidic	1187	--	--	4-5	Amorphous silicates, hematite, quartz, mullite, free carbon
Fly ash, basic	1187	--	--	9-10	Calcite, amorphous silicates, quartz, hematite, mullite, free carbon.
Kiln dust	641-890	--	--	9-11	Calcite, quartz, lime (CaO) anhydrite.
Limestone screenings	--	--	--	6-7	Calcite, dolomite.
Clay minerals (soils)	1519			--	Various (e.g., illite)
Kaolinite		5-15	6-20		Can be relatively pure kaolinite.
Vermiculite		100-500	4	--	Can be relatively pure.
Bentonite		100-120	--	--	Smectite, quartz, illite, gypsum, feldspar, kaolinite, calcite.
Zeolite	1543	100-300	--	--	Zeolite (e.g., heulandite, laumontite, stilbite, chabazite, etc.)

From: Sheih (1979), Haynes and Kramer (1982), Grim and Guven (1978).

TABLE 2-2. NATURAL SORBENTS AND THEIR CAPACITY FOR REMOVAL OF SPECIFIC CONTAMINANTS FROM LIQUID PHASES OF NEUTRAL, BASIC, AND ACIDIC WASTES

Contaminant	Neutral waste (calcium fluoride)		Basic waste (metal finishing sludge)		Acidic waste (petroleum sludge)	
Ca	Zeolite	(5054)*	Illite	(1280)	Zeolite	(1390)
	Kaolinite	(857)	Zeolite	(1240)	Illite	(721)
			Kaolinite	(733)	Kaolinite	(10.5)
Cu	Zeolite	(8.2)	Zeolite	(85)	Zeolite	(5.2)
	Kaolinite	(6.7)	Kaolinite	(24)	Acidic F.A.	(2.4)
	Acidic F.A.†	(2.1)	Acidic F.A.	(13)	Kaolinite	(0)
Mg	Basic F.A.	(155)	Zeolite	(1328)	Zeolite	(746)
			Illite	(1122)	Illite	(110)
			Basic F.A.	(176)	Basic F.A.	(1.7)
Zn					Zeolite	(10.8)
					Vermiculite	(4.5)
					Basic F.A.	(1.7)
Ni			Zeolite	(13.5)		
			Illite	(5.1)		
			Acidic F.A.	(3.8)		
F	Illite	(175)	Kaolinite	(2.6)	Illite	(9.3)
	Kaolinite	(132)	Illite	(2.2)	Acidic F.A.	(8.7)
	Acidic F.A.	(102)			Kaolinite	(3.5)
Total CN-					Illite	(12.1)
					Vermiculite	(7.6)
					Acidic F.A.	(2.7)
COD	Acidic F.A.	(690)	Illite	(1744)	Vermiculite	(6654)
	Illite	(108)	Acidic F.A.	(1080)	Illite	(4807)
			Vermiculite	(244)	Acidic F.A.	(3818)

* Bracket represents sorbent capacity in micrograms of contaminant removed per gram of sorbent used. After Sheih (1979) and Chan et al. (1978).

† F.A. = fly ash.

TABLE 2-3. SYNTHETIC SORBENTS USED WITH HAZARDOUS WASTES

Sorbent	Waste treated effectively
Activated alumina	Sorbs fluoride in neutral wastes
Activated carbon	Sorbs dissolved organics
Hazorb*	Sorbs water and organics
Locksorb†	Oil emulsions
Imbiber beads‡	Inert spirits-type liquids (cyclohexane)

* Product of Diamond Shamrock Corp.

† Product of Radecca Corp., Austin, TX.

‡ Product of Dow Chemical Co., Midland, MI.

Sources: Product literature, Pilie et al. (1975), and Shieh (1979).

TABLE 2-4. UNDESIRABLE SORBENT/WASTE REACTIONS

Sorbent	Waste type	Reaction
Acidic sorbent	Metal hydroxide	Solubilizes metal
Acidic sorbent	Cyanide	Releases hydrogen cyanide
Acidic sorbent	Sulfide	Releases hydrogen sulfide
Alkaline sorbent	Ammonium compounds	Releases ammonia gas
Alkaline sorbent (with carbonates such as calcite or dolomite)	Acid waste	Releases carbon dioxide, which can cause frothing
Carbonaceous sorbent (carbon, cellulose)	Oily waste	May create pyrophoric waste
Siliceous sorbent (soil, fly ash)	Hydrofluoric acid	May produce soluble fluorosilicates

2.1.1.2 Usefulness

Sorption has been widely used to eliminate free water and improve handling. Some sorbents have been used to limit the escape of volatile organic compounds. Sorbents may also be useful in waste containment when they modify the chemical environment and maintain the pH and redox potential to limit the solubility of the waste.

2.1.1.3 Limitations

Sorption eliminates the bulk flow of wastes from the site, but in many cases leaching of waste constituents from the sorbent can be a significant source of pollution. Sorbents are widely used in lined landfills to eliminate or control the pressure head on the liner, but the liner is the major protection for the surrounding environment.

2.1.1.4 Equipment Requirements

Sorption of wastes requires only that the waste be mixed with the sorbent. This can be done with nothing more than a mixing pit and a backhoe. More elaborate equipment such as a pug mill or ribbon blender can be used if better quality control is needed and if other materials handling equipment (pumps or conveyors) is available.

2.1.1.5 Applications

Most large, hazardous waste landfills are currently using sorption to satisfy requirements prohibiting burial of liquids. A discussion of successful application of sorption in waste disposal is presented in Morgan et al. (1982) and summarized in U.S.EPA (1984). Nineteen million liters (5 million gal) of oil sludge from a former refinery site was landfilled onsite after treatment with cement kiln dust. The process required 3.71×10^7 kg (40,939 tons) of kiln dust. The mixing was done primarily with standard construction equipment at a cost of approximately \$15 per cubic meter.

2.1.2 Lime/Fly Ash Pozzolan Treatment Process

2.1.2.1 General

Pozzolanic materials are those that set to a solid mass when mixed with hydrated lime. Natural pozzolanic materials (called pozzolana) consist of

either volcanic lava masses (tuff) or deposits of hydrated silicic acid of mostly organic origin (e.g., diatomaceous earth); these are the "natural cements" used by the Romans to produce their famous, long-enduring aqueducts. Artificial pozzolana are materials such as blast-furnace slag, ground brick, and some fly ashes from powdered coal furnaces. A common feature of all pozzolana is the presence of silicic acid (i.e. silicic mineral components that can react with lime) and frequently appreciable levels of aluminum oxide. Portland cement differs from pozzolana in that it is a defined mixture of powdered oxides of calcium, silica, aluminum, and iron which result from the kiln burning (at 1400-1500° C) of raw material such as limestone and clay (marl).

Solidification/stabilization of waste using lime and pozzolanic material requires that the waste be mixed with a carefully selected, reactive fly ash (or other pozzolanic material) to a pasty consistency. Hydrated lime (calcium hydroxide) is blended into the waste-fly ash mixture. Typically, 20 to 30% lime is needed to produce a strong pozzolan. The resulting moist material is packed or compressed into a mold to cure or is placed in the landfill and rolled.

Standard testing systems (ANSI/ASTM C-311-77) and standard specifications (ASTM C618-80) exist for pozzolanic materials, especially for fly ash (ASTM 1973). The specifications take into account both the chemical composition ($\%SiO_2$, $\%SO_3$, and moisture content) and physical properties (fineness, pozzolanic activity with lime, specific gravity). By using fly ash that meets the specification for a bituminous coal fly ash (Type F) or a sub-bituminous coal fly ash (Type C), pozzolanic activity greater than a specified minimum can be guaranteed. Type C fly ashes have enough lime (more than 10% $Ca(OH)_2$) that they are not only pozzolanic but are also self-cementing.

2.1.2.2 Usefulness

Lime/fly ash treatment is relatively inexpensive, and with careful selection of materials an excellent solid product can be prepared. In general, fly ash/lime solidified wastes are not considered as durable as pozzolan-Portland cement composites (Malone et al. 1980). Leaching losses from pozzolan-waste materials have been considered to be relatively high compared with those for pozzolan-Portland cement waste products (Malone et al. 1983). In diffusion-type leach testing of a variety of solidified waste produced from a standard metal-rich waste, the lime-fly ash based material prepared from a metal solution or a liquid sludge showed levels of containment that were as good as any pozzolan-Portland cement treated waste. However, the sample of lime/fly-ash-treated waste disintegrated in the leaching solution (Cote and Hamilton 1983).

Table 2-5 estimates the quantity of additives required per unit volume of waste for adequate treatment of six different waste types. This table is furnished to provide an example of an application, not design information.

Note that when waste lime was used, the materials requirement increased 60% to 70%. Bentonite addition reduced substantially the amount of fly ash required.

TABLE 2-5. APPROXIMATE REAGENT REQUIREMENTS FOR SOLIDIFICATION OF VARIOUS WASTE TYPES USING LIME AND FLY ASH*

Waste	Commercial lime (kg/l)	Waste lime (kg/l)	Lime, fly ash, and bentonite† (kg/l)
Spent brine	3.2	5.4	2.2
Metal hydroxide sludge	2.9	5.6	1.1
Copper pickle liquor sludge	1.8	2.6	0.7
FeCl ₂ pickle liquor sludge (>1.5% HCl)	2.5	4.0	1.9
Sulfuric acid plating waste (>15% H ₂ SO ₄)	3.0	5.2	2.3
Oily metal sludge (oil and grease)	0.6	0.84	0.54

* After Stanczyk et al. (1982).

† Proportions not specified.

2.1.2.3 Limitations

Common problems with lime-pozzolan reactions involve interference with the cementitious reaction that prevents bonding of materials. The bonds in pozzolan reactions depend on the formation of calcium silicate and aluminate hydrates. A number of materials (such as sodium borate, calcium sulfate, potassium bichromate, and carbohydrates) can interfere with this reaction. Oils and greases can also physically interfere with bonding by coating waste particles. The cementing system is strongly alkaline and can react with certain waste to release undesired materials such as gas or in leachate.

2.1.2.4 Equipment Requirements

The use of the lime/fly ash pozzolan processes requires more complex equipment than systems using sorbent materials only. In one treatment system

used for open sludge ponds, fly ash is mixed with a waste using a backhoe to form a moist mass that can be easily handled with a shovel. The waste/fly ash mixture is then loaded onto a weighing conveyor, and a metered amount of lime is added. The mixture is run through a pug mill and loaded for placement in a landfill. Other systems pump the sludge directly into a pug mill or ribbon blender, where the reagents are blended; they then pump the treated product directly to the final disposal area.

2.1.2.5 Applications

Lime/fly ash stabilization/solidification systems have been successfully used in managing hazardous wastes. However the containment performance generally is such that a hazardous waste would still be classed as hazardous after processing. Lime/fly ash-sorbent-based landfills have been established using liner and monitoring systems to ensure safe disposal.

2.1.3 Pozzolan-Portland Cement Systems

2.1.3.1 General

A wide variety of treatment processes incorporate Portland cement as a binding agent. Pozzolanic products (materials with fine-grained, noncrystalline, reactive silica) are frequently added to Portland cement to react with any free calcium hydroxide and thus improve the strength and chemical resistance of the concrete-like product. In waste solidification, the pozzolanic materials (such as fly ash) are often used as sorbents. Much of the pozzolan in waste processing may be inactivated by the waste. Any reaction that does occur between the Portland cement and free silica from the pozzolan adds to the product strength and durability.

Waste-solidifying formulations based on Portland and pozzolan-Portland systems vary widely, and a variety of materials have been added to change performance characteristics. These include soluble silicates (Falcone et al. 1983), hydrated silica gels, and clays such as bentonite, illite, or attapulgite. Approximate reagent requirements for some example applications are given in Table 2-6.

The types of Portland cement used for solidification can be selected so as to emphasize a particular cementing reaction (Bogue 1955). Five major types of Portland cement are commonly produced:

- a. Type I is the typical cement used in the construction industry. It constitutes more than 90% of the cement manufactured in the United States.

TABLE 2-6. APPROXIMATE PORTLAND CEMENT AND FLY ASH REQUIREMENTS FOR SOLIDIFICATION OF VARIOUS WASTE TYPES*

Waste	Cement/fly ash (kg/l waste)
Spent brine	3.8
Metal hydroxide sludge	2.4
Copper pickle liquor sludge	1.9
FeCl ₂ pickle liquor sludge (>1.5% HCl)	3.5
Sulfuric acid plating waste (>15% (H ₂ SO ₄))	3.8
Oily metal sludge	0.96

* After Stanczyk et al. (1982). The proportion of portland cement to fly ash was not given.

- b. Type II is designed to be used in the presence of moderate sulfate concentrations (150 to 500 mg/kg), or where moderate heat of hydration is required. Type II has a low-alumina-content (less than 6% Al₂O₃) cement.
- c. Type III has a high early strength and is used where a rapid set is required.
- d. Type IV develops a low heat of hydration and is usually prescribed for large-mass concrete work. This type typically has a long set time.
- e. Type V is a special low-alumina, sulfate-resistant cement used with high sulfate concentrations (i.e more than 1500 mg/kg).

Type I Portland cement is widely used for waste solidification due to its availability and low cost. Types II and V have been used to a limited extent. They offer the advantage of having relatively low tricalcium aluminate content. Higher aluminum-content cement can undergo a rapid reaction with sulfates (Na₂SO₄, K₂SO₄, (NH₄)₂SO₄, and MgSO₄) from a waste or surrounding ground water to form crystals of hydrated calcium aluminosulfate. The reaction products occupy a much larger volume than the original

calcium aluminate hydrate and the expansion cracks the curing waste/concrete mass.

Cement/fly ash processes typically are used in conjunction with sorbents or other additives which decrease the loss of specific hazardous materials from the rather porous, solid products. Such adaptations of the technology are also often necessary because some materials inhibit the binding action in Portland cement. Additives used in Portland cement have included:

- a. Soluble silicates, such as sodium silicate or potassium silicate. These agents will generally "flash set" Portland cement to produce a low-strength concrete. Research with soluble silicates indicates that these materials are beneficial in reducing the interference from metal ions in the waste solution (Columbo and Neilson 1978; Falcone et al. 1983).
- b. Selected clays to absorb liquid and bind specific anions or cations. Work with bentonite as an additive indicates that they reduce the amount of absorbent required in low-solids mixtures (Stanczyk et al. 1982).
- c. Emulsifiers and surfactants to allow the incorporation of immiscible organic liquids. Research in the nuclear waste field has indicated that waste turbine oil and grease can be mixed into cement blends if dispersing agents are used and if the proper mixing system is employed, but process details were not discussed (Phillips 1981).
- d. Proprietary absorbents that selectively bind specific wastes. These materials include carbon, silicates, zeolitic materials, and cellulosic sorbents; they hold toxic constituents and are encapsulated with the waste.
- e. Lime (CaO) to raise the pH and the reaction temperature and thereby improve setting characteristics.

2.1.3.2 Usefulness

Cement-based solidification and stabilization systems have proved to be some of the most versatile and adaptable methods. Waste/concrete composites can be formed that have exceptional strength and excellent durability, and that retain wastes very effectively (Malone et al. 1980). The addition of selected sorbents and/or emulsifiers often overcomes the problem of pollutant migration through the rather porous solid matrix and consequently lowers the leaching losses from the treated wastes.

2.1.3.3 Limitations

Pozzolan-Portland cement wastes have limitations that relate to the effects of the waste on the setting (retardation from calcium sulfate, borates, carbohydrates, etc.) and stability of the silicates and aluminates that form when portland cement hydrates. Additionally other materials such as oil and grease or large amounts of soft, fine wastes can prevent bonding of particles in the waste and lower strength. Acidic or acid-producing materials such as sulfides can react with carbonate and hydroxides and destroy concrete after setting has occurred.

The very high alkalinity of hydrating Portland cement can cause the evolution of ammonia gas if ammonium ion is present in abundance in the waste. Some metals have increased solubility at the very high pH's that occur in the cement hydration reaction (e.g. nickel, lead, and zinc).

2.1.3.4 Equipment Requirements

Commercial cement mixing and handling equipment can generally be used with wastes. Weighing conveyors, metering cement hoppers, and mixers similar to concrete batching plants have been adapted in some operations. Unless severe corrosion occurs, no adaptation of equipment is required. Where extremely dangerous materials are being treated, remote-control, in-drum mixing equipment such as that used with nuclear waste can be employed.

2.1.3.5 Applications

A number of commercial solidification vendors are currently operating using variations of pozzolan-Portland cement systems. Many use specific sorbents, additives, and proprietary formulations developed to answer the needs of specific clients.

2.1.4 Thermoplastic Microencapsulation

2.1.4.1 General

Thermoplastic microencapsulation has been successfully used in nuclear waste disposal and can be adapted to special industrial wastes. The technique for isolating the waste involves drying and dispersing it through a heated, plastic matrix. The mixture is then permitted to cool to form a rigid but deformable solid. In most cases it is necessary to use a container such as a fiber or metal drum to give the material a convenient shape for transport. The most common material used for waste incorporation is

asphalt; but other materials such as polyethylene, polypropylene, wax, or elemental sulfur can be employed for specific wastes where complete containment is important and cost is not a limiting factor.

2.1.4.2 Usefulness

The major advantage that thermoplastic (asphalt) encapsulation offers is the ability to solidify very soluble, toxic materials. This is a unique advantage that cement and pozzolan systems cannot claim. If, for example, the wastes are spray-dried salt, there are few useful alternatives to microencapsulation. The asphalt encapsulation process can be used with moist salt and the mixer-extruder can be used to remove (and recover, if necessary) water or other solvents associated with the wastes. Drying the waste results in a substantial weight reduction over the original material and partly compensates for the additional weight of the asphalt matrix.

2.1.4.3 Limitations

Compatibility of the waste and the matrix becomes a major consideration in using thermoplastic microencapsulation. Most matrices employed with wastes are reduced materials (solid hydrocarbons or sulfur) that can react (combust) when mixed with an oxidizer at elevated temperatures. The reaction can be self-sustaining or even explosive if perchlorates or nitrates are involved.

Other compatibility problems relate to unusual softening or hardening of the waste/matrix mix. Some solvents and greases can cause asphalt materials to soften and never become rigid solids. Borate salts can cause hardening at high temperatures and can stall or clog mixing equipment. Xylene and toluene diffuse quite rapidly through asphalt.

Salts that partially dehydrate at the elevated temperatures used in mixing can be a problem. Sodium sulfate hydrate, for example, will lose some water during asphalt incorporation and if the waste/asphalt mix containing the partially dehydrated salt is soaked in water, the mass will swell and crack due to rehydration. This outcome can be avoided by eliminating easily dehydrated salts or by coating the outside of the asphalt/waste mass with pure asphalt (Doyle 1979). Chelating and complexing agents (cyanides and ammonium compounds) in waste have been shown to seriously compromise the containment of heavy metal wastes (Rosencrance and Kulkarni 1979). If care is taken to pretreat the waste to eliminate oxidizers and destroy complexing agents, the containment of the waste in asphalt is superior to pozzolan or pozzolan-Portland cement solidification.

Thermoplastic encapsulation requires complex, specialized mixing equipment and a trained operations staff to ensure safe, consistent operation. The requirement for drying the waste and melting the matrix material makes

the power consumption for waste solidification quite high compared with that for pozzolan and pozzolan-Portland cement systems.

2.1.4.4 Equipment Requirements

Specialized equipment is required to ensure thorough mixing of the viscous material under controlled temperature conditions. The mixers or extruders used in waste solidification are similar to those used in the plastic industry where coloring and filler materials are generally added to raw plastics. When hazardous wastes are treated, the waste materials replace the filler. Temperatures ranging from 130° to 230° C are used during mixing.

Screw-extruders that are routinely used in preparation of plastics for molding are the major type of equipment used in waste microencapsulation. These systems have staged heating and kneading of the waste and matrix material to ensure homogeneous blending of waste and matrix. Waste treatment systems are adapted from standard extruders by adding fume control, safety equipment interlocks, and systems for handling wastes without exposing the operators to undue hazard.

2.1.4.5 Applications

Thermoplastic microencapsulation has been widely used in nuclear waste disposal, and application to industrial waste disposal has been projected, for instance, in disposal of arsenical wastes. Success with nuclear waste disposal has been well documented (Doyle 1979).

2.1.5 Macroencapsulation or Jacketing Systems

2.1.5.1 General

Macroencapsulation systems contain potential pollutants by bonding an inert coating or jacket around a mass of cemented waste or by sealing them in polyethylene-lined drums or containers. This type of waste stabilization is often effective when others are not because the jacket or coating of the outside of the waste block completely isolates the waste from its surroundings. The waste may be stabilized, microencapsulated, and/or solidified before macroencapsulation so that the external jacket becomes a barrier designed to overcome the shortcomings of available treatment systems.

A macroencapsulation system that has been proposed for use with hazardous wastes involves drying the wastes and bonding the dried material into a compressed block using polybutadiene. Polymerization of the binder requires heating the waste sample to 120°C to 200°C under slight pressure. The block is placed in a mold and surrounded with powdered polyethylene. The

polyethylene is then fused into a solid jacket using heat and pressure. In the proposed system, a 3.5-mm-thick jacket would be fused over a 450-kg block. The polyethylene would amount to approximately 4% of the mass by weight (Lubowitz and Wiles 1978).

2.1.5.2 Usefulness

Macroencapsulation can be used to contain very soluble toxic wastes. Leaching of the waste can be eliminated for the life of the jacketing material. This process has been used at remedial sites as drum over-packs to contain weak or leaking drums and containers.

2.1.5.3 Limitations

In some systems, the wastes have to be dried before they are fused into a block, thus increasing the risk of the release of volatile toxics. Furthermore, the waste must not react with the binder or jacket materials at the elevated temperatures required for fusing and forming a jacket. The jacketing material may have to be protected from chemical or photo degradation or physical stresses after disposal. Equipment such as special molds on processing machinery is highly technical and requires highly skilled labor unless loose-fitting over-packs are used.

2.1.5.4 Equipment Requirements

Macroencapsulation requires special molds and heating equipment for fusing the waste and forming the jacket. Molding equipment would have to be custom fabricated for waste handling.

2.1.5.5 Application

Macroencapsulation has been bench tested on a number of different wastes, but it has not been tested in a full-scale operation (Lubowitz and Wiles 1979). Results of bench testing are encouraging, but larger-scale operations have not been pursued.

2.2 Compatibility of Wastes and Treatment Processes

The chemical reactivity of the waste generally controls the selection of waste stabilization/solidification options and its optimization. Table 2-7 summarizes the major chemical considerations that direct the selection of a

TABLE 2-7. COMPATIBILITY OF SELECTED WASTE CATEGORIES WITH DIFFERENT STABILIZATION/
SOLIDIFICATION TECHNIQUES

Waste component	Treatment Type			
	Cement based	Pozzolan based	Thermoplastic microencapsulation	Surface encapsulation
Organics				
Organic solvents and oils	May impede setting, may escape as vapor	May impede setting, may escape as vapor	Organics may vaporize on heating	Must first be absorbed on solid matrix
Solid organics (e.g., plastics, resins, tars)	Good--often increases durability	Good--often increases durability	Possible use as binding agent in this system	Compatible--many encapsulation materials are plastic
Inorganics				
Acid wastes	Cement will neutralize acids	Compatible, will neutralize acids	Can be neutralized before incorporation	Can be neutralized before incorporation
Oxidizers	Compatible	Compatible	May cause matrix breakdown, fire	May cause deterioration of encapsulation materials
Sulfates	May retard setting and cause spalling unless special cement is used	Compatible	May dehydrate and rehydrate causing splitting	Compatible
Halides	Easily leached from cement, may retard setting	May retard set, most are easily leached	May dehydrate and rehydrate	Compatible
Heavy metals	Compatible	Compatible	Compatible	Compatible
Radioactive materials	Compatible	Compatible	Compatible	Compatible

After Malone et al. (1980).

particular waste stabilization/solidification system. Most solidification systems will work under adverse circumstances if adaptations are made in the waste or the processing train. Many compatibility problems can be overcome by specifying pretreatment steps to destroy or tie up some undesirable waste constituent.

2.3 Pretreatment Techniques for Waste Solidification

Pretreatment systems, which overlap with stabilization and sorption processes, can be used to achieve a number of results that condition the waste to ensure better and more economical containment after the remaining materials have been stabilized and solidified. These include:

- a. Destruction of materials (such as acids or oxidizers) that can react with solidification reagents (lime or Portland cement).
- b. Reduction of the volume of waste to be solidified (using processes such as settling or dewatering).
- c. Chemical binding of specific waste constituents to solid phases added to scavenge toxic materials from solution and hold them in solids.
- d. Techniques for improving the scale on which waste processing can be done—for example, bulking and homogenizing waste to allow a single solidification system to be used without modification on a large volume of waste.

Neutralization, oxidation or reduction, and chemical scavenging stabilize the waste in that they bring the chemical waste into an inert or less soluble form. Dewatering, consolidation, and waste-to-waste blending are also useful pretreatment methods which reduce the waste volume or numbers of different waste forms requiring treatment.

2.3.1 Neutralization

Most binder systems can operate well with wastes that are approximately neutral (pH 7.0), though alkaline wastes are also desirable in many circumstances where it is necessary to minimize solubility. Many toxic metals are amphoteric (show increased solubility at both high and low pH's) and by adjusting the pH it is possible to produce a minimum amount of metal in the supernatant liquid (Figure 2-2). Depending upon the metals present, the optimum pH is usually between 9.5 and 11, which offers the advantage of requiring less treatment of the discharged water produced by subsequent dewatering.

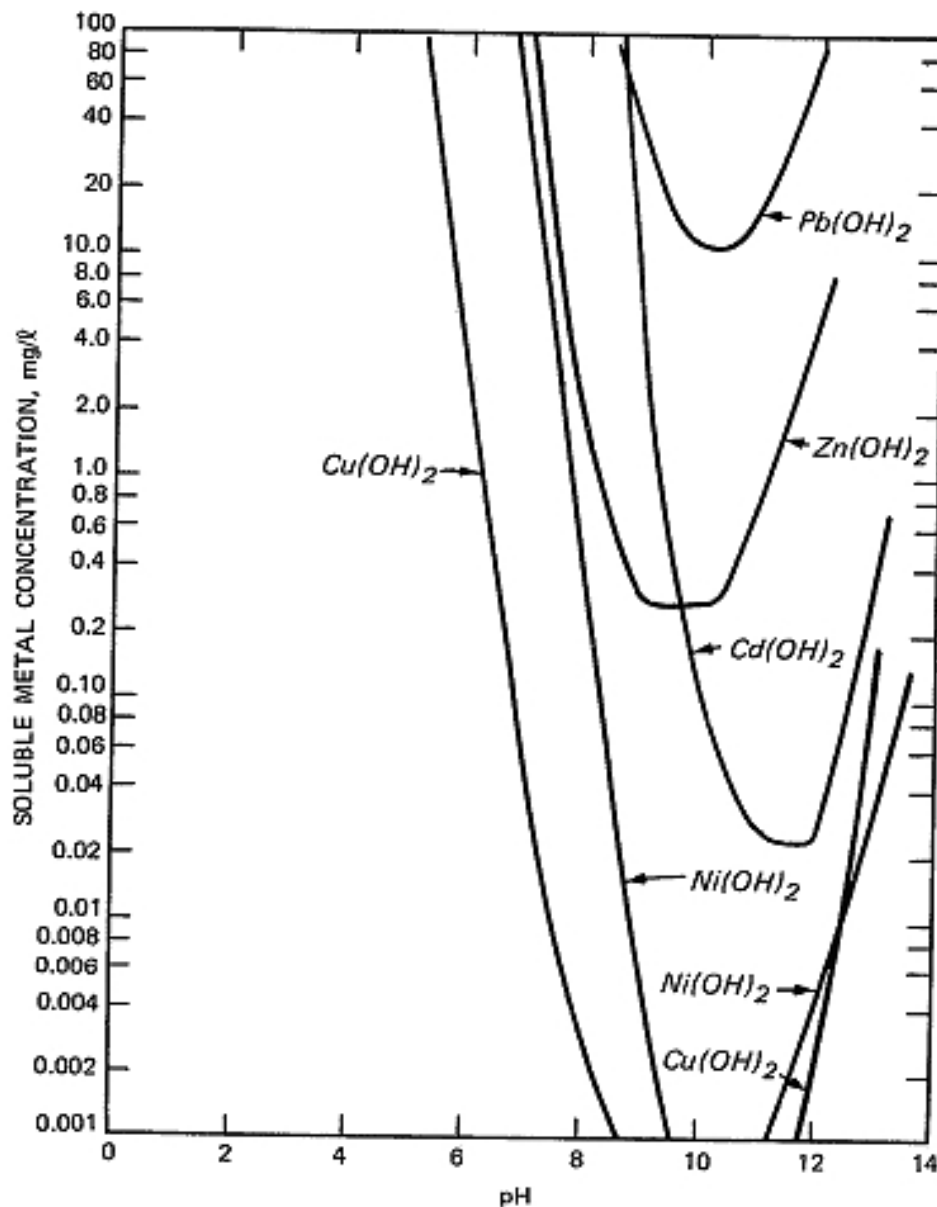

Figure 2-2. Theoretical solubilities of selected amphoteric metal hydroxides.

The selection of a neutralization agent is important in reducing the amount of leachable material in the waste. A common base used in neutralization is sodium hydroxide; however, resulting sodium salts typically have very high solubilities, and the supernatant liquid and sludge produced in neutralization will have higher levels of soluble materials than if other bases were used. Calcium hydroxide or calcium carbonate may be a better choice for neutralization because the resulting salts are generally less soluble than sodium salts. Calcium hydroxide and calcium carbonate also are available inexpensively in a relatively pure form.

Calcium carbonate offers the advantage that many carbonate metal salts are insoluble (for example, lead carbonate has a low solubility) and the carbonates are compatible with both Portland cement and pozzolan material. However, neutralization with carbonates can cause frothing due to evolution of carbon dioxide. Excess calcium hydroxide in Portland cement is thought to make the material more reactive to sulfate attack (Ramachandran 1976; Bogue 1955). In pozzolan materials, excess lime would react with free silica and should not pose a problem. DeRenzo (1978) and EPA (1982) discuss equipment needs and design for precipitation systems that use neutralization.

2.3.2 Oxidation/Reduction

In some cases, the most insoluble form of a toxic constituent is associated with a specific oxidation/reduction state. Iron, for example, is much less soluble at alkaline pH's in its oxidized state. Chromium in its oxidized state (Cr^{+6}) is more mobile than the reduced chromium (Cr^{+3}) in an alkaline solution.

The usual technique involved in oxidizing or reducing hazardous materials to a stable, insoluble state involves addition of hypochlorite, chlorate, persulfate chlorine or peroxide (oxidizers), or sulfides, ferrous salts, or sulfur dioxide gas (reducing agents). A discussion of oxidation-reduction systems along with equipment design is given in DeRenzo (1978), U.S. EPA (1982), and Nemerow (1971).

Oxidation of toxic organic constituents using UV-ozone or chemical oxidizers can lower the toxicity of the final product and the amount of fixation reagents required. And, of course, incineration can be considered an oxidative pretreatment because it usually generates a residue or scrubber sludge residual which often requires further treatment and disposal.

2.3.3 Chemical Scavenging

Chemical scavenging involves the use of some solid chemical agent to chemisorb or react with and bind up some specific waste constituent. This procedure is significantly different from adsorption, where the goal of the operation is to soak up free liquid and adsorb ions in solution. Chemical scavenging agents, many of which are proprietary, include chemically active adsorbents (for example, activated carbon), specific types of clays, ion exchange resins, natural and artificial zeolites, silica gels, and finely divided metal hydroxides (ferric hydroxide or aluminum hydroxide).

In all cases, an attempt should be made to ensure that the scavenging agent is compatible with the waste and the solidification reaction. Selected use of scavengers can greatly reduce the requirement to treat the discharge water after dewatering of the wastes. Scavenging can also assist in complicated treatment problems. For example, in the solidification of a paint

stripping waste that contained phenol and a chrome (Cr^{+3}) paint pigment, attempts to oxidize the phenol with permanganate also oxidized the chromium and increased its leaching. Without treatment, the phenol leaching rate was unacceptable. A suitable scavenging material such as formaldehyde would be able to react with the phenol and reduce its leaching rate while leaving the chromium in its lower (less soluble) valence state.

Scavenger materials often improve solidification performance without adding appreciably to the volume of the waste. Scavenging materials, such as flocculating agents like polyelectrolytes or aluminum hydroxide or iron hydroxide, also assist in waste concentration or dewatering by improving the settling characteristics of fine-grained wastes in suspension.

2.3.4 Dewatering and Consolidation

Solidification systems can be made more economical by reducing the volume of waste to be treated by dewatering. Dewatering can also be used to lower the water content of the solidified waste which, in turn, lowers the leachability of the waste. A strong correlation is found between the leachability and the water content of solidified waste, which indicates diffusion of contaminants probably occurs through the pore liquid in solidified waste matrices (Cote and Hamilton 1983); thus a dryer, solidified product will have lower contaminant mobility.

Design of dewatering systems is discussed in DeRenzo (1978) and EPA (1982). A comparison of stabilization of dewatered and undewatered industrial sludge reported by Cote and Hamilton (1983) indicated the final volume after dewatering for a typical metal hydroxide waste was about 35% of the initial volume. Dewatering the metal waste increased containment (as measured by diffusion testing) and decreased costs due to lower fixation reagent requirements and less final product requiring disposal.

2.3.5 Waste-to-Waste Blending

Except in the case of extremely toxic wastes, it is generally not practical to set up stabilization/solidification systems to handle small volumes of waste, especially if the wastes vary significantly in their compatibility and containment performance in a selected process. At some point in the remedial action planning it is necessary to mix or bulk wastes in order to obtain sufficient volume for efficient pretreatment, stabilization, and/or solidification. If the nature of the waste permits bulk mixing before a treatment, then a simpler, large-scale pretreatment operation can be undertaken and a large mass of homogeneous material (feed stock) will be available for processing. Guidelines for mixing or bulking of wastes are given in Chemical Manufacturers Association (1982) and in Hatayma et al. (1981). The water separation and blending systems depend on identifying materials that have similar composition and pH and oxidation/reduction characteristics.

This same type of waste classification and blending is needed to develop feed stocks for pretreatment as well as to provide economy by processing large volumes.

When the reactions between different types of wastes (for example, acids and bases, or oxidizers and reducers) can be controlled and no unwanted side reactions occur (such as generation of H_2S or HCN gas), the waste blending becomes a treatment step where the wastes themselves are treatment reagents. Blended waste can then be further treated if additional pH adjustment or oxidation-reduction treatment is needed.

REFERENCES

- American Society for Testing and Materials (ASTM). 1973. Annual Book of ASTM Standards, Part II. American Society for Testing and Materials, Philadelphia, Pennsylvania.
- Bogue, R. H. 1955. The Chemistry of Portland Cement. Reinhold Publishing Corp., 2nd ed., 793 pp.
- Chan, P. C., et al. 1978. Sorbents for Fluoride, Metal Finishing, and Petroleum Sludge Leachate Contaminant Control. EPA-600/2-78-024, U.S. Environmental Protection Agency, Cincinnati, Ohio. 94 pp.
- Chemical Manufacturers Association. 1982. A Hazardous Waste Management Plan. Chemical Manufacturers Assoc., Washington, D.C., Loose-leaf.
- Columbo, P., and R. M. Neilson. 1978. Properties of Wastes and Waste Containers. Progress Report No. 7. BNL-NUREG 50837, Brookhaven National Laboratory, Upton, New York.
- Cote, P. L., and D. P. Hamilton. 1983. Leachability Comparison of Four Hazardous Waste Solidification Processes. Presented at the 38th Annual Purdue Industrial Waste Conference, LaFayette, Indiana, May 10, 11, 12, 1983. 17 pp.
- DeRenzo, D. J. (ed). 1978. Unit Operations for Treatment of Hazardous Wastes. Noyes Data Corp., Park Ridge, New Jersey.
- Doyle, R. D. 1979. Use of an Extruder/Evaporator to Stabilize and Solidify Hazardous Wastes. In: Pojasek, R. B (ed.), Toxic and Hazardous Waste Disposal, Vol. 1, Ann Arbor Science Publishers, Ann Arbor, Michigan. pp. 65-91.
- Falcone, J. S., Jr., R. W. Spencer, and R. H. Reifsnnyder. 1983. Chemical Interactions of Soluble Silicates in the Management of Hazardous Wastes. Draft Report. The PQ Corp., Lafayette Hill, Pennsylvania.
- Grim, R. E., and N. Guven. 1978. Bentonites. Elsevier Scientific Publishing Co., New York. 256 pp.
- Hatayma, H. K., et al. 1981. Hazardous Waste Compatibility Protocol. California Department of Health Services, Berkeley, Calif., Rept. on Grant R804692010, U. S. Environmental Protection Agency, Cincinnati, Ohio.
- Haynes, B. W., and G. W. Kramer. 1982. Characterization of U. S. Cement Kiln Dust. Bureau of Mines Information Circ. 885, U. S. Dept. of Interior, Washington, D.C. 19 pp.

- Iadevaia, Rosa, and J. F. Kitchens. 1980. Engineering and Development Support of General Decon Technology and the DARCOM Installation Restoration Program. Task 4. Draft Rept. Atlantic Research Corp. Alexandria, Virginia. 77 pp.
- Lubowitz, H. R., and C. C. Wiles. 1978. Encapsulation Technique for Control of Hazardous Materials. In: Land Disposal of Hazardous Waste, Proceedings of 4th Annual Research Symposium, EPA-600/9-78-016, U. S. Environmental Protection Agency, Cincinnati, Ohio. pp. 342-356.
- Lubowitz, H. R., and C. C. Wiles. 1979. Encapsulation Technique for Control of Hazardous Wastes. In: Pojasek, R. B. (ed.), Toxic and Hazardous Waste Disposal, Vol. 1, Ann Arbor Science Publishers, Inc., Ann Arbor, Michigan. pp. 198-232.
- Malone, P. G., and L. W. Jones. 1979. Survey of Solidification/Stabilization Technology for Hazardous Industrial Wastes. EPA-600/2-79-056, U. S. Environmental Protection Agency, Cincinnati, Ohio. 41 pp.
- Malone, P. G., L. W. Jones, and J. P. Burkes. 1983. Application of Solidification/Stabilization Technology to Electroplating Wastes. In: Land Disposal of Hazardous Waste, Proceedings of the 9th Annual Research Symposium, U. S. Environmental Protection Agency, Cincinnati, Ohio. pp. 247-261.
- Malone, P. G., L. W. Jones, and R. J. Larson. 1980. Guide to the Disposal of Chemically Stabilized and Solidified Waste. SW-872, Office of Water and Waste Management, U. S. Environmental Protection Agency, Washington, D.C. 126 pp.
- Morgan, D. S., J. I. Novoa, and A. H. Halff. 1982. Solidification of Oil Sludge Surface Impoundments with Cement Kiln Dust (Draft Report). Albert Halff Associates, Inc., Dallas, Texas.
- Nemerow, N. L. 1971. Liquid Waste of Industry: Theories, Practices, and Treatment. Addison-Wesley, Reading, Massachusetts. 584 pp.
- Phillips, J. W. 1981. Applying Techniques for Solidification and Transportation of Radioactive Waste to Hazardous Waste. In: Proceedings of National Conference on Management of Uncontrolled Hazardous Waste Sites, Hazardous Materials Control Research Institute, Silver Spring, Maryland. pp. 206-211.
- Pillie, R. J., et al. 1975. Methods to Treat, Control and Monitor Spilled Hazardous Materials. EPA-670/2-75-042, U. S. Environmental Protection Agency, Cincinnati, Ohio. 148 pp.
- Ramachandran, V. S. 1976. Calcium Chloride in Concrete. Applied Science Publ. Ltd., London. 216 pp.

Rosencrance, A. B., and R. K. Kulkarni. 1979. Fixation of Tobyhanna Army Depot Electroplating Waste Samples by Asphalt Encapsulation Process. Technical Rept. 7902, U. S. Army Medical Research and Development Command, Ft. Detrick, Maryland. 23 pp.

Sheih, M. S. 1979. The Use of Natural Sorbents for the Treatment of Industrial Sludge Leachate. Ph.D. Dissertation, New Jersey Inst. of Tech., Newark, New Jersey. 144 pp.

Stanczyk, T. F., B. C. Senefelder, and J. H. Clarke. 1982. Solidification/Stabilization Process Appropriate to Hazardous Chemicals and Waste Spills. In: 1982 Hazardous Materials Spills Conference, Government Institutes Inc., Rockville, Maryland. pp. 79-84.

U.S. EPA. 1985. Handbook for Remedial Action at Waste Disposal Sites (Revised). EPA-625/6-85-006, U.S. Environmental Protection Agency, Cincinnati, Ohio. 497 pp.

U.S. EPA. 1984. Case Studies 1-23: Remedial Response at Hazardous Waste Sites. EPA-540/2-84-002b, Office of Emergency and Remedial Response, U. S. Environmental Protection Agency, Washington, D.C. 637 pp.

SECTION 3

PHYSICAL AND CHEMICAL CHARACTERIZATION OF UNTREATED WASTES

3.1 Physical Characterization

The physical characteristics of a waste material are important in determining the handling requirements for a waste. The equipment and methods for moving, storing, and mixing the waste will be determined by the range of physical characteristics involved. In many cases initial testing will result in a decision to introduce a preliminary dewatering or sorption step to provide a more easily handled solid with uniform physical characteristics. Physical characteristics that would be determined include:

- a. Percent moisture (water content)
- b. Suspended solids
- c. Bulk density
- d. Grain-size distribution
- e. Atterberg limits
- f. Cone index or California bearing ratio
- g. Unconfined compressive strength

Obviously some of these characteristics may not be useful because of the conditions of a particular material. If the waste is impounded, the testing program should be designed to consider the condition of the waste after re-suspension or partial dewatering or addition of an adsorbent. A detailed discussion of a range of physical testing procedures applicable to solidification and stabilization of hazardous materials is presented in Bartos and Palermo (1977).

3.1.1 Percent Moisture or Water Content

Water content is defined as the ratio of the weight of water to the weight of solids and is expressed as a percentage. The percent moisture or water content is used to develop requirements for pretreatment (settling, flocculating, filtering, and absorbing) and for designing solidification

procedures for the treated materials. Procedures for determining water content are given in Appendix I of U.S. Army (1972) and ASTM D2216-71 (ASTM 1973).

3.1.2 Suspended Solids

The amount of suspended solids is used to determine the materials handling requirements for the waste--that is, to determine if the waste can be pumped or whether another conveying system should be used. The suspended solids can also be used to predict volume decrease due to settling (primary consolidation) or water removal. Table 3-1 gives a typical classification system for the consistencies of slurried materials based on handling and processing requirements (Wyss et al. 1980).

TABLE 3-1. HAZARDOUS WASTE CONSISTENCY CLASSIFICATION

Consistency category	Characteristics
Liquid waste	<1% suspended solids,* pumpable liquid, generally too dilute for sludge dewatering operation.
Pumpable waste	<10% suspended solids,* pumpable liquid, generally suitable for sludge dewatering.
Flowable waste	>10% suspended solids,* not pumpable, will flow or release free liquid, will not support heavy equipment, may support high flotation equipment, will undergo extensive primary consolidation.
Nonflowable waste	Solid characteristics, will not flow or release free liquids, will support heavy equipment, may be 100% saturated, may undergo primary and secondary consolidation.

* Suspended solids ranges are approximate.

From Wyss et al. (1980).

Suspended solids (or settleable matter) can be determined using Method 224F(a) as given in APHA (1971). This method is equivalent to EPA Standard Method for Settleable Matter (Storet No. 5008G) as given in U.S. EPA (1979). Settleable matter is usually given in milliliters per liter volume of waste suspension.

3.1.3 Bulk Density

The bulk density, or bulk unit weight, is the ratio of the total weight (solids and water) to the total volume. These basic data are needed to convert weight to volume in materials handling calculations. Procedures for determining bulk unit weight are given in Appendix II of U.S. Army (1972).

3.1.4 Grain-Size Distribution

The grain-size distribution of an industrial waste becomes important in designing remedial actions. Fine-grained wastes generally present more handling problems and are subject to wind dispersion. Fine-grained wastes also present problems in producing high-strength solidified waste. Large percentages of fines lower the ultimate strength developed in concrete/waste composites.

Grain-size analyses are performed using methods described in Appendix V of U.S. Army (1972) or ASTM D422-63 (ASTM 1973). Preparation of samples for grain-size analysis usually follows specifications given in ASTM D421-58 (ASTM 1973).

3.1.5 Atterberg Limits

The Atterberg limits test determines the water contents of the material at the boundaries between its plastic and liquid states. The plastic limit is the water content at which the waste will start to crumble when rolled into a 3-mm thread under the palm of the hand. The liquid limit is defined as the lowest water content at which the sludge will flow as a viscous liquid. The Atterberg limits are used in classifying fine-grained materials to estimate their properties such as compressibility, strength, and swelling characteristics; these provide an indication of how the material will react when stressed.

A full discussion of the test and the equipment involved is given in Appendices III and IIIA of U.S. Army (1972) and ASTM tests D424-59 and D423-66 (ASTM 1973).

3.1.6 Cone Index

These tests involve forcing a standard cone into a sample of soil or other granular material and determining the resistance offered by the medium being tested. These tests are typically used to examine the ability of a subgrade soil to support a load (trafficability), but they are equally valuable in examining the strength of in-place wastes. Details on the test

procedures and interpretation are given in Sowers and Sowers (1970) and U.S. Army (1972).

3.1.7 Unconfined Compressive Strength

Unconfined compressive strength can only be measured on samples of cohesive or cemented waste. This type of test involves preparing a cylindrical specimen and loading it axially to failure. The test load is applied at a fixed rate of strain and compressive stresses are recorded as loading progresses. Unconfined compressive strength tests are used to determine bearing capacity and shear strength of cohesive materials. Shear strength is an important factor in determining the ultimate bearing capacity of the material, embankment stabilities, and pressures on retaining walls holding the material in place.

The standard test procedure is given in Appendix XI of U.S. Army (1972) and ASTM Standard Method D2166-66 (ASTM 1973). This type of testing requires that an average value be determined from a series of multiple samples.

3.2 Chemical Characterization

The requirements for chemically characterizing wastes present at remedial action sites vary widely depending on preliminary information on the types of waste involved. Any program of chemical analyses and testing should be designed to discover the following:

- a. The degree of hazard involved in handling and treating the wastes. These data are used to develop requirements for protective clothing and adaptations required for mixing and transporting equipment.
- b. The presence of interfering materials that can complicate stabilization/solidification. These data are used to develop pretreatment alternatives.
- c. The compatibility of wastes that would permit the mixing and consolidation of wastes for pretreatment and stabilization/solidification. This type of testing allows more economical operation and continuous processing of bulked wastes.

Testing programs oriented toward defining the degree of hazard involved in a waste material are outlined in U.S. EPA (1980). This type of testing concentrates on quantification of potential toxicants and screening for priority pollutants. Any program designed to evaluate the containment developed during stabilization/solidification must be based on consideration of the bulk composition of the waste. Leach testing of the treated waste will generally concentrate on the most potentially dangerous or soluble compounds discovered in the waste.

Chemical compounds that can present problems during stabilization/solidification may be relatively common, nontoxic materials. Oil and grease may interfere with pozzolan-Portland cement based processes. High concentrations of sulfate can cause swelling and spalling of pozzolan-Portland cement solidified wastes. High sulfate concentrations can be reduced by lime addition. The testing and analysis program will vary with the solidification process or processes being considered for use. Table 2-7 lists some of the constituents that can affect the performance of different stabilized/solidified waste materials and pretreatment options available to alleviate the problem.

Testing procedures for consolidating hazardous wastes have been developed to assist in segregating chemically compatible waste for storage and transportation. These same protocols can be adapted for screening hazardous waste for pretreatment and stabilization/solidification. A general system designed for consolidating drummed waste is given in Chemical Manufacturers Association (1982). A more general compatibility testing procedure and a waste compatibility matrix are available in Hatayma et al. (1981).

REFERENCES

- American Public Health Association (APHA). 1971. Standard Methods for the Examination of Water and Wastewater. Amer. Public Health Assoc., New York, New York. 874 pp.
- American Society of Testing and Materials (ASTM). 1973. Annual Book of ASTM Standards, Part II, Philadelphia, Pennsylvania.
- Bartos, M. J., Jr., and M. R. Palermo. 1977. Physical and Engineering Properties of Hazardous Industrial Wastes and Sludges. EPA-600/ 2-77-139, U.S. Environmental Protection Agency, Cincinnati, Ohio. 89 pp.
- Chemical Manufacturers Association. 1982. A Hazardous Waste Management Plan. Chemical Manufacturers Assoc., Washington, D.C., Loose-leaf.
- Hatayma, H. K., et al. 1981. Hazardous Waste Compatibility Protocol. California Department of Health Services, Berkeley, Calif., Rept. on Grant R804692010, U.S. Environmental Protection Agency, Cincinnati, Ohio.
- Sowers, C. B., and G. F. Sowers. 1970. Introductory Soil Mechanics and Foundations. 3rd ed., The Macmillan Co., London.
- U.S. Army, Office, Chief of Engineers. 1972. Laboratory Soils Testing, Engineer Manual 1110-2-1906, U.S. Army Corps of Engineers, Washington, D.C.
- U.S. EPA. 1979. Manual of Methods For Chemical Analysis of Water and Wastes. EPA-600/4-79-020, U.S. Environmental Protection Agency, Cincinnati, Ohio. 298 pp.
- U.S. EPA. 1980. Test Methods for Evaluating Solid Waste. SW-846, U.S. Environmental Protection Agency, Washington, D.C. Unpaginated.
- Wyss, A. W., et al. 1980. Closure of Hazardous Waste Surface Impoundments. SW-873, Office of Water and Waste Management, U.S. Environmental Protection Agency, Cincinnati, Ohio. 92 pp.

SECTION 4

SELECTION OF STABILIZATION/SOLIDIFICATION PROCESSES

4.1 Background

In undertaking any remedial action involving stabilization/solidification at an uncontrolled waste site, a number of problem areas have to be addressed. These include:

- a. Characteristics of the present waste disposal site. The geologic and hydrologic setting of the site determines to a great degree the feasibility of leaving the treated waste material on the site. An action could involve closing a site in place or constructing a new facility to contain the solidified waste onsite. Stabilization and solidification always increases the volume and mass of material to be disposed; therefore, solidification and transportation offsite is generally a more expensive option than shipping untreated wastes to a hazardous waste landfill.
- b. Character and volume of the waste to be stabilized or solidified. Wastes that are hazardous due to flammability, corrosivity, reactivity, infectiousness, or other properties that would normally exclude secure land burial usually cannot be solidified and disposed of by landfilling without adequate pretreatment. Wastes which are hazardous due to toxicity as defined by the Extraction Procedure (EP) testing benefit by stabilization and solidification in that it can decrease the concentration of toxic material in the EP leachate. Wastes that present specific problems (such as escape of volatile organics) may not be effectively contained using any economical stabilization/solidification technique although new sorbents are being developed to overcome these difficulties. Mixed wastes that require several pretreatment steps to produce solidification can become too expensive to process when costs are compared with those for transportation and secure land burial in a RCRA-permitted site. Small volumes of waste are often not economical to solidify or stabilize. At some sites where the wastes can be most easily handled by transportation and burial in a secure landfill, the least contaminated residual materials, such as sludges and contaminated soils, can be stabilized/solidified and landfilled in place. In every case, a cost comparison is a prime concern in examining stabilization/solidification options.

- c. Degree of hazard involved in handling the waste. The safety requirement for handling wastes in some circumstances is so great that stabilization/solidification for onsite disposal must be passed over to reduce long-term exposure to site personnel and inhabitants in a local area. Again, in such cases, marginally contaminated, high volume materials (soils or absorbents) may be the only material solidified and left onsite, although the bulk of the waste may be fixed to make its handling or its ultimate disposal safer and more economical.
- d. Possible site modifications to provide for ultimate disposal. Where the waste site in an unmodified condition would be unacceptable due to an undesirable geologic or hydrologic setting, engineering modification such as liners and drainage control may overcome site problems. Waste solidification can provide part of the required containment, and site modifications can complete the safe containment program.

A definition of how stabilization/solidification is to be employed at a specific remedial action site should result from these considerations. For instance, the wastes may be solidified and ultimate disposal involve burial onsite, or contaminated soils or absorbers may be solidified and buried onsite, while the waste themselves are transported. If solidification systems alone do not provide a high enough degree of protection, it may be necessary to modify the site to provide improved waste isolation.

Once decisions have been made on the role of solidification and the types and quantities of material to be solidified, it is possible to develop specifications for the stabilized/solidified waste. The nature of the waste and the containment properties required of the stabilized/solidified material determine the type of processing that can be used.

4.2 Specifications for Stabilized/Solidified Wastes

Specifications for stabilized/solidified wastes can include these characteristics:

- a. Leachability of waste components to contacting water.
- b. Free liquid content of waste.
- c. Physical stability of waste under burial conditions.
- d. Reactivity of waste.
- e. Ignitability or pyrophoricity.
- f. Susceptibility to biodegradation.
- g. Strength or bearing capacity of the waste.

- h. Permeability of the waste.
- i. Durability of the waste under conditions of surface exposure (freeze-thaw and wet-dry testing).

No standards for testing of stabilized/solidified waste have been developed. The specification and testing procedures outlined in this section are a minimum suggested testing program, and the specifications indicated are desirable but not mandated.

4.2.1 Leachability

A wide variety of extraction or leaching tests have been proposed for hazardous waste. None have been totally satisfactory for all types of stabilized/solidified wastes (Lowenbach 1978). Three major types of test procedures are usually involved in any evaluation procedure: Testing for regulatory purposes, testing for maximum hazard assessment, and testing for design of landfill facilities.

The regulatory testing procedures involve mixing the waste with some specified amount of extracting fluid (usually dilute acid or distilled water) and analyzing the resulting extractant for a required number of potential contaminants. Regulations may require that the waste be tested as a monolith or broken in a specific procedure such as the EPA Structural Integrity Procedure (Federal Register 1980, page 33128). The sample may or may not have to be sieved prior to testing. A set of criteria usually based on multiples of concentrations specified in the Primary or Secondary Drinking Water Standards are provided. Regulatory tests vary widely but the most accepted is the EPA Extraction Procedure or EP Toxicity Test Procedure (40 CFR 261.24, Appendix II, Federal Register 1980, page 33127). The maximum concentration of contaminants allowable in the EP leachate is 100 times the National Interim Primary Drinking Water Standard. Leachates containing greater than this level cause the waste to be defined as hazardous and be subject to all regulatory provisions; leachates with lower levels of all listed contaminants cause the waste to be classified as nonhazardous and thus not covered by these regulations.

Any test developed to assess the maximum hazard posed by a waste that is landfilled must be a generally flexible procedure that can handle a wide variety of wastes with a broad range of contaminant concentrations. This type of test assesses the maximum concentration of contaminants that can be developed in water contacting the wastes to be disposed. Procedures can be varied with the type of waste being tested. The waste is ground to a fine powder to ensure that a maximum surface area is presented to the contacting liquid. The ratio of waste to leaching medium is varied in such a way as to achieve a solution saturated with respect to compounds in the waste. Thus, the leach liquid may be separated from the waste and added to fresh wastes until the concentration of contaminants in the leachate no longer increases.

If the composition of the waste indicates that common ion effects are preventing some potential contaminants from appearing in equilibrium concentrations as they would if the waste contained only the pure contaminant compound, the waste can be leached with successive volumes of fresh leaching medium until a maximum concentration for the contaminant of interest is found. This type of test has no fixed level for rejection of the waste as hazardous, but concentrations of potential contaminants that go above the levels considered harmful to human health and the environment are noted. One example of this type of protocol is the Maximum Possible Concentration (MPC) Test outlined in Malone et al. (1980).

Leaching tests developed for engineering purposes attempt to develop leachate that duplicates that obtained from the landfilled wastes. This type of test is used to provide a basis for designing leachate treatment systems for proposed landfills and in evaluating the performance of treated (solidified) wastes developed for landfill disposal.

Several engineering tests have been proposed. The Solid Waste Leaching Procedure (SWLP) tumbles ground or monolithic waste samples in ten volumes of water per unit weight of sample (Garrett et al. 1981). A minimum of four successive extractions are performed to determine the changing character of the leachate.

Another proposed test for solidified industrial wastes is the Uniform Leaching Procedure (ULP) outlined in Malone et al. (1980) and discussed in detail in American Nuclear Society (1981), Cote and Isabel (1983), and Cote and Hamilton (1983). The ULP is a static leaching test that assumes that diffusion from the surface of a solidified waste is the major mechanism for contaminant transfer to surrounding water. A specific volume of waste is exposed to a fixed volume of water (or other leaching medium) that is changed on a regular schedule. If the surface area of the emplaced waste is known, estimates of the loss of contaminants from diffusion can be developed. Concentrations of contaminants in leachate can be used to postulate the environmental impact of the emplaced wastes.

The ULP and other static leaching tests for industrial wastes have been criticized because of the low reproducibility (only one order of magnitude in a leachability index) and the low levels of contaminants that must be quantified in the leachate (Cote and Isabel 1983). These problems can be overcome by concentrating contaminant from the leachate or by using tracer or surrogate compounds that can be added to the waste in appreciable quantities. Surrogate compounds can be selected that mimic the behavior of the toxic components in the waste and are easily determined at low concentrations; however, these newer methods of increasing the reliability of leaching tests have not been widely used or accepted.

Current guidelines for solidified low-level nuclear waste state that waste developed for land burial must have a leachability index greater than eight when measured using the standard static leaching test proposed by the American Nuclear Society (Nuclear Regulatory Commission 1983). Pozzolan-based and pozzolan-Portland-cement-based solidified industrial wastes prepared from dewatered industrial-type sludge all had leachability indices of

ten and above for arsenic, cadmium, chromium, and lead (Cote and Hamilton 1983). Industrial waste can be prepared to meet the Nuclear Regulatory Commission criteria if the waste is properly pretreated to eliminate highly leachable constituents and solidified using carefully developed procedures.

Any procedures for evaluating the leachability of stabilized/solidified waste should include all three types of testing: regulatory, risk assessment, and engineering design tests. The data developed in each type of test are useful for specific purposes such as delisting the waste as nonhazardous and determining the degree of containment needed in the disposal site.

4.2.2 Free Liquid Content

Free liquids in solid wastes are defined as liquids which readily separate from the solid portion of a waste under ambient temperature and pressure. Current regulations prohibit disposal of solid waste containing free liquids in landfills without pretreatment (i.e. mixing with an absorbent material) or treatment by in-situ absorption in the landfill.

A number of tests for free liquid have been proposed or can be adapted from other testing operations. Many test protocols, such as the inclined plane test or a simple gravity drainage test, do not take into account the pressure of overburden on the waste at the bottom of a landfill. A review of the test procedures is given in SMC-Martin (1981). Most solidified wastes are designed to be landfilled to an appreciable depth (10 to 20 m) of material. Therefore, any test for free liquid should take into account the increased pressure due to the overburden. To simulate overburden, a sample of material can be subjected to pressure while it is in an apparatus that will permit any exuded liquid to be collected. SMC-Martin (1981) outlines large and small pressure cells developed to measure free liquid production in moist refuse produced by overburden pressure.

A very simple approach is to place a solidified waste sample of specific size and weight between weighed clean filter pads and load the block of waste to pressures comparable to those developed in landfilling (10-m depth = about 200 kPa, or 30 psi). The exuded liquid is collected on the filter pads and the weight difference of the pads before and after pressure is applied is used to quantify the amount of exudate.

Current EPA regulations indicate that no free water should be present in the waste. The Nuclear Regulatory Commission (1983) has specified that solidified low-level radioactive wastes must be free-standing monoliths and that no more than 0.5 percent of the waste volume can be free liquid.

4.2.3 Reactivity and Ignitability

Stabilized/solidified wastes that are to be disposed of in a landfill (onsite or offsite) should meet the criteria for landfilled hazardous waste

in that due care must be exercised if the treated wastes are ignitable or reactive (40 CFR 265.312, Federal Register 1980). In most circumstances where stabilization and solidification are used, the waste can be rendered nonreactive or nonignitable in treatment. Tests for ignitability and pyrophoricity are given in Malone et al. (1980). Solidified/stabilized wastes developed for radioactive waste burial must not only be nonignitable, they must also be nonpyrophoric (i.e, will not support combustion if ignited) and must be nonreactive and nonexplosive (Nuclear Regulatory Commission 1983). Similar specifications for solidified industrial waste are desirable.

4.2.3.1 Reactivity.

Solidified wastes can contain reactive compounds that remain reactive after treatment. The wastes should be tested for compatibility with materials (absorbents, liners, other wastes) they would contact during landfilling. Procedures discussed in Hatayama et al. (1981) are useful for this purpose. Where possible, reactive materials should be destroyed or neutralized before stabilization.

If the potential for explosive reactions in waste exists, the Explosive Temperature Test (40 CFR 250.13) can be used to verify the hazard. Bureau of Explosives impact testing (49 CFR 173.53 (b), (c), (d) and (f)) can also be employed with solidified waste. Explosive and reactive wastes are not acceptable for landfilling.

4.2.3.2 Ignitability.

Solidified waste should not cause fires through friction, absorption of moisture, or spontaneous chemical changes. If ignited the material should not burn persistently (it should be self-extinguishing) or vigorously. Many biodegradable wastes produce methane under anaerobic conditions.

Many solidification systems which use cement and pozzolanic materials are inherently nonignitable and safe. Encapsulation systems using organic materials such as asphalt or polyethylene may require ignitability testing. Any liquid associated with the solid should be subjected to the test procedure given in ASTM Standard D-93-79 or D-3278-78 (ASTM 1973). Materials having flash-points less than 60° C are unacceptable. Any gases evolved from the waste should be nonignitable and nontoxic as specified in 49 CFR 173.300. The solid waste itself should not be capable of sustained burning if ignited. Tests such as ASTM F501 can be used to evaluate this property (Malone et al. 1980).

4.2.4 Physical Stability

Physical stability of the waste under conditions of burial is necessary to ensure that the waste can support necessary construction equipment and that, over the long run, it does not consolidate and cause the landfill cover to collapse or fracture. Membrane covers can fail through shear if the underlying waste consolidates or shrinks unevenly. Consolidation and shrinkage are problems that occur most often in moist, organic-rich wastes.

The amount of settlement that can be tolerated depends on the type of cover on the landfill and any future use of the filled area. If a soil cover is used and no future construction occurs on the landfill, then extensive settlement may not disrupt drainage or impair performance. If the final cover includes a membrane cover, settlement should be limited to the lowest achievable value. Table 4-1 lists the suggested test procedures for determining characteristics that relate to settlement of stabilized waste residuals. Some of these characteristics such as particle-size distribution and compaction may not be measurable on strongly cemented wastes. Wyss et al. (1980) discuss typical testing programs for consolidation.

TABLE 4-1. RECOMMENDED TESTING PROCEDURES FOR PHYSICAL CHARACTERISTICS THAT RELATE TO WASTE SETTLEMENT

Test	Procedure
Particle-size distribution density	ASTM D422-63 or EM 1110-2-1906 Appendix II*
Compaction	ASTM D698-70†
Consolidation	ASTM D2435-70
Compressive strength	
Unconfined	ASTM D2166-66
Triaxial shear	ASTM D2850-70
Plate load	ASTM D1194-72
Permeability	ASTM 2434-68 or EM 1110-2-1906 Appendix III*

* U.S. Army (1972).

† ASTM (1973).

4.2.5 Biological Stability

Biological activity in stabilized/solidified wastes is usually not desirable. Many biological reactions, such as sulfide oxidation or decomposition of hydrocarbons, can produce acids that attack lime-based solidification processes and increase the potential for leaching from the wastes. Methane gas can also be produced in large quantities under anaerobic conditions. Tests such as ASTM G21 and ASTM G22 (ASTM 1973) can be used to directly determine the ability of the wastes to support biological activity. The Nuclear Regulatory Commission (1983) requires that nuclear waste solidified with cement-based processes support no biological growth. Bituminous materials are permitted if only one bacterial colony develops per sample, using a sample of the size specified in ASTM C39 or ASTM D621 (ASTM 1973).

Indirect measuring systems can also be used. In indirect systems samples of the waste are subjected to biological testing and then followed by strength testing so that any decrease in strength can be documented.

4.2.6 Strength or Bearing Capacity

The ability of the treated waste to support the cover material relates directly to the strength and bearing capacity of the waste. Most measurements made on waste have used standard procedures such as ASTM D2166-66 or ASTM C39, where a sample of brittle material is tested to failure. Where bituminous materials containing wastes are included in the test procedure, ASTM D621 Method A (Nuclear Regulatory Commission 1983) has been recommended.

The dutch cone test and plate load test have been suggested as supplementary systems of testing solidified wastes (Brown and Assoc. 1981). These tests yield less precision but are applicable in the field.

Unconfined compressive strengths measured on solidified wastes have ranged from 5.5 kPa (0.8 psi) to 3.1×10^4 kPa (4500 psi) (Bartos and Palermo 1977). The Nuclear Regulatory Commission (1983) guidelines call for a compressive strength of 103.5 N/sq cm (150 psi) for rigid materials. Bituminous materials must show less than 20 percent deformation at this pressure.

Where it is suspected that the increasing the water content of the waste causes the waste to lose strength, a program of testing unsaturated and saturated specimens can be undertaken. Where soluble cementing materials like CaSO_4 are being used, wet-dry cycling should be required to demonstrate that the solidified waste will not lose strength after placement.

4.2.7 Permeability

Solidified wastes normally require the use of a falling head permeability test conducted in a triaxial compression chamber with back pressure to ensure complete saturation (U.S. Army 1972). Permeabilities measured in solidified waste typically range from around 10^{-4} to 10^{-8} cm/sec. No standards related to permeability have been developed for solidified waste. Such low permeabilities indicate decreased mobility in the treated waste and a slower transfer of contaminants from the solid mass to leaching waters.

4.2.8 Durability

Most solidified wastes do not have high durability when subjected to standard freeze-thaw or wet-dry test procedures (Bartos and Palermo 1977). However, solidified wastes are generally buried and not subjected to varying conditions. An adequate cover usually can minimize temperature and moisture variations in the wastes. Durability testing becomes important where uncovering of the waste by erosion or human activity is likely or where long-term durability must be estimated.

Durability testing is usually done using soil-cement test protocols. These include ASTM D560-57 for freeze-thaw testing and D559-57 for wet-dry testing.

4.3 Example Specifications

To select or develop an optional solidification system, it is necessary to specify the performance required under the conditions of burial that are being considered. Table 4-2 is an example of a specification that might be developed for a solidified waste. Some features of the waste can only be specified as landfill design is evaluated. For example, the loading under which the free liquid test would be run would depend on the maximum depth or loading proposed in the landfill. The durability testing may be restricted to the expected number of cycles that might occur after waste placement and before cover placement.

TABLE 4-2. EXAMPLE SPECIFICATIONS FOR SOLIDIFIED WASTE FOR LAND BURIAL

Characteristic	Recommended Value
Leachability	For major toxic components leachability is greater than 6 using ANS 16.1. Must pass EP test.
Free liquid content	No liquid exuded under maximum loading proposed in landfill design.
Physical stability	Will not allow unacceptable settlement under landfill design conditions.
Reactivity of waste	Nonreactive.
Ignitability	Nonpyrophoric. Flash point below 60° C using ASTM D-93-79 or D3278-78.
Ability to support microbial growth	No microbial growth observed using ASTM G21 or G22.
Strength	Greater than 1000 kPa (150 psi) using ASTM 39 or ASTM D621.
Permeability	Less than 1×10^{-5} cm/sec when measured using upflow triaxial procedure.
Durability	As required by site design. Measured using ASTM D560-57 and ASTM D559-57.

REFERENCES

- American Nuclear Society. 1981. Measurement of the Leachability of Solidified Low-Level Radioactive Wastes. Draft of Standard ANS-16.1. 47 pp.
- American Society for Testing and Materials (ASTM). 1973. Annual Book of ASTM Standards, Part II. Philadelphia, Pennsylvania.
- Bartos, M. J., Jr., and M. R. Palermo. 1977. Physical and Engineering Properties of Hazardous Industrial Wastes and Sludges. EPA-600/2-77-139, U.S. Environmental Protection Agency, Cincinnati, Ohio. 89 pp.
- Cote, P. L., and D. Isabel. 1983. Application of a Static Leaching Test to Solidified Hazardous Wastes. Presented at ASTM International Symposium on Industrial and Hazardous Solid Wastes, Philadelphia, Pennsylvania, March 7-10, 1983.
- Cote, P. L., and D. P. Hamilton. 1983. Leachability Comparison of Four Hazardous Waste Solidification Processes. Presented at the 39th Annual Purdue Industrial Waste Conference, Lafayette, Indiana, May 10-21, 1983.
- Federal Register. 1980. Hazardous Waste and Consolidated Permit Regulations. Vol 45, No. 98, Book 2, pp. 33063-33285, May 19, 1980.
- Garrett, B. C., et al. 1981. Solid Waste Leaching Procedure Manual. Draft Report Contract 68-03-2970, U.S. Environmental Protection Agency, Cincinnati, Ohio. 53 pp.
- Hatayma, H. K., et al. 1981. Hazardous Waste Compatibility Protocol. California Department of Health Services, Berkeley, California, Report on Grant R804692010, U.S. Environmental Protection Agency, Cincinnati, Ohio.
- Lowenbach, W. 1978. Compilation and Evaluation of Leaching Test Methods. EPA-600/2-78-095, U.S. Environmental Protection Agency, Cincinnati, Ohio. 111 pp.
- Malone, P. G., L. W. Jones, and R. J. Larson. 1980. Guide to the Disposal of Chemically Stabilized and Solidified Wastes. SW- 872, Office of Water and Waste Management, U.S. Environmental Protection Agency, Washington, D.C. 126 pp.
- Nuclear Regulatory Commission. 1983. Branch Technical Position on Waste Form. Document 204.1.5/TCJ/1/5/83, Nuclear Regulatory Commission, Washington, D.C. 10 pp.
- SMC-Martin. 1981. Test Protocol for Free Liquid Content of Hazardous Waste. Phase I, Contract No. 68-01-3911, U.S. Environmental Protection Agency, Washington, D.C. 128 pp.

U.S. Army, Office of Engineers. 1972. Laboratory Soils Testing. Engineer Manual 1110-2-1906, U.S. Army Corps of Engineers, Washington, D.C.

Wyss, A. W., et al. 1980. Closure of Hazardous Waste Surface Impoundments. SW-873, Office of Water and Waste Management, U.S. Environmental Protection Agency, Washington, D.C. 92 pp.

SECTION 5

BENCH- AND PILOT-SCALE SCREENING OF SELECTED TREATMENT PROCESSES

After preliminary selection of a stabilization/solidification system, a pilot-scale or bench-scale study can be developed to obtain detailed information on factors such as:

- a. Safety problems in handling waste.
- b. Waste uniformity and mixing and pumping properties.
- c. Development of processing parameters and the level of processing control required.
- d. Volume increases associated with processing.

Safety problems on larger scale stabilization/solidification operations may involve fuming, heat development, and volatilization of organic materials. Allowance may have to be made to adapt equipment for vapor control or cooling of reaction areas. Rapid addition of a reactive solidification agent (such as unhydrated lime) can cause rapid volatilization of organic compounds having low boiling points, with the possibility of a flash fire occurring. A fire believed to be caused this way occurred when lime was added to a sludge pit at Utica, Michigan, in 1983.

Heat transfer characteristics may be very different as a treatment or reaction system is scaled up and dimensions increase. With lower heat losses, temperatures rise, reaction rates are accelerated, and the solidification processes can become self-promoting. This is a common problem in operating with any large exothermic reaction such as hydration of Portland cement or the solidification of some organic polymers. Standard test procedures for heat of hydration of cements can be used in bench- and pilot-scale evaluation to predict heat generation and calculate temperature increases. A typical bench-scale procedure would be ASTM C 186, Test for Heat of Hydration of Hydraulic Cements (U.S. Army 1949).

A larger pilot-scale test involving 0.22 m³ (8 cu ft) of cement or pozzolan is given in the Corps of Engineers Test of Temperature Rise in Concrete (CRD-C 38 in U.S. Army 1949). Adaptations of this test, such as fume collection and temperature monitoring, may be made to allow the effects of volatilization of organic compounds to be considered. The insulated block may have to be vented to simulate loss of low-boiling-point waste components.

When fumes from a solidifying waste are anticipated to be a problem, it is necessary to examine the headspace gases that develop in a closed container such as partially filled drums containing solidifying wastes. Standard organic vapor or gas monitoring equipment can be used to estimate the severity of the problem. Hatayama et al. (1981) outline the usual procedures that would be used to determine whether a potentially hazardous reaction will occur when solidification or stabilization reagents are added to a waste. Typical equipment includes organic vapor analyzers of the gas chromatograph or infra-red absorption types or detectors based on colorimetric systems. The objective of testing would be to determine the peak concentrations of irritating or toxic volatiles that might be produced with an addition of a given reagent. If the concentration of toxic volatiles obtained exceeds safety standards (after assuming a reasonable dilution for the site), then an enclosed or vent-controlled mixing and reaction system may be required.

Mixing and pumping problems can arise from variations in the pumpability of the waste onsite (c.f., Table 3-1). Mixing can become a problem if the solidifying waste changes viscosity rapidly during setting. If a specific mixing or pumping technique is to be used in the field, pilot testing can be used to evaluate the performance of mixers and pumps. Standard test CRD-C 55-78 outlines techniques to be used in evaluating concrete mixer performance (U.S. Army 1949).

Where the flowability or pumpability of a waste/solidifier mix is required, tests such as CRD-C 611-80 would be appropriate, or tests such as CRD-C 612-80, Test Method for Water Retentivity of Grout Mixtures, can be used to predict the amount of fluid separation to be expected from a waste/solidifier mix (U.S. Army 1949).

Processing parameters such as mix ratios, mix times, set times, and conditions of treated waste curing have to be examined in each specific waste solidification project. The detail of work involved approaches that used in designing concrete mixes. Much of the pilot testing can be patterned after concrete design procedures (U.S. Army 1949), but it is largely trial and error because of the wide variety of waste types and reagent properties. For instance, fly ash, which is a most common reagent, varies in sorption and pozzolanic activity depending upon the coal source and firing conditions in the furnace, and its age and moisture content. Wastes will also vary between batches and even between the top and bottom of a single drum.

All solidification or absorption procedures result in some increase in waste volume. The volume increase can be seriously underestimated if too few measurements of additive requirements are made or if the moisture content of the absorbent or additive is greater in field specimens than in laboratory materials. Pilot tests with large, typical samples of additives usually provide more reliable estimates of additive volumes than laboratory bench studies, especially if care is taken to characterize additives (bulk density, moisture content, reactivity, etc.).

There is no substitute for a pilot study to evaluate a solidification program and develop production techniques in large-scale solidification

projects. Pilot studies also provide large samples of material required for more accurate, realistic testing, and permit reconciliation of the complications with equipment and material handling. Pilot studies can also be used to train equipment operators on the characteristics of the waste and the solidified product. Although quite expensive and time-consuming, pilot studies can reduce the possibility of a major accident, reduce work stoppages, and increase product consistency and process reliability. Pilot studies pay for themselves many times over in large-scale projects.

REFERENCES

U.S. Army. 1949. Concrete Handbook. U.S. Army Engineer Waterways Experiment Station, Vicksburg, Mississippi, Loose-leaf revised quarterly.

Hatayma, H. K., et al. 1981. Hazardous Waste Compatibility Protocol. California Department of Health Services, Berkeley, California, Report on Grant R 804692010, U.S. Environmental Protection Agency, Cincinnati, Ohio.

SECTION 6

FULL-SCALE TREATMENT OPERATIONS

6.1 Project Planning

Planning for the application of stabilization/solidification technology at a particular remedial action site is divided into two distinct stages as described in Section 1 (see Figure 1-1). The first planning stage considers the specific treatment technology and reagents best suited to the particular waste, including factors such as waste physical and chemical characteristics, reagent cost and availability, and environmental desirability; this phase has been considered in detail in the first five sections of this handbook. The second phase, which is covered in this and succeeding sections, is concerned with the overall operational and engineering plans for the actual completion of the project at the specific site--i.e., the treatment scenario. Specific aspects of this stage concern the development of equipment requirements, construction sequencing, and cost estimation for the stabilization/solidification portion of the remedial action project.

The development and selection of the solidification/stabilization operations plan for a particular remedial action site are dependent on several factors such as the nature of the waste material, the quantity of the waste material, the location of the site, the physical characteristics of the site, and the solidification process to be utilized. When the solidification program is being developed, the primary goal is to create optimum efficiency which is constrained by both short- and long-term environmental and public health considerations.

This section identifies four alternative scenarios as applied to the solidification/stabilization of hazardous wastes at remedial action sites and examines their technical feasibility and comparative costs. The treatment here is primarily concerned with the evaluation of equipment and project sequencing rather than with process chemistry. For purposes of this section, it is presupposed that the waste solidification/stabilization process has been selected and optimized, and that the site is geographically and geologically suitable for onsite disposal. The additional cost of transport and offsite disposal of the final product may be incurred if onsite disposal is not possible, but this possibility should not affect the validity of these discussions.

Onsite solidification/stabilization programs can be classified according to the manner in which the reagents are added to and mixed with the materials being treated. Four onsite solidification/stabilization alternatives are

examined in this document: in-drum mixing, in-situ mixing, mobile plant mixing, and area mixing. Modifications to these basic operational techniques are identified and discussed where appropriate. The selection of an appropriate solidification/stabilization technique is based on an analysis of waste, reagent, and site-specific factors. As a result, only generalized criteria can be developed as applied to conditions expected at any given remedial action site.

In-drum mixing is best suited for application to highly toxic wastes that are present in relatively small quantities. This technique may also be applicable in cases where the waste is stored in drums of sufficient integrity to allow rehandling. In-drum mixing is typically the highest-cost alternative when compared with in-situ, mobile plant, and area mixing scenarios. Quality control also presents serious problems in small batch mixing operations; complete mixing is difficult to achieve, and variations in the waste between drums can cause variations in the characteristics of the final product.

In-situ mixing is primarily suitable for closure of liquid or slurry holding ponds. In-situ mixing is most applicable for the addition of large volumes of low reactivity, solid chemicals. The present state of technology limits application of in-situ mixing to the treatment of low solids content slurries or sludges. Where applicable, in-situ mixing is usually the lowest cost alternative. Quality control associated with in-situ mixing is limited with present technology.

Mobile mixing plants can be adapted for application to liquids, slurries, and solids. This technique is most suitable for application at sites with relatively large quantities of waste materials to be treated. It gives best results in terms of quality control. Mobile plant mixing is applicable at sites where the waste holding area is too large to permit effective in-situ mixing of the wastes or where the wastes must be moved to their final disposal area.

Area mixing consists of spreading the waste and treatment reagents in alternating layers at the final disposal site and mixing in place. This technique is applicable to those sites where high-solids-content slurries or where contaminated soils or solids must be treated. Area mixing requires that the waste materials be handled by construction equipment (i.e., dump-trucks, backhoes, etc.) and is not applicable to the treatment of liquids. Area mixing is land-area intensive, as it requires relatively large land areas to carry out the process. Area mixing presents the greatest possibility for fugitive dust, organic vapor, and odor generation. Area mixing ranks below in-drum and plant mixing in terms of quality control.

6.2 Cost Analysis and Comparison

The cost analyses in this chapter are by necessity general and based on generic techniques and equipment. They are included not as definitive numbers but as illustrations of the kinds of considerations which go into such

analyses. They also give a feel for the applicability of the different procedures which are discussed. We wish to emphasize that specific site and/or waste characteristics can change these estimates by severalfold.

To increase the usefulness of comparisons the cost calculations are based upon factors and assumptions which are consistent for the different alternatives. Further, they illustrate the relative proportion that each cost subcategory contributes to the overall cost of the process and then allow estimates of the effect of substitution of alternate reagents or equipment on the total process cost. The treatment reagents chosen for all alternatives, Portland cement and sodium silicate, are not universally applicable as might be implied by their inclusion in all alternatives; but they are used in all examples because they make the comparisons valid and because their cost is typically about average or slightly higher than other reagents. Discussion and comparisons with other treatment reagents are included in the summary (Section 6.7.2).

Labor costs shown in the illustrations are uniform throughout and include 25% fringe benefits. Reagents are priced at onsite costs as shown in Appendix A. All equipment is charged at a daily rate of 0.5% of market value which includes all fuel, interest, maintenance, and depreciation (3-year base); this rate is unrealistic in some cases, but it serves well for comparison purposes. The equipment rental rates thus calculated are in line with those quoted by industrial sources (see Appendix B).

6.3 In-Drum Mixing Alternative

The disposal of drums containing toxic and hazardous liquids and sludges in landfills or open outdoor storage areas has been a common practice in the United States. Many of the problems with uncontrolled disposal sites can, in part, be linked to inadequate drum disposal activities. Typically, these drums are 55 gallons (208 liters) in size although other sizes may also be encountered. In-drum solidification is an attempt to utilize onsite assets (i.e. drums) as both mixing vessel and container for the solidified waste materials.

Handling of the drums of materials onsite and offsite before and after solidification/stabilization is a major consideration in this alternative. Related problems of selection and implementation of equipment and methods for handling drums must be independently determined. Factors that influence the selection of drum handling equipment or methods include worker safety, site-specific variables, environmental protection, and costs. An EPA (1983) manual reviews the applicability, advantages and disadvantages of equipment, and methodologies for handling drums. The manual addresses detecting and locating drums, determining drum integrity, excavation and onsite transfer of drums, recontainerization and consolidation, and storage and shipping.

In-drum mixing can use existing or new drums. Where drum integrity allows, the reagents are added directly to the drum in which the waste has been previously stored. Drum reuse has the advantage that maximum use is

made of onsite assets, and drum crushing and disposal considerations are eliminated, with subsequent cost savings. However, in-drum mixing is often precluded because the poor condition of the drums or the need for head space in the drum does not allow for addition of the solidification/stabilization reagents and resulting expansion of the treated wastes. Typical head space requirements range between 50% and 30% of drum volume. Thus, if all drums have sufficient integrity for use, 0.5 to 1 additional drum is required for each drum of existing wastes.

Most drums found at abandoned waste sites have only a bung hole in a solid top. These drums pose a special problem because the opening is too small to insert bulk reagents or an adequate mixing apparatus. Testing of the composition of the contents or of their homogeneity is also difficult. The most common procedure used to overcome these problems is to redrum the contents in new or used, open-topped drums at which time the contents can be visually inspected for uniformity or phase separation. A second alternative is to cut a larger opening in the drum top for access. Although this procedure is cost-effective with drums which are in good condition, the added labor and equipment cost and exposure of employees lessens the benefits of the latter method. Care should be taken to use a nonsparking cutting apparatus (e.g., one of bronze), as the head space may contain explosive gas mixtures.

If new drums are required, the cost of the in-drum mixing option is substantially increased. Although the labor cost increases because of implied redrumming requirements, the primary increase in cost is that of the drums. The cost of drums (July 1983) ranged between \$10 and \$60 per drum depending on the supplier and transportation costs.

6.3.1 Project Sequencing

Project sequencing for in-drum solidification can be divided into seven steps:

- a. The contents of each drum to be treated must be evaluated and/or identified. Particular care must be taken to ensure compatibility with the proposed solidification/stabilization process and the wastes. Each drum should be marked with appropriate identifying information. Costs associated with this testing are not included in this analysis and can be substantial.
- b. The condition of each drum should also be evaluated. Drums that are in sufficiently good condition for reuse should be marked. Head space in each drum should be noted on the exterior of the drum, and materials should be redrummed as required to accommodate head space and drum condition requirements.
- c. A materials handling location should be prepared. Chemical storage and mixing equipment should be centrally located. A concrete pad or gravel surface should be prepared to ensure an adequate materials-handling facility for all weather conditions. Consideration should

be given to materials flow, including incoming empty drums, incoming drums containing waste materials, and outgoing product drums. For large sites, multiple materials handling locations may be cost-effective.

- d. Solidification/stabilization chemicals should be added to and mixed with the wastes being treated.
- e. The drums of mixed materials should be placed in a secure area and allowed to set or cure until stable enough for safe handling.
- f. After curing, any remaining head space should be filled with inert material and the top replaced.
- g. The drums should be removed for final disposal.

6.3.2 Equipment Requirements

Equipment requirements for the in-drum mixing process include: onsite chemical storage system, chemical batching system, mixing system, and drum handling system. Prior to actual solidification, a temporary enclosure for the equipment should be erected. The mixing equipment should be installed on a prepared surface that will facilitate the cleanup of spills and ensure ease of daily cleanup. Requirements for the mixing area depend on the size of the remedial action process and the nature of the wastes being treated. The enclosure serves to protect personnel from the elements and provides a controlled environment to minimize airborne hazards.

Mixing equipment for in-drum solidification includes the change-can mixer and the top-entering propeller. Figure 6-1 illustrates in-drum solidification using the top-entering propeller.

6.3.3 Costs

In-drum mixing has the highest per unit cost of the four solidification/stabilization techniques examined (Table 6-1). The total cost of cement-silicate solidification using the equipment, labor, and assumptions listed below is over \$50 per drum holding only 40 gal of waste. Since reagent costs are only a small part (about 12%) of the total cost per drum, using smaller amounts of cheaper reagent would not greatly affect the overall cost (see Section 6.7.1). Labor, equipment rental, and used drums each account for between 15% and 25% of the total cost, for a total of about 60% of the total (not including the 30% for profit and overhead). The high labor and equipment costs result from the very low throughput of the system--only 4.5 drums per hour, which is less than 1 cu yd. Increasing this throughput would produce an appreciable reduction in treatment costs since over half of the cost is sensitive to the production rate. The cost of treating 500,000 gal of waste using this system is about \$750,000--about \$1.50 per gallon. Economic

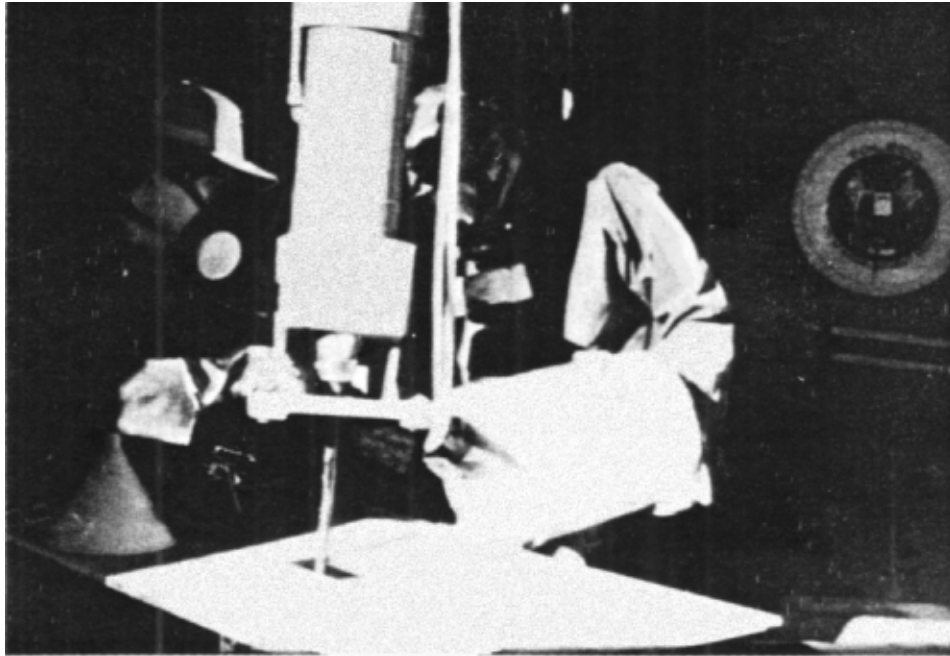

Figure 6-1. In-drum mixing using a top-entering propeller mixer.

considerations alone limit this treatment system to small amounts of very toxic wastes; it cannot compete with the dedrumming and bulk treatment of compatible wastes as done in other alternative techniques to be discussed. Even for wastes already contained in re-usable drums, the total cost would decrease only by about 20% to about \$207/ton (\$40.90/drum) in this example. Costs of initial classification, screening, and handling from remote site locations and to the point of final disposal and final disposal are not included.

The procedure for estimating the cost of in-drum solidification/stabilization is summarized in Table 6-1 and detailed as follows:

a. Assumptions.

- (1) Solidification/stabilization process selected using Type I Portland cement (30%) and sodium silicate (2%).
- (2) Specific weight of waste to be solidified/stabilized is 85 lb/cu ft.
- (3) Approximately 40 gal of untreated waste can be placed in a drum and leave enough head space for reagent addition.
- (4) Processing rate averages 4.5 drums per hour.

TABLE 6-1. COST ESTIMATES FOR THE IN-DRUM TREATMENT ALTERNATIVE

Note: Stabilization/solidification with 30% (w/w) Portland cement (Type I) and 2% sodium silicate of 40 gal of waste (85 lb/cu ft) in 55-gal drums at 4.5 drums per hour throughput.

TREATMENT REAGENTS:

30% Portland cement = 137 lb/drum × (\$0.0275/lb) = \$3.77/drum
 2% sodium silicate = 9 lb/drum × (\$0.10/lb) = \$0.90/drum
 Total cost for 12,500 drums: \$58,275 \$ 4.67/drum

LABOR COST FOR TREATMENT:

1 ea Project supervisor = \$27.50/hr = \$6.11/drum
 2 ea Laborers @ \$12.50 = 25.00/hr = 5.55/drum
 Total labor cost for 12,500 drums: \$145,750 \$11.66/drum

MATERIALS: Used, reconditioned drums: 12,500 for \$137,500 \$11.00/drum

EQUIPMENT RENTAL:

	Capacity	Value	Per hour	Per drum
Chemical storage silo	2,000 cu yd	\$20,000	\$13.15	\$2.92
Change-can mixer	5 cu yd	15,000	9.90	2.20
Forklift	1 ton	14,250	9.40	2.09
Chemical feed system	100 lb/min	8,700	5.70	1.27
Total rental for 12,500 drums: \$106,000				\$ 8.48/drum

MOBILIZATION-DEMOBILIZATION AND CLEANUP: 10% add-on = \$44,750 \$ 3.58/drum

TOTAL COST OF TREATMENT: 12,500 drums for \$492,275 \$39.36/drum

PROFIT AND OVERHEAD (@ 30% of cost): \$147,682 \$11.81/drum

TOTAL CONTRACTED PRICE PER DRUM: \$51.17/drum

TOTAL CONTRACTED PRICE FOR 12,500 DRUMS
 (500,000 gal or 2,850 tons of waste):

\$639,957 or \$224.29/ton

- (5) Onsite cost of reagents is approximately \$0.0275 per pound (\$55 per ton) for Portland cement and \$0.10 per pound (\$200 per ton) for sodium silicate.
- (6) Onsite labor dedicated to the solidification process includes two general laborers at \$12.50 per hour, and one project supervisor at \$27.50/hr.
- (7) Reconditioned drums costing \$11.00 each are used. Note that new drums can cost up to \$40.00 each.
- b. Chemical requirements per drum.
- (1) Portland cement at 30% by weight:
- $$\frac{(40 \text{ gal/drum}) * (85 \text{ lb/cu ft}) * (0.30)}{(7.48 \text{ gal/cu ft})} = 137 \text{ lb/drum}$$
- (2) Sodium silicate at 2% by weight:
- $$\frac{(40 \text{ gal/drum}) * (85 \text{ lb/cu ft}) * (0.02)}{(7.48 \text{ gal/cu ft})} = 9 \text{ lb/drum}$$
- c. Equipment rental and operation cost. Equipment rental and operation costs are computed for a 2,000-cu-yd chemical storage silo (\$20,000), a 5-cu-yd change-can mixer (\$15,000), a 1-ton forklift (\$14,250), and a 100-lb/min chemical feed system (\$8,700).
- d. Allowance for profit and overhead. Profit and overhead allowances for this type work (based on construction company rates) range between 20 and 40%. Since this is assumed to be a high-risk operation, assume 30% profit and overhead.
- e. Costs not included. Note that the above cost includes the solidification/stabilization process and handling immediately before and after mixing. The following costs, which may be substantial, are not included: Identification and evaluation of drum contents, evaluation of drums, transport of drums to treatment area and of solidified/stabilized material to the final disposal site, and site preparation and closure activities.
- f. Summary of in-drum mixing. As seen in Table 6-1, the estimated actual cost of stabilization/solidification including profit and overhead is around \$51 per drum (\$244/cu yd or \$258/ton). Of this, only about 10% is for the treatment reagents, while 30% goes for labor (including mobilization-demobilization), 21.5% for reconditioned drums, and about 16.5% for equipment. Since only about half of the cost of treatment is fixed per unit of waste (drums and reagents), the unit price is quite sensitive to production rate. Doubling the rate from 4.5 drums per hour to 9 drums per hour with the same equipment essentially lowers the unit treatment cost by

about 25% to around \$148/ton (\$29.32/drum) or total cost with profit and overhead to \$192.50/ton (\$38.11/drum). If original drums are usable, the total cost of treatment will drop another 25%.

6.3.4 Safety and Environment

In-drum solidification/stabilization can provide the safest and most environmentally controlled work environment. Equipment can be purchased and installed to meet all Occupational Safety and Health Administration (OSHA) standards. A variety of standard accessories including dust hoods, dust shields, and vacuum hoods are available for the change-can mixer (these items are not included in costs shown in Table 6-1). In addition, the equipment can be easily operated by personnel in protective clothing. Typical protective clothing will include rubber gloves, safety glasses, hard hat, and dust mask or respirators. Equipment operation can also be accomplished in full air pack. Note that if full air pack protective equipment is required, a 50% to 60% reduction in productive capacity can be anticipated.

6.3.5 Modifications

In-drum or in-container solidification has been used extensively in the disposal of low-level radioactive waste materials. Specialized in-drum mixing equipment has been developed for this application. Particular attention has been given to the safety-related aspects of such equipment. Special drum fill-heads and remote monitoring systems have been developed to allow the drum to be filled, the reagents to be added, the contents mixed, and the drum sealed by operators isolated from the waste. Because of the high cost of these systems, they have not been widely used for the treatment of toxic and hazardous waste materials. They may have applicability to the solidification/stabilization of extremely toxic or hazardous wastes.

Another product of the nuclear industry is the prepackaged spill solidification kits. These systems are designed for the cleanup of small spills and include the mixing drum, premeasured solidification reagents, and disposable mixing blades. Kits come in a variety of available sizes complete with instructions. The user must supply a driver for the mixing blades. Figure 6-2 illustrates a typical spill cleanup drum solidification system. A 1981 price quote for a 55-gal drum system (40-gal maximum waste volume) was \$600 per pallet of four drums f.o.b. plant of manufacture. These systems are considered for specialty purposes only and are not economically practicable for large-scale sites.

A final modification of the in-drum solidification scenario is the bulking of drummed liquids, solidification of the bulked liquids in a mobile or portable plant (Section 6.5), and repackaging of the solidified wastes in salvaged or new drums. This modification may be appropriate at sites with significant numbers of broken or leaking drums containing compatible wastes,

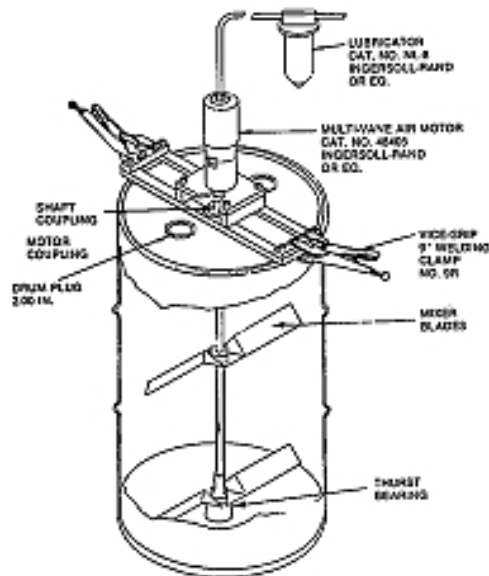

Figure 6-2. Typical spill cleanup system
(Courtesy Delaware Custom Materials).

or as a method to reduce the unit cost by increasing the production rate and simplifying the equipment required.

6.4 In-Situ Mixing Alternative

The simplest solidification/stabilization alternative examined in this study is in-situ mixing which incorporates the use of common construction machinery (typically a backhoe or pull-shovel) to accomplish the mixing process. Where large lagoons are being treated, clamshells and/or draglines have also been utilized. This technique is suitable for application to liquids or light flowable sludges having a high liquid content. The technique is suited more to those solidification/stabilization processes incorporating the addition of large amounts of bulk powdery solids (kiln dust, fly ash, etc.) to the waste materials. In those cases where small amounts of admixture (fluidizers, plasticizers, retardants, etc.) are to be added, the mixing efficiency of available in-situ processes is not uniform. Data are not currently available on the mixing efficiency of the in-situ processes when applied to large-scale field projects.

6.4.1 Project Sequencing

Two in-situ solidification/stabilization alternatives are developed. In the first, the existing lagoon is used as both the mixing vessel and the final site for disposal of the treated wastes so that the waste materials are not removed from the existing lagoon or holding pond. In the second, the waste material is removed from the holding pond and placed in specially prepared mixing pits. After mixing, the treated wastes are either removed from the mixing pits to a prepared disposal site or are left in the mixing pits which become the final disposal site.

Under the first alternative, the existing holding lagoons are used as the final disposal site. The reagents are added to the lagoon by pneumatic or mechanical means. Pneumatic addition uses blowers to distribute the reagents over the surface of the lagoon. Mechanical addition incorporates the use of dump trucks, front-end loaders, or clamshells to mechanically add the required reagents. Mixing of the reagents is accomplished with a backhoe, clamshell, or dragline. The selection of mixing equipment is based on the size of the lagoon being treated and general site topography. Lagoons less than about 30 ft (10 m) in radius (or effective radius in the case of rectangular or odd-shaped lagoons) are amenable to backhoe mixing. Larger lagoons would require the use of a clamshell or dragline to ensure an adequate reach for mixing the contents in the middle of the lagoon.

The second alternative involves the preparation of special, onsite mixing pits. The waste material is transferred from the holding lagoon to the mixing pit. Pumps can be used to transfer liquids and light sludges whereas clamshells and trucks can be used to transfer heavy sludges. Reagents are added using the same methods described in the first alternative. Since the mixing pit can be constructed to a specified size, mixing is generally accomplished with a backhoe. After thorough mixing, the material is allowed to gel, or set, for the required amount of time. The solidified/stabilized material is then either capped in place (in the mixing pit) or removed to a prepared onsite disposal facility.

6.4.2 Equipment Requirements

Equipment required for in-situ solidification/stabilization varies with the specific site. Generally, an average site would require equipment in the following categories: dump trucks, front-end loader, excavator or backhoe, and onsite chemical storage and handling facilities. The size and amount of equipment depend on the location and topography of the remedial action site as well as the quantity of material to be treated. Figure 6-3 illustrates in-situ mixing using a backhoe.



Figure 6-3. In-situ mixing with a backhoe at a large site.
(Courtesy Albert H. Halff Associates)

6.4.3 Costs

The cost of in-situ solidification/stabilization techniques is based primarily on the production rate achieved by the equipment mix selected for the specific remedial action project. Field data for the cost of in-situ mixing alternatives applied to remedial action sites are not available. However, production rates were determined for two RCRA sites using the backhoe-mixing pit technique. A daily (8-hr shift) production rate ranging from 1,000 to 1,200 cu yd (approximate 1000 cu m) of wastes solidified/stabilized was reported under the following conditions:

- a. Construction of an earthen mixing basin (5 to 10 ft deep, 40 to 50 ft in diameter).
- b. Introduction of liquid wastes received in bulk tankers or from de-drumming of liquids received in drums.
- c. Addition of 40% to 60% (by volume) of fresh kiln dust, mechanically added with a front-end loader.
- d. Mixing with backhoe (Caterpillar 225) until solidification/stabilization process begins.

- e. Setting or gelling for 24 to 48 hr in the pit.
- f. Removal of solidified/stabilized material from pit with front-end loader or backhoe and spreading in secure landfill with dozer.

Another RCRA site using a similar scheme and equipment, except for the substitution of permanent concrete mixing pits (4 pits, 100 ft × 20 ft × 10 ft), reported daily (8-hr shift) production rates of 2,000 cu yd. This second RCRA site also had the capability of pneumatically adding bulk solid reagents.

The cost of solidification/stabilization at these RCRA sites was reported to range between \$10 and \$20 per cubic yard of waste material treated. The primary variable was the amount of kiln dust required for a specific waste. This factor affected chemical costs, material handling costs, and mixing labor costs.

The daily production rate for the backhoe mixing technique depends on the material being handled, size and quantity of equipment being used on a particular project, site conditions, quantity of material being treated, and quantity of reagent being added. Production rates for a remedial action site are expected to be somewhat less than those associated with a permanent installation. An in-situ treatment scheme incorporating one backhoe (Caterpillar 225 or equivalent) is anticipated to have a daily (8-hr shift) production rate ranging between 750 and 1,500 cu yd.

The procedure for estimating the cost of in-situ solidification/stabilization is presented below and summarized in Table 6-2:

a. Assumptions.

- (1) Approximately 500,000 gal of waste liquids and light sludges is to be solidified in situ using cement and sodium silicate. Mixing will be accomplished with a backhoe (Caterpillar 225 or equivalent). Wastes to be treated are contained in a rectangular-shaped lagoon approximately 120 ft × 60 ft × 10 ft.
- (2) Bench-scale studies indicate that the reagent must be added on a weight-to-weight ratio of 30% cement and 2% sodium silicate.
- (3) Waste and reagents will be mixed in the lagoon and left in place.
- (4) Onsite cost of cement is \$55.00 per ton; sodium silicate is \$200 per ton.
- (5) The remedial action site is located 200 miles from the nearest equipment.

TABLE 6-2. COST ESTIMATES FOR THE IN-SITU TREATMENT ALTERNATIVE

Note: Stabilization/solidification with 30% (w/w) Portland cement and 2% sodium silicate of a pumpable waste (85 lb/cu ft) from bulk tankers or drums mixed with a backhoe in an 8-ft-deep, 40-ft-diameter earthen mixing basin, and removed after 24 to 48 hr setting time. Total waste 500,000 gal (2,475 cu yd or 2,850 tons) and production rate is 800 cu yd per 8-hr shift (4 days required).

TREATMENT REAGENTS:

30% Portland cement	= 855 tons × (\$55/ton)	= \$47,025	
2% sodium silicate	= 57 tons × (\$200/ton)	= \$11,400	
Total cost of treatment reagents:		<u>\$58,425</u>	\$20.50/ton

LABOR COST FOR TREATMENT:

1 ea Project supervisor	= \$27.50/hr × 32 hr	= \$ 880	
2 ea Heavy equip. operators @ \$22.	= \$44.00/hr × 32 hr	= 1,408	
1 ea Laborer	= \$12.50/hr × 32 hr	= 400	
Total labor cost:		<u>= \$2,688</u>	\$ 0.94/ton
Expenses: @ \$75/day for 4 men 4 days		= \$1,200	\$ 0.42/ton

EQUIPMENT RENTAL:

	Capacity	Value	Per hour	Per 6 days	
Backhoe	(1.5 cu yd)	\$95,000	\$62/hr	= \$2,976	
Front-end loader	(1 cu yd)	29,000	\$20/hr	= 960	
Total rental cost:				<u>\$3,936</u>	\$ 1.38/ton

MOBILIZATION-DEMOBILIZATION AND CLEANUP:

Labor and expenses for 3 days:	\$2,016 + \$900	= \$2,916	
Transportation: 200 mile/trip × 4 trips × \$2/mile		= 1,600	
Total		<u>\$4,516</u>	\$ 1.58/ton
TOTAL COST OF TREATMENT: 500,000 gal	= \$70,765		\$24.83/ton
PROFIT AND OVERHEAD: (@ 30% of cost)	= \$21,230		\$ 7.45/ton
TOTAL CONTRACTED PRICE: 500,000 gal	= \$91,995		\$32.28/ton

- b. Mobilization and demobilization costs. Mobilization costs are those incurred in preparing the equipment for shipment, transporting it to the site, and setting it up for mixing. Demobilization includes cleanup of the equipment and site and transportation back to origin. Mobilization-demobilization will take about 1 day each. Transportation costs are those associated with actually transporting the equipment to the site. For this example, it is assumed that local equipment rental is not available. Two tractor trailer loads will be required. The estimated cost of heavy equipment transport is \$2.00 per load mile.
- c. Project duration.
- (1) Based on field experience, a daily production rate (8-hr shift) is estimated to be 700 cu yd/day of wastes mixed.
 - (2) Required project time is calculated as follows:
$$500,000 \text{ gal} \div 7.48 \text{ gal/cu ft} \div 27 \text{ cu ft/cu yd} \\ \div 700 \text{ cu yd/day} = 3.54 \text{ days (use 4 days).}$$
 - (3) Since processing will be accomplished at a remote site, personnel will be reimbursed for onsite expenses. Assume an expense rate of \$75.00 per man per day.
- d. Summary of in-situ costs. The in-situ treatment alternative is the fastest and least expensive of those discussed in this section. The speed and economy are largely due to the reduction in the amount of handling of the waste mass. Other than for mixing, the wastes are usually moved only once, or if not hazardous, they are often not even removed from the original waste lagoon but mixed and left in place. The method lends itself best to liquid or low-solids sludges which are easily mixed. However, heavy sludges can be mixed with heavy equipment like draglines or clamshells, but with less uniformity in the treated product. The low labor and equipment requirements result in the highest proportion of the cost (63%) going for the treatment reagent. Thus the cost of the method is quite sensitive to reagent cost and proportion. Major limitations of the method are the low amount of mixing attained and the inability to control accurately the proportion of reagent to waste which can result in a nonuniform, unevenly mixed final product. This can be overcome to some extent by using excess reagent to decrease zones of low reagent content, but this increases cost and treated product bulk.

Two new pieces of equipment which are designed and used specifically for in-situ mixing have recently been introduced; they are shown in Figures 6-4 and 6-5. These items pneumatically meter and inject the reagent directly into the waste mass at the lower end of the cylinders, which are used to stir and mix the wastes. One design (Figure 6-5) has augers at the ends of the

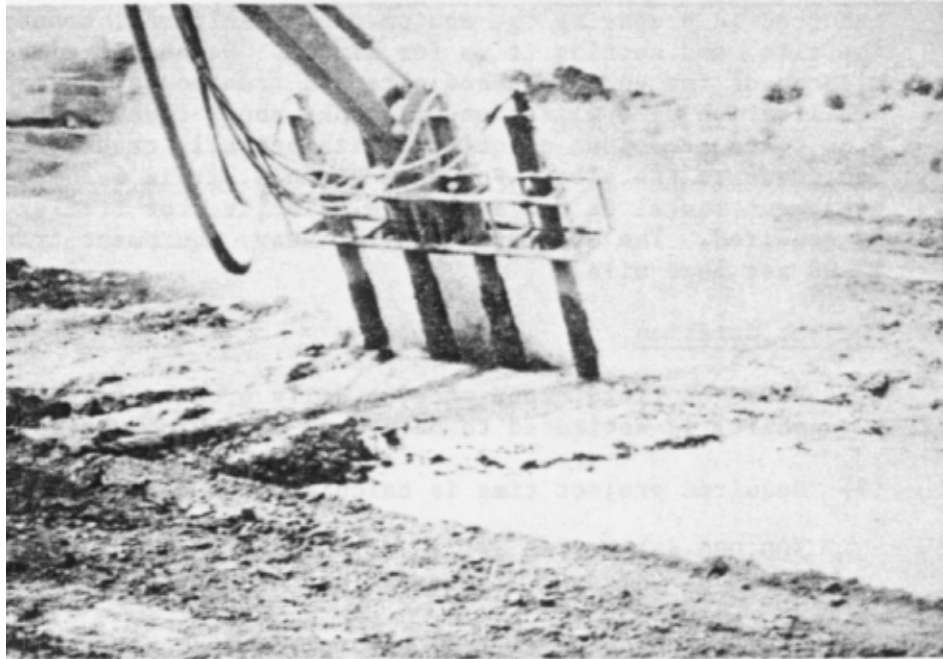

Figure 6-4. In-situ mixing by direct reagent injection
(Courtesy ENRECO, Inc.).

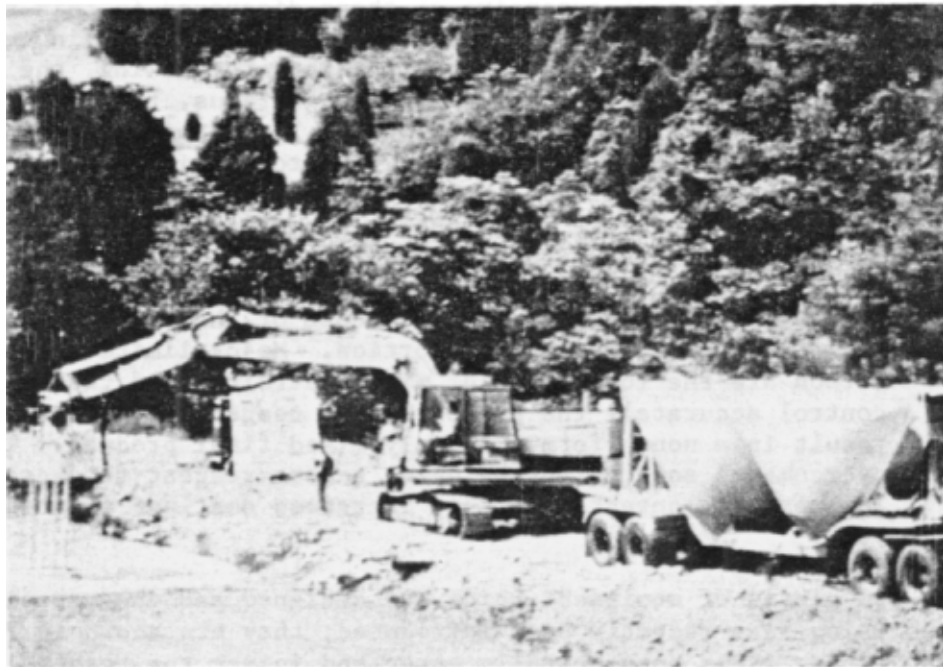

Figure 6-5. In-situ mixing equipment
(Courtesy American Resources Corporation).

cylinders which can be used to dig into underlying soils or sludges which may also be contaminated and incorporate them into the total waste mass.

6.4.4 Safety and Environment

In-situ mixing is the most difficult alternative in terms of control of safety and environmental considerations. Since the entire process is open to the atmosphere, anticipated problems include the generation of odors, vapors, and fugitive dust. In addition to the standard safety precautions associated with the operation of construction equipment, a strict program for minimizing exposure of personnel and equipment to the materials being treated should be implemented. Equipment should be decontaminated on a daily basis and the wash water should be collected for treatment or solidification.

Standard personnel protective procedures should be implemented as necessary, depending on the waste being handled. Reduction in production efficiency can be anticipated to be a function of the degree of protective apparatus required. Level A protection is expected to reduce production by up to 75 percent.

The ability to control adequately the in-situ mixing process is a subject of concern. Quantitative measurement of the degree of mixing produced by in-situ processes is not available. Most in-situ mixing operations are found at RCRA waste disposal sites where the mixed waste and solidification reagents are removed to a landfill after gelling. The rehandling of the processed materials allows some quality control of the adequacy of waste-reagent mixing. This additional level of quality of control may be lacking in the field environment unless the materials are rehandled and transported to a separate disposal area. Assurance of adequate quality control requires significant levels of experienced, onsite inspection and supervision.

6.4.5 Modifications

The chemical addition and mixing techniques currently used for in-situ solidification have been adopted from the construction industry and as such are relatively unsophisticated. Major modifications to in-situ solidification/stabilization include the development of reagent addition or mixing equipment that allows better control of the process. Equipment specifically designed for in-situ solidification/stabilization operations at pits, ponds, and lagoons is currently being used and marketed commercially. The equipment combines the injection of fly ash or kiln dust into the wastes by use of an injection head using a hydraulic/pneumatic system with the mixing of the materials by the injection head (Figures 6-4 and 6-5). The fly ash or kiln dust is added to the basin material at a predetermined rate until the consistency of the mix is sufficient for setting to occur within 1 to 3 days. An air compressor is used in conjunction with the injector head which is installed on a boom on a tracked vehicle. A hydraulic pump provides the drive for hydraulic motors on the injection head.

In one configuration (Figure 6-4) the hydraulic pump is mounted on the rear of a tracked vehicle for convenience of operation and to counterbalance the injection head boom when the boom is fully extended. Fly ash is delivered to the multibarreled injection head via a compressed air system. Besides providing a delivery system, the pneumatic system also prevents back flow of the basin material into the submerged ends of the barrels. Hydraulically driven augers in the lower section of the barrel force the fly ash out of the barrel into the basin contents. As fly ash is forced from the barrels into the waste, the boom simultaneously moves the injection head back and forth (in the plane of the boom) as well as up and down. This motion provides mixing of the fly ash and basin contents. Approximately 1,000 cu yd of waste material can be solidified per day. This equipment is best applicable to basins deeper than approximately 4 ft. In shallower basins, the necessary pneumatic pressure on the fly ash delivery to the injection heads causes loss of fly ash to the air at the basin surface which results in a burst of fly ash dust. Basins deeper than 4 ft require a larger injection head system and appropriately heavier duty equipment. New adaptations of this equipment which overcome these difficulties have been introduced (see Figure 6-5).

6.5 Mobile Plant Mixing Alternative

Plant mixing refers to those systems which incorporate mobile or fixed units to handle, meter, and mix the solidification/stabilization reagents and the wastes being treated. In this alternative, the wastes being treated are physically removed from their location, mechanically mixed with the solidification/stabilization reagents, and then redeposited in a prepared disposal site. Plant mixing is primarily oriented towards the treatment of pumpable liquids and high-liquid-content sludges; however, special equipment adaptations have been utilized to handle sludges with high solids contents and contaminated soils. A schematic of a typical plant mixing scenario is illustrated in Figure 6-6. Two plant mixing examples will be discussed—one used with pumpable wastes and one with high solids content wastes which must be handled with construction equipment.

6.5.1 Project Sequencing

Many plant mixing systems include all required solidification/stabilization equipment in one trailer- or truck-mounted unit, whereas others are transported in modular form and are put together at the remedial action site.

Basic project sequencing for plant mixing is as follows:

- a. Prepare site for installation of the mobile system. This step includes any necessary utility hookup such as electricity. Some mobile systems have on-board power generation systems and require no onsite power connections.

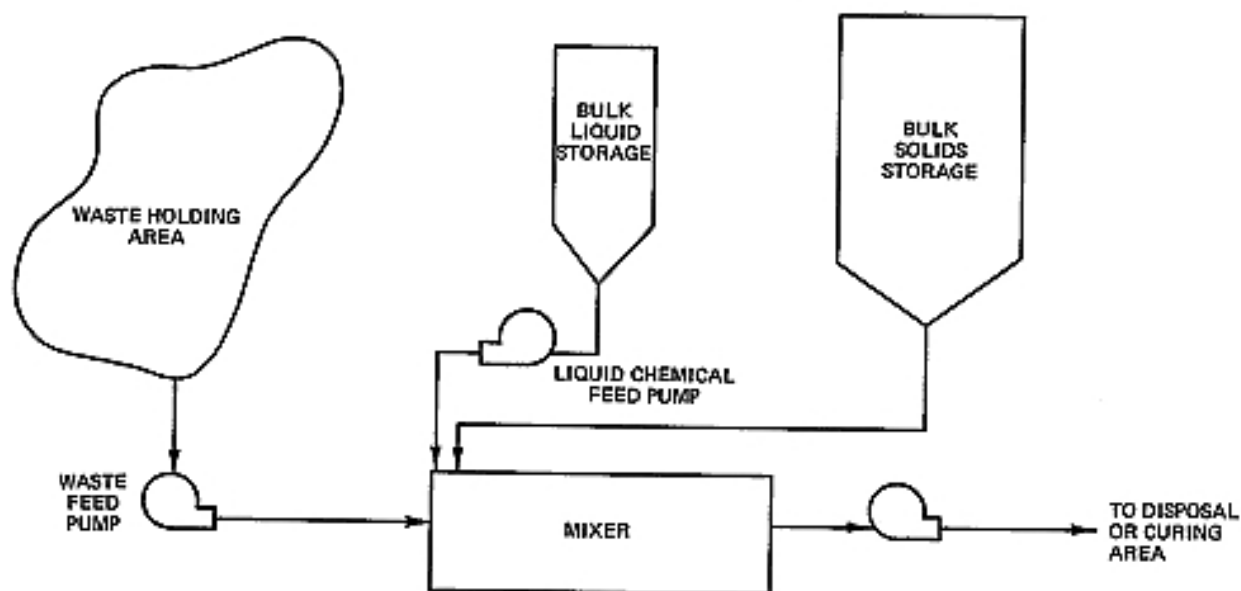

Figure 6-6. Schematic of plant mixing scenario.

- b. Prepare final disposal area for solidified/stabilized wastes.
- c. Install raw and treated waste handling systems. These usually include centrifugal or diaphragm pumps with electrical or gasoline-powered drivers, but they may be simple construction equipment for high-solids wastes.
- d. Transport the portable system to the remedial action site and erect equipment, interfacing with utilities.
- e. Initiate solidification/stabilization process and monitor as required.

6.5.2 Equipment Requirements

Mobile, trailer-mounted plants may come complete with chemical storage hoppers, chemical feed equipment, mixing equipment, and waste handling equipment. Some mobile plants have on-board power generation facilities; however, more commonly, an onsite power hookup or separate power generation system is required. Although the basic concept for the systems illustrated is identical, significant variations exist in the details of construction of each. Variations found in those systems examined during this study were in the mounting configuration (trailer or closed van), in the types of chemical feed systems, in the types of mixing apparatus, and in the setup requirements.

Both weight- and volume-based chemical feed systems are used. Volumetric-based systems are utilized exclusively for the addition of liquid reagents, whereas the addition of bulk solid reagents may be controlled with either weighing conveyor systems, batch weighing systems, or volumetric screw feeder systems. Flow of the waste is controlled by the capacity of the transfer pumps used to transfer the wastes from the holding area to the mixing vessel.

A variety of mixing systems have been successfully used on the mobile plants currently in use. These include ribbon blenders and single and double shaft rotor mixers. The type of mixer utilized appears to have little effect on the quality of the final product, but production efficiency may be affected. Illustrations and photographs of currently available mobile mixing plants in operation are presented in Figures 6-7 through 6-11.

The design of mobile plants has been oriented toward the treatment of liquids and light slurries. Materials handling is most often accomplished using pumps. The capacity of the typical mobile plant ranges from 60,000 to 150,000 gal per 24-hr day of waste material treated. The controlling factor in determining capacity is generally the handling characteristics of the waste materials being treated. Thus the capacity of the same equipment will vary significantly from job to job. The size of the equipment applicable to mobile plants is limited by weight, length, and width restrictions associated with over-the-road transportation requirements.

Modular plant systems consist of separate pieces of equipment that can be tailored more closely to fit specific site requirements. Whereas mobile plants are usually self-contained on one van or trailer, modular plants are usually delivered to the site on several trailers. Typical modular plant installations are illustrated in Figures 6-12 through 6-14.

The typical modular plant will include equipment modules for: onsite chemical storage, usually a silo; chemical feed system, usually a weight batching system; a mixing system of a type dependent on the waste materials being treated; a raw waste handling system of a type also dependent on the waste material; and a final product handling system.

The modular system illustrated in Figure 6-12 is designed primarily to handle liquids and light flowable sludges up to 30% solids content. Mixing is accomplished in a 1-1/2-cu yd ribbon blender. Waste materials can be charged to the ribbon blender using pumps, a clamshell, or a front-end loader. Mixing time is approximately 1-1/2 to 2 min depending on the material being handled. Solidified/stabilized material is discharged at the base of the ribbon blender and removed by front-end loader. Material can be transported to the final disposal site by dump truck.

The modular system illustrated in Figure 6-14 is designed to handle heavy materials such as contaminated soils and low moisture content sludges. In this particular application, the waste materials were slurried in order to ensure reaction with the solidification/stabilization agents. A unique aspect of this system was the use of concrete transit mixers to mix the

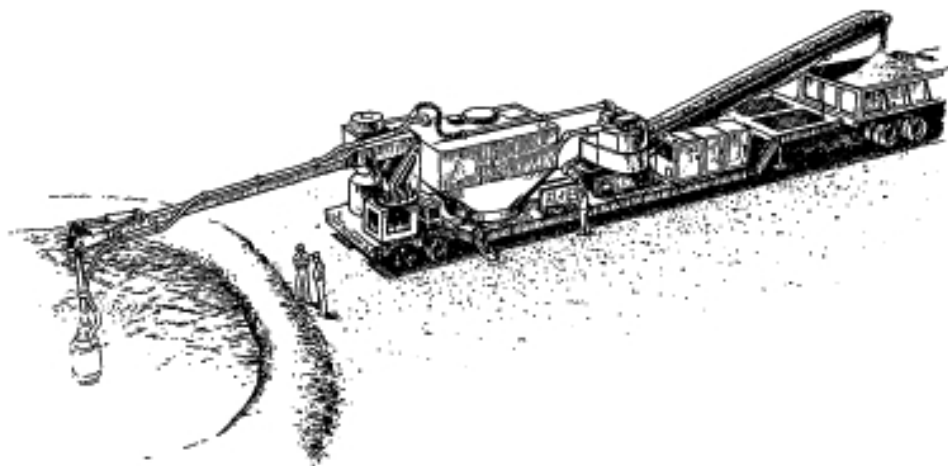

Figure 6-7. Schematic of a trailer-mounted mobile mixing plant (Courtesy Beardsley & Piper).

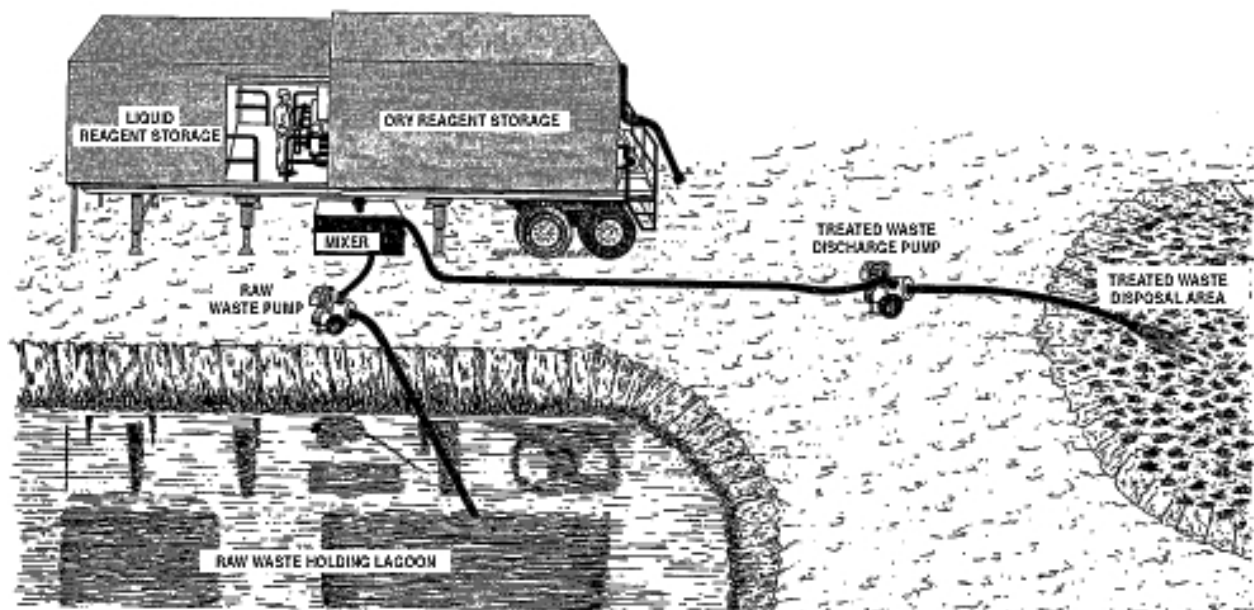

Figure 6-8. Schematic of a van-mounted mobile mixing plant (Courtesy Chemfix).

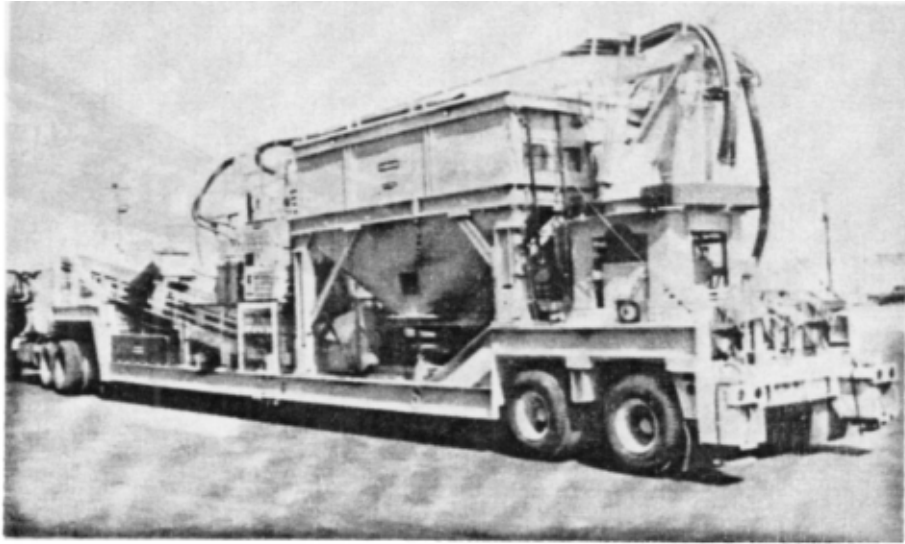

Figure 6-9. Open mobile mixing plant (Courtesy Beardsley & Piper).



Figure 6-10. Enclosed mobile mixing plant (Courtesy Chemfix).

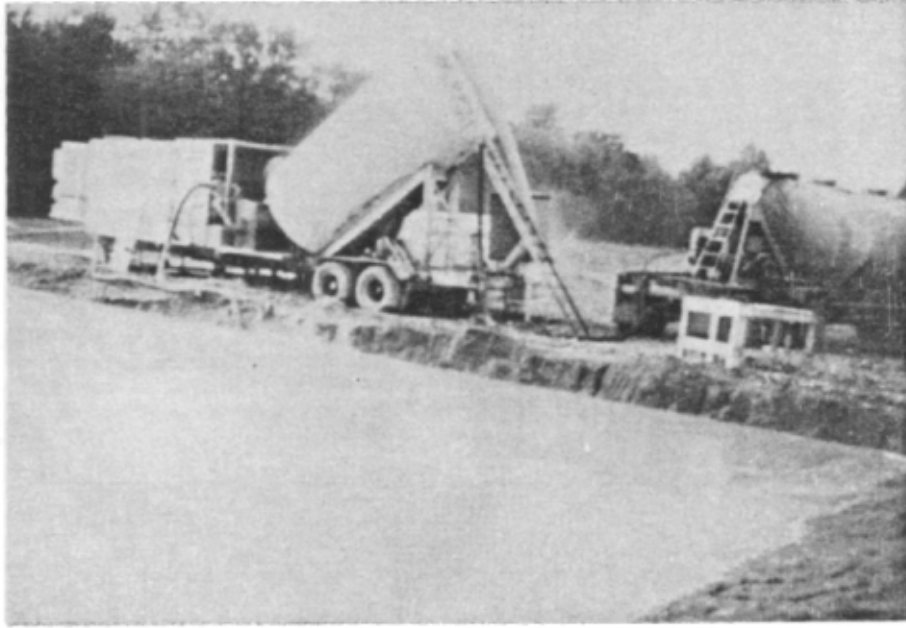

Figure 6-11. Drum handling mobile mixing plant (Courtesy Solid Tek).

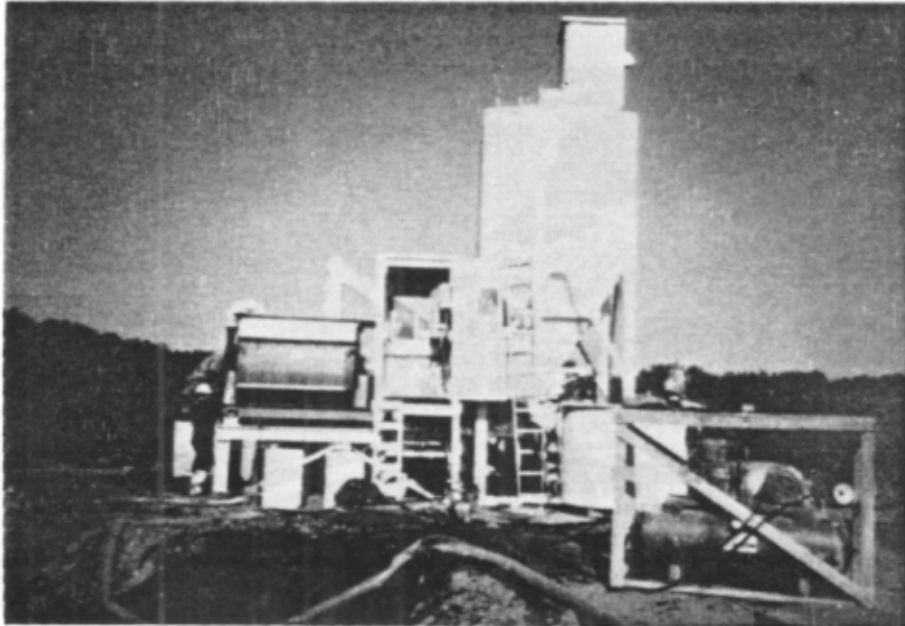

Figure 6-12. Small modular mixing plant (Courtesy Solid Tek).

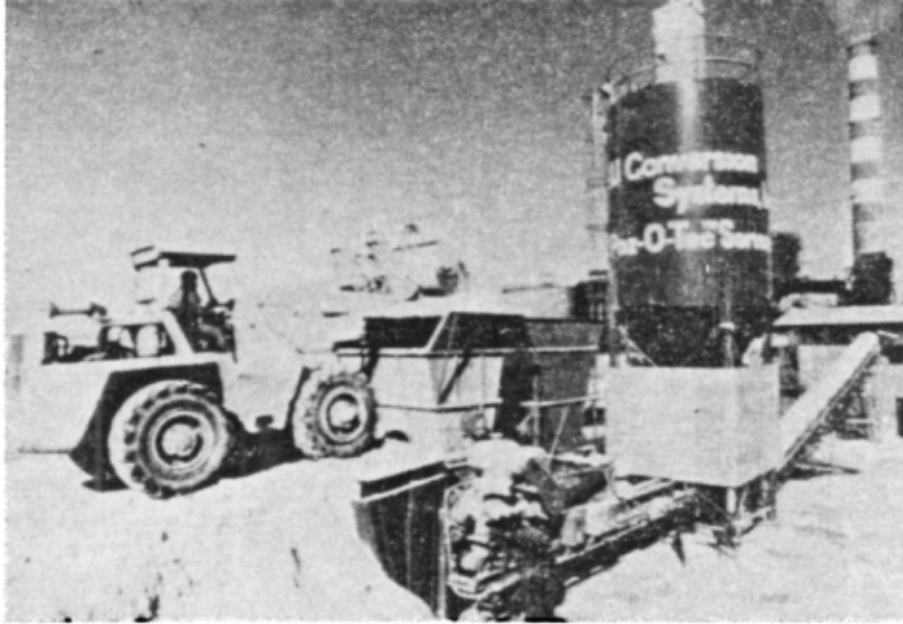

Figure 6-13. Large modular mixing plant (Courtesy IU Conversion).

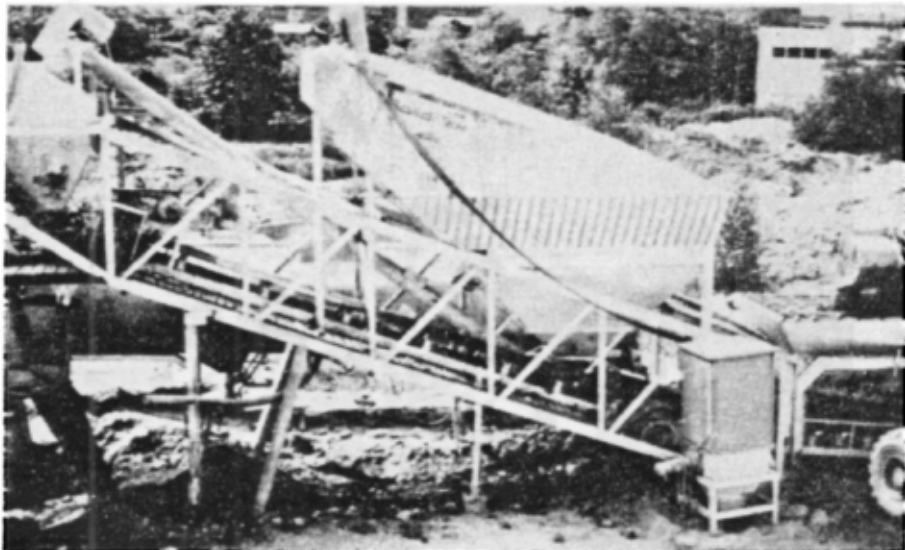

Figure 6-14. Modular mixing plant for heavy slurries (Courtesy Solid Tek).

wastes with the reagents. Reagents and waste materials were batched into the transit mixer. Mixing was accomplished while in transit to the final disposal site.

6.5.3 Costs

The costs of using mobile or portable mixing plants for a particular project are dependent on the process selected (reagent to be added) and the waste material being handled. These factors are the primary variables in determining the production rate on a particular project. Project costs include both fixed costs (i.e. transportation to and from the site and setup costs) and variable costs (i.e. chemicals and processing labor), which depend on the quantity and type of material treated.

General ranges of costs for application of both mobile and portable mixing plants to remedial action sites were provided by the owners of equipment discussed previously. Costs ranged between \$20.00 and \$75.00 per cubic yard of material treated. These costs included handling of the waste materials from their existing holding area to an onsite disposal site. Costs presented do not include the further handling of the material at the disposal area or capping and landscaping of the disposal area.

6.5.3.1 Mobile Mixing Plant for Pumpable Wastes.

The procedure for estimating the cost of mobile plant solidification/stabilization of a pumpable waste is presented below and summarized in Table 6-3.

a. Assumptions.

- (1) Approximately 500,000 gal of waste liquids and pumpable sludges in an open lagoon are to be solidified using a two reagent process consisting of Portland cement and sodium silicate.
- (2) Bench-scale studies indicate that the reagents need to be added in weight-to-weight ratios of 30% Portland cement and 2% sodium silicate.
- (3) An onsite disposal area is available.
- (4) The onsite cost of the reagents is \$55.00 per ton for Portland cement and \$0.10 per pound for liquid sodium silicate.
- (5) The remedial action site is located 200 miles from the nearest mobile unit.

TABLE 6-3. COST ESTIMATES FOR THE MOBILE PLANT MIXING
ALTERNATIVE FOR PUMPABLE WASTES

Note: Stabilization/solidification with 30% (w/w) Portland cement and 2% sodium silicate of 500,000 gal (2,850 tons) of pumpable sludge (85 lb/cu ft) in a mobile mixing plant with daily throughput of 250 cu yd (10 days required). Onsite disposal available.

TREATMENT REAGENTS:

30% Portland cement	= 855 tons × (\$55/ton)	= \$47,025	
2% sodium silicate	= 57 tons × (\$200/ton)	= \$11,400	
Total costs of treatment reagents:		<u>\$58,425</u>	\$20.50/ton

LABOR COST FOR TREATMENT

1 ea Project supervisor	= \$27.50/hr × 80 hr	= \$ 2,200	
2 ea Technicians @ \$18.50	= \$37.00/hr × 80 hr	= 2,960	
2 ea Laborers @ \$12.50	= 25.00/hr × 80 hr	= 2,000	
Total labor cost:		= <u>\$ 7,160</u>	\$ 2.51/ton
Expenses: @\$75/day for 5 men 10 days		= \$ 3,750	\$ 1.32/ton

EQUIPMENT RENTAL:

	Capacity	Value	Per hour	Per 10 days
2 ea Trash pumps	(6 in.)	\$31,000	\$20/hr =	\$1,600
1 ea Mobile plant		180,000	120/hr =	9,600
Total rental cost:				<u>\$11,200</u> \$ 3.93/ton

MOBILIZATION-DEMobilIZATION AND CLEANUP:

Labor and expenses for 3 days:	\$2,148 + \$1,125	= \$3,273	
Transportation: 200 mile/trip × 2 trips × \$2/mile		= 800	
Total		<u>\$4,073</u>	\$ 1.43/ton

TOTAL COST OF TREATMENT:	500,000 gal = \$84,608	\$29.69/ton
PROFIT AND OVERHEAD (@ 30% of cost)	= \$25,382	\$ 8.91/ton
TOTAL CONTRACTED PRICE:	500,000 gal = \$110,000	\$38.60/ton

- b. Mobilization and demobilization cost. Mobilization costs are those costs incurred in preparing the equipment for shipment, transporting the equipment, and setting the equipment up for actual waste processing; these costs include labor costs and transportation costs. Demobilization includes cleanup of site and equipment and transportation back to origin. These activities are expected to take about 3 days total. Transportation is the cost of actually transporting the equipment. The estimated cost of transporting the equipment is \$2.00 per load mile. Assuming that there will be the equivalent of two tractor trailer loads, we obtain a \$4.00 per mile cost.
- c. Project duration. Total processing time is based on the estimated production rate of the mobile unit. For the material to be processed, a production rate of 250 cu yd per day (8-hr shift) is assumed so that 10 working days is necessary to treat the entire lagoon (2,475 cu yd). This includes only the solidification activity.
- d. Cost summary for plant mixing of pumpable wastes. Plant mixing techniques used with pumpable wastes are the least expensive of the alternatives developed here, except for the in-situ mixing scenario. The efficiency is largely due to the economical movement of the materials by pumps rather than by loading and trucking. For applicable wastes, this method permits precise reagent addition and complete and uniform mixing, both of which are lacking in the in-situ methodology at this time. This tighter control of mixing proportions and duration gives the ability to precisely tailor the reagent addition for maximum efficiency and effectiveness. The use of less reagent to attain adequate stabilization results in less final product to be disposed of which often makes this method quite competitive with in-situ methodology.

6.5.3.2 Modular Mixing Plant for Unpumpable Wastes.

The procedure for estimating the cost of in-situ solidification/stabilization for a high solids waste is presented below and summarized in Table 6-4:

- a. Assumptions.
 - (1) Approximately 500,000 gal of nonpumpable, high solids sludge is to be solidified using a two reagent process consisting of Portland cement and liquid sodium silicate.
 - (2) Bench-scale studies indicate that the reagents must be added in weight-to-weight ratios of 30% Portland cement and 2% sodium silicate.
 - (3) Onsite equipment will include a mobile plant that has a silo for cement storage, a weight batcher for control of the cement feed, a ribbon blender for mixing, a front-end loader for

TABLE 6-4. COST ESTIMATES FOR THE MODULAR PLANT MIXING ALTERNATIVE FOR UNPUMPABLE OR SOLID WASTES

Note: Stabilization/solidification with 30% (w/w) Portland cement and 2% sodium silicate of 500,000 gal (2,850 tons) of unpumpable sludge or solid waste (85 lb/cu ft) in a mobile mixing plant with daily throughput of 180 cu yd (14 days required). Onsite disposal available.

TREATMENT REAGENTS:

30% Portland cement	= 855 tons × (\$55/ton)	= \$47,025	
2% sodium silicate	= 57 tons × (\$200/ton)	= \$11,400	
Total costs for treatment reagents:		<u>\$58,425</u>	\$20.50/ton

LABOR COST FOR TREATMENT

1 ea Project supervisor	= \$27.50/hr × 112 hr	= \$ 3,080	
1 ea Technician	@ \$18.50 = \$37.00/hr × 112 hr	= 2,072	
2 ea Truck drivers	@ \$15.00 = 30.00/hr × 112 hr	= 3,360	
2 ea Laborers	@ \$12.50 = 25.00/hr × 112 hr	= 4,928	
Total labor cost:		= <u>\$13,440</u>	\$ 4.72/ton
Expenses: @ \$75/day for 6 men 14 days		= \$ 6,300	\$ 2.21/ton

EQUIPMENT RENTAL:

	Capacity	Value	Per hour	Per 14 days	
1 ea Mobile plant		\$125,000	\$82.25 =	\$ 9,212	
1 ea Front-end loader	2 yd	44,000	29.40 =	3,293	
2 ea Dump trucks	12 yd	54,000	33.60 =	3,987	
1 ea Backhoe	1.2 yd	68,000	44.70 =	5,006	
Total rental cost:				<u>\$21,498</u>	\$ 7.54/ton

MOBILIZATION-DEMOBILIZATION AND CLEANUP:

Labor and expenses for 4 days:	\$3,840 + \$1,800	= \$5,640	
Transportation: 200 mile/trip × 2 trips × \$2/mile	=	800	
Total		<u>\$6,440</u>	\$ 2.26/ton

TOTAL COST OF TREATMENT:	500,000 gal = \$106,103	\$37.23/ton
PROFIT AND OVERHEAD (@ 30% of cost)	= \$31,831	\$11.17/ton
TOTAL CONTRACTED PRICE:	500,000 gal = \$137,934	\$48.40/ton

materials handling, two dump trucks to transport the raw and treated wastes, and a backhoe to load raw waste into the dump truck.

- (4) An onsite disposal area is available.
 - (5) The onsite cost of the reagents is \$55.00 per ton for Portland cement and \$0.10 per pound for the sodium silicate.
 - (6) The remedial action site is located 200 miles from the nearest portable unit.
- b. Mobilization and demobilization costs. Mobilization costs are those incurred in preparing the equipment for shipment, transporting the equipment, and setting the equipment up for actual waste processing. Mobilization costs include labor, equipment, and transportation costs. Demobilization costs include site and equipment cleanup and transportation of equipment back to its source. These activities are expected to take 4 days to complete. Transportation is the cost of actually transporting the equipment. There are two loads to be transported at a cost of \$2.00 per load mile.
- c. Project duration. Estimated production rate for the modular mixing plant and peripheral equipment is 180 cu yd per day. Thus about 14 working days are required to process the 2,475 cu yd (500,000 gal). This includes only the solidification activity.
- d. Cost summary for plant mixing of unpumpable wastes. The more expensive and time-consuming handling and transportation of high solids waste which cannot be moved by pumps, or transport distances which make pumping impractical, increase the cost of the plant mixing alternative. Labor and equipment costs are about doubled in the example given here (Table 6-4) over the more easily handled, pumpable wastes so that this is the most expensive of the bulk-handling treatment options. This method does retain the precision of reagent dosing and mixing uniformity so that some efficiencies can be gained by producing treated waste with a lower proportion of treatment reagents, and therefore less total volume for disposal. This method is often the method of choice for highly toxic or hazardous wastes since the mixing process is under close control.

6.5.4 Safety and Environment

Special safety and environmental concerns associated with plant mixing include the generation of odors, organic vapors, and fugitive dust. Under normal conditions, the process is open to the atmosphere and thus presents a greater potential for problems than pumping liquid wastes or in-drum mixing. Equipment moving around the site should be decontaminated daily. Stationary processing equipment should be cleaned as operational requirements necessitate and decontaminated after project completion.

Standard personnel protective measures should be implemented as necessary, depending on the waste being handled. The reduction in production efficiency can be anticipated as a direct function of the level of protective apparatus required. Level A protection is anticipated to reduce production rate by 50 to 75 percent.

Quality control for plant mixing scenarios is expected to be better than that associated with area and in-situ mixing and similar to that obtainable with in-drum mixing. The material handling and rehandling requirements give better control of the chemical addition and mixing process; however, they also provide added potential for offsite contamination.

The solidification equipment proposed above should incorporate several fail-safe design features. First, the motor for the mixer is located outside the solidification area and contains a hand crank. This permits emptying of the mixer should the process be stopped in mid-stream due to motor failure or loss of electrical power. Maintenance on the motor can also be performed without entering a contaminated area. Second, the system flush is controlled through a flush module mounted outside the solidification area, again for maintenance purposes. The flush water is kept under pneumatic pressure at all times so that it is available even during loss of electrical power. Capped containers are inspected and tested for external contamination and decontaminated if necessary. The container is labeled and stored for shipment to the final disposal area.

6.5.5 Modifications

Both mobile and modular mixing systems have been developed for the solidification of low-level radioactive waste materials usually associated with the nuclear power industry. These facilities are similar in concept to the mobile plants that have been developed for the treatment of hazardous wastes; however, the attention given to operator safety is significantly greater than that associated with the hazardous waste plants. The primary concern is shielding of the operator and decontamination of equipment that has come in contact with the waste materials. Use of remote and automatic control systems is stressed in the nuclear environment. The emphasis on safety generally raises the cost per unit of waste treated with these systems significantly above that typically found in the treatment of hazardous wastes. The number and kinds of modifications of mobile and modular treatment facilities are as numerous as the vending companies which offer their services, as can be seen in the illustrations (Figures 6-7 to 6-14). They vary in size from large, semipermanent installations at very large sites which can treat 500 to 1,000 cu yd per day, to very small, portable units which treat 10 to 50 cu yd per day. Mixing, storage, and measuring facilities also are sized and changed to optimize the equipment for the specific job and level of hazard encountered.

A modification of the plant mixing alternative is the use of the plant to add and mix the reagents with the waste materials and then package the treated materials in drums. This modification incorporates the bulk materials handling

features of plant mixing with the secure containerization features of in-drum mixing. If containerization is required, this procedure offers significant labor saving over the in-drum scenario. These savings, however, are substantially offset by the cost of the drums. Field experience indicates that approximately 300 drums per 8-hr shift could be handled using a typical portable mixing plant. Costs for this modification are anticipated to range between \$30.00 and \$50.00 per drum (\$0.55 to \$0.91 per gallon). Figure 6-15 illustrates a portable plant being used for this purpose.

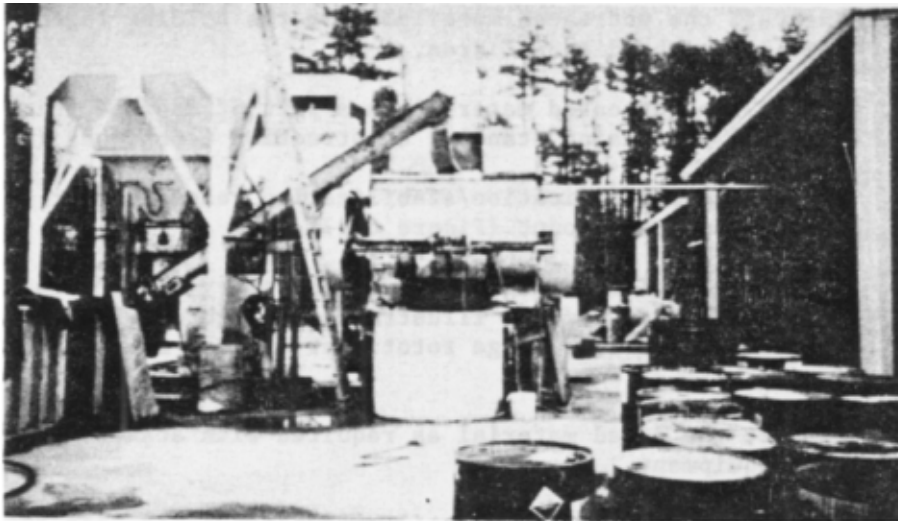

Figure 6-15. Portable plant mixing followed by drum encapsulation (Courtesy Solid Tek).

6.6 Area Mixing or Layering Alternative

Area mixing, or in-place layering, provides an economical method for stabilization/solidification of homogeneous and nonhomogeneous waste liquids and sludges. The system avoids the use of conventional, stationary mixing equipment. The waste is placed in layers over the disposal area in lifts of from 2 in. to 24 in., depending upon its consistency and handling ability. The waste is then overlaid with a layer of treatment reagents which have been selected for the specific waste being treated. Once the two lifts are placed, a mechanized vehicle lifts and turns the layer much like a rototiller, using multiple passes. The resulting mixture is left to air dry and/or is compacted in-place using standard earth compaction equipment. Additional layers are then constructed over the lift in an identical manner until the final height of material has been attained. Typically the final lift is covered with earth, seeded, and maintained as the final cap. Alternatively, after mixing, the treated waste can be removed to a final disposal area using standard earth-moving equipment; but this may leave a very large area to clean up if hazardous wastes are being treated.

6.6.1 Project Sequencing

Project sequencing for area mixing is patterned after the construction techniques used for the soil cement or lime stabilization of roadway subbase materials. A typical project incorporates the following steps:

- a. Select and prepare the onsite disposal area.
- b. Excavate the untreated material from the holding lagoon and transport it to the disposal area.
- c. Spread the untreated material in a lift of desired thickness on the disposal area using standard construction techniques (Figure 6-16).
- d. Spread the solidification/stabilization reagents over the material in the required amount (Figure 6-17).
- e. Mix the materials using a high-speed rotary mixer such as a pulvimeter. This equipment, illustrated in Figure 6-18, works in a manner similar to a large rototiller and can mix layers up to 24 in. in depth.
- f. Compact the mixed material as required with standard roadway compaction equipment.
- g. Repeat steps b through f until all material has been treated or until the designed depth of material has been attained.

6.6.2 Equipment Requirements.

Equipment requirements are based on the nature and quantity of waste material to be treated. An additional consideration is the location, topography, and size of the remedial action site. Minimum equipment requirements would include a backhoe, clamshell, or front-end loader to excavate the material from the holding lagoon; one or two dump trucks to haul the material to the disposal site; a motor grader, excavator, or dozer to spread the material in lifts; a high speed rotary mixer; a dry-chemical spreader; and a pneumatic-tired roller or vibratory compactor.

Depending on the size of the project, additional equipment could be efficiently added. Production rates will be a function of equipment size, mix, and quantity. Production rates ranging from 400 to 500 cu yd per day were obtained with the following equipment mix: two 10-yard dump trucks, two excavators, two chemical spreaders, two high-speed rotary mixers, two compactors, and one motor grader.

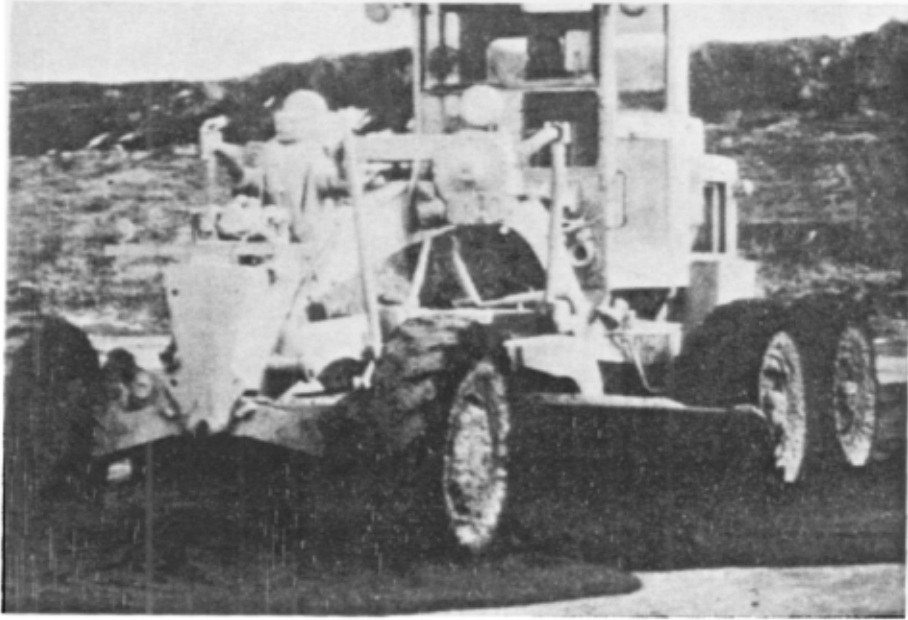

Figure 6-16. Spreading untreated material for area mixing (Courtesy Soil Recovery).

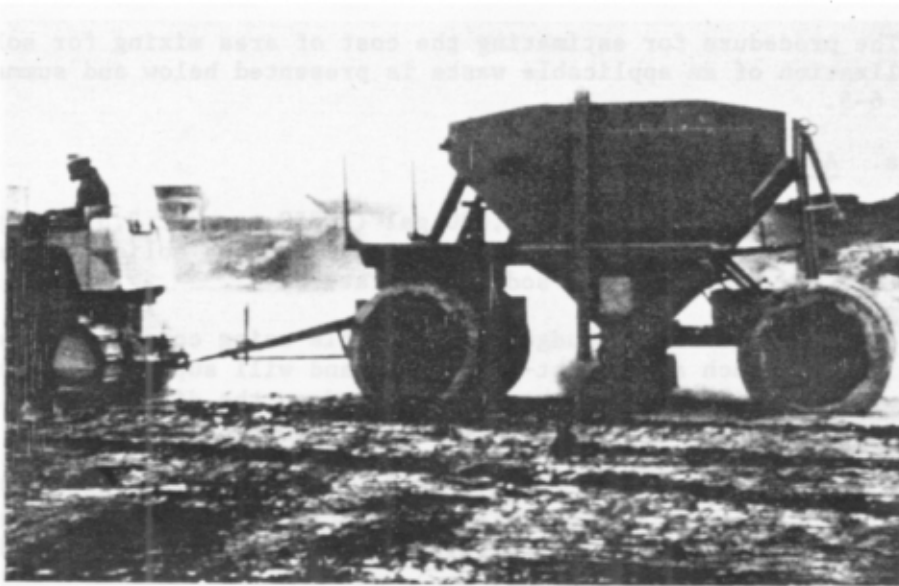

Figure 6-17. Adding stabilization/solidification reagent for area mixing (Courtesy Soil Recovery).

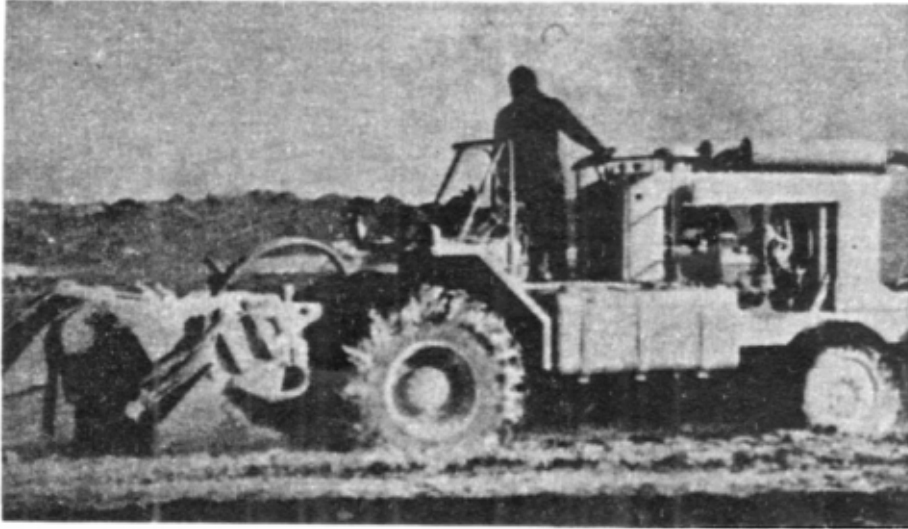

Figure 6-18. Mixing waste materials with stabilization/solidification reagents in area mixing (Courtesy Soil Recovery).

6.6.3 Costs

The procedure for estimating the cost of area mixing for solidification/stabilization of an applicable waste is presented below and summarized in Table 6-5.

a. Assumptions.

- (1) Approximately 500,000 gal (2,850 tons or 2,575 cu yd) of non-pumpable, high solids sludge is to be solidified using 30% cement and 2% sodium silicate.
- (2) The waste sludge is handleable using construction equipment such as a front-end loader and will support the spreading and mixing equipment when layered on the disposal area. Sludges often must be pretreated in situ with an absorbent such as fly ash to produce such a handleable product. Pumping lower solids sludges onto the disposal site to dry to a manageable solids content is feasible, but the additional time required and the low lift height attainable by this method often makes this option infeasible.
- (3) Onsite cost of cement is \$55.00 per ton; sodium silicate is \$200 per ton.
- (4) The waste site is 200 miles from the nearest equipment.

TABLE 6-5. COST ESTIMATES FOR THE AREA MIXING (OR LAYERING) ALTERNATIVE

Note: Stabilization/solidification with 30% (w/w) Portland cement and 2% sodium silicate of 500,000 gal (2,850 tons) of high solids waste (85 lb/cu ft) in 12-in. lifts of waste to which a reagent layer is added and mixed with a high speed rotary mixer. Daily capacity is 250 cu yd (10 days required). Onsite disposal available.

TREATMENT REAGENTS:

30% Portland cement = 855 tons × (\$55/ton)	= \$47,025	
2% sodium silicate = 57 tons × (\$200/ton)	= \$11,400	
Total cost of treatment reagents:	<u>\$58,425</u>	\$20.50/ton

LABOR COST FOR TREATMENT

1 ea Project supervisor	= \$27.50/hr × 80 hr =	\$ 2,200	
3 ea Heavy eq. operators @ \$22	= 66.00/hr × 80 hr =	5,280	
3 ea Truck drivers @ \$15	= 45.00/hr × 80 hr =	3,600	
1 ea Laborer	= 12.50/hr × 80 hr =	1,000	
Total labor cost:	=	<u>\$12,080</u>	\$ 4.24/ton
Expenses: @ \$75/day for 8 men 10 days	=	\$ 6,000	\$ 2.11/ton

EQUIPMENT RENTAL:

	Capacity	Value	Per hour	Per 10 days
1 ea Front-end loader	2 yd	\$44,000	\$29.40 =	\$ 2,352
1 ea Dump truck	12 yd	27,000	17.80 =	1,424
1 ea Chem. spreader	8 ton	22,500	14.80 =	1,184
1 ea Rotary mixer	12 ft	36,000	23.70 =	1,896
1 ea Roller compactor	14 ton	28,000	18.75 =	1,500
1 ea Motor grader	14 ton	61,500	40.63 =	3,250
Total rental cost:				<u>\$11,606</u> \$ 4.07/ton

MOBILIZATION-DEMobilIZATION AND CLEANUP:

Labor and expenses for 1 day:	\$1208 + \$600	=	\$1,808	
Transportation: 200 mile/trip × 4 trips × \$2/mile		=	1,600	
Total			<u>\$3,408</u>	\$ 1.20/ton
TOTAL COST OF TREATMENT:	500,000 gal =	\$ 91,519		\$32.11/ton
PROFIT AND OVERHEAD (@ 30% of cost)		= \$ 27,456		\$ 9.63/ton
TOTAL CONTRACTED PRICE:	500,000 gal =	\$118,975		\$41.75/ton

- (5) Sufficient land area is available at the site for the complete treatment process.
- b. Mobilization and demobilization costs. Transportation of equipment to the site is estimated to require four trips of 200 miles with flat-bed trucks @\$2.00 per mile, for \$1,600 total. Other than transportation costs, area mixing requires little equipment setup or break-down at the waste site since only standard construction equipment is required. One day should be sufficient for equipment cleanup. Unusual preparation of the disposal site (such as grading uneven terrain or installing leachate collection systems or final cover) is not included in these costs.
- c. Project duration. The daily production rate, considering loading, transporting, spreading, mixing and compacting operations, is estimated to be about 250 cu yd per day when using a single loader and dump truck, and an eight-man crew (see 6.6.2, above). Therefore, approximately 10 days would be required to complete the 2,575 cu yd of waste. Some efficiencies might be realized by using a larger crew with more or larger equipment.
- d. Summary of area mixing costs. Project costs are dependent upon the quantity of material treated, the distance to the disposal site, the amount and size of equipment used, and the type of reagents selected. Cost estimates for area mixing of 500,000 gal of waste are summarized in Table 6-5 in a form comparable with that used for the other alternatives. Total cost of treatment in this example is about \$32 per ton (~\$28 per cu yd) of which about 65% is for treatment reagents and about 20% each for labor and equipment.

Costs shown include disposal site preparations, excavation of waste material, transportation to treatment and disposal area, treatment reagents, and mixing and compaction of the treated product. Not included are any pre-treatment costs, land cost (which may be quite high), capping and revegetation of the site, treatment of any decanted liquid, or removal of the waste to a final disposal site, if necessary. Total costs reported for actual remedial site stabilization projects including all of the above-listed parameters have run from \$95 to \$105 per cu yd (110 to \$120 per ton).

6.6.4 Safety and Environment

Special safety and environmental concerns associated with the plant area mixing scenario are similar to those associated with in-situ and plant mixing. Of primary concern is the generation of fugitive dust, release of organic vapors, release of odors, and decontamination of equipment. Each of these areas of concern should be addressed in detail in the overall remedial action plan.

To date, the use of the area mixing scenario has generally been limited to the treatment of oil sludges and other semisolid wastes with relatively

low associated hazard levels so that little emphasis has been given to associated safety and environmental concerns. The potential for offsite release of contaminants, particularly fugitive dust and vapor releases, should receive additional scrutiny should this scenario be adopted.

6.6.5 Modifications

Major modifications have not been identified. Modifications are expected to be limited to the types of solidification reagents used in the process and the types of equipment used to handle the waste materials and solidification reagents.

6.7 Summary

The number of waste processing, handling, and mixing technologies is as varied as the number of treatment reagent-waste formulations. Waste and site characteristics, and reagent cost and availability are the major factors which must be weighed in project planning to ascertain the most cost-efficient and reliable containment strategy. This section has discussed a representative sampling of possible stabilization/solidification scenarios, all of which are currently available commercially. This should give the reader a good understanding of the wide diversity of applicable technology now in use. A formal decision process outline as recommended for remedial action alternatives is discussed in an EPA Guidance Manual (U.S. EPA 1983).

6.7.1 Comparison of Treatment Alternative Costs

Attributes of the four stabilization/solidification alternatives discussed in this section are summarized in Table 6-6. Similar assumptions were used in all of the alternative cost estimates, as were production rates from actual equipment now in use at remedial action sites. It is emphasized that these estimates are for comparison purposes only and cannot be extended to specific wastes and/or sites, as cost and reliability of all processing technologies are quite waste- and site-specific.

In-drum mixing is by far the most expensive and takes the greatest amount of production time due obviously to the very small quantities processed in each batch. Mixing done inside the drum is reasonably complete but difficulties are often encountered in the corners, especially if the complete top of the drum cannot be removed. In-drum mixing is most applicable to sites which have a wide variety of incompatible and highly toxic wastes which occur in individual drums. Since each drum must be analyzed individually (an expense not included in the estimates), customized formulations of reagents and mixing times can be determined for each drum or waste type. The cost of reagent is a small fraction of the whole (generally less than 10%), while labor and equipment make up about half of the total cost. If sufficient

TABLE 6-6. SUMMARY COMPARISON OF RELATIVE COSTS FOR STABILIZATION/
SOLIDIFICATION ALTERNATIVES

Parameter	In-drum	In-situ	Plant Mixing		Area mixing
			Pumpable	Unpumpable	
NOTE: In all cases, 500,000 gal (2,850 tons) of waste was treated with 30% Portland cement and 2% sodium silicate with onsite disposal; costs include only those operations necessary for treatment. All costs are per ton of waste treated. Data taken from Tables 6-1 through 6-5.					
Metering and mixing efficiency	Good	Fair	Excellent	Excellent	Good
Processing days required	374	4	10	14	10
Cost/ton					
Reagent	\$ 20.50 (9%)*	\$20.50 (63%)	\$20.50 (53%)	\$20.50 (42%)	\$20.50 (49%)
Labor and per diem	51.07 (23%)	1.36 (4%)	3.83 (10%)	6.93 (14%)	\$ 6.35 (15%)
Equipment rental	37.14 (17%)	1.38 (4%)	3.93 (10%)	7.54 (16%)	4.07 (10%)
Used drums @ \$11/drum	48.18 (21%)	-	-	-	-
Mobilization-demobilization	15.68 (7%)	1.58 (5%)	1.43 (4%)	2.26 (5%)	1.20 (3%)
Cost of treatment process	\$172.57	24.83	29.69	37.23	32.11
Profit and overhead (30%)	51.72 (23%)	7.45 (23%)	8.91 (23%)	11.17 (23%)	9.63 (23%)
TOTAL COST/TON	\$224.29	32.28	38.60	48.40	41.75

* % of total cost/ton for that alternative.

drums of identical or compatible wastes are found, it is much more economical to bulk the wastes and use other mixing techniques, as this greatly decreases cost and increases mixing efficiencies. This is also true when it is desired to place the treated waste back into drums, either for ease of handling or for increased, short-term containment; the output from bulk mixers usually can be easily loaded directly into new drums or rinsed original drums.

The remaining bulk mixing alternatives are much more consistent in cost and production rates, the two handling liquid or pumpable wastes being the less expensive alternatives. All are quite sensitive to reagent cost since it typically makes up from 40 to 65% of the total cost. The in-situ technique is the fastest and most economical of the bulk methods because the wastes typically need to be handled only once, or not at all if they are to be left in place, as is done with most nonhazardous wastes--only the reagent is handled. Labor and equipment each make up less than 5% of the total treatment cost. However, in-situ mixing is the least reliable because of difficulties in accurate reagent measurement and in getting uniform and/or complete mixing of wastes and treatment reagents. Also, in-situ mixing requires a liquid or a semisolid sludge. If the wastes are to be left in place, the waste site must be dedicated as the final waste disposal area. In some cases, liquid or sludge wastes are stabilized or solidified in situ so that they can later be removed from the site using standard earth-moving equipment.

Mobile or modular mixing plants, although giving excellent mixing and relatively high production rates, require that both the untreated waste and the treated product be handled. The cheapest and fastest material handling technique is that in which the waste can be pumped directly from the waste lagoon, mixed, and then pumped to the final disposal site. Pumpable waste can be treated for about 15% less, in which case, labor and equipment cost each make up only about 10% of the total treatment cost. Nonpumpable waste requires more manpower and machinery for material handling and transport so that labor and equipment costs each increase to around 15%. Plant mixing scenarios are probably the most used alternatives for large amounts of bulk or drummed waste which have a high degree of hazard, as the wastes are always under control of the operators, and reagent dosing is the most accurate and the mixing the most complete of any of the bulk processes.

In area mixing technology, the waste is usually moved only once to the final disposal site where it is mixed and compacted in place. The waste can be removed to another site if needed, but this lessens the other benefits of the technique and leaves large areas to be cleaned up. Very large and standard construction equipment can be used for increased efficiency. Major disadvantages of this technique are that larger land areas are often necessary, and mixing reagent dosing cannot be as accurately controlled.

6.7.2 How Using Different Treatment Reagents Affects Cost

For comparison purposes, all treatment alternatives were developed using the 30% Portland cement and 2% sodium silicate formulation which is about

average in reagent cost. However, this formulation is not really universal as implied. It lends itself especially to in-drum and plant mixing techniques with their better mixing efficiencies, and to inorganic, aqueous sludges with toxic heavy metals. In-situ and area mixing techniques do not usually lend themselves to the addition of liquid reagents (although it has been done) or to formulations where uniform and/or extensive mixing are necessary. The higher unit cost of these reagents tends to limit their use to those techniques with good mixing efficiencies.

Table 6-7 compares the costs of the four alternatives using different amounts of other common treatment reagents with different delivered cost. In these examples it is assumed that the change in reagents will not affect equipment requirements or production rates. Total cost of each alternative and proportional cost of the reagent only are shown in each case.

Changing reagent costs from \$34/ton to \$0/ton has only a small effect on the total cost of in-drum mixing since it is labor- and equipment-intensive. In-situ mixing is the most sensitive to reagent cost, since it is by far the largest part of the total cost of this technique. Other bulk mixing techniques are also quite sensitive to reagent costs; as reagent costs decrease, the proportional differences among the four increase, but their ranking remains the same. The sensitivity of total treatment cost to delivered reagent price is well illustrated in these calculations.

Reagent costs for the other waste products such as fly ash, cement or lime kiln dust, or furnace slag are highly variable. The major component of their cost is usually transportation to the site. The reagent used is typically based upon the nearest source of suitable pozzolanic materials and not through preference of one over the others. As these waste materials have been incorporated into waste treatment systems, they have come to have appreciable value in some areas.

TABLE 6-7. COMPARISON OF TREATMENT COSTS WITH DIFFERENT REAGENTS

Reagent type, amount, and cost	In-drum	In-situ	Plant Mixing		Area mixing
			Pumpable	Unpumpable	
1. 80% fly ash (Type F) @ \$30/ton, 20% lime @ \$50/ton Total reagent cost/ton of waste = \$34					
Reagent cost	12.5%	68%	60%	52%	57%
Total cost/ton	\$237.06	\$49.89	\$56.15	\$65.95	\$59.30
2. 30% Portland cement @ \$55/ton, 2% sodium silicate @ \$200/ton Total reagent cost/ton of waste = \$20.50					
Reagent cost	9%	63%	53%	42%	49%
Total cost/ton	\$224.29	\$23.28	\$38.60	\$48.40	\$41.75
3. 50% fly ash (Type C) @ \$20/ton Total reagent cost/ton of waste = \$10					
Reagent cost	4%	54%	40%	29%	36%
Total cost/ton	\$209.90	\$18.63	\$24.95	\$34.75	\$28.04
4. Free reagent (including delivery)					
Reagent cost	0%	0%	0%	0%	0%
Total cost/ton	\$198.57	\$5.63	\$11.95	\$21.75	\$15.10

NOTE: Data are from Table 6-6. They have been recalculated for different reagent cost, but for the same equipment, project duration, and mobilization costs. All reagent proportions are in weight of reagent per weight of waste.

REFERENCE

U.S. EPA. 1985. Guidance on Feasibility Studies under CERCLA. EPA-540/G-85-003, Office of Emergency and Remedial Response, U.S. Environmental Protection Agency, Washington, D.C., 103 pp.

BIBLIOGRAPHY

- Carson, A. B. 1961. General Excavation Methods. F. W. Dodge Corporation, New York, New York.
- Caterpillar Tractor Co. 1981. Handbook of Earthmoving. Caterpillar Tractor Company, Peoria, Illinois.
- Caterpillar Tractor Co. 1982. Caterpillar Performance Handbook. Caterpillar Tractor Company, Peoria, Illinois.
- Gallagher, G. A. 1981. Health and Safety Program for Hazardous Waste Site Investigation. New England Section of the Association of Engineering Geologists, Boston, Massachusetts.
- Perry, R. H. 1973. Chemical Engineers' Handbook. McGraw-Hill Book Company, New York, New York.
- Peurifoy, R. L. 1956. Construction Planning Equipment and Methods. McGraw-Hill Book Company, New York, New York.
- Peurifoy, R. L. 1975. Estimating Construction Costs. McGraw-Hill Book Company, New York, New York.
- Robert Snow Means Company, Inc. 1983. Site Work Cost Data. Construction Consultants & Publishers, Kingston, Massachusetts.
- Terex. 1981. Production and Cost Estimating of Material Movement with Earthmoving Equipment. Terex Corporation.
- U.S. Army Corps of Engineers. 1980. General Safety Requirements Manual. Washington, D.C.
- U.S. Army Corps of Engineers. 1983. Preliminary Guidelines for Selection and Design of Remedial Systems for Uncontrolled Hazardous Waste Sites. Washington, D.C.
- U.S. EPA. 1980. Closure of Waste Surface Impoundments. SW-873. U.S. Environmental Protection Agency, Office of Waste Management, Washington, D.C.

- U.S. EPA. 1981. Interim Standard Operating Safety Procedures. U.S. Environmental Protection Agency, Washington, D.C.
- U.S. EPA. 1982. Inplace Closure of Hazardous Waste Surface Impoundments. U.S. Environmental Protection Agency. Municipal Environmental Research Laboratory, Cincinnati, Ohio.
- U.S. EPA. 1985a. Drum Handling Practices at Hazardous Waste Sites (Draft). U.S. Environmental Protection Agency, Municipal Environmental Research Laboratory, Office of Research and Development, Cincinnati, Ohio.
- U.S. EPA. 1985b. Remedial Action at Waste Disposal Sites (Revised). EPA-625/6-85-006, Municipal Environmental Research Laboratory, U.S. Environmental Protection Agency, Cincinnati, Ohio.
- U.S. EPA. 1985c. Guidance on Remedial Investigations under CERCLA. EPA-540/G-85-002. Office of Emergency and Remedial Response. U.S. Environmental Protection Agency, Washington, D.C.
- U.S. EPA. 1985d. Remedial Action at Waste Disposal Sites. EPA-625/6-85-006. U.S. Environmental Protection Agency, Washington, D.C.

SECTION 7

QUALITY CONTROL, SAFETY, AND ENVIRONMENTAL CONSIDERATIONS FOR WASTE TREATMENT

The waste stabilization and solidification processes are similar to any chemical treatment operation in that the product must be periodically tested to ensure that the physical integrity and containment characteristics are adequate. The treated waste must be sampled in such a way that representative material is obtained and tested using reliable screening tests to verify performance.

7.1 Sampling of Treated Wastes

Stabilization and solidification systems which are batch operations bear some similarity to batch cement blending systems. Approaches similar to those for fresh concrete can be employed for fluid waste, whereas cured material can be sampled using sampling techniques employed with hardened concrete. Standard ASTM method C 172-71, Standard Method of Sampling Fresh Concrete (U.S. Army 1949; CRD-C4-71) outlines procedures to be used in taking samples from stationary and truck mixers, paving machines, and agitating and non-agitating concrete transports. Standard method CRD-C 620-80 outlines techniques for sampling grouts from mixers, pumps, and discharge lines (U.S. Army 1949).

For solidified or hardened concrete, techniques such as those recommended in ASTM C 823-75 (U.S. Army 1949) or in Abdun-Nur (1978) can be used. In general, careful visual inspection and selected sampling can be used to augment purely random approaches. The objective of any waste testing program is to ensure complete treatment of all materials so that nonrandom testing in areas of poorly performing waste (for example, materials that fail to solidify or have excessive weep water) is justified. If waste treatment is a batch operation, each successive batch should be tested. Some solidification systems that are used with flue gas cleaning wastes have similar problems with regard to producing a consistent set. Interim ponding systems where the treated sludge is allowed to cure for 30 days have been developed to ensure that treatment is complete before disposal. This approach requires double handling of the treated wastes, but it ensures that unsatisfactory materials can be retrieved for reprocessing (Duvel et al. 1978).

7.2 Testing of Stabilized and Solidified Wastes

Early testing of any product that cures slowly presents problems in that the ability to predict the final properties of the cured material from short-term tests is generally poor (Arni 1978). This problem has been thoroughly studied with regard to early strength development in concrete, and no generally satisfactory testing and prediction system has evolved.

In a waste treatment system where the treated material must be placed in a land disposal area shortly after treatment, it is necessary to develop testing that will ensure waste containment in a minimum period of time. This testing can take the form of early strength testing (24-hr compressive strength) and leach testing of cured, ground material (where strength is not a primary consideration). Details of the types of testing that can be used for these purposes are given in Sections 3 and 4 of this report.

7.3 Safety and Environment

In this handbook the solidification/stabilization process is considered to be a subset of the remedial action plan as a whole. As such, it may be assumed that the environmental and safety aspects of the solidification/stabilization process will be addressed in development of the overall remedial action plan. A brief summary of the major safety and environmental aspects of a solidification/stabilization project is presented in the following paragraphs. Detailed safety and environmental guidance may be found in the following publications:

- a. Chemical Manufacturer's Association, Inc. 1982. Hazardous Waste Site Management Plan, Washington, D.C.
- b. Environmental Protection Agency. 1981. Hazardous Materials Incident Response Operations: Training Manual. National Training and Operational Technology Center, Cincinnati, Ohio.
- c. Environmental Protection Agency. 1981. Technical Methods for Investigating Sites Containing Hazardous Substances Training Program. Technical Monograph Nos. 2, 3, and 12.
- d. Environmental Protection Agency. 1985. Remedial Action at Waste Disposal Sites. EPA 625/6-85-006, Office of Emergency and Remedial Response, Washington, D.C.
- e. Meluold, R. W., S. C. Gibson, and M. D. Rogers. 1981. Safety Protection for Hazardous Materials Cleaning: Management of Uncontrolled Hazardous Waste Sites. American Society of Civil Engineers, New York, New York.

- f. U.S. Army Corps of Engineers. 1984. Preliminary Guidelines for Selection of Remedial Actions for Hazardous Waste Sites. EM 1110-2-505 (Draft), Washington, D.C.

7.3.1 Safety

Safety concerns associated with solidification/stabilization of hazardous wastes are primarily related to the protection of onsite personnel. These concerns can be addressed through development of a Personnel Protection Program (PPP). At a minimum, the PPP should include the following elements:

- a. Medical Surveillance Plan.
- b. Industrial Hygiene Support Plan.
- c. Employee Training Plan.
- d. Entry Control Plan.
- e. Respiratory Protection Plan.
- f. Eye Protection Plan.
- g. Skin Protection Plan.
- h. Personnel and Equipment Decontamination Plan.
- i. Emergency Response Plan.
- j. Record Keeping and Reporting Plan.

The detailed requirements of the PPP must be developed on a site-specific basis. Obviously, the more hazardous the waste, the more rigorous must be the PPP.

Good management and work practices, as well as legal requirements, emphasize the need for placing top priority on the health and safety of the worker. Various legal and regulatory requirements establish the minimum guidelines for the development and implementation of a comprehensive health and safety program. The Occupational Safety and Health Administration (OSHA) has established regulations designed to decrease accidents associated with the construction site. Many of these requirements are also applicable to the solidification/stabilization process itself. The regulations may be found in Title 29 of the Code of Federal Regulations. Examples of the specific parts and subparts most likely to apply to the solidification/stabilization scenarios are listed in Table 7-1. Compliance with applicable OSHA regulations should be a mandatory requirement of the PPP. In addition, the EPA has referenced various policies and mandatory requirements for occupational health and safety. A listing of pertinent documents is presented in Table 7-2.

TABLE 7-1. CITATIONS FOR CURRENT OSHA REGULATIONS LIKELY TO BE APPLICABLE AT LAND-BASED DISPOSAL SITES

<u>29 CFR Part 1926</u>	
Subpart D	Occupational Health and Environmental Controls (Sections 1926.50 through 1926.57)
Subpart E	Personal Protection (Sections 1926.100 through 1926.107)
Subpart F	Fire Protection (Sections 1926.150 through 1926.155)
Subpart G	Signs and Signals (Sections 1926.200 through 1926.203)
Subpart L	Ladders and Scaffolding (Sections 1926.450 through 1926.452)
Subpart O	Mechanical Handling Equipment (Sections 1926.600 through 1926.606)
Subpart P	Excavation and Trenching (Sections 1926.650 through 1926.653)
Subpart S	Tunnels and Shafts (Sections 1926.800 through 1926.804)
Subpart U	Blasting and Explosives (Sections 1926.900 through 1926.914)
<u>29 CFR Part 1910</u>	
Subpart Z	Toxic and Hazardous Substances (Sections 1910.1000 through 1910.1046)

TABLE 7-2. POLICIES APPLICABLE TO REMEDIAL ACTIONS

EM 385-1-1, Safety and Health Requirements Manual.

29 CFR 1910, Parts 16, 94, 96, 106, 109, 111, 134, 151, Occupational Health and Safety Standards.

Executive Order 12196, Section 1-201, Sec. (k), Occupational Health and Safety Programs for Federal Employees.

29 CFR 1960.20 (1), Occupational Safety and Health for the Federal Employee.

EPA Occupational Health and Safety Manual, Chapter 7 (1).

EPA Training and Development Manual, Chapter 3, Par. 7 (b).

Occupational Health and Safety Act of 1971, PL 91-596, Sec. 6.

EPA Order on Respiratory Protection (Proposed).

49 CFR, Parts 100-177, Transportation of Hazardous Materials.

EPA Order 1000.18, Transportation of Hazardous Materials.

EPA Order 3100.1, Uniforms, Protective Clothing, and Protective Equipment.

7.3.2 Environment

Environmental concerns during the remedial action project are primarily related to waste containment, to retention of the environment in its natural state to the greatest extent possible, and to the enhancement of site appearance in its final condition. Environmental protection as applied to the remedial action as a whole generally includes consideration of air, water, and land resources. As specifically applied to the solidification/stabilization processes, environmental considerations include the elimination of the spread of contamination through minimization of organic vapor and/or fugitive dust generation, decontamination of personnel and equipment, and prevention and control of spills.

7.3.2.1 Organic Vapor and Dust Generation

Depending on the nature of the wastes found at a site and the solidification/stabilization reagent selected, the possibility exists for a release of volatile organic compounds which may have an adverse impact on

public health. Objectives of the remedial action project must include minimizing the release of organic vapors and monitoring onsite and offsite to measure concentrations and types of vapors that may be released. The potential for volatile organic vapor generation should be addressed during the bench or pilot study phase (Section 5 of this Handbook) of the solidification/ stabilization scenario selection process. Other than elimination or minimization of the generation of organic vapors by a judicious selection process, few technical options are available for control of vapors. The general approach has been limited to the monitoring of organic vapors. Both onsite and site-perimeter monitoring are recommended. Area-type monitoring should be conducted on a periodic basis to determine whether contaminants are migrating out of the contaminated area.

Migration of contaminants through transport of airborne particulates (fugitive dust) could present a significant health and environmental hazard during remedial action activities. Such hazards are particularly likely with large-scale solidification/stabilization scenarios such as in-situ mixing and area mixing. Fugitive dust that could cause a hazard or nuisance to others must be eliminated.

The meteorological conditions at the site will strongly influence the potential for this fugitive dust problems. Hot, dry, windy conditions produce the greatest potential for entrainment and transport of contaminants. The solidification/stabilization reagent and application scenario, as well as the waste being treated, will also affect the amount of fugitive dust formation.

Techniques that can be used during the solidification/stabilization process to mitigate airborne particulate transport include the following:

- a. Minimizing the rehandling of waste materials.
- b. Erecting portable wind screens.
- c. Applying surface stabilizers or dust palliatives.
- d. Using portable surface covers on the work area during periods of inactivity.
- e. Constructing temporary enclosures around the solidification/ stabilization processing area.

7.3.2.2 Equipment and Personnel Decontamination

Although a maximum effort is made to prevent contamination of personnel and equipment, such contamination will inevitably occur as a result of contact with the wastes being treated. Contamination may occur in a number of ways, including the following:

- a. Contacting vapors, gases, mists, or particulates in the air.
- b. Being splashed by materials while sampling, opening containers, or conducting the solidification/stabilization process.
- c. Walking through puddles of liquids or on contaminated materials.
- d. Using contaminated instruments or equipment.

To prevent the spread of contaminants, methods for reducing contamination and decontamination procedures must be developed before the initiation of site operations. Decontamination consists of physically removing the contaminants and/or changing their chemical nature to innocuous substances. The nature and extent of the required decontamination process depends on a number of factors, the most important of which is the type of contaminants being solidified. This topic is treated further in Section 8, Cleanup and Closure.

7.3.2.3 Spill Control

Another important environmental concern is preventing the spread of contamination through spills. A continuous effort should be made to prevent any spillage of contaminated materials during the solidification/stabilization process. A spill control program should as a minimum provide all physical controls possible in areas where spills are likely to occur and proceed in a deliberate and controlled fashion in handling all hazardous materials. Activities presenting the highest probability of material spillage include the transfer of liquid or solid material to a staging area, handling of deteriorated drums of liquid waste, and staging of liquid waste. During solidification/stabilization operations, preventing spills is the responsibility of all workmen at the site.

REFERENCES

Abdun-Nur, E. A. 1978. Techniques, Procedures, and Practices of Sampling of Concrete and Concrete-Making Materials. In: Significance of Tests and Properties of Concrete and Concrete-Making Materials, ASTM Publ 169B, American Society for Testing and Materials (ASTM), Philadelphia, Pennsylvania. pp. 5-23.

Arni, R. T. 1978. Statistical Considerations in Sampling and Testing. In: Significance of Tests and Properties of Concrete and Concrete-Making Materials, ASTM Publ. 169B, American Society for Testing and Materials (ASTM), Philadelphia, Pennsylvania. pp. 24-43.

Duvel, W. A., Jr., et al. 1978. State-of-the-Art of FGD Sludge Fixation. Publication FP-671, Vol. 3, Electric Power Research Institute, Palo Alto, California, not paginated.

U.S. Army. 1949. Handbook for Concrete and Cement, Vols. I and II. U.S. Army Engineer Waterways Experiment Station, Vicksburg, Mississippi, unpaginated, loose leaf.

SECTION 8

CLEANUP AND CLOSURE

After completion of waste treatment and the final placement of the stabilized and solidified waste, it will be necessary to ensure that all equipment is adequately cleaned to prevent material from moving offsite and that the plans for monitoring are implemented in a timely fashion. Programs for decontaminating equipment are generally part of the safety planning involved in the site activity. The postclosure monitoring program is developed as part of the master plan for site closure. Examples of cleanup and closure activities at actual remedial sites are found in EPA (1984).

8.1 Cleanup of Equipment

Stabilization and solidification require extensive mixing and materials handling equipment. Decontamination of equipment may require high-pressure washing systems and manual scraping. Most mixers are cleaned by putting clean material in the mixer and cycling through several mixing operations.

Discarded equipment and cleaning water must be treated as a contaminated waste and be disposed of in an EPA-approved manner. Where residual contamination of equipment is suspected, a swabbing or rinsing procedure and chemical analysis of swabs and rinse water can be used to confirm the effectiveness of the cleaning procedure.

8.2 Site Monitoring

A monitoring system is routinely established at any remedial action site before, during, and after cleanup operations. This system ensures that no adverse impact to air, surface water, or ground water occurs during the remedial activities. These monitoring activities would normally continue after site closure to evaluate the effects of remediation and to act as an early warning system for possible breakdown of liners or other containment structures (EPA 1985a).

If the remedial program involves leaving stabilized or solidified wastes onsite, the monitoring should be designed to ensure that the treated wastes do not become a new source of air or water pollution. The solidified wastes are designed to provide the needed waste containment; therefore, placement of

monitoring wells directly under or adjacent to the solidified waste should be considered in developing the postclosure monitoring plan.

Even structural concrete can break down from exposure and weathering; therefore, the possibility of solidified materials disintegrating or chemical stabilization systems being defeated in natural weathering processes must be considered in monitoring. For example, sulfate-rich ground water can cause swelling and disintegration of Portland-cement/fly-ash-solidified waste, or leaching by rainwater can remove buffering materials in a stabilized waste and allow the pH to drop and metals to be taken into solution in contacting water. If the breakdown of the treated waste is a possible problem, the monitoring program should include the coring and retrieval of solidified waste for leaching tests. Test holes in the wastes can also be filled with clean water, and in-situ leaching rates can be determined.

8.3 Capping of Solidified Wastes

Most solidified wastes are not designed for constant exposure to weathering. Freezing and thawing and wetting and drying can cause the material to fragment badly (Bartos and Palermo 1977). A cap that is thick enough to ensure that the solidified material maintains uniform moisture and is not subjected to freezing is necessary to ensure that the waste does not deteriorate. The cap also should minimize the percolation of water into the waste.

Details on the design of closures are given in Brown and Associates (1982) and Wyss et al. (1980). Selection of soils and vegetation for capping landfills is discussed in detail in Lutton et al. (1979) and for solid hazardous waste in Lutton (1982) and U.S. EPA (1985b).

A program for the periodic inspection and maintenance of the waste caps is generally part of a remedial site master plan.

REFERENCES

- Bartos, M. J., Jr., and M. R. Palermo. 1977. Physical and Engineering Properties of Hazardous Industrial Wastes and Sludges. EPA-600/2-77-139, U.S. Environmental Protection Agency, Cincinnati, Ohio. 89 pp.
- Brown, K. W., and Associates. 1982. Inplace Closure of Hazardous Waste Surface Impoundments. Draft Report, U.S. Environmental Protection Agency Contract 68-03-2943. 92 pp.
- Lutton, R. J., G. L. Regan, and L. W. Jones. 1979. Design and Construction of Covers for Solid Waste Landfills. EPA 600/2-79-165, U.S. Environmental Protection Agency, Cincinnati, Ohio. 274 pp.
- Lutton, R. J. 1982. Evaluating Cover Systems for Solid and Hazardous Waste. SW-872 (NTIS-PB81-181505). U.S. Environmental Protection Agency, Washington, D.C.
- U.S. EPA. 1984. Case Studies 1-23: Remedial Response at Hazardous Waste Sites. EPA-540/2-84-0026, Office of Emergency and Remedial Response, U.S. Environmental Protection Agency, Washington, D.C. 637 pp.
- U.S. EPA. 1985a. Remedial Action at Waste Disposal Sites (Revised). EPA-625/6-85-006, U.S. Environmental Protection Agency, Cincinnati, Ohio. 497 pp.
- U.S. EPA. 1985b. Covers for Uncontrolled Hazardous Waste Sites. EPA-540/2-85-002. U.S. Environmental Protection Agency, Cincinnati, Ohio.
- Wyss, A. W., et al. 1980. Closure of Hazardous Waste Surface Impoundments. EPA-530/SW-873, U.S. Environmental Protection Agency, Cincinnati, Ohio. 100 pp.

APPENDIX A

ACQUISITION AND COSTS OF REAGENTS

One of the items of concern which is associated with all onsite solidification/stabilization alternatives is the ability to obtain the necessary process chemicals and transport them to the proposed project site at reasonable cost. Onsite cost of the required chemicals is a major portion of overall project costs. The cost of chemicals associated with an onsite solidification/stabilization project includes the purchase price from the manufacturer, transportation cost from the point of manufacture to the point of use, cost of onsite storage and handling of the chemicals, and the quantity of chemicals required for a particular project.

A.1 Purchase Price

The purchase price of chemicals is usually the most significant cost associated with the total cost of chemicals for an onsite solidification/stabilization project. Generally, prices are quoted as free on board (f.o.b.) at the manufacturer's plant. The price for chemicals varies from day to day and is a function of a variety of factors including the cost of raw materials and manufacturing at a particular plant location, the current demand for the product as reflected by general economic conditions, the quantity of chemicals to be purchased, the nature of the shipment (e.g. bulk versus bag for cement), and the reactivity of the material.

The major chemicals or materials used in the solidification/stabilization of hazardous wastes are products associated with the construction industry. For this reason, the cost of these materials is strongly related to construction activity. An example is the availability and cost of Portland cement. Increased construction activity results in increased demand which tends to drive prices up. Likewise, decreased construction activity has the opposite effect. Note that this effect is also noticeable in the secondary materials, i.e. cement-kiln dust and lime-kiln dust.

The results of an April 1983 survey of chemical costs for materials commonly used for solidification/stabilization are presented in Table A-1. These costs represent telephone quotes for the materials f.o.b. at the points of manufacture. A wide range of prices can be noted. This range represents geographic differences in material costs. Also note that these prices are probably depressed because of the recent slump in major construction activity. These prices are presented for comparison purposes only.

TABLE A-1. TYPICAL COSTS OF CHEMICALS USED FOR STABILIZATION/
SOLIDIFICATION (APRIL 1983)

Chemical	Units	Cost Range	
Portland cement	\$/ton* (bulk)	\$40	- \$65
Portland cement	\$/ton (bag)	70	- 85
Quick lime (CaO)	\$/ton (bulk)	45	- 55
Hydrated lime (Ca(OH) ₂)	\$/ton (bulk)	45	- 55
Hydrated lime (Ca(OH) ₂)	\$/ton (bag)	60	- 75
Cement kiln dust	\$/ton	5	- 25
Waste quick lime	\$/ton	4	- 10
Fly ash	\$/ton	0	- 40
Gypsum	\$/ton	0	- 35
Sodium silicate	\$/pound	0.05	- 0.20
Concrete admixtures	\$/gallon	1.50	- 9.00

* Customary units are used because price quotations are made in these units.
All prices f.o.b. at point of manufacture.

A.2 Transportation Costs

The cost of transporting chemicals from the point of manufacture to the point of use is generally the second most costly item associated with the total onsite chemical cost for a solidification/stabilization project. In those cases where waste materials (kiln dust) are used as the solidification/stabilization agent, the cost of transportation may actually exceed the cost of the material itself. The materials associated with solidification/stabilization are commonly shipped by rail or truck. For application at remedial action sites, truck haulage has the particular advantage of geographic flexibility, which limits consideration of rail transportation. Therefore, for purposes of this discussion, the costs of chemical transportation to the project site are based on haulage by trucks.

The cost of chemical transportation is primarily a function of the characteristics of the material being handled (specific weight, liquid versus solid, etc.), the quantity of material being transported, the nature of packaging (bulk versus container), the distance over which the material is transported, and the type of carrier performing the transport services.

Because of the quantity of materials required at a typical remedial action site, bulk transport is generally the method used for obtaining the required chemicals. Truck types used for the movement of bulk materials are essentially limited to two: dump trucks (open top with tarpaulin cover) and/or tank-type trucks. Dump trucks are very commonplace and are used for

hauling a variety of materials over relatively short distances. Tank-type trucks are often used in the transport of lime and cement products. The tank-type truck is fully enclosed and is loaded and unloaded pneumatically. The time required to unload the tank-type truck is considerably longer than the dump truck; however, the material is not exposed to the weather, which is a definite advantage. Each type of truck is capable of transporting payloads in the 40,000- to 50,000-pound (20,000- to 25,000-kg) range. The actual payload capacity depends primarily on the specific weight of the material being transported. The tank-type truck is the primary type of carrier employed for the transportation of materials associated with onsite solidification/stabilization projects.

Transportation rates are generally established as a tariff in the case of common carriers, or they are negotiated between the carrier and the manufacturer in the case of contract carriers. For planning purposes, it is easier to develop costs based on common carrier tariffs. Note, however, that these tariffs can vary significantly within a region and certainly across the Nation. The basis for a tariff may vary between carriers in such areas as minimum load and distance traveled. At the planning stage, it is somewhat difficult to compare tariffs directly. In any event, the chemical manufacturer or supplier generally arranges transportation to the site.

Figure A-1 presents typical transportation costs of major chemicals associated with solidification/stabilization technology. The costs presented include the cost of transporting the material from the place of manufacture to the project site. The manufacturer pays loading costs. In the case of bulk shipments, the rate includes the cost of unloading. In the case where packaged materials (lime or cement in bags) are transported, the person to whom the materials are shipped is usually responsible for unloading services (i.e. forklifts, etc.). Bag shipments are usually palletized for easy off-loading.

The basic transportation cost will generally include a free time to effect unloading. Typical free time ranges from 1-1/2 to 3 hr. Should unloading fail to be accomplished in this time frame, demurrage will be charged. These demurrage rates are highly variable and are a function of the demand for transportation services. Typical demurrage rates range from \$20 to \$50 per hour.

A.3 Onsite Chemical Handling

When compared with the purchase costs and transportation costs, the onsite handling costs of solidification/stabilization chemicals are usually minimal. Onsite handling costs incorporate those costs relating to the storage and handling of the chemicals between the time of delivery and the mixing of chemicals with the wastes being treated. The costs of onsite chemical handling are a function of the method of materials delivery (containers or bulk), the nature and quantity of materials being handled, the method of storage, and the method used to mix the chemicals with the waste being treated. Many of these factors are interrelated and difficult to define.

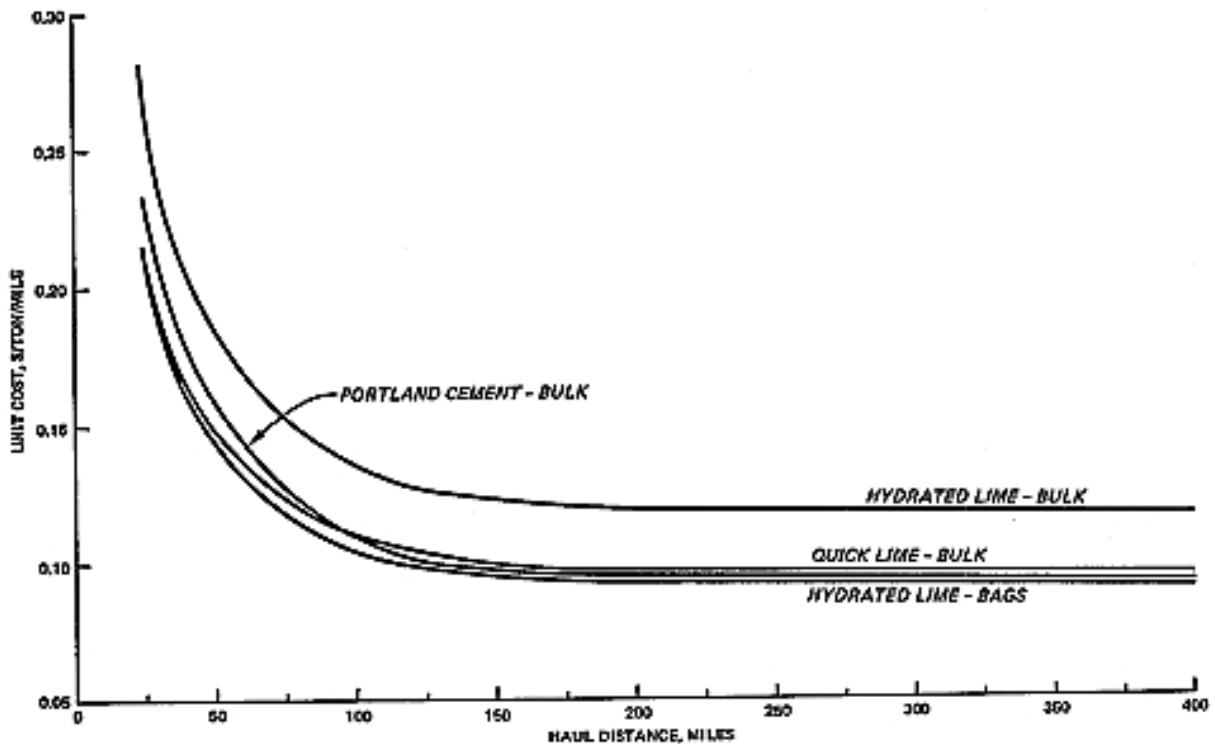

Figure A-1. Typical chemical transportation costs.

Total costs for onsite chemical handling are expected to range from \$0.10 per ton of chemical handled for automated conveyor or pneumatic systems to as high as \$0.50 per ton of added chemical for manual addition methods.

A.4 Quantity and Cost of Chemicals Required

The quantity of chemicals required on a specific remedial action project is the driving force behind all other costs associated with the total onsite chemical costs. The cost of chemicals can represent up to 95 percent of the total cost of an onsite solidification/stabilization remedial action project. The quantity of reagents required to ensure adequate performance of a particular process are usually determined through pilot- or laboratory-scale studies. Reagent requirements can be determined on the basis of volume of reagent per volume of waste, or weight of reagent to weight of waste. For pilot or laboratory studies, it is often easy to determine requirements on a weight/weight basis. Results are usually expressed on a percentage basis (i.e., 20 percent by weight Portland cement to be added).

In the field, it is often more convenient to measure the quantities of wastes on a volume basis such as gallons or cubic yards to be treated. The relationship between volume and weight is expressed as a specific weight, usually in units such as pounds per cubic foot or pounds per cubic yard or

metric equivalents. The specific weight for materials may vary depending on the condition of the material (i.e., natural state, disturbed state, compacted state, etc.). Specific weights for typical materials are presented in Table A-2. Once the volume of waste material to be treated is determined from field surveys, the total weight of material to be treated can be determined by multiplying the volume by the estimated (or measured) specific weight.

Once the total weight of waste materials to be treated is determined, the total quantity of reagents required can be determined using the results of the pilot- or laboratory-scale studies. The weight of reagents required is simply the reagent percent by weight obtained from the pilot or laboratory study multiplied by the total weight of onsite material.

TABLE A-2. SPECIFIC WEIGHTS FOR COMMON MATERIALS AT REMEDIAL ACTION SITES

Material	Weight in bank (lb/BCY)*	Percent swell	Swell factor	Loose weight (lb/LCY)
Ashes, hard coal	700-1,000	8	0.93	650-930
Ashes, soft coal, ordinary	1,080-1,215	8	0.93	1,000-1,130
Ashes, soft coal w/clinkers	1,000-1,515	8	0.93	930-1,410
Cement	2,970	20	0.83	2,465
Clay, natural bed	3,400	22	0.82	2,800
Clay, dry	3,100	23	0.81	2,510
Clay, wet	3,500	25	0.80	2,800
Clay with gravel, dry	2,800	18	0.85	2,380
Clay with gravel, wet	3,100	18	0.85	2,640
Earth, top soil	2,350-2,550	43	0.70	1,650-1,790
Earth, dry	2,450-2,600	43	0.70	1,720-1,820
Earth, moist	2,700-3,000	33	0.75	2,030-2,250
Earth, compacted	3,000	25	0.80	2,400
Earth, w/sand and gravel	3,100	11	0.90	2,790
Gypsum, fractured	5,300	75	0.57	3,020
Gypsum, crushed	4,700	75	0.57	2,680
Kaolin	2,800	30	0.77	2,160
Lime	--	--	--	1,400
Lime, slaked	--	--	--	800-1,500
Limestone, blasted	4,200	6,765	0.570.60	2,400-2,520
Limestone, loose, crushed	--	--	--	2,600-2,700
Mud, dry (close)	2,160-2,970	20	0.83	1,790-2,470
Mud, wet (moderately packed)	2,970-3,510	20	0.83	2,470-2,910
Peat, dry	800-1,300	80	0.56	450-730
Peat, wet	1,600-1,800	80	0.56	900-1,010
Sand, dry	2,450	12	0.89	2,180

(Continued)

* BCY = Bank cubic yards, all specifications are in customary units.
 LCY = Loose cubic yards

TABLE A-2. (Concluded)

Material	Weight in bank (lb/BCY)	Percent swell	Swell factor	Loose weight (lb/LCY)
Sand, dry, fine	2,700	12	0.89	2,400
Sand, damp	3,200	12	0.89	2,850
Sand, wet	3,500	14	0.88	3,080
Sand and gravel, dry	3,300	12	0.89	2,940
Sand and gravel, wet	3,700	11	0.90	3,330
Slag, sand	1,670	12	0.89	1,490
Slag, solid	4,320-4,830	33	0.75	3,240-3,620
Slag, crushed	—	--	--	1,900
Slag, furnace, granulated	1,600	12	0.89	1,420

APPENDIX B

TYPICAL STABILIZATION/SOLIDIFICATION EQUIPMENT

Many of the solidification/stabilization alternatives use similar equipment and/or groups of equipment. The processing equipment used for the solidification/stabilization of hazardous materials at remedial action sites has generally been adapted from the materials processing and construction industries. The equipment or groups of equipment used for the various treatment programs identified in this study have been fabricated from readily available, off-the-shelf equipment modules. The discussion that follows provides information on the technical attributes, available capacities, and costs associated with each identified equipment module.

The equipment that has been adapted for use in solidification operations is divided into four basic categories: chemical storage, materials handling, materials mixing, and materials control. A variety of equipment modules are available under each category. The more common types of equipment modules identified during site visits of operating facilities conducted as a part of this study are the primary focus of this discussion. No attempt has been made to review all available equipment to optimize equipment sizes and mixes.

The cost information presented is based on the purchase cost or rental cost of equipment modules. The costs presented have a July 1983 base year and result from interviews with equipment manufacturers. Note, however, that most of the identified equipment modules are readily available in the used or rental equipment market at substantial cost savings. In addition, the type of equipment generally utilized is designed for portability. As a result, it can be moved from site to site with minimal loss of productive capacity. Thus once it is purchased, the equipment could be amortized over several projects at substantial savings when calculated on a basis of per-unit cost of waste treated.

B.1 Chemical Storage Facilities

Onsite facilities may be required for the storage of both dry and liquid chemicals. The nature and size of required storage facilities are a function of the solidification/stabilization process selected (the types of chemicals required), the quantity of chemicals required, and the method of chemical shipment (bulk or container). Chemical deliveries should be programmed to minimize onsite storage requirements and ensure their continuous availability at the site.

The majority of remedial action projects are assumed to be large enough to justify the bulk purchase of chemicals; however, some specialty chemicals used in the various solidification/stabilization processes may be purchased in smaller, containerized quantities. Therefore, consideration must be given to the protection of both bulk and containerized chemicals during the planning phase.

B.1.1 Dry Chemical Storage

On a volume or weight basis, the major dry chemicals used in a solidification/stabilization process will normally be either Portland cement, quick lime, hydrated lime, fly ash, gypsum, cement-kiln dust, or lime-kiln dust. The quality of these materials, measured by their reactivity, is subject to severe degradation by exposure to moisture from precipitation or excessive humidity. Storage can be provided in one of four ways: open storage, storage with fabric or membrane covers, storage in a warehouse environment, or closed bins and silos.

Open storage can be utilized for short periods of time during appropriate weather conditions for the less reactive dry reagents. Open storage of the more reactive, dry reagents, such as Portland cement and quick lime, would not be appropriate. For example, small amounts of the less reactive dry reagents (e.g., weathered kiln dust) could be stored in the open pending use in an in-situ mixing program without significant loss of reactivity. Fugitive dust may be a severe problem when using this storage option in dry, windy climates. Long-term open storage of dry reagents is not a recommended option. A zero-cost, not including losses of material, may be given to the open storage option.

Storage under a fabric or membrane cover is more appropriate than open storage for low-reactivity materials such as kiln dust, fly ash, or gypsum. Short-term storage in this manner should not result in significant deterioration in these materials. Fugitive dust, however, may still be a significant problem when this method of storage is used. The cost of storage with fabric or membrane covers is estimated to range between \$2.00 and \$4.00 per square foot of storage area provided. The majority of this cost is involved in the cost of the fabric or membrane covering. This category of storage is not appropriate for high-reactivity reagents such as quick lime, hydrated lime, or Portland cement.

Covered storage in a warehouse environment provides an alternative for onsite storage. Unheated warehouse storage can be provided for a cost ranging between \$8.00 and \$10.00 per square foot. Fugitive dust control and access to the materials may present problems. The high reactivity chemicals still may suffer degradation from humidity effects.

Covered storage for the bulk solid materials associated with solidification/stabilization processes is often provided in the form of metal storage silos similar to those used for the storage of Portland cement. Storage capacities ranging from 1,000 to 5,000 cu ft are readily available. The

estimated installed cost for these dry chemical storage silos is presented in Figure B-1.

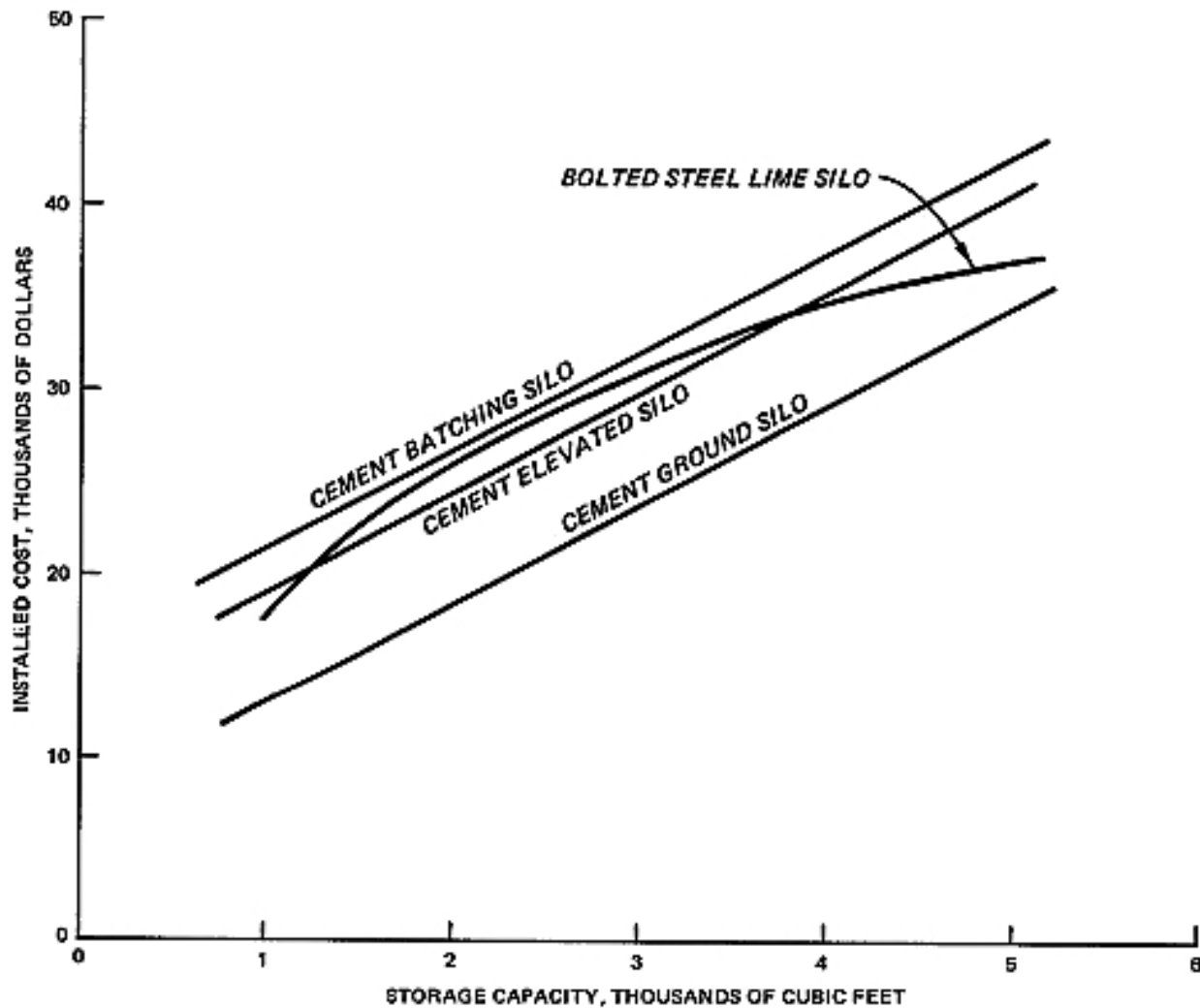

Figure B-1. Installed cost of dry chemical storage.

The required size for a storage silo is a function of the rate of chemical usage and the anticipated chemical delivery schedule. The minimum size silo should be capable of holding at least the quantity of material in a bulk tank truck (approximately 500 cu ft). Material suppliers should be consulted to determine delivery schedules, minimum order quantities, and delivery times.

Containerized dry chemicals (generally bags or drums) can be stored in open storage or covered storage. Some specialty chemicals may require protection from extreme cold or heat. Appropriate covered storage should be provided for such materials. Heated warehouse space can be provided for approximately \$10.00 to \$12.00 per square foot.

Rather than providing for the construction of onsite storage facilities, it may be desirable to use the bulk transport trailer for onsite storage. The cost for long-term use of the bulk transport trailers for such use is subject to extreme variation. Business conditions may preclude the use of this option because of the demand for bulk transportation services and resultant high demurrage rates for bulk trailers. Materials transporters should be consulted during the project planning phase.

B.1.2 Liquid Chemical Storage

Liquid reagents may be received in containers (generally drums) and in bulk form. Containerized liquid reagents may be placed in open storage or covered storage. Although less susceptible to degradation caused by moisture (because of the nature of the shipping container), liquid reagents may be more sensitive to temperature extremes. Changes in both degradation and handling characteristics may result from exposure to temperature extremes. Open and covered storage has been discussed under dry chemical storage above. Similar storage facilities can be provided for liquid chemical storage.

Bulk liquid storage is provided in tanks. Typically, horizontal and/or vertical tanks may be provided. Tanks may be equipped with heating coils to ensure the maintenance of handling characteristics when exposed to low temperatures. The estimated installed costs of various tank storage facilities are presented in Figure B-2. As in the case of dry chemical storage, the proper planning of chemical delivery schedules can be used to minimize onsite storage requirements.

B.2 Materials Handling Equipment

One of the most important factors in the application of solidification/stabilization technology to waste at a remedial action site is the form or nature of the wastes to be processed. The forms that wastes may take include:

- a. Liquids from lagoons, settling ponds, drums, and the container.
- b. Sludges from lagoons, settling ponds, and leaking drums or other containers.
- c. Contaminated soils caused by leaking containers or direct dumping of liquids and sludges on the soil.

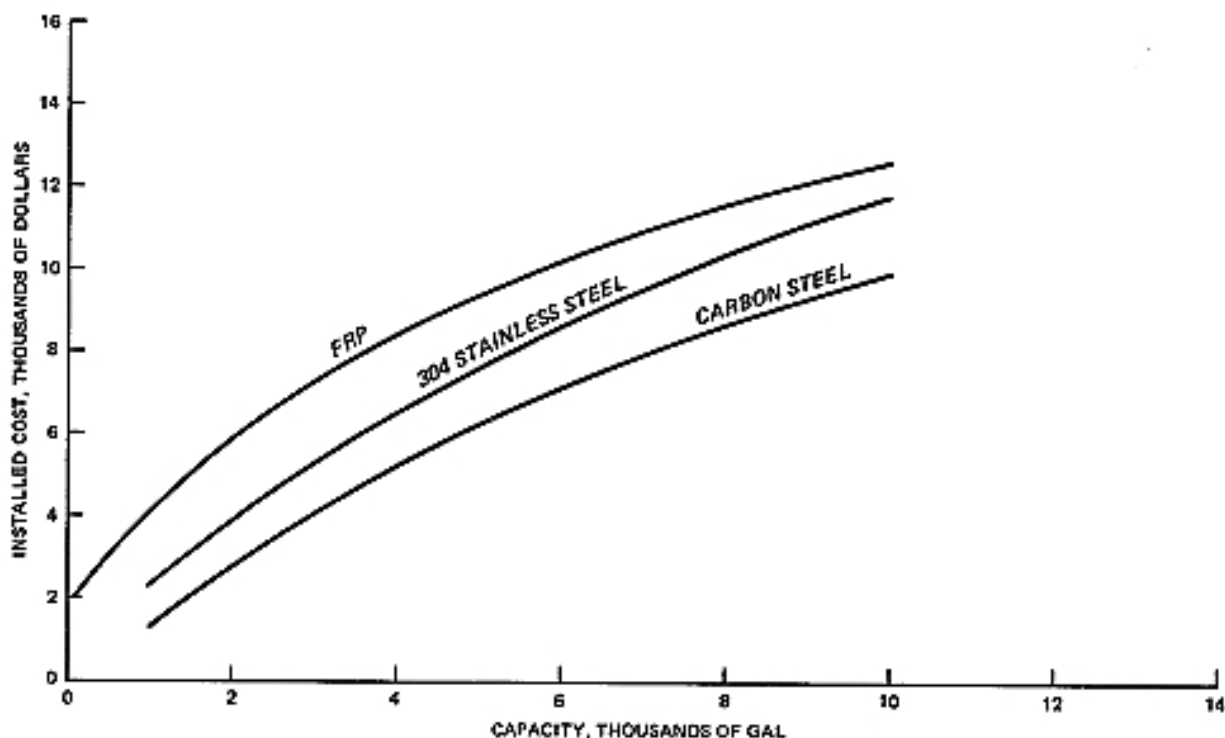

Figure B-2. Installed cost of liquid reagent storage (FRP = fiber reinforced plastic).

- d. Pasty solids from breached and/or intact containers.
- e. Solids in drums or in other containers or from open contaminated sites.

Materials handling equipment selected for a particular remedial action project will depend on the forms of waste to be handled. Selection of equipment for materials handling is a function of the physical characteristics of the waste material being handled (percent solids, viscosity, etc.), the packaging of the waste materials (drums, lagoons, open area, etc.), the quantity of waste materials being handled, and the physical characteristics of the solidified/stabilized wastes. It is desirable to transport liquids and high-moisture-content sludges with pumps. Some low-moisture-content sludges can be handled with special pumps. Low-moisture-content and/or viscous sludges may be handled with earth-moving equipment such as clamshells, backhoes, and dump trucks. Contaminated soils are handled with earth-moving equipment. Material conveying systems can also be utilized for low-moisture-content sludges and contaminated soils. Care must be taken to ensure compatibility between the material to be handled and the equipment selected to do the handling.

B.2.1 Pumps

Either centrifugal or diaphragm pumps may be used for the bulk transfer of liquids and high-liquid-content sludges. Centrifugal pumps have the advantage of higher capacities, whereas diaphragm pumps are capable of handling higher-solids-content materials, but generally have higher maintenance costs. Centrifugal pumps used for handling materials to be solidified or stabilized are generally referred to as self-priming, centrifugal trash pumps (Hicks 1971). Size ranges from 5 cm to 15 cm (2 in. to 6 in.) are commonly available with pumping capacities, based on pumping water, ranging between 95 and 5,100 l/min at heads of up to 56 m. Capacity reductions may be significant for high-solids-content materials. Both motor- and engine-driven pumps are available on frame and trailer-mounted systems. A trailer-mounted, gasoline-engine-driven pump is illustrated in Figure B-3.

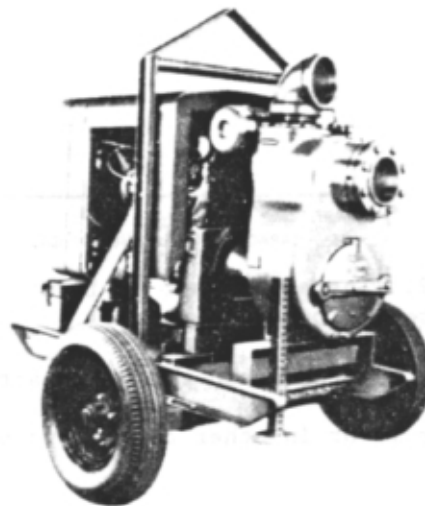

Figure B-3. Trailer-mounted centrifugal pump (Courtesy Gorman Rupp Company).

Self-priming trash pumps are generally limited to handling waste materials with a solids content less than 40 percent. Recent developments in centrifugal pumping systems, incorporating chopper pumps and floating platforms have produced systems capable of efficiently handling slurries containing up to 60% solids. Commonly available sizes range from 7 cm to 15 cm (3 in. to 6 in.) with pumping capacities, based on pumping water ranging between 1,000 and 5,200 l/min at heads up to 44 m. As in the case with the self-priming, centrifugal pumps, capacity reductions are significant when pumping sludges with high solids content. Since the pump impeller on the floating system is in contact with the waste slurry, the floating system can handle a higher-solids-content slurry. Figure B-4 illustrates a typical floating pump system.

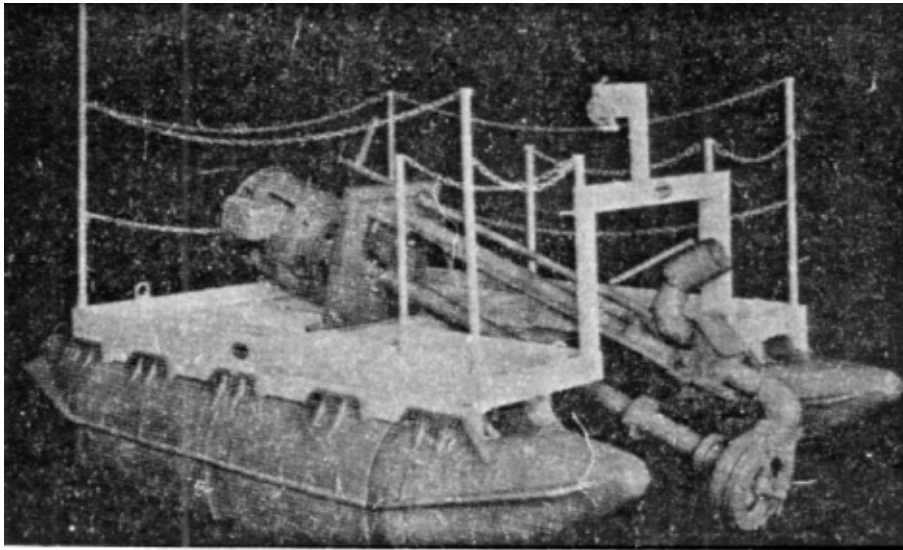

Figure B-4. Typical floating centrifugal pump (Courtesy Vaughan Pump Company).

Diaphragm pumps can be utilized on more viscous material with higher solids content; however, capacities and head are generally limited, and maintenance costs are higher. Commonly available diaphragm pump sizes range from 40 to 570 l/min at heads up to 8 m. Both electric and engine-driven diaphragm pumps are available.

Figure B-5 presents the purchase costs for self-priming centrifugal trash pumps, floating centrifugal pumps, and diaphragm pumps.

Waste materials that have been mixed with solidification/stabilization reagents can also be transported with pumping systems. In addition to the systems described above, concrete pumps have been used to transport treated waste materials. Available capacities range from 40 to 120 cu yd/hr. Concrete pumps can handle very high solids content slurries; however, the high cost of these systems has prohibited their wide-scale use. Figure B-6 presents the purchase cost of available units.

B.2.2 Construction Equipment

In those cases where waste material which is not amenable to pumping is to be handled, reliance has been placed on the use of conventional excavation and earth-moving equipment. Typically, equipment used for the solidification/stabilization of waste materials will include backhoes or all-purpose

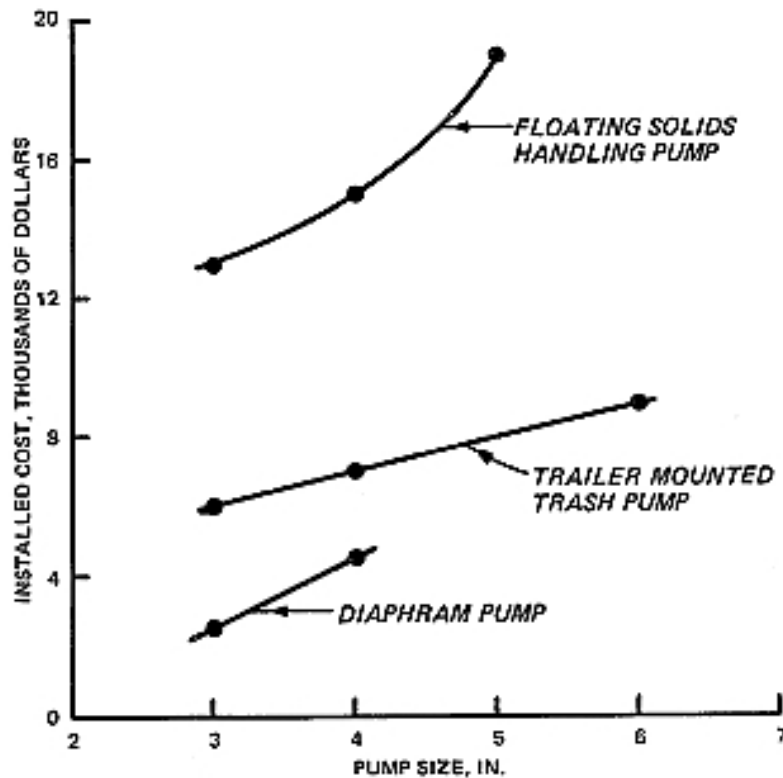

Figure B-5. Typical costs for pumping systems.

excavators, clamshells, or draglines; front-end loaders; and dump trucks. Figure B-7 illustrates a backhoe-dump-truck operation for removal of contaminated soils. Other types of equipment including graders, dozers, compactors, etc. may be used in the overall remedial action project; however, this discussion is limited to consideration of materials handling associated with the solidification/stabilization process.

The required materials handling equipment is available in a wide range of sizes. The selection of quantity, types, and size of equipment is primarily a function of the quantity of materials to be handled and the working area available.

Production rates for construction equipment used on remedial action projects may vary significantly. Estimates of production rates are beyond the scope of this study; however, a number of excellent references are readily available to assist the project planner in preparing production and cost estimates (Terex 1981; Caterpillar Tractor Co. 1981, 1982). In addition, direct consultation will often be provided by the equipment manufacturer.

Estimation of the production rates expected on a particular job requires careful preparation, a thorough knowledge of the material to be handled, and a complete understanding of equipment capabilities. Factors to be considered

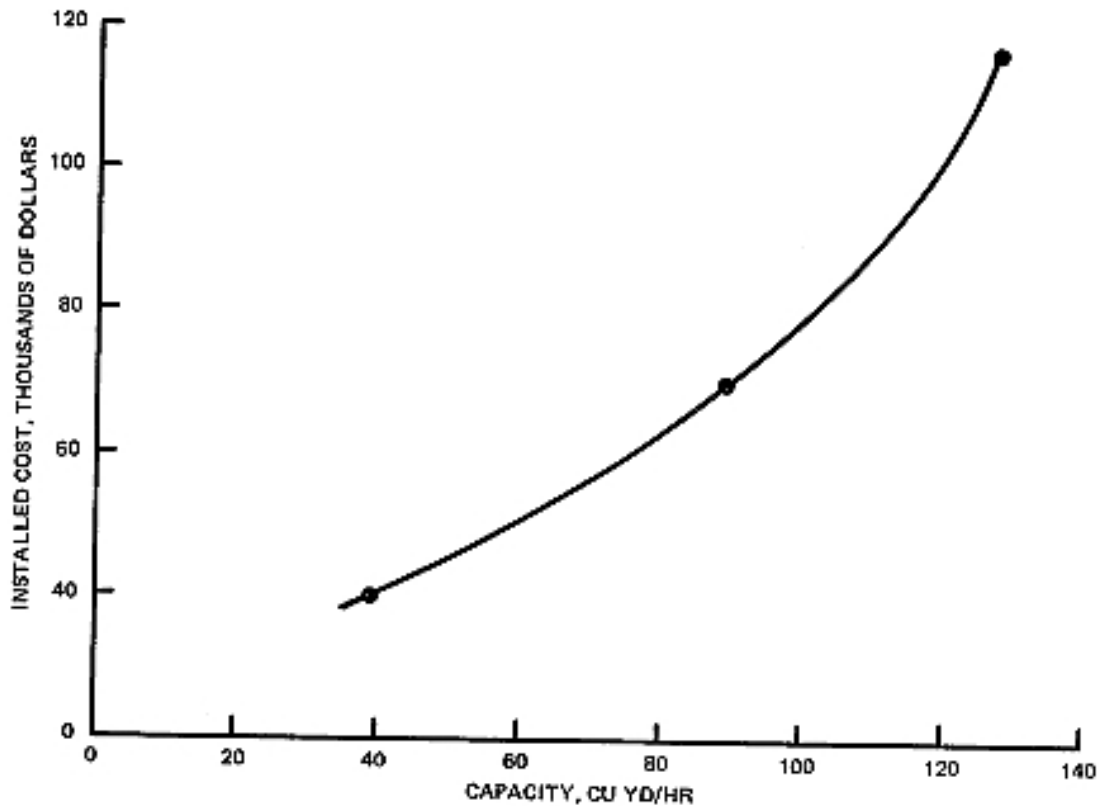

Figure B-6. Typical costs for trailer-mounted concrete pumps.

in preparation of the estimate include (1) cycle time of materials-moving components; (2) job efficiency factors; (3) material weights, swell factors, and handling characteristics; and (4) vehicle payloads.

The cycle time in construction activities is defined as the time for a machine or group of machines to complete one cycle (i.e., load, haul, dump, return, spot, and delay). Each of these components affects the total cycle time and is controlled by a number of factors. Loading factors include: size and type of loading equipment, nature of material being handled, capacity of hauling equipment, and skill of the operator. Haul factors include: capability of hauling unit, hauling distance, haul road conditions, and grades. Dumping, or unloading, factors include: destinations of material (i.e. fill, stockpile, mixer, etc.), conditions of unloading area, maneuverability of the hauling unit, and nature of the material. Return factors include: capability of the hauling unit, return distance, haul road condition, and grades. Spot factors include maneuverability of the hauling unit, maneuver area available, type of loading machine, and location of the loading equipment. Delay factors include time spent waiting on the loading unit and time spent waiting to unload.

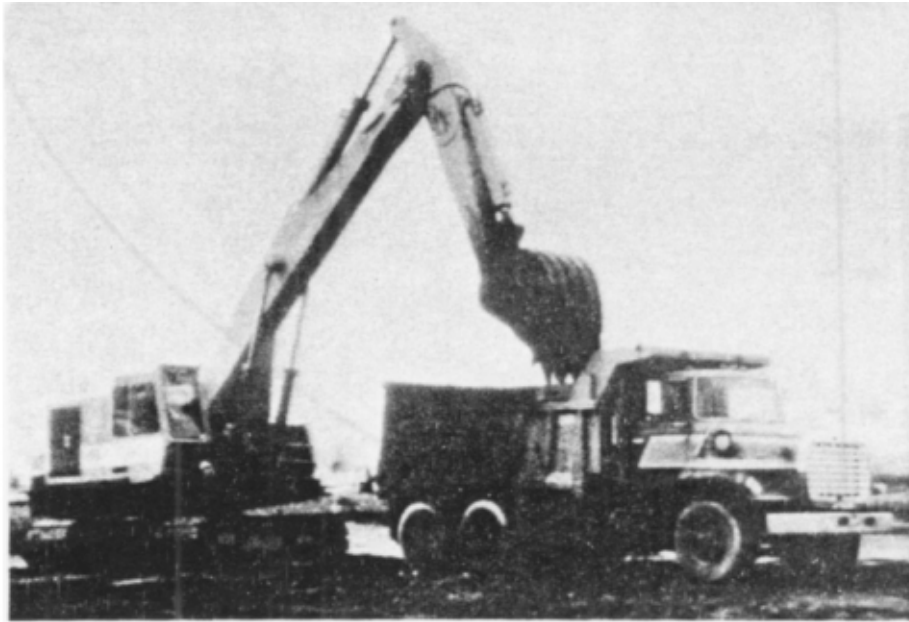

Figure B-7. Backhoe-dump-truck operation for removal of contaminated soils (Courtesy Albert H. Haiff Associates).

Job efficiency factors are used to estimate the sustained or average materials handling capability over a long period of time. Job efficiency is influenced by such factors as operator skill, repair time, personnel delays, and job layout (Caterpillar Tractor Co. 1982). Since many of these factors are difficult to quantify, estimates of job efficiency are very complex. Typical job efficiency factors are presented in Table B-1. Note that a 75% efficiency (45 min/hr) is estimated for a job with good working conditions and good management. Job efficiency factors as low as 25% may be anticipated for some remedial action projects due to safety factors and nonoptimum working conditions.

Weight and handling characteristics of materials being moved are also important factors in determining production rates. Materials handled with construction equipment on typical remedial action projects are low-moisture-content sludges with difficult handling characteristics. Specific weights of the materials in-place are expected to vary between 700 and 1,400 kg/cu m. The materials may also be subject to swelling and/or hardening in the loading equipment.

Payloads for the loading and hauling equipment must be determined from the manufacturer or his representative. Again, it must be noted that payload data are developed based on earth and rock loading and hauling capabilities. Few if any data are available on handling of the waste materials that are candidates for solidification/stabilization.

TABLE B-1. TYPICAL JOB EFFICIENCY FACTORS

Job condition	Management condition			
	Excellent	Good	Fair	Poor
Excellent	0.84	0.81	0.76	0.70
Good	0.78	0.75	0.75	0.65
Fair	0.72	0.69	0.69	0.60
Poor	0.63	0.61	0.61	0.52

Once production estimates have been developed, the onsite requirement for each piece of construction equipment can be estimated. With this time estimate, the job cost of each item of equipment can be estimated. Equipment can be either purchased or rented. Of course, purchased equipment can be amortized over more than one project. For planning purposes, the normal procedure is to estimate costs based on equipment rental rates. Table B-2 provides information on the rental rates for various items of construction equipment anticipated to be required on a typical remedial action project.

B.2.3 Conveyors

Belt conveyors, or stackers, can be used to transport materials with soil-like properties (i.e., contaminated soils or the solidified/stabilized waste material). Belt conveyors are not suitable for the transport of liquids, high-moisture-content sludges, or viscous materials. Portable conveying systems from 15 m to 70 m in length with 60-cm through 90-cm belt widths are readily available. Capacities range from 300 to 700 tons/hr. Estimated costs for an installed, portable conveyor system are presented in Figure B-8. Figure B-9 illustrates a typical portable conveyor system.

B.2.4 Drum Handling

Waste to be solidified or stabilized is often stored in drums. Efficient drum handling has been one of the most difficult problems in materials handling associated with remedial action projects. Appropriate procedures have been defined in the publication entitled "Drum Handling Practices at Hazardous Waste Sites" (EPA 1982).

TABLE B-2. APPROXIMATE RENTAL RATES FOR CONSTRUCTION EQUIPMENT USED FOR STABILIZATION/SOLIDIFICATION PROJECTS

Equipment	Per Month (176 hr)	Per Week (40 hr)	Per Day (8 hr)	Approx. Purchase Price
Compactors - self-propelled				
Vibratory plates	\$ 1,450.00	\$ 485.00	\$ 140.00	\$ 25,500.00
3 wheel steel (14 ton)*	1,600.00	535.00	150.00	28,000.00
Tandem (14 ton)	1,600.00	535.00	150.00	28,500.00
Rubber tired (11 ton)	1,600.00	535.00	150.00	24,000.00
Vibratory drum (10 ton)	2,495.00	800.00	235.00	41,000.00
Graders	3,300.00	1,100.00	325.00	61,500.00
14 ton	4,650.00	1,550.00	450.00	83,500.00
19 ton	6,350.00	2,100.00	600.00	110,000.00
25 ton				
Front-end loaders	1,550.00	525.00	150.00	28,500.00
1 cu yd	2,400.00	825.00	235.00	44,000.00
2 cu yd	5,250.00	1,750.00	500.00	93,000.00
4 cy yd	6,250.00	2,100.00	600.00	112,000.00
5 cu yd				
Crawler tractors				
140 hp	2,950.00	1,000.00	290.00	52,500.00
300 hp	3,700.00	1,900.00	550.00	102,000.00
400 hp	8,650.00	2,900.00	835.00	156,000.00
Wheel tractors				
180 hp	3,750.00	1,250.00	360.00	66,200.00
300 hp	6,200.00	2,050.00	600.00	113,500.00
420 hp	7,250.00	2,400.00	685.00	128,000.00
Hydraulic pull shovel				
1-1/2 cu yd	5,100.00	1,700.00	495.00	95,000.00
2 cu yd	6,350.00	2,100.00	610.00	115,000.00
3 cu yd	7,950.00	2,650.00	770.00	143,000.00
All purpose excavators				
1/2 cu yd	3,875.00	1,275.00	380.00	71,600.00
3/4 cu yd	5,725.00	1,900.00	560.00	103,000.00
1-1/4 cu yd	7,450.00	2,500.00	715.00	133,000.00

TABLE B-2. (Concluded)

Equipment	Per Month (176 hr)	Per Week (40 hr)	Per Day (8 hr)	Approx. Purchase Price
Mechanical shovels				
2 cu yd	4,950.00	2,000.00	575.00	100,000.00
3-1/4 cu yd	10,000.00	3,300.00	900.00	170,000.00
4-1/4 cu yd	12,500.00	4,150.00	1,200.00	220,000.00
5-1/2 cu yd	17,500.00	5,950.00	1,700.00	320,000.00
Hydraulic crane				
10 tons	3,150.00	1,050.00	300.00	56,000.00
15 tons	3,250.00	1,100.00	310.00	59,000.00
18 tons	3,550.00	1,250.00	340.00	65,000.00
35 tons	6,400.00	2,150.00	620.00	120,000.00
Mechanical crane-crawler				
20 tons	3,850.00	1,250.00	375.00	71,500.00
30 tons	4,300.00	1,450.00	410.00	77,000.00
40 tons	6,000.00	2,000.00	575.00	110,000.00
50 tons	6,600.00	2,175.00	625.00	115,000.00
Truck crane				
25 tons	4,750.00	1,550.00	450.00	82,500.00
50 tons	7,000.00	2,350.00	675.00	125,000.00
Water pumps				
2-in. discharge	120.00	40.00	12.00	2,300.00
3-in. discharge	210.00	70.00	20.00	3,750.00
4-in. discharge	510.00	175.00	50.00	8,800.00
6-in. discharge	850.00	285.00	80.00	15,500.00
8-in. discharge	1,000.00	330.00	95.00	18,000.00

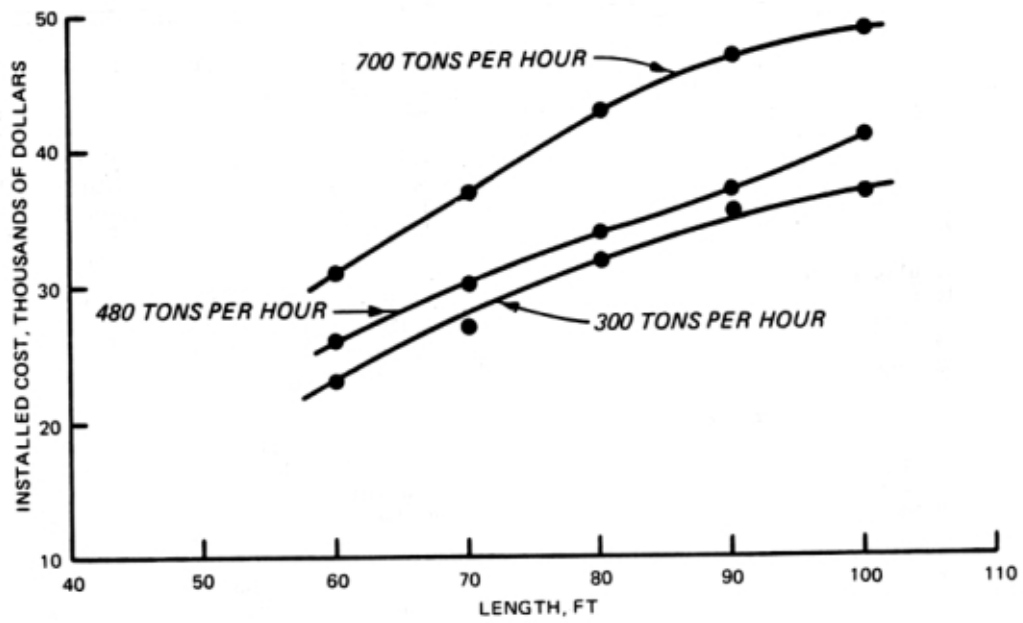

Figure B-8. Installed portable conveyor system costs.

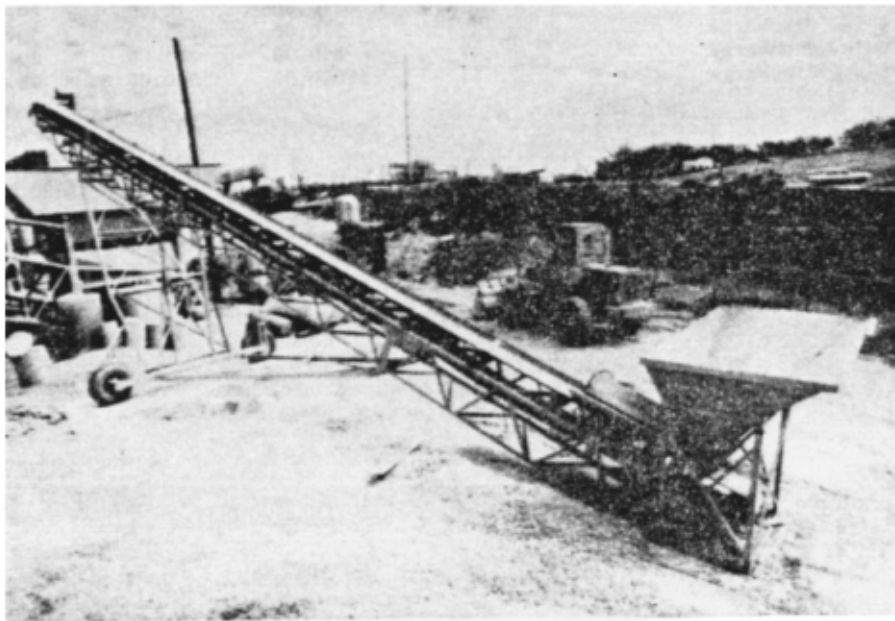

Figure B-9. Typical portable conveyor system (Courtesy The Vince Hagen Company).

B.3 Materials Mixing Equipment

Materials mixing equipment is used to blend reagents with the waste materials to accomplish the solidification/stabilization reaction.

B.3.1 Construction Equipment

Backhoes, clamshells, and draglines have been applied to the in-situ mixing of solidification/stabilization reagents with waste materials. Since this is not a "normal" use for this equipment, little detailed information is available concerning production rates and control of the mixing process (i.e., is mixing adequate or do pockets of unreacted waste material remain?). Backhoe mixing has been successfully applied at Resource Conservation and Recovery Act (RCRA) disposal sites; however, this is usually done in relatively small basins and the solidified/stabilized material is always re-handled. Thus adequate mixing is usually ensured.

The high-speed rotary mixer (Figure B-10) has been used to mix solidification/stabilization reagents with sludges and contaminated soils. The procedure for using this equipment places alternating layers of waste and treatment reagents. Data for application to the solidification/stabilization of waste materials are not available; however, based on highway construction experience, it is estimated that around 2,000 sq m (21,520 sq ft or about 1/2 acre) of surface per day could be mixed. Assuming a lift of 25 cm, 500 cu m/day of waste material could be mixed with the required reagents.

A variety of mixing and other types of materials handling equipment is available from the concrete and roadway materials industry. Products that can be readily adapted to the solidification/stabilization of hazardous wastes include materials storage, batching, and mixing equipment. Mobile, portable, and stationary equipment modules are readily available for all of these functions. Modules can be purchased and assembled to meet site-specific requirements. Equipment manufacturers provide consultative service to address specific materials handling requirements.

A typical adaptation of concrete technology is the use of a base stabilization plant for treating contaminated soils as illustrated in Figure B-11. Sizes for such plants range from 100 to 400 tons/hr and consist of materials storage, batching, and mixing facilities. Materials mixing is generally accomplished using a pug mill. The estimated cost of a base stabilization plant is illustrated in Figure B-12.

Other applications from concrete mixing technology include the use of concrete batch plants, central mixing facilities, and/or transit mixing trucks. These can be used for both apportioning and mixing solidification/stabilization reagents with the waste materials being treated. The costs of both mobile and modular batching plants are illustrated in Figure B-13.



Figure B-10. Typical high-speed rotary mixer (Courtesy Albert H. Half Associates).



Figure B-11. Typical base stabilization plant.

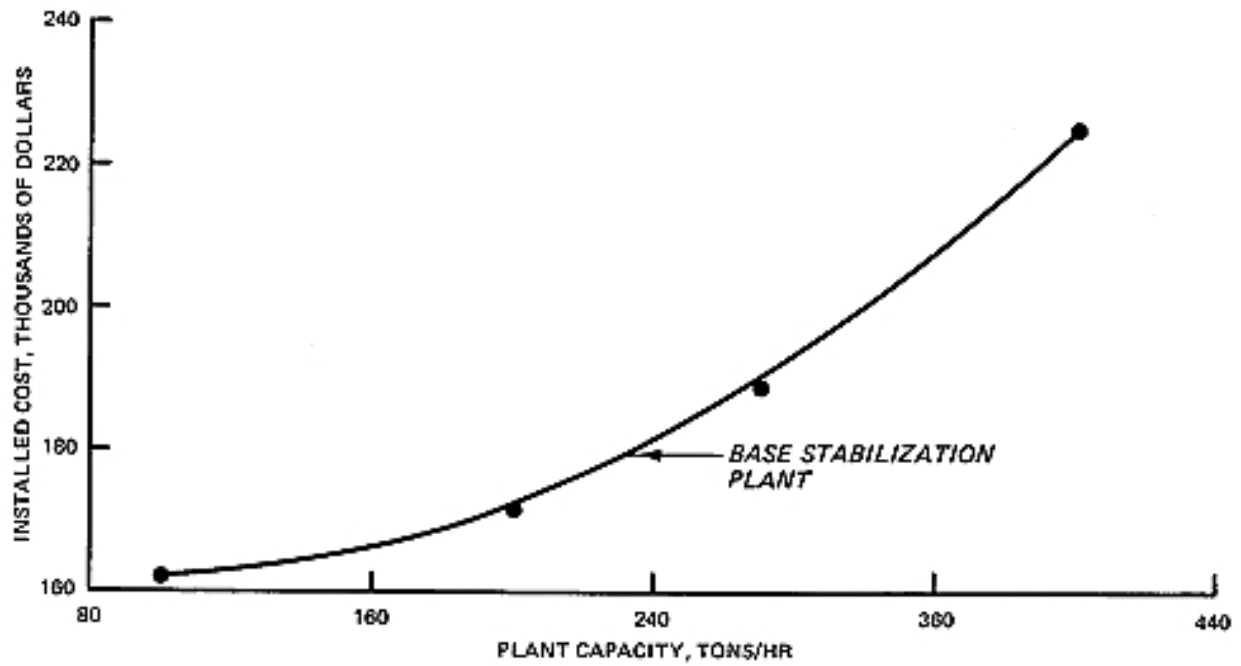

Figure B-12. Installed cost for base stabilization plant.

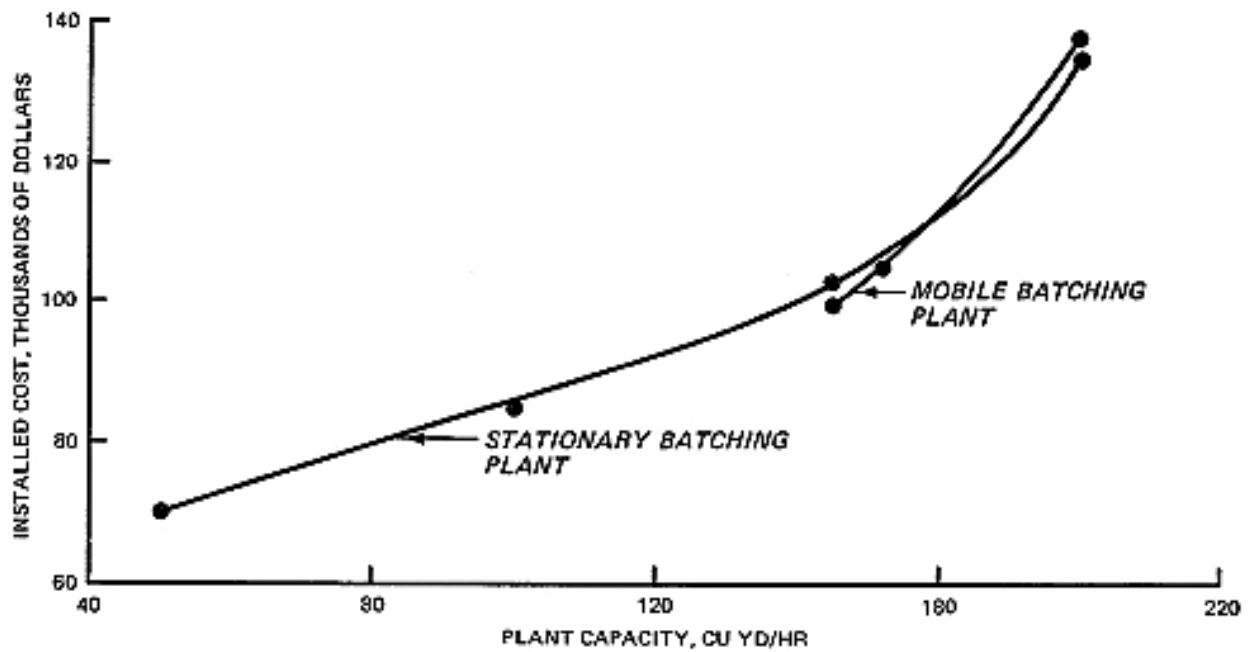

Figure B-13. Installed cost for mobile and modular concrete batching facility.

Materials mixing can be accomplished by central mixing equipment (tilting mixers) or in transit-mix trucks. Tilting mixers are available in sizes ranging from 6 to 12 cu yd per batch. The installed cost of a tilting mixer is presented in Figure B-14.

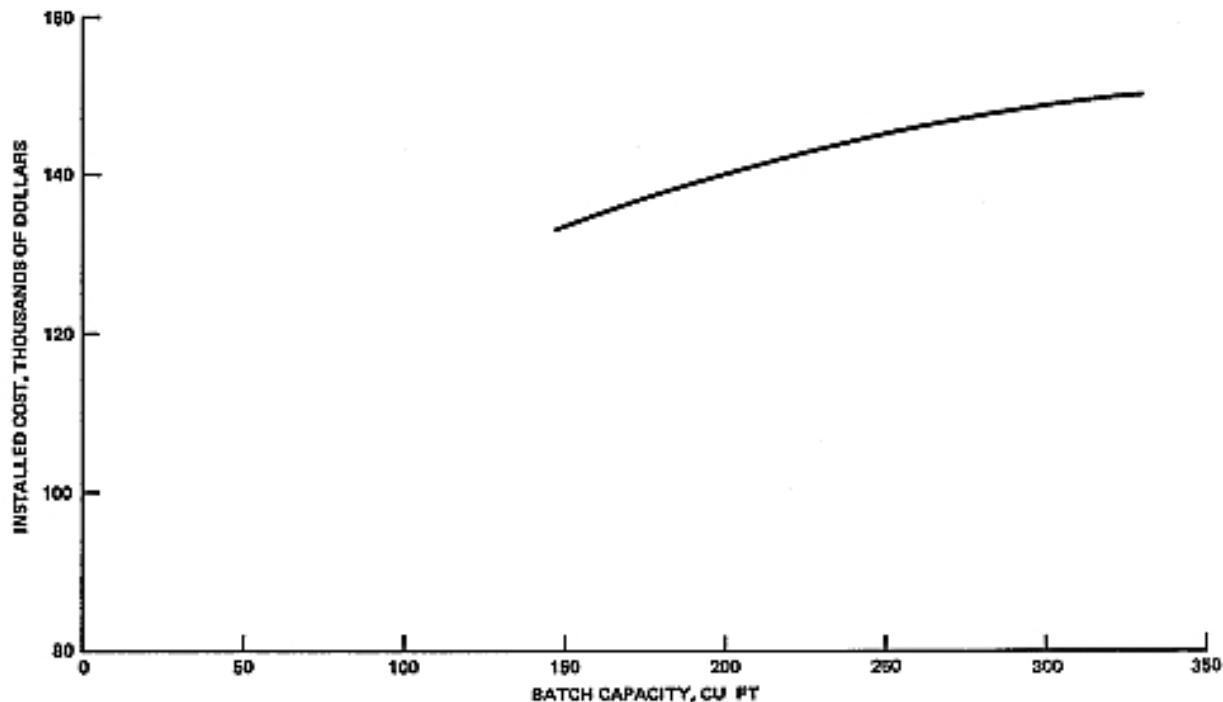

Figure B-14. Installed cost for concrete tilting mixers.

Transit-mix trucks have been used to mix contaminated materials and solidification/stabilization reagents. Typically, the materials are batched in a mobile batch plant and mixed during transport to the final disposal area. Transit-mix trucks are available in capacities ranging from 6 to 12 cu m.

Although the concept for using modified equipment from the concrete industry has been developed, the equipment has not received widespread use because of the relatively high cost compared with equipment used in the scenarios developed in Sections 6.3 through 6.6 of this handbook. However, the use of concrete industry equipment should be included in alternative evaluations on a site-specific basis.

B.3.2 Process Mixing Equipment

A wide variety of process mixing equipment has been used, or is theoretically available for use in the mixing of reagents with waste materials to be solidified or stabilized. This equipment has been adapted from either the food or chemical processing industry. Basic parameters, which include mixing

characteristics, available sizes, and costs for the more significant mixer types, are presented below. Additional information on the specific application of each is provided in Section 6.

The scientific design of mixing equipment is complex and usually requires detailed engineering study. Perry (1973) identifies properties of the materials to be mixed that affect the selection of appropriate mixing equipment: particle-size distribution; bulk density; true density; particle shape; surface characteristics; friability; state of agglomeration; moisture or liquid content of solids; density, viscosity, and surface tension; and temperature characteristics. Little if any scientific design has been applied to mixing required for solidification/stabilization processes. Most mixing equipment has been developed or modified by trial and error based on field experience. One reason for this is the wide range of materials that the typical system may be required to handle. The major types of mixing equipment for waste processing include the change-can mixer, ribbon blender, muller mixer, rotor mixer, and propeller mixer. Detailed engineering has not been performed to optimize the design of mixing equipment currently used for solidification/stabilization of hazardous waste.

B.3.2.1 Change-Can Mixer

The change-can mixer is a vertical batch mixer in which the container is separate from the frame of the machine. Capacities ranging from 0.5 gal to 1,100 gal are available. The most common size used in the solidification of hazardous wastes is the 200-gal drum. Figure B-15 illustrates a typical change-can mixer.

The change-can mixer is ideally suited for use in drum solidification/stabilization of wastes. The mixing head may be raised from the can (drum) allowing the mixing blades to drain into the drum. If necessary, the blades may be wiped down or cleaned by rotating them in a solvent. When the can is removed, cleaning the blades and support is a rather simple process.

Mixing of can contents is achieved in one of two ways. First, the mixing unit assembly may rotate with a planetary motion so that the rotating blades sweep the entire circumference of the can. Second, the can is mounted on a rotating turntable so that all parts of the can will pass fixed scraper blades on the agitation blades at a point of minimum clearance. The mixing action is primarily in the horizontal, to and from the center of the can. Vertical mixing results from the shape of the blades.

As mixing progresses, the flow characteristics usually change. In order to achieve a minimum time cycle, variable speed or two-speed mixers are desirable. A slow speed at the start of mixing will reduce dusting or splashing.

The estimated costs for a change-can mixer installation are presented in Figure B-16.

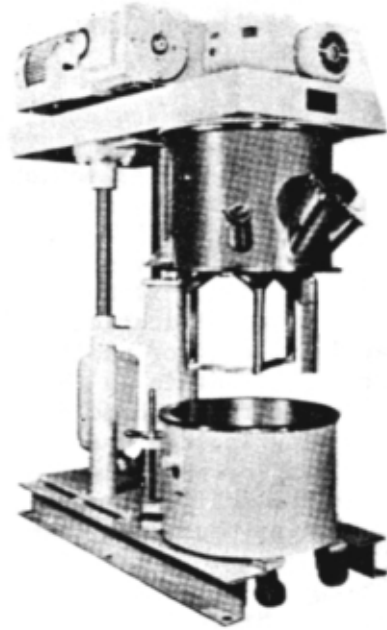

Figure B-15. Typical change-can mixer (Courtesy Charles Ross & Son).

B.3.2.2 Ribbon Blender

A ribbon blender consists of a stationary shell and rotating horizontal mixing elements (Figure B-17). To accommodate a wide variety of materials, it is possible to modify such features as ribbon cross section, ribbon pitch, the number of ribbons, and the clearance between ribbons and ribbons and shell. The ribbon blender can be used for continuous or batch operations. Installed costs for ribbon blenders of various sizes are presented in Figure B-18.

B.3.2.3 Muller Mixer

The muller mixer consists of a stationary pan with rotating wheels and plows (Figure B-19). The muller is typically used for batch operations; however, continuous-operation mullers are available. Installed cost for muller mixing systems are presented in Figure B-20.

B.3.2.4 Rotor Mixers

Rotor mixers consist of shafts with paddles or screws contained in a stationary trough. These mixers may be equipped with single or twin shaft

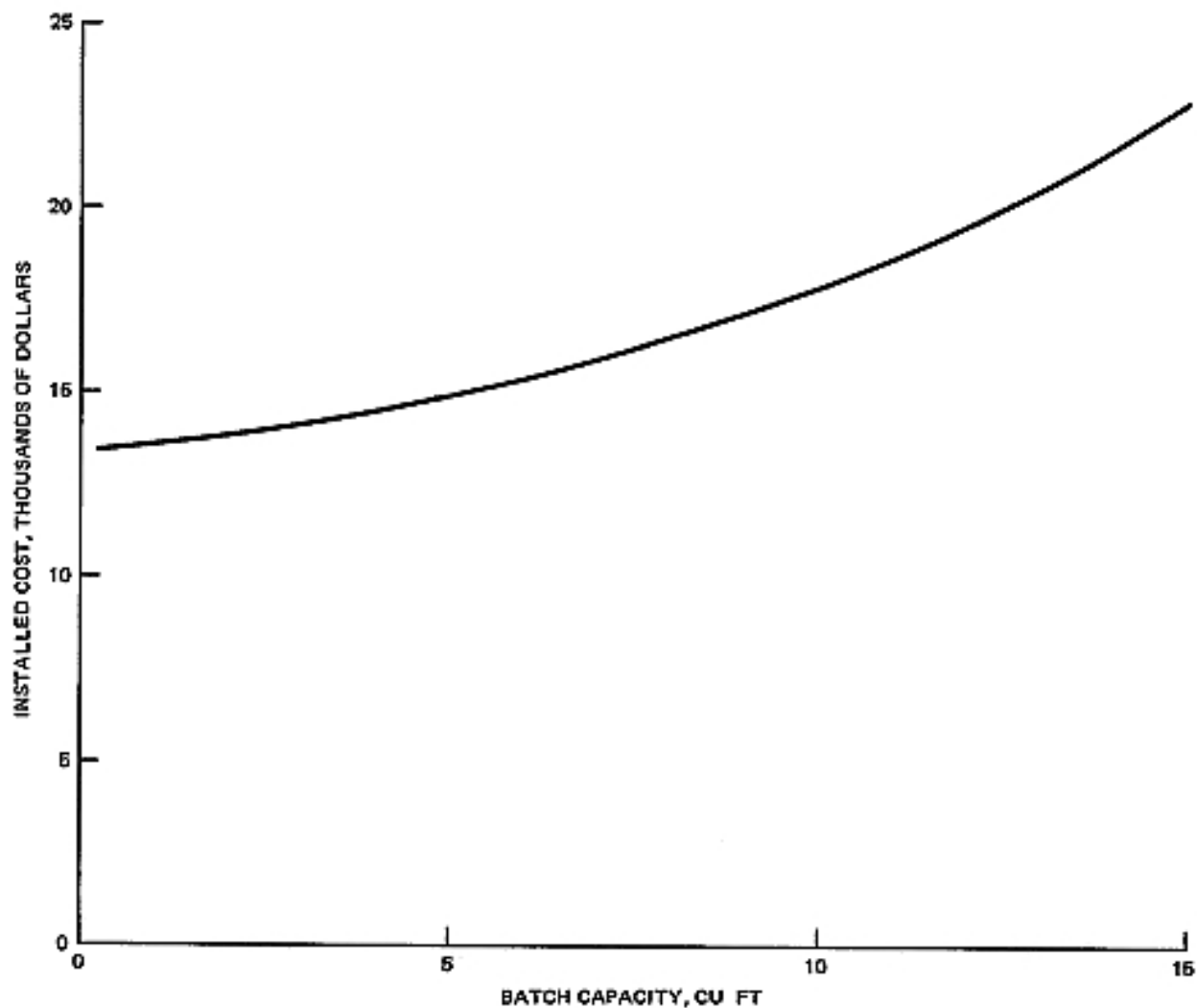

Figure B-16. Installed cost for change-can mixers.

assemblies. Figure B-21 illustrates a twin-shaft rotor mixer. The installed cost for a twin-shaft rotor mixer is presented in Figure B-22.

B.3.2.5 Propeller Mixer

The top-entering propeller mixer consists of a driver, shaft, and propeller. This mixer is lightweight and highly portable, and it can be easily changed from one drum to the next. This mixer works by changing the mixer from drum to drum rather than by changing drums in the mixer. The mixer is mounted on the drum with a clamp or special head frame. Typical cost of the equipment is approximately \$2,000.00. Figure B-23 illustrates a typical propeller mixer.

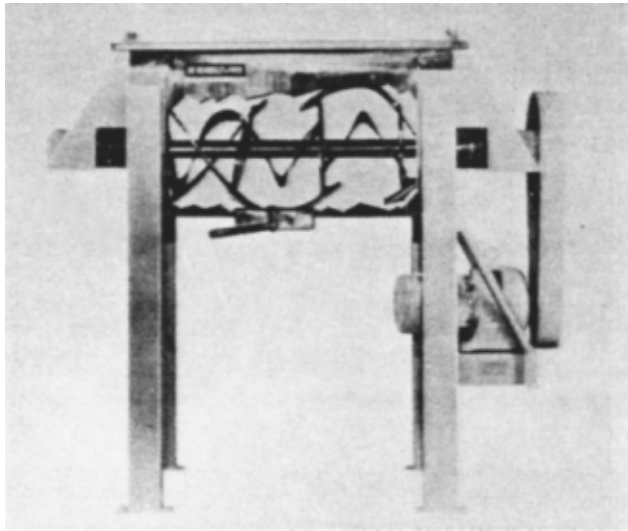

Figure B-17. Typical ribbon blender
(Courtesy Beardsley & Piper).

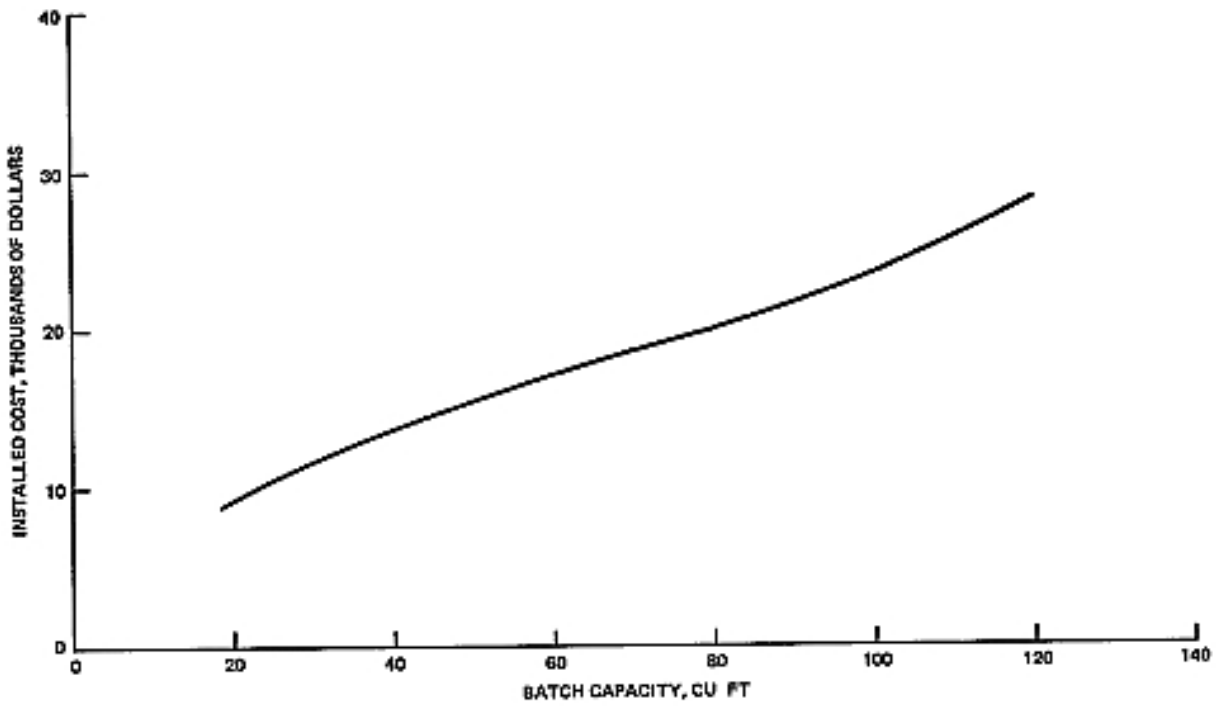

Figure B-18. Installed cost for ribbon blenders.

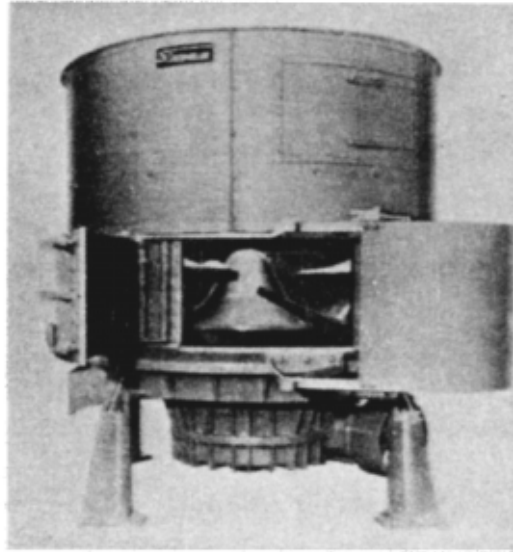

Figure B-19. Typical muller mixer
(Courtesy Beardsley & Piper).

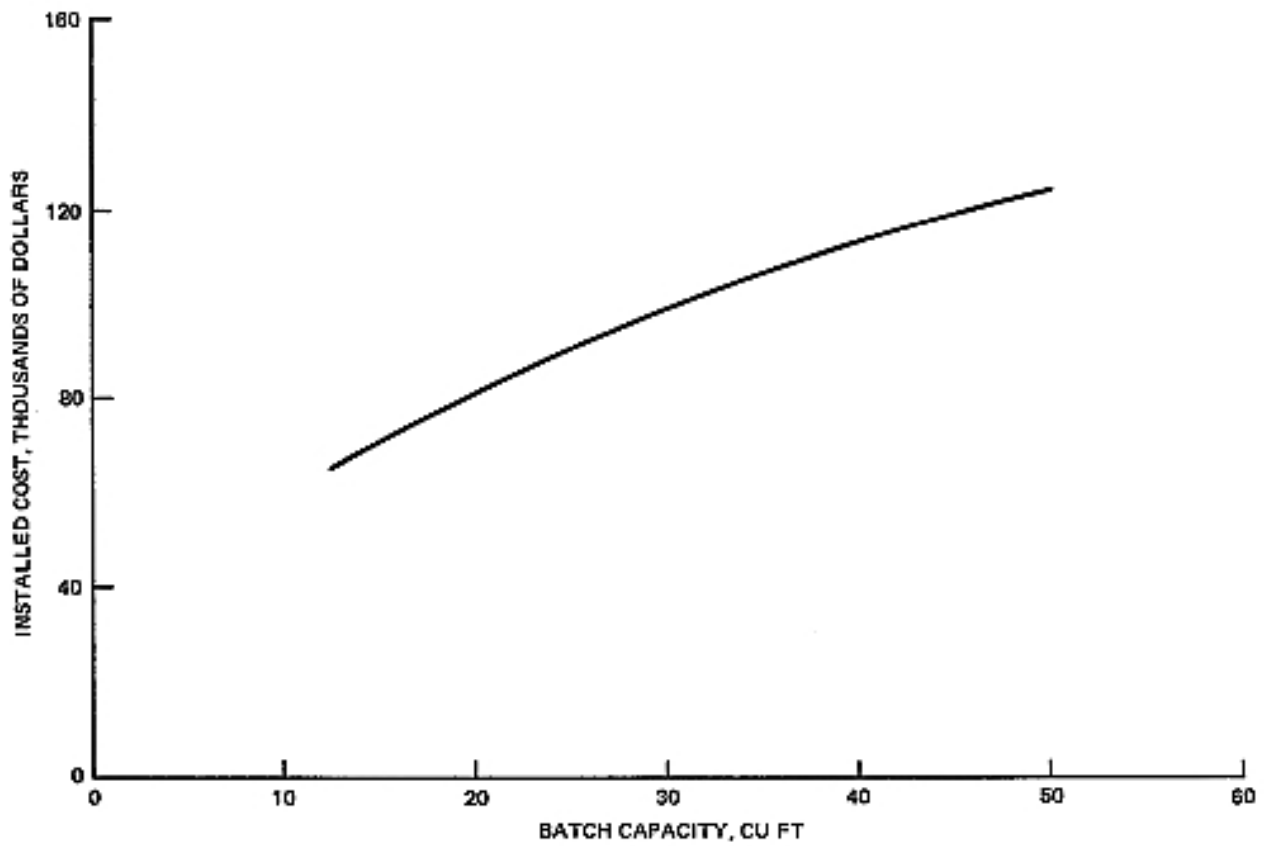

Figure B-20. Installed cost for muller mixers.

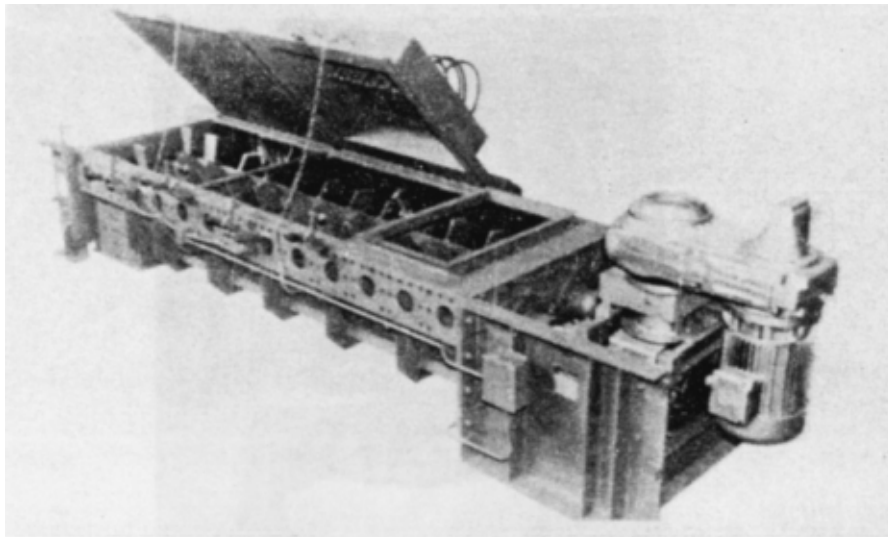

Figure B-21. Typical twin-shaft rotor mixer (Courtesy Beardsley & Piper).

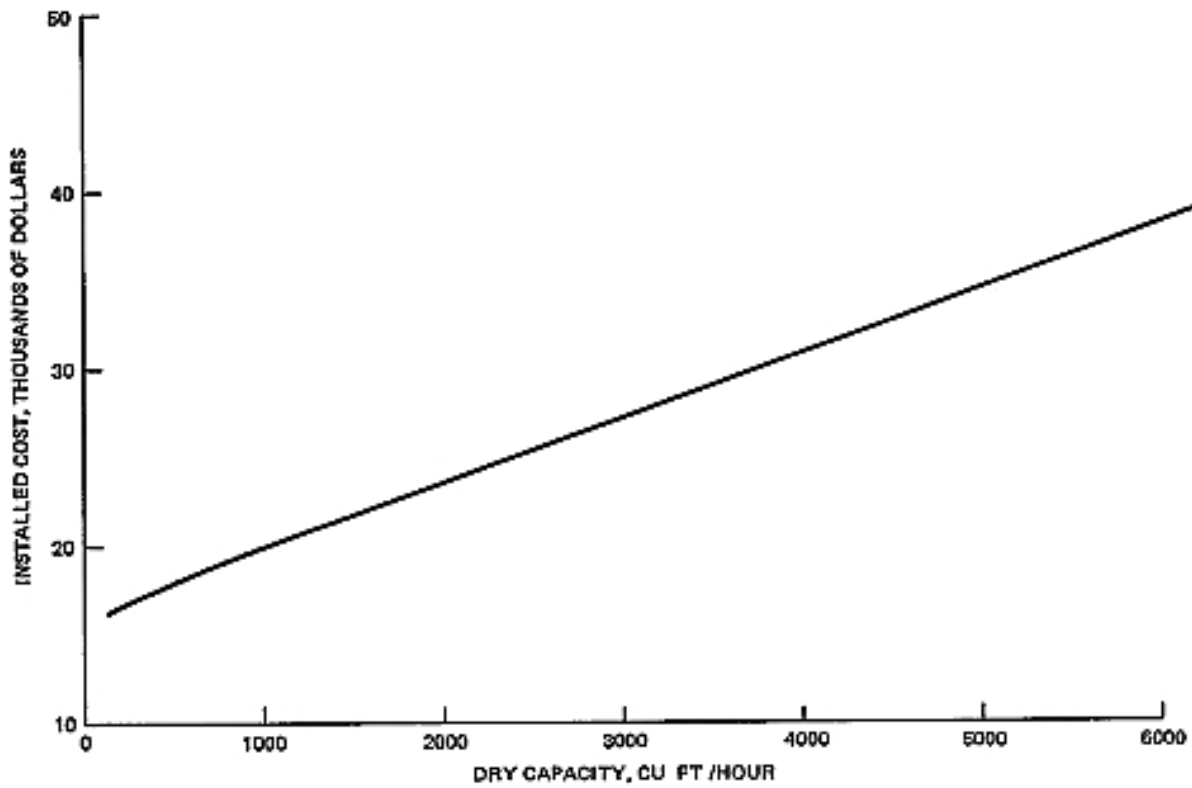

Figure B-22. Installed cost for rotor mixers.

Figure B-23. Typical top-entering propeller mixer (Courtesy Mixing Equipment).



B.4 Materials Control Equipment

Solidification/stabilization processes require the addition of reagents to waste materials in fixed, measured quantities, generally as determined from pilot- or laboratory-scale studies. Adjustments are subsequently made as a result of onsite experience with the particular waste being treated. The control of materials, both the waste to be treated and the reagents to be added, can be accomplished using methods based on either weight or volume. In addition, either batch or continuous control systems are available. The sophistication of the materials control technique selected for a particular project can vary from simplistic systems incorporating manual feed to complex, fully automated equipment.

Materials control (i.e., the proper proportioning of waste materials and solidification/stabilization reagents) is one key to the proper performance of the treated waste materials. Numerous materials control systems are available off-the-shelf. The most common types of equipment used for materials control purposes are discussed below.

B.4.1 Waste Materials Control

Waste materials control can be accomplished by either volume- or weight-based methods. The type of control system selected will depend on the

materials handling equipment and the materials mixing equipment selected to accomplish the solidification/stabilization process.

If the waste material is pumped and a continuous mixer is used, pump curves can be consulted to determine the discharge under stated conditions. Since manufacturers' pump curves are based on pumping clean water and the typical remedial action project will handle sludges or high solids content liquids, adjustment to the manufacturers' curves will be required. Calibration of pumps under field conditions may be required. For those systems using pumps for waste material handling and batch-type mixing equipment, a volumetric batching system can be employed. This system may consist of a separate, level-controlled batch hopper, or the mixing vessel can simply be filled to a predetermined level. Manual or automatic control can be used.

If the waste material is handled by construction equipment, material control can be accomplished by volumetric measurement, or for granular material, aggregate weigh batches from the concrete batch plant industry can be used. Figure B-24 illustrates a weigh batcher being used to meter waste materials. Volumetric measurements can be used in the same manner as for pumped wastes; however, feeding the measuring or mixing equipment will be more difficult. A less sophisticated method of measurement is merely to count the number of truckloads of material and make an estimate of the volume of waste material on each based on the known truck capacity.

Figure B-24. Weigh batcher system for waste materials control (Courtesy Solid Tek).

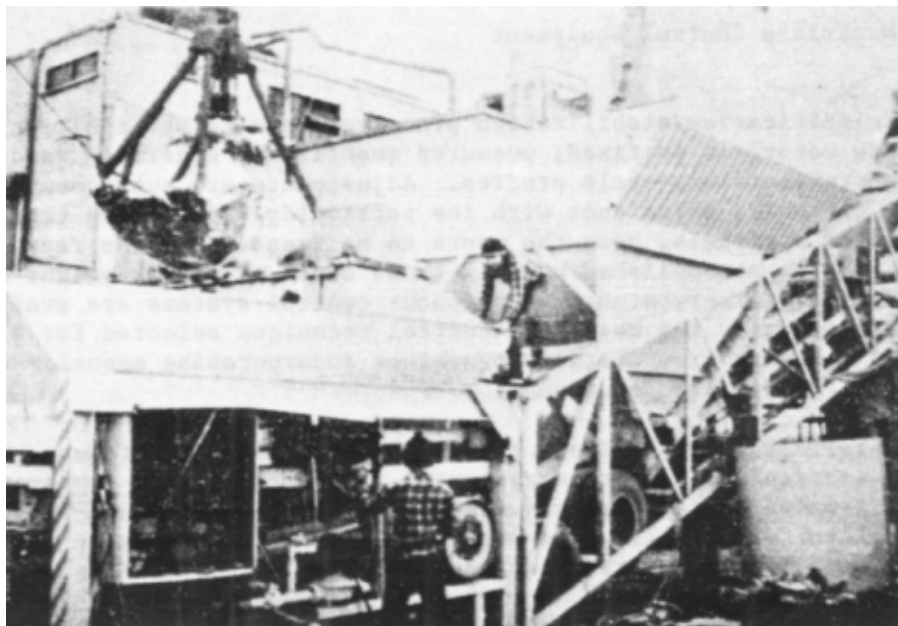

B.4.2 Solid Reagent Control

The control of solid reagents can be accomplished by either volumetric- or weight-based methods. The type of equipment selected should be based on the quantity of material to be fed to the waste and the solidification/stabilization scenario selected.

The most common type of system for feeding dry solids is the screw feeder (Figure B-25). The screw-type feeder is fairly rugged and well suited for application in the field environment. The feed rate is controlled by increasing or decreasing the speed of the screw. Assuming a constant bulk density of material, the weight of material discharged from the screw feeder can be accurately controlled. Screw feeders can be adapted for use with both batch and continuous mixing systems.

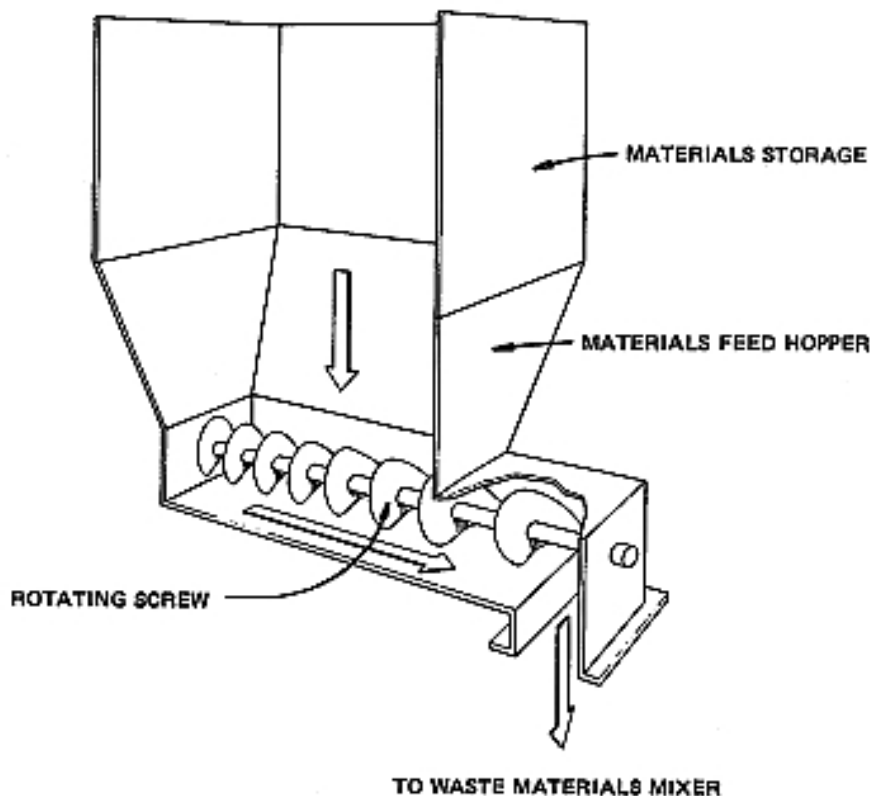

Figure B-25. Typical screw feeder.

Batch and continuous-feed systems based on measurement of weight are also available. These systems, although somewhat more delicate than screw feeder systems, provide for more accurate materials control. Batch weighing systems suitable for use with batch mixing systems usually consist of a containment vessel or hopper mounted on a scale or load cell. The entire assembly is usually mounted directly above the mixing unit. The material being weighed is fed from a storage bin into the hopper. The flow of material is controlled by signals from the load cell or scale. When the set point is

reached, the flow of material is stopped and the batch is ready for addition to the mixer. Weighing accuracies within $\pm 0.25\%$ are available from batch weighing systems. Figure B-26 illustrates a typical weigh feeder system.

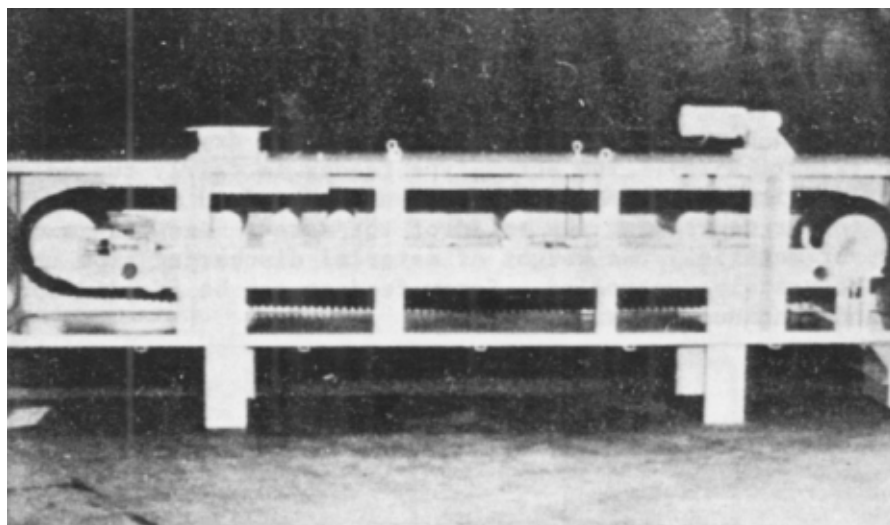

Figure B-26. Typical weigh feeder system (Courtesy Rexnord).

Continuous weighing involves a system that is sensitive to changes in the weight of material on a continuous belt (Figure B-27). Typically, the belt passes a weight-sensitive area (usually load cells) that measure and total the weight of materials on the belt. A control signal is sent to a gate controlling the flow of materials from a storage hopper to the belt. Accuracies within $\pm 1.0\%$ are available from continuous weighing feeders.

B.4.3 Liquid Reagent Control

The control of liquid reagents is normally accomplished by volumetric methods. Typically, liquid reagents will be proportioned with metering pumps or flow-measuring systems sending a signal to a control valve. A popular installation would include a turbine flow meter transmitter with output signal sent to digital or analog instruments for feed rate indication, totaling, and flow control. Numerous other flow-measuring devices are also available, including venturi meters, magnetic flow meters, orifice meters, etc. The turbine flow meter seems, however, to offer greater sensitivity and control.

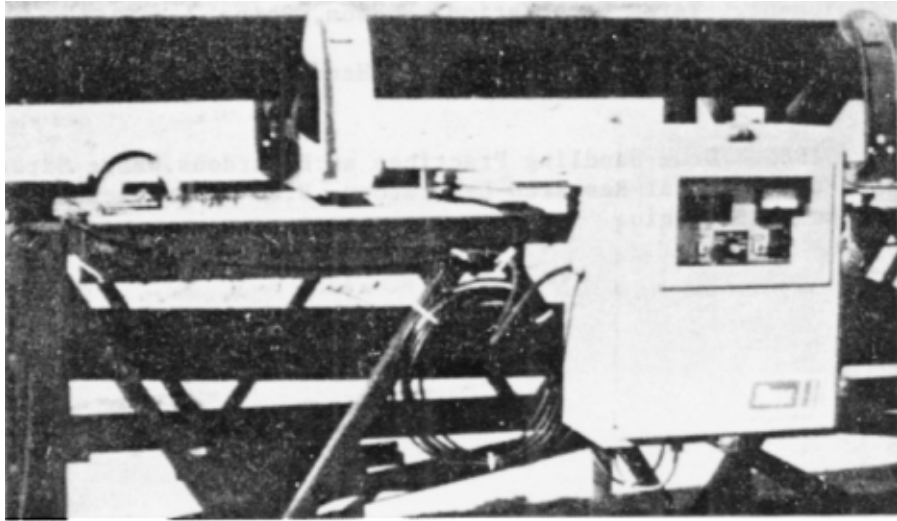

Figure B-27. Typical belt scale system (Courtesy Rexnord).

REFERENCES

- Caterpillar Tractor Co. 1981. Handbook of Earthmoving. Caterpillar Tractor Co., Peoria, Illinois.
- Caterpillar Tractor Co. 1982. Caterpillar Performance Handbook. Caterpillar Tractor Co., Peoria, Illinois.
- Hicks, T. G., and T. W. Edwards. 1971. Pump Application Engineering. McGraw-Hill Book Company, New York, New York.
- Terex. 1981. Production and Cost Estimating of Material Movement with Earthmoving Equipment. Terex Corporation, Hudson, Ohio.
- Perry, R. H. 1973. Chemical Engineers' Handbook. McGraw-Hill Book Co., New York, New York.
- U.S. EPA. 1985. Drum Handling Practices at Hazardous Waste Sites (Draft). Municipal Environmental Research Laboratory, U.S. Environmental Protection Agency, Cincinnati, Ohio.

INDEX

- Absorbent, 2-1, 2-3
- Activated Alumina, 2-8
- Activated Carbon, 2-8
- Anhydrous Sodium Silicate, 6-7, 6-14, 6-26, 6-28, 6-35, A-2
- Area Mixing Alternative, 6-31
- Asphalt, 2-1, 2-16
- Attapulgate, 2-12
- Atterberg Limits, 3-1, 3-3
- Bearing Capacity, 4-8
- Bentonite, 2-6
- Biodegradation, 4-2
- Blender, Ribbon, 2-9, 2-12, 6-20, B-20
- Borate Salts, 2-16
- Bottom Ash, 2-5
- Bulk Density, 3-1, 3-3
- CERCLA, 1-4
- Calcite, 2-6
- Capping of Solidified Wastes, 8-2
- Celite, 2-3
- Cellulosic Sorbents, 2-14
- Chabazite, 2-6
- Chelating Agents, 2-16
- Chemical Binding, 2-5
- Chemical Characterization, 3-4
 - Scavenging, 2-22
 - Storage Facilities, B-1
- Chemsorption, 2-4
- Clay, 2-2, 2-22
- Cleanup of Equipment, 8-1
- Closure, 8-1
- Compatibility, 2-5, 4-7
- Compressive Strength, 3-1, 3-4, 4-7, 7-2
- Cone Index, 3-1, 3-3
- Construction Equipment, B-7, B-15
- Conveyor Equipment, B-11
- Corrosivity, 1-3, 4-1
- Cost Analysis and Comparison, 6-2, 6-36, A-2
- Costs Alternative Reagents, 6-39
 - Area Mixing, 6-34
 - Equipment Leasing, B-12, B-13
 - In-Drum Mixing, 6-5
 - In-Situ Mixing, 6-12
 - Layering, 6-34
 - Labor, 6-3, 6-5, 6-7, 6-14, 6-26, 6-28, 6-35, 6-37
 - Mobile Plant Mixing, 6-25
 - Modular Mixing Plant 6-28, 6-29

Overhead and Profit, 6-5, 6-7, 6-8,
 6-14, 6-26, 6-28, 6-35, 6-37
 Reagent Prices, A-1

Decontamination, 7-6

Delisting, 2-1

Density, 4-7

Dewatering, 2-23

Diadochy, 2-4

Diatomaceous Earth, 2-10

Drum Handling Equipment, B-11

Drum-Over-Packs, 2-18

Dry Chemical Storage, B-2

Durability, 4-9, 4-10

Dust, 7-5

Elemental Sulfur, 2-16

Emulsifiers, 2-14

Environmental Concerns, 7-2

Expanded Mica, 2-3

Extraction Procedure (EP), 2-1,
 4-1

Feldspar, 2-6

Filtering, 3-1

Fixation, Definition, 1-1

Flammability, 1-3, 4-1

Flowability, 3-2, 5-2

Floccing, 3-1

Fly ash, 1-2, 2-2, 2-5, 2-6,
 5-2, B-2

Free Liquid, 2-2, 2-5, 4-2, 4-5,
 4-10

Freeze-thaw Test, 4-3, 4-9

Fumes, 5-2

Glassification, 2-2

Grain-Size Distribution, 3-1, 3-3

Ground Brick, 2-10

Ground Water, 4-2

Gypsum, 2-6, B-2

Heavy Metal Wastes and Sludges,
 2-11, 2-16, 2-23

Hematite, 2-6

Heulandite, 2-6

Hydrated Silica Gel, 2-12

Ignitability, 1-3, 4-2, 4-5, 4-6,
 4-10

Illite, 2-6, 2-7

In-Drum Mixing Alternative, 6-3

In-Situ Mixing Alternative, 6-10

Interference, 2-11

Ion Exchange Resins, 2-1, 2-22

Kaolinite, 2-6, 2-7

Kiln Dust, 2-2, 2-5, 2-6, 6-13,
 B-2

Laumonite, 2-6

Layering, See Area Mixing
 Alternative

Leachability, 1-3, 4-3, 4-10

Lime, 1-2, B-2

Lime-Fly Ash Pozzolan, 2-3
 Liquid Chemical Storage, B-4
 Macroencapsulation, 1-1, 2-3, 2-17
 Microencapsulation, 1-1, 2-1, 2-4
 2-15, 2-19
 Mixer, Change-Can, 6-5, B-19
 Construction Equipment, B-15
 Muller, B-20
 Propeller, 6-5, 6-6, B-21
 Ribbon, See Blender, Ribbon
 Rotor, 6-20, B-15, B-20
 Mobile Plant Mixing Alternative,
 6-18, 6-19, 6-21
 Modular Plant Mixing Alternative,
 6-23, 6-24, 6-27
 Monofill, 1-1
 Monolith, 1-1, 2-1
 Mullite, 2-6
 National Contingency Plan, 1-4
 Native soil, 2-2
 Neutralization, 2-1, 2-20
 OSHA Regulations, 6-9, 7-3, 7-4
 Oil Sludge, 2-5, 2-9, 2-11, 2-13
 Oil and Grease, 2-11, 3-4
 Onsite Chemical Handling, A-3
 Organic Polymers, 2-1, 2-2
 Organic Vapor and Dust
 Generation, 7-5
 Oxidation/Reduction, 2-22
 pH, 2-20, 2-22
 Particle-Size Distribution, 4-7
 Passivation, 2-4
 Percent Moisture, 3-1
 Permeability, 4-7, 4-9, 4-10
 Personnel Protection Program, 7-3
 Phenol, 2-23
 Pilot Studies, 5-2, 5-3
 Polyethylene, 2-2, 2-16, 2-18
 Portland Cement, 2-2, 2-3, 2-10,
 2-12, 2-13, B-2
 Polypropylene, 2-16
 Pozzolan, 2-2, 2-10, 2-12, 2-13
 Pozzolan-Portland cement, 2-2,
 2-3, 2-12, 2-13, 3-4
 Pretreatment Techniques, 2-20
 Pumpability, 3-2, 5-2
 Pumps, B-6
 Quality Control, 5-1, 6-30, 7-1
 Resource Conservation and
 Recovery Act, 1-4, 4-1, 6-17
 Radioactive Waste, 2-1
 Reactivity, 1-3, 4-1, 4-5, 4-6,
 4-10
 Redox Potential, 2-9
 Reprecipitation, 2-4
 Safety Concerns, 5-1, 6-9, 6-17,
 6-29, 6-34, 7-3
 Sampling of Treated Wastes, 7-1
 Screw-Extruder, 2-17
 Screw Feeder, B-27

Self-Cementation, 2-2, 2-10
 Settling, 3-1
 Shear Strength, 3-4
 Silica, 2-3, 2-22
 Site Monitoring, 8-1
 Smectite, 2-6
 Soil-cement, 4-9
 Solidification, Definition, 1-1
 Solubilities, Metal Hydroxides,
 2-21
 Soluble Silicates, 2-3
 Sorption, 2-3, 2-5
 Specifications, 4-19
 Spill Control, 7-7
 Stability, Physical, 4-7
 Biological, 4-8
 Stabilization, Definition, 1-1
 Stilbite, 2-6
 Storage, B-2, B-3
 Superfund, 1-4
 Surfactants, 2-14
 Suspended Solids, 3-1, 3-2
 Testing of Treated Wastes, 7-2
 Thermoplastic Microencapsulation,
 2-3, 2-15, 2-19
 Toluene, 2-16
 Trafficability, 3-3
 Transportation Costs, 6-1
 Unconfined and Compressive
 Strength, 3-1, 3-4, 4-7
 Vermiculite, 2-6, 2-7
 Waste Blending, 2-23
 Wax, 2-16
 Wet-dry Test, 4-3, 4-9
 Xylene, 2-16
 Zeolites, 2-1, 2-3, 2-6, 2-7, 2-14

United States
Environmental Protection
Agency

Center for Environmental Research
Information
Cincinnati OH 45268

BULK RATE
POSTAGE & FEES PAID
EPA
PERMIT No. G-35

Official Business
Penalty for Private Use, \$300

Please make all necessary changes on the above label,
detach or copy, and return to the address in the upper
left-hand corner.

If you do not wish to receive these reports CHECK HERE
detach, or copy this cover, and return to the address in the
upper left-hand corner.

EPA/540/2-86/001