

FINAL REPORT

Contaminant Flux Reduction Barriers for Managing Difficult-to-Treat Source Zones in Unconsolidated Media

ESTCP Project ER-201328

JUNE 2017

Elaine A. Higgins
Poonam R. Kulkarni
Charles J. Newell
Brian A. Strasters
GSI Environmental Inc.

Distribution Statement A
This document has been cleared for public release



Page Intentionally Left Blank

This report was prepared under contract to the Department of Defense Environmental Security Technology Certification Program (ESTCP). The publication of this report does not indicate endorsement by the Department of Defense, nor should the contents be construed as reflecting the official policy or position of the Department of Defense. Reference herein to any specific commercial product, process, or service by trade name, trademark, manufacturer, or otherwise, does not necessarily constitute or imply its endorsement, recommendation, or favoring by the Department of Defense.

Page Intentionally Left Blank

REPORT DOCUMENTATION PAGE

Form Approved
OMB No. 0704-0188

Public reporting burden for this collection of information is estimated to average 1 hour per response, including the time for reviewing instructions, searching existing data sources, gathering and maintaining the data needed, and completing and reviewing this collection of information. Send comments regarding this burden estimate or any other aspect of this collection of information, including suggestions for reducing this burden to Department of Defense, Washington Headquarters Services, Directorate for Information Operations and Reports (0704-0188), 1215 Jefferson Davis Highway, Suite 1204, Arlington, VA 22202-4302. Respondents should be aware that notwithstanding any other provision of law, no person shall be subject to any penalty for failing to comply with a collection of information if it does not display a currently valid OMB control number. **PLEASE DO NOT RETURN YOUR FORM TO THE ABOVE ADDRESS.**

1. REPORT DATE (DD-MM-YYYY) 20/06/2017		2. REPORT TYPE Final Report		3. DATES COVERED (From - To) Oct 2013 to June 2017	
4. TITLE AND SUBTITLE Final Report: Small-Scale Demonstration, Contaminant Flux Reduction Barriers for Managing Difficult-to-Treat Source Zones in Unconsolidated Media				5a. CONTRACT NUMBER	
				5b. GRANT NUMBER	
				5c. PROGRAM ELEMENT NUMBER	
6. AUTHOR(S) Poonam R. Kulkarni, Elaine A. Higgins, Brian A. Strasters, Charles J. Newell				5d. PROJECT NUMBER ER-201328	
				5e. TASK NUMBER	
				5f. WORK UNIT NUMBER	
7. PERFORMING ORGANIZATION NAME(S) AND ADDRESS(ES) GSI Environmental Inc. 2211 Norfolk, Suite 1000 Houston, Texas 77098				8. PERFORMING ORGANIZATION REPORT NUMBER ER-201328	
9. SPONSORING / MONITORING AGENCY NAME(S) AND ADDRESS(ES) Environmental Security and Technology Certification Program 4800 Mark Center Drive, Suite 17D08 Alexandria, VA 22350-3600				10. SPONSOR/MONITOR'S ACRONYM(S) ESTCP	
				11. SPONSOR/MONITOR'S REPORT NUMBER(S) ER-201328	
12. DISTRIBUTION / AVAILABILITY STATEMENT Approved for public release; distribution is unlimited.					
13. SUPPLEMENTARY NOTES					
14. ABSTRACT The overall objective of this project was to evaluate if inexpensive flow reduction agents delivered via permeation grouting technology could help manage difficult-to-treat chlorinated solvent source zones. This approach aims to provide two benefits for improving groundwater quality at chlorinated volatile organic carbon (CVOC) sites by: 1. physically reducing the mass flux of contaminants leaving the source zone by using permeation grouting, thereby reducing risk and making the downgradient plume more amenable for management by natural attenuation processes; and 2) increasing the Natural Source Zone Depletion (NSZD) rate within the source by diverting competing electron acceptors around the source zone to create an enhanced reductive dechlorination zone (ERDZ). This report describes the results of a Small-Scale Demonstration that achieved an average 64% reduction in flow through three small barriers. This was lower than the performance objective of a 90% reduction in flow and was likely caused by the low permeability of the silty sands in the test area. Finally, applications of one acre in area or more are significantly less costly than conventional in-situ remediation technologies (\$996K per acre and \$21 per cubic yard for a one acre site).					
15. SUBJECT TERMS Barrier, ERDZ, NSZD, Chlorinated Solvents, Grouting					
16. SECURITY CLASSIFICATION OF:			17. LIMITATION OF ABSTRACT	18. NUMBER OF PAGES	19a. NAME OF RESPONSIBLE PERSON Charles J. Newell
a. REPORT	b. ABSTRACT	c. THIS PAGE			19b. TELEPHONE NUMBER (include area code) 713-522-6300
				163	

Page Intentionally Left Blank

FINAL REPORT

Project: ER-201328

TABLE OF CONTENTS

	Page
EXECUTIVE SUMMARY	ES-1
1.0 INTRODUCTION.....	1
1.1 BACKGROUND.....	2
1.2 OBJECTIVE OF THE DEMONSTRATION	3
1.3 REGULATORY DRIVERS.....	3
2.0 TECHNOLOGY.....	5
2.1 TECHNOLOGY DESCRIPTION.....	5
2.2 TECHNOLOGY DEVELOPMENT	6
2.3 ADVANTAGES AND LIMITATIONS OF THE TECHNOLOGY.....	6
2.3.1 Advantages of the Technology	6
2.3.2 Limitations of the Technology	7
3.0 PERFORMANCE OBJECTIVES.....	9
3.1 PERFORMANCE OBJECTIVE: EVALUATION OF FLOW REDUCTION MATERIALS	10
3.1.1 Data Requirements	11
3.1.2 Success Criteria	11
3.2 PERFORMANCE OBJECTIVE: DETERMINE COST FACTORS FOR TECHNOLOGY.....	11
3.2.1 Data Requirements	11
3.2.2 Success Criteria	11
3.3 PERFORMANCE OBJECTIVE: EVALUATE REDUCTION OF MASS FLUX AT CHLORINATED SOLVENT SITE.....	11
3.3.1 Data Requirements	11
3.3.2 Success Criteria	11
3.4 PERFORMANCE OBJECTIVE: DETERMINE POTENTIAL FOR ENHANCEMENT OF REDUCTIVE DECHLORINATION PROCESSES	12
3.4.1 Data Requirements	12
3.4.2 Success Criteria	12
3.5 PERFORMANCE OBJECTIVE: EASE OF INSTALLATION.....	12
3.5.1 Data Requirements	12
3.5.2 Success Criteria	12
4.0 SITE DESCRIPTION.....	13
4.1 SITE LOCATION AND HISTORY	13
4.2 SITE GEOLOGY / HYDROGEOLOGY.....	15
4.3 CONTAMINANT DISTRIBUTION	17
5.0 TEST DESIGN.....	19
5.1 CONCEPTUAL EXPERIMENTAL DESIGN	19

TABLE OF CONTENTS (Continued)

	Page
5.1.1 Description of Flux Reduction Materials/Formulations	19
5.1.2 Task 2: Small-Scale Demonstration	22
5.1.3 Task 3: Large-Scale Demonstration	23
5.2 BASELINE CHARACTERIZATION ACTIVITIES	27
5.2.1 Small-Scale Demonstration	27
5.2.2 Large-Scale Demonstration	27
5.3 TREATABILITY OR LABORATORY STUDY RESULTS.....	28
5.4 DESIGN AND LAYOUT OF TECHNOLOGY COMPONENTS.....	29
5.4.1 Injection Skid Design	29
5.4.2 Small-Scale Demonstration	35
5.4.3 Large-Scale Demonstration	37
5.5 FIELD TESTING.....	39
5.5.1 Small-Scale Demonstration	39
6.0 PERFORMANCE ASSESSMENT.....	41
6.1 EVALUATION OF FLOW-REDUCTION MATERIALS	41
6.1.1 Selection of Two Different Flow-Reduction Materials	41
6.1.2 On-Site Gel Tests with Site Soils	41
6.2 INJECTION WELL AND BARRIER CONSTRUCTION.....	41
6.3 EVALUATION OF REDUCTION OF MASS FLUX	44
6.3.1 Results: Before/After Extraction Tests.....	44
6.3.2 Results: Constant-Head Water Injection Test.....	44
7.0 COST ASSESSMENT	49
7.1 FIELD DEMONSTRATION COSTS TRACKED.....	49
7.1.1 Demonstration Study Cost Element: Project Planning and Design.....	49
7.1.2 Demonstration Study Cost Element: Field Program and Performance Assessment.....	49
7.1.3 Demonstration Study Cost Element: Data Evaluation and Reporting.....	49
7.2 COSTS OF FULL-SCALE INSTALLATION OF FLUX REDUCTION BARRIERS	
51	
7.2.1 Estimated Costs at a Hypothetical 1-Acre Site.....	51
7.2.2 Comparison of Flux Reduction Barriers with Other Technologies	53
7.3 COST DRIVERS.....	56
8.0 IMPLEMENTATION ISSUES.....	57
9.0 REFERENCES.....	61
APPENDIX A ENHANCED REDUCTIVE DECHLORINATION ZONE (ERDZ)	
CALCULATION.....	A-1
APPENDIX B SITE GEOLOGY.....	B-1
APPENDIX C SOLUTIONS IES TREATABILITY STUDY	C-1
APPENDIX D RESPONSES TO ESTCP COMMENTS	D-1
APPENDIX E INJECTION SKID DESIGN MANUAL	E-1
APPENDIX F HYDRAULIC CONDUCTIVITY CALCULATIONS SMALL-SCALE	
DEMONSTRATION	F-1
APPENDIX G POINTS OF CONTACT.....	G-1

LIST OF FIGURES

	Page
Figure ES-1: Permeation Grouting Sequence.....	ES-1
Figure ES-2: Enhanced Reductive Dechlorination Zone Concept.....	ES-2
Figure ES-3: Results of Small-Scale Demonstration	ES-3
Figure ES-4: Decision Logic for Applying Barrier Technology at CVOC Sites.....	ES-6
Figure 2.1: Approximate Cost Model for Application to Various Source Zone Areas.....	7
Figure 4.1: Locations of Small-Scale and Large-Scale Demonstration Areas.....	14
Figure 4.2: Plan View of North Plume (top) and Cross-Section A-A' (bottom)	16
Figure 5.1A: Conceptual Layout of Small-Scale Field Demonstration, Plan View (left) and Flux Reduction (right).....	23
Figure 5.2: Large-Scale Field Demonstration, Plan View	24
Figure 5.3A: MODFLOW Groundwater Flow Modeling Showing Streamlines Around 4-Sided Barrier (Top Panel) And Three-Side Barrier With Opening Facing Downstream (Bottom Panel) and Percent Flow Reduction Through Interior of Barrier	25
Figure 5.4: Process Flow Diagram for Chemical Grout Injection Skid	32
Figure 5.5: Process Flow Diagram for Injection Manifold and Tubing	33
Figure 5.6: Injection Skid (Left) and Injection Manifold (Right)	34
Figure 5.7: Conceptual Diagram of Direct Push Multi-Level Injection Wells With Four Separate Injection Zones.....	35
Figure 5.8: Plan View of Multi-Level Injection Well Design.....	36
Figure 5.9: Small-Scale Demonstration Configuration	36
Figure 5.10: Large-Scale Demonstration Injection Points	38
Figure 6.1: On-Site Gel Tests with Site Soils.....	41
Figure 6.2: Location of the Phase 1 Demonstration at Site 17 at the Indian Head NSF	42
Figure 6.3: Injection Skid Assembly with all Components.....	43
Figure 6.4: Well Head Injection Assemblies (Left) and Water Vessels Setup for the Constant-Injection Test.....	46
Figure 6.5: Example AQTESOLV Estimation of Aquifer Parameters for the Constant-Head Injection Test Conducted at the Indian Head NSF.....	47
Figure 6.6: Aquifer Hydraulic Conductivities at Site 17 at Indian Head NSF	47

LIST OF TABLES

	Page
Table 3.1: Performance Objectives of the Small-Scale and Large-Scale Demonstrations	10
Table 5.1: Applicability of Various Water Tightening Grouts vs. Hydraulic Conductivity (Powers et al., 2007).....	20
Table 5.2: Determination of Injection Pressures	30
Table 5.3: Grout Mixtures	31
Table 6.1: Injection Point Construction Details	42
Table 6.2: Grout Volumes Injected per Interval.....	43
Table 6.3: Volume Groundwater Removed During Pre- and Post-Barrier 4-Hour Extraction Tests.....	44
Table 6.4: Aquifer Hydraulic Conductivities With and Without Barrier	45
Table 7.1: Summary of Actual Costs for Field Demonstration.....	50
Table 7.2: Parameters and Assumptions of Implementation at a Hypothetical Site	52
Table 7.3: Estimated Costs of Implementation at a Hypothetical 1-Acre Site.....	53
Table 7.4: Description of Case Study Site.....	53
Table 7.5: Detailed Cost Analysis Comparison between EISB and Flux Reduction Barriers	54
Table 7.6: Cost Comparison of Flux Reduction Barriers with Other Remedial Options	56

ACRONYMS AND ABBREVIATIONS

bgs	Below ground surface
CaCl ₂	Calcium chloride
cis-1,2-DCE	cis-1,2-dichloroethylene
cm	centimeter
cP	centipoise
DBE	dibasic ester
DNAPL	Dense Non-Aqueous Phase Liquid
DoD	Department of Defense
DPT	Direct Push Technology
ERDZ	Enhanced Reductive Dechlorination Zone
ESTCP	Environmental Security Technology Certification Program
EVO	Emulsified vegetable oil
ft	Foot, feet
gal	gallons
gpm	gallons per minute
H ₂ O	Water
HASP	Health and Safety Plan
in	inch
kg	kilogram
L	Liter
m	meters
mg	milligram
MNA	Monitored Natural Attenuation
Msl	Mean sea level
NaSi	Sodium silicate
ND	Non-Detect
NSF	Naval Support Facility
NSZD	Natural Source Zone Depletion (NSZD)
OoM	Order of Magnitude
ORP	Oxidation Reduction Potential
PCE	Tetrachloroethylene

PFM	Passive Flux Meter
PI	Principal Investigator
psi	pounds per square inch
PVC	Polyvinyl chloride
QA	Quality assurance
QC	Quality control
TCE	Trichloroethylene
V%	Percentage by volume
VC	Vinyl chloride
VOC	Volatile organic compound
Wt-%	Percentage by weight
µg	microgram

EXECUTIVE SUMMARY

Project Objective

The overall objective of this project was to evaluate if inexpensive flow reduction agents delivered via permeation grouting technology could help manage difficult-to-treat chlorinated solvent source zones. This approach aims to provide two benefits for improving groundwater quality at chlorinated volatile organic carbon (CVOC) sites by:

1. physically reducing the mass flux of contaminants leaving the source zone by using permeation grouting (Figure ES-1), thereby reducing risk and making the downgradient plume more amenable for management by natural attenuation processes; and
2. increasing the Natural Source Zone Depletion (NSZD) rate within the source by diverting competing electron acceptors (e.g., dissolved oxygen, nitrate, and sulfate) around the source zone to create an enhanced reductive dechlorination zone (ERDZ) (Figure ES-2).

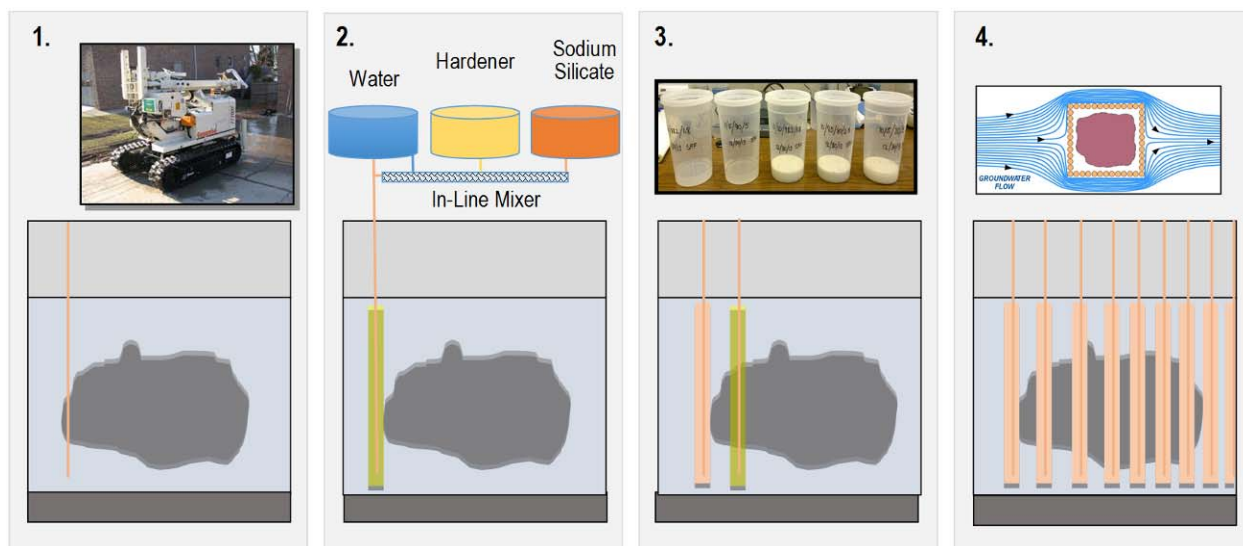

Figure ES-1: Permeation Grouting Sequence

1. A small injection point (either inexpensive single use multi-level well or direct push injection point that injects while pulling up) is driven into source zone. 2. Water, hardener, and silica gel are mixed on the surface and injected as a liquid into the injection point, filling up the pore space of the sands. 3. After 0.5 to 4 hours, the silica gel changes from liquid state to a gel state, greatly reducing the water flow through the sand/gel mix. 4. The process is repeated by drilling and injecting in adjacent injection points (spaced 0.8 to 2 m apart), forming a barrier surrounding the source.

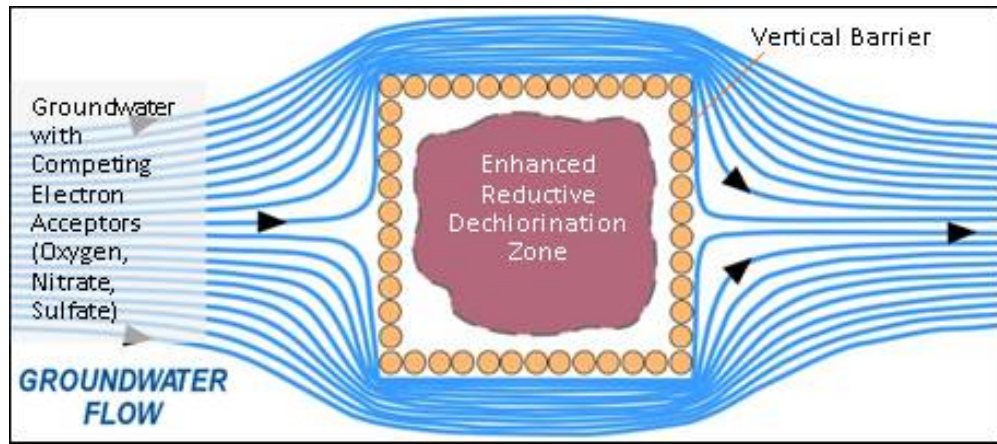

Figure ES-2: Enhanced Reductive Dechlorination Zone Concept

Electron acceptors that flow into a CVOC source zone can consume valuable electron donor. Diverting them can increase the NSZD rate.

Project Outcome

This project generated the following deliverables and conclusions:

- A detailed demonstration of how to design and construct permeation grouting barriers using silica gel type grouts and commonly used remediation technology (direct push rigs and injection skids);
- Instructions on how to estimate the benefits from the electron acceptor diversion (Appendix A);
- A detailed literature review of permeation grouting technology;
- A laboratory study performed by Solutions-IES that describes a novel silica gel/vegetable oil grout that can be used for permeation grouting (Appendix C)
- A Design Manual for how to build a silica gel injection skid (Appendix E).



The project demonstration had these results:

- A description of a Small-Scale Demonstration that achieved **an average 64% reduction** in flow through three small barriers. This was lower than the performance objective of a 90% reduction in flow and was likely caused by the low permeability of the silty sands in the test area.
- A Large Scale Demonstration was not performed due to the low permeability of the planned test area. However, based on standard geotechnical practice, 90% groundwater flow reduction with silica gel permeation grouting is likely achievable at sites with the main transmissive units having hydraulic conductivity closer to the optimal range (from 5×10^{-4} to 10^{-2} cm/sec).

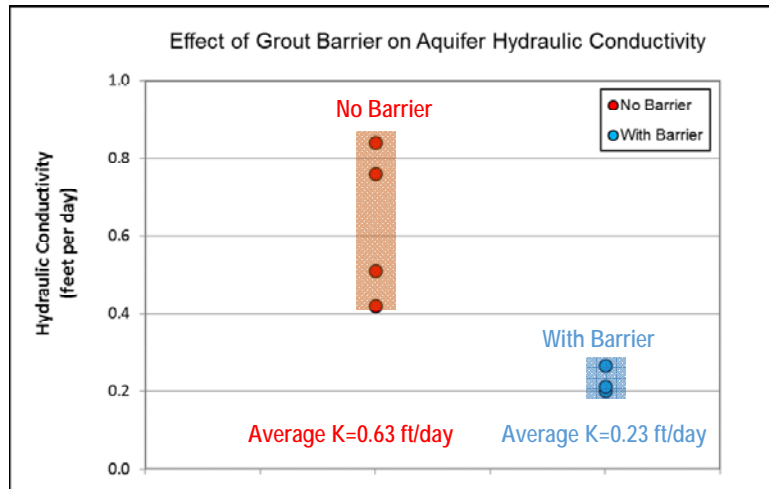

Figure ES-3: Results of Small-Scale Demonstration

- Applications of one acre in area or more are significantly less costly than conventional in-situ remediation technologies (\$996K per acre and \$21 per cubic yard for a one acre site).

Project Tasks

- Task 1: Research Flux Reduction Materials: Several novel silica gel/vegetable oil-formulations were developed and tested in lab-scale batch and column studies by project team member Solutions-IES. Desired characteristics of these formulations were potential long-term restoration of permeability and the potential for enhanced biodegradation of contaminants in the small portion of groundwater passing through barrier (all groundwater barriers leak). In a parallel effort, the technical literature regarding properties and field injection protocols of conventional silica gel was reviewed and supplemented with confirmation lab tests at GSI to select the most cost-effective silica gel material and the specific silica gel hardening reagent necessary for subsurface gelling. The results of this evaluation were used to select one type of silica gel and a vegetable-oil formulation for the Small-Scale field demonstration (Task 2).
- Task 2: Perform a Small-Scale Field Demonstration: Test cells were constructed in an unimpacted zone at the demonstration site. Two cells were constructed with the selected silica gel solution and two cells were constructed with the vegetable-oil formulation developed by Solutions IES. The main goal of the Small-Scale demonstration was show positive performance of a small barrier test cell, and to demonstrate how commonly used remediation equipment (direct push rigs, injection skids) can be adapted to make permeation grouting barriers.
- Task 3: Expand to a Large-Scale Field Demonstration: The results of Task 2 (Small-Scale Field Demonstration) were designed to make a go / no-go decision for a larger-scale technology demonstration. Key performance metrics involved the measurement of the change in mass flux, hydraulic gradient and geochemical parameters. Because the design work on Task 3 was conducted partly in parallel to the other Tasks, a site had been selected, a conceptual design completed, and some detailed design work was performed.

However, the results of the Small-Scale Field Demonstration did not reach the pre-established performance goals and therefore the Large-Scale Field Demonstration was not performed.

Results

- Two grout mixtures were selected based on gel tests and a treatability study by Solutions-IES:
 - *A Silica Gel Grout*: 10 vol-% of sodium silicate, 5 vol-% of dibasic ester hardener, and 85 vol-% of water. This formulation had a gel time of approximately 4 hours and had an estimated viscosity of 3-4 cP.
 - *Solutions-IES Novel Silica Gel/Veg-Oil Grout*: 5 wt-% of emulsified vegetable oil (EVO), 10 wt-% of sodium silicate, 1.8 wt-% of dibasic ester, and 83 wt-% of water. This formulation provided a 3-4 orders of magnitude reduction in lab permeability tests, and a gel time of 18 hours.
- A Small-Scale Demonstration was performed, but resulted in a 64% reduction in groundwater flow. The reason for the lower-than-expected performance was likely the low hydraulic conductivity (7×10^{-5} cm/sec) in the test area that had two effects: 1) it was on the low range of recommended application range for silica gels, making it difficult to emplace the grout; 2) it made it difficult to accurately measure barrier performance.
- Performance of 90% groundwater flow reduction with silica gel grouting is likely achievable at sites with the main transmissive units having hydraulic conductivity closer to the optimal range (from 5×10^{-4} to 10^{-2} cm/sec).
- Other grouts are available for conditions outside the optimal range for silica gel: cement grouts for units above 1×10^{-1} cm/sec, and acrylate grouts for lower permeability units. Note that these grouts are more expensive than silica gel (particularly the acrylate grouts).
- Application of a revised cost model based on data from this study show costs of $\sim \$21/\text{yd}^3$ and $\$996\text{K}$ per acre for a silica gel application, which is $<50\%$ than commonly reported unit costs for in-situ treatment technologies.
- Based on field experience of the Small-Scale Demonstration, the process is moderately complex to implement in the field but with no major problems.



Lessons Learned

How to Build Source Zone Barriers

- A general decision logic for applying the technology is shown in Figure ES-4.

- The technical literature is very helpful to understand how to design and build permeation grouting barriers. Two key references are Powers et al. (2007) and Karol et al. (2003) (Section 5.1.1)
- Different grouts can be applied for different conditions, with acrylamides being useful for very low permeability formations and cements for high permeability ones. The minimum range for application of silica gel grouts was reported to 1×10^{-6} to 1×10^{-5} cm/sec by one reference, while a second reference suggested a minimum hydraulic conductivity of 1×10^{-4} cm/sec. Note that silica gel is much cheaper and easier to use than acrylamide grouts and concrete grouts are more commonly used for coarse alluvial material.
- Groups interested in implementing the barrier technology have two broad options: 1) Hire a geotechnical contractor and use permeation grouting equipment (such as tube-a-manchette) or other barrier technologies (e.g., slurry wall or sheet piles); 2) or use commonly used remediation equipment such as direct push rigs with modified injection equipment to mix silica gel, hardener, and water (see Section 5.4 and Appendix E for information about the mixing skid used for this project).

Benefits of Barriers

- One of the benefits of the barrier technology is the potential for enhancing NSZD by establishing an enhanced reductive dechlorination zone when the competing electron acceptors are diverted. One research paper (Newell and Aziz, 2004) estimate a potential increase in NSZD rates of 226 kg/year (500 lbs/yr) at a typical chlorinated solvent site with electron acceptor diversion and 100% efficiency; see Appendix A for an example calculation at a hypothetical site and the BIOBALANCE tool (Kamath et al, 2008) for more information. A key requirement is that the site is contains electron donor in the source zone, either that is from naturally occurring organic material in the source zone; fermentable oils or other electron donors that were released along with the chlorinated solvents (a fairly common occurrence at DoD sites); or there has been an electron donor addition project to accompany the construction of the barrier.

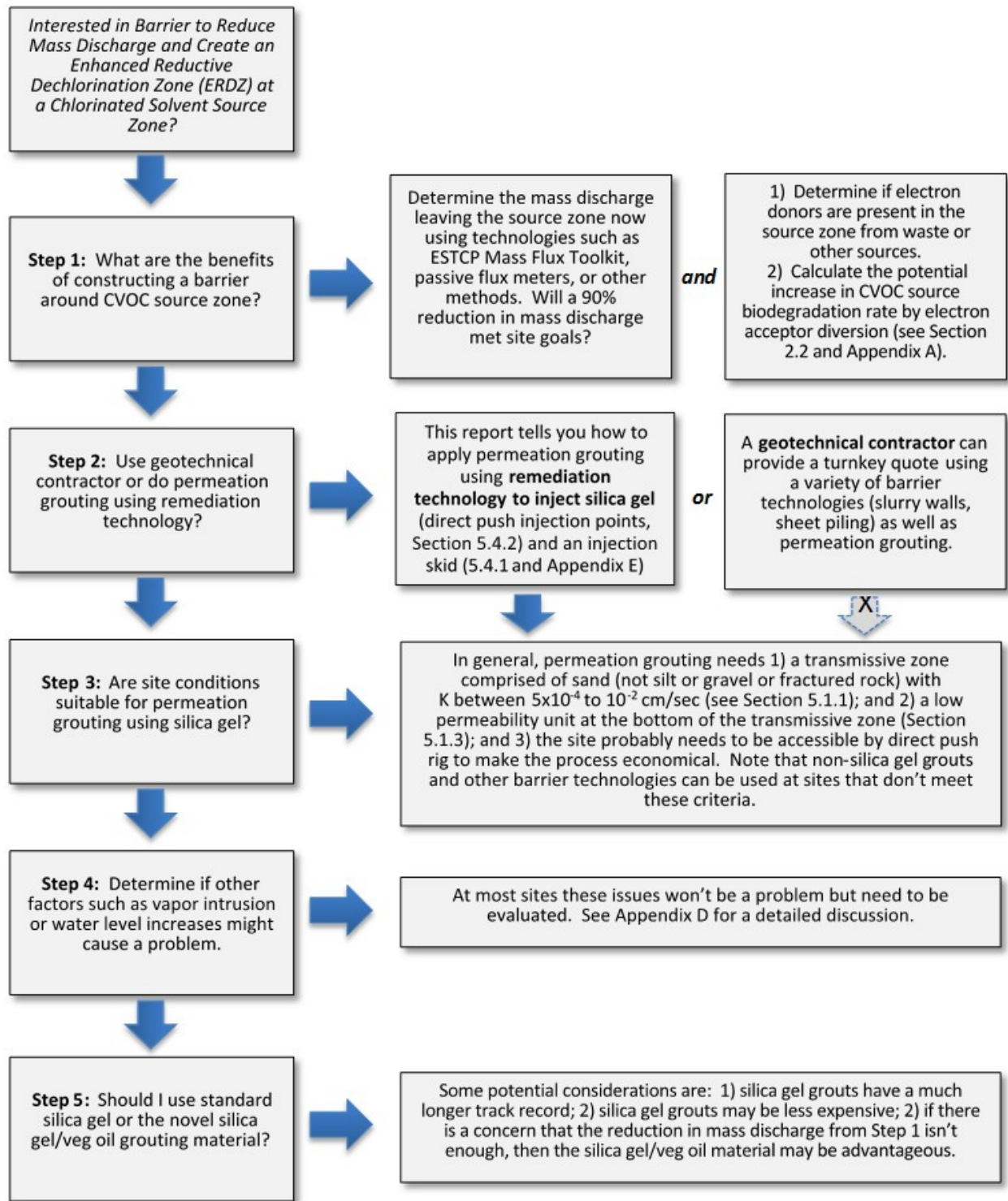

Figure ES-4: Decision Logic for Applying Barrier Technology at CVOC Sites

What Type of Site Conditions Are Needed

- For high efficiency barriers with significant flow reduction, the site must have a lower low permeability unit such as a clay to prevent up flow; and a four sided barrier is recommended (three sided barriers are likely to have lower performance (Section 5.1.3).
- For accessing the lower cost silica gel grouting technology, the hydraulic conductivity of the transmissive unit should be in the range of 5×10^{-4} to 10^{-2} cm/sec.
- The source zone should contain electron donor to realize the benefit of electron acceptor diversion that a barrier provides. Sites with faster groundwater will have more benefit than sites with slow groundwater.

Using Existing Remediation Technology for Barriers

- This ESTCP demonstration was able to use existing remediation technology (direct push rigs and injection skids) to build four small barriers for the Small-Scale Demonstration.
- The mixing process is generally more complex than standard injection-based remediation projects because the injection skid needs to mix three fluids, delivery multiple locations simultaneously, let operators see pressure, flowrate, and have contingency for grout set-up in the injection manifolds. The design described in Section 5.4 and Appendix E worked well.



Designing Permeation Grout Barriers

- Permeation grouting requires filling all the porosity, not just the mobile porosity. This increases the amount of grout required for the barrier as total porosity in the 24% to 44% range are typically used for the volume of grout needed calculation compared to 2% to 10% for the mobile porosity. Note the Small Scale Demonstration and the calculations in Section 6 assumed 30% porosity for the fine sand present in the test area.
- Munitions can complicate installation, but same holds for any injection based technology.
- The silica gel grout was much more reliable in terms of grouting times when the inorganic hardener (dibasic ester (DBE)) was used (Section 5.3). On-site gel tests are important to confirm that the soil chemistry will work with the design mix of gel and hardener (Section 6.1.2). This is particularly true at sites with saline groundwater.
- If a direct push rig is used for injection and the injection zone is more than a few feet thick, multi-level injection wells (Section 5.4.2) are important to ensure even vertical distribution of the grout. If a permeation grouting contractor is used, a tube-a-manchette rig will provide good vertical distribution of grout in the barrier.

Design and Performance of Small Scale Demonstration

- It was difficult to assess performance of the barrier for the Small-Scale Demonstration at the chosen location. Contributing factors include:
 - The hydraulic conductivities were relatively low (0.63 feet per day (2×10^{-4} cm/sec)) (Section 6.3.2) resulting in low pumping rates (< 0.1 gpm) and low volumes of extracted groundwater during the before- and after-tests (< 20 gallons);
 - Potential construction problems associated with the multi-level injection wells in a very fine-grained heterogeneous unit (Section 5.4.2) as one injection well had to be abandoned (Section 6.2).
- The “donut” configuration (Section 5.1.2) may have not been efficient at testing the permeation grouting process; a larger demonstration area may have resulted to better test data. However using constant head injection tests, **an average of 64% reduction in flow resulted**, which is significant but below the 90% reduction performance goal. This result, and relatively low hydraulic conductivities in the planned Northern Plume test area, led to the decision not to perform the Large-Scale Demonstration.
- Applications for the flux reduction technology are likely to have better performance at sites with higher permeability and higher groundwater velocity than at the site used for the demonstration, both for demonstrating the hydraulic effect of the barrier and the benefits from electron acceptor diversion.

Novel Grouting Material

- The Solutions-IES novel grout material consisting of a silica gel/veg oil mix appeared to work as well as conventional silica gel for reducing flow (Table 6.4), but since the Small-Scale Demonstration was performed in a relatively unimpacted zone, the project was unable to test its dechlorination capabilities in the field. The theory behind the gel/oil material is sound as permeation grouting barriers are designed to reduce but not eliminate groundwater flow through them, therefore providing a mechanism for increased treatment with the oil.



1.0 INTRODUCTION

The overall objective of this project was to evaluate if inexpensive flow reduction agents delivered via permeation grouting technology could help manage difficult-to-treat chlorinated solvent source zones. This approach aims to provide two benefits for improving groundwater quality at chlorinated volatile organic carbon (CVOC) sites by:

1. physically reducing the mass flux of contaminants leaving the source zone, thereby reducing risk and making the downgradient plume more amenable for management by natural attenuation processes; and
2. increasing the Natural Source Zone Depletion (NSZD) rate within the source by diverting competing electron acceptors (e.g., dissolved oxygen, nitrate, and sulfate) around the source zone to create an enhanced reductive dechlorination zone (ERDZ). The influx of competing electron acceptors into treatment zones can consume a large fraction of the available electron donor supply at bioremediation sites, necessitating more frequent substrate reinjection.

Natural Source Zone Depletion (NSZD) and Enhanced Reductive Dechlorination Zones (ERDZs)

NSZD is the term for the attenuation of the source zone itself at a contaminated groundwater site from processes such as mass loss to moving groundwater and biodegradation in the source zone (Newell et al., 2014)

One way to increase NSZD rates at chlorinated solvent sites is to use a barrier to divert competing electron acceptors (oxygen, nitrate, and sulfate) around the source zone, thereby making the geochemistry inside the barrier more conducive for anaerobic biodegradation. This is called an ERDZ (Kamath et al., 2008)

To test these concepts, three tasks were designed, with work on the third task to be contingent on the results of the first two tasks:

- Task 1: Flux Reduction Material Formulation: Two types of flow-reduction materials for permeation grouting were evaluated in terms of performance (i.e., flux reduction properties), cost, ease of installation, and longevity: 1) conventional physical compounds such as silica gel that are frequently used in the geotechnical field for “water tightening” (permeation grouting) purposes; and 2) a novel vegetable oil formulation developed and selected by one of the project team members, Solutions-IES, that in addition to water tightening capability it promoted biodegradation CVOCs passing through the barrier. Laboratory testing and review of available scientific literature were performed to select the most appropriate vegetable oil formulation and silica gel solution for the Small-Scale field demonstration.
- Task 2: Small-Scale Field Demonstration: Test cells were constructed in a clean zone at the demonstration site. Two cells were constructed with the selected silica gel solution and two cells were constructed with the vegetable-oil formulation developed by Solutions IES. The main goal of this Small-Scale demonstration was to demonstrate that remediation technology (direct push rigs and subsurface injection experience) could be used to make permeation grouting barriers at contaminated sites. In addition, the reduction in aquifer transmissivity was evaluated to compare the relative performance of both materials.

Permeation Grouting

Permeation grouting is the flow of grout into the pores of the soil, without displacing or changing the soil structure, resulting in modification of the characteristics of the ground with the hardening or gelling of the grout. One way permeation grouting is used is to decrease the permeability of the soil or provide "watertightening" (Powers et al., 2007)

- Task 3: Large-Scale Field Demonstration: The results of Task 2 (Small-Scale Field Demonstration) were designed to make a go / no-go decision for a larger-scale technology demonstration. Because the design work on Task 3 was conducted partly in parallel to the other Tasks, a site had been selected, a conceptual design completed, and some detailed design work was performed. However, the results of the Small-Scale Field Demonstration did not reach the pre-established performance goals and therefore the Large-Scale Field Demonstration was not performed.

1.1 BACKGROUND

SERDP/ESTCP recently identified “*Treatment of Contaminants in Low-K Zones*” as a “High” Research and Development need for the Department of Defense (DoD) remediation program (Leeson and Stroo, 2011). These types of sites represent an increasing fraction of the DoD’s chlorinated site portfolio, as the easier and smaller source zones are successfully treated. For example, sites dominated by matrix diffusion-type sources from low permeability (Low-K) zones are increasing for two reasons: 1) untreated sites continue to age and transform from Middle Stage sites (sites where DNAPL sources are active) to Late Stage Sites (sites where matrix diffusion sources dominate) (Sale et al., 2008); and 2) more chlorinated solvent source zones are treated and the bulk of the DNAPL is removed, but the low-permeability source zones are still too strong to close the site or rely on MNA processes.

One of the likely side effects of matrix diffusion dominated sites is concentration rebound after in-situ treatment. This has been commonly observed at sites treated with chemical oxidation (e.g., McGuire et al, 2005; Krembs et al., 2010), and it has been speculated that rebound can occur at sites treated with in situ bioremediation if monitoring is continued for longer periods. A key paper describing sustained treatment (Adamson et al., 2011) makes the case that even for apparent long-lasting technologies, some of the treatment effects will diminish over time, and that periodic reapplication of treatment chemicals may be needed over the lifetime of the site. If this is the case, then the Department of Defense’s remediation liability over the decades-long periods that these sources will be active may be much larger than currently estimated.

For these long-lived, difficult-to-treat sites, inexpensive (in units of dollars per cubic yard, or dollars per acre) technologies are needed that can: 1) immediately and reliably address the key problem associated with these recalcitrant source zones, specifically the mass flux of contaminants leaving the source zone; 2) increase the actual treatment of the contaminants leaving Low-K source zones, or DNAPL; and 3) last for decades or longer. To evaluate the impact of remediation at these sites, mass flux (or mass discharge) is the most useful measurement because it establishes the amount of mass per unit time leaving the source zone (Newell et al., 2011).

The project envisions site managers could access the technology in two ways:

1. Contract existing geotechnical permeation grouting vendors to install physical barriers at contaminated sites, either using permeation grouting or other barrier techniques (slurry walls, sheet piling, etc.) This has the advantage of simpler turn-key approach, but may have the disadvantage of higher costs if the contractor is unfamiliar with and untrained for working at hazardous waste sites. Note that permeation contractors have a specialized tool called tube-a-manchette that they use for many permeation grouting projects.

2. Use existing remediation contractors for applying direct-push technology and modified injection skids to perform the permeation grouting. Most of the project was devoted to explaining how to perform permeation grouting can be implemented by using conventional remediation technology.

Contaminant flux reduction barriers can potentially prove to be an innovative application of existing technologies that can meet these objectives inexpensively and reliably. This technology provides long-term (decades) or permanent treatment of source zones where the mass flux is greatly reduced, back diffusion and/or DNAPL sources are reliably managed, and contaminant attenuation rates within the source zone are substantially increased. Unit costs for flux reduction treatment of an acre site are anticipated to be ~ \$21 per cubic yard and < \$1 million per acre. This is significantly less than reported unit cost for in-situ biodegradation (\$30-180 per cubic yard), chemical oxidation (median \$125 per cubic yard), and thermal remediation (median \$161 per cubic yard) (McGuire et al., 2016); and lower than the analysis presented in Sale et al. (2008) that showed that costs for chlorinated solvent source zone remediation “will range between \$1 million and \$5 million per acre.” For the performance criteria for this project, we assumed a typical in-situ remediation cost of **\$3 million per acre**.

1.2 OBJECTIVE OF THE DEMONSTRATION

The objective of this ESTCP field demonstration was to: 1) evaluate different flux reduction agents, including novel materials; 2) conduct a Small-Scale field study to evaluate permeation grouting materials in terms of cost, ease of installation, and performance (i.e., flux reduction properties) and 3) conduct a larger-scale field demonstration with the best-performing material to evaluate the reduction in contaminant mass flux and hydraulic gradient and the creation of enhanced anaerobic conditions for contaminant biodegradation.

Specific performance objectives and success criteria are described in Section 3.

1.3 REGULATORY DRIVERS

SERDP/ESTCP recently identified “*Treatment of Contaminants in Low-K Zones*” as a “High” Research and Development need for the Department of Defense (DoD) remediation program (Leeson and Stroo, 2011). These types of sites represent an increasing fraction of the DoD’s chlorinated site portfolio, as the easier and smaller source zones are successfully treated. For example, sites dominated by matrix diffusion-type sources from low permeability (Low-K) zones are increasing for two reasons: 1) untreated sites continue to age and transform from Middle Stage sites (sites where DNAPL sources are active) to Late Stage Sites (sites where matrix diffusion sources dominate) (Sale et al., 2008); and 2) more chlorinated solvent sources zones are treated and the bulk of the DNAPL is removed, but the low-permeability source zones are still too strong to close the site or rely on MNA processes.

The National Research Council (NRC) has recently advanced an important new concept about managing contaminated groundwater sites called a Transition Assessment. Despite years of effort and considerable investment, many sites “will require long-term management that could extend for decades or longer.” The NRC discusses the need for developments that can aid in “transition from active remediation to more passive strategies and provide more cost-effective and protective long-term management of complex sites,” including conducting formal Transition Assessments.

This concept, which is an intrinsic part of the ITRC's Integrated DNAPL Site Strategy (IDSS) framework, has now been validated by a key U.S. scientific body, the National Research Council.

The Contaminant Flux Reduction Barrier technology is targeted to address sites dominated by matrix diffusion and/or that are candidates for long-term passive management of a site. At these sites, further active remediation (such as chemical oxidation, bioremediation, chemical reduction, thermal treatment) will likely not change the long-term management of the site because of the residual contaminants in low permeability zones. If MNA will not be protective, there is a need for a technology that will reduce the mass flux from these zones and have the potential for some accelerated NSZD of the remaining chlorinated solvent mass.

2.0 TECHNOLOGY

2.1 TECHNOLOGY DESCRIPTION

The technology combines the concepts of source zone attenuation, high-resolution mass flux, and enhanced biodegradation. The original concept was to reduce groundwater flow by reducing the “mobile porosity” of the saturated zone, which carries most of the groundwater flow and typically ranges from 0.02 to 0.10 (e.g., 2% to 10% of the pore space carries most of the groundwater flow (Payne et al., 2008). By using permeation grouting for “water tightening”, liquid injectable grouts are injected into the subsurface and naturally flow into the mobile porosity. The grouts contain a hardening agent that converts the liquid grout into a solid gel that blocks groundwater flow through the pore space. One key concept is that the technology is designed to reduce, but not totally eliminate groundwater flow through the barrier. Water tightening by geotechnical contractors inherently has some residual flow, which is important for this application to accommodate infiltration water that enters the enclosed source zone from the top. As described in Section 7, the concept of grouting just the mobile porosity was optimistic, and grouting the entire porosity (typical between 24% and 44%) in the volume of the barrier is required for a tight seal (90% reduction in groundwater flow or more).

A second benefit is that by creating a barrier around a treatment zone, groundwater flow carrying competing electron acceptors will be diverted, resulting in an engineered reaction zone similar to the Enhanced Reductive Dechlorination Zone (ERDZ) concept that was developed by Newell et al. (2003, 2004) and is part of the Biobalance Toolkit (Kamath et al., 2008). The reduction in competing electron acceptors in the treatment zone enables the appropriate geochemical environment for an enhanced reductive dechlorination zone (Newell et al., 2004). A spreadsheet calculator for that lays out the calculations for estimating the benefits from a ERDZ is shown in Appendix A.

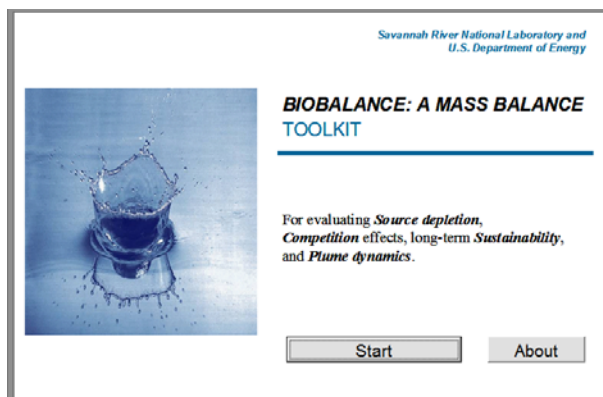

The specific tasks of the project are as follows:

1. Task 1: Flux Reduction Material Formulation: Several novel silica gel/vegetable oil-formulations were developed and tested in lab-scale batch and column studies by project team member Solutions-IES. Desired characteristics of the formulations were potential long-term restoration of permeability and the potential for enhanced biodegradation of contaminants in the small portion of groundwater passing through barrier (all groundwater barriers leak). In a parallel effort, the technical literature regarding properties and field injection protocols of conventional silica gel was reviewed and supplemented with confirmation lab tests at GSI to select the most cost-effective silica gel material and the specific silica gel hardening reagent necessary for subsurface gelling. The results of this evaluation were used to select one type of silica gel and a vegetable-oil formulation for the Small-Scale field demonstration (Task 2).

- Task 2: Small-Scale Field Demonstration: Test cells were constructed in a relatively unimpacted zone at the demonstration site. Two cells were constructed with the selected silica gel solution and two cells were constructed with the vegetable-oil formulation developed by Solutions IES. The main goal of the Small-Scale demonstration was show positive performance of a small barrier test cell, and to demonstrate how commonly used remediation equipment (direct push rigs, injection skids) can be adapted to make permeation grouting barriers.
- Task 3: Large-Scale Field Demonstration: The results of Task 2 (Small-Scale Field Demonstration) were designed to make a go / no-go decision for a larger-scale technology demonstration. Key performance metrics were to include the change in mass flux, hydraulic gradient and geochemical parameters will be measured. Because the design work on Task 3 was conducted partly in parallel to the other Tasks, a site had been selected, a conceptual design completed, and some detailed design work was performed. However, the results of the Small-Scale Field Demonstration did not reach the pre-established performance goals and therefore the Large-Scale Field Demonstration was not performed.

2.2 TECHNOLOGY DEVELOPMENT

2.3 ADVANTAGES AND LIMITATIONS OF THE TECHNOLOGY

2.3.1 Advantages of the Technology

The key advantage of this technology is that creating flow/mass flux reduction barriers around the perimeter of difficult-to-treat source zones is less expensive than treating the entire volume of the source zone. In addition, there are potential benefits of reducing the influx of competing electron acceptors, thereby establishing an Enhanced Reduction Dechlorination Zone at chlorinated solvent sites that already contain electron donors within the source zone.

Costing models show that this technology has the potential to be significantly cheaper (approximately \$21 per cubic yard for large sites) (Section 6), provide better performance, and be more predictable and reliable than existing technologies for larger sites. Unlike most remediation systems in which costs are directly proportional to the size of treatment areas, this technology has decreasing costs per source zone area. If proven to be feasible, the proposed methods are also easy to implement and scale up, making them attractive options for closing large sites.

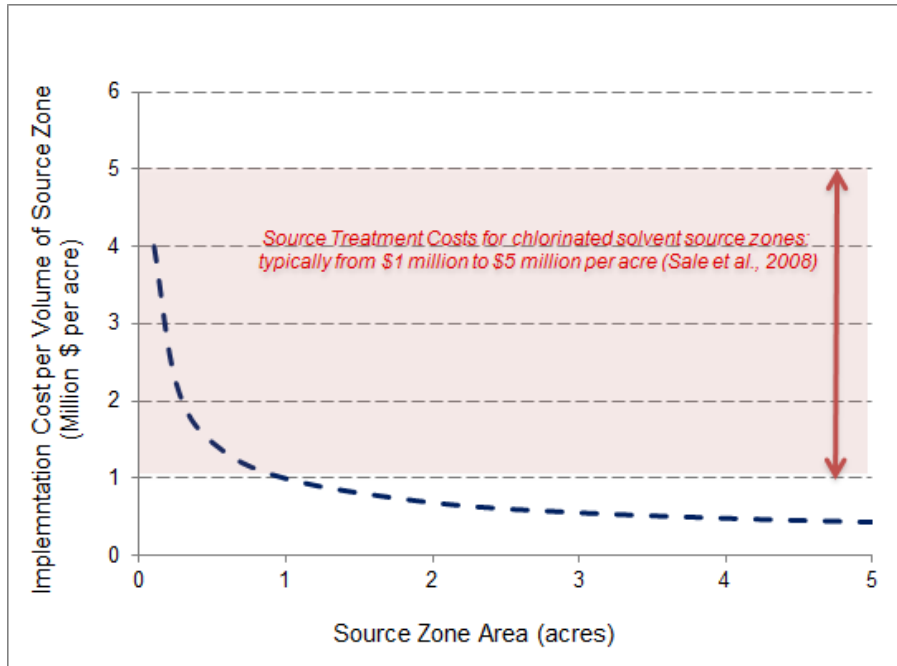

Figure 2.1: Approximate Cost Model for Application to Various Source Zone Areas

Assumes treatment zone thickness of 30 ft, and injection well spacing of 4 ft.

Additionally, little to no maintenance and operating costs are involved, making this a very cost-effective technology over the long term. The lifetime of most grouts is relatively long; for example cement grouts are expected last indefinitely unless in unusual groundwater conditions. One grouting reference (Karol, 2003) stated that silica gel grouts are expected to have a 50-year lifetime. The implementation of this technology also requires minimal subsurface disturbance and waste materials.

Finally, the technology provides an isolation of the source zone or plume, reduces mass discharge, and enhances biodegradation within the treatment zone.

2.3.2 Limitations of the Technology

Potential limitations of the technology include:

- No direct active treatment and reliance on NSZD alone for treatment may not be acceptable to site stakeholders. Even though the NSZD rate of the chlorinated solvents in the source zone is likely to be increased, longer remediation timeframes are expected compared to active treatment.
- The silica gel / injected materials are semi-permanent, making complete restoration of the treatment zone to pre-impact conditions difficult;
- The technology does not control the vapor intrusion pathway, and other controls will be required if this pathway is active;

- At a small number of sites, the accumulation of water within the barriers and elevated water levels may occur if the barrier is too tight and does not have a method to release accumulated groundwater.
- Access may be a problem for construction of the barrier, but this is likely to be a much smaller problem compared to application of most in-situ treatment technologies.
- High mobilization costs may make the technology less cost effective for small sites.

3.0 PERFORMANCE OBJECTIVES

Our overall objective was to demonstrate a treatment technology for difficult-to-treat chlorinated solvent source zones that focuses on *reducing the groundwater flow through a chlorinated solvent source zone*. There are two significant benefits associated with this approach: 1) it will reduce the mass flux of contaminants leaving the source zone; and 2) it will increase the biodegradation rate within the source as competing electron acceptors (dissolved oxygen, nitrate, and sulfate) are diverted around the source zone.

Specific objectives for demonstration project were to:

1. Evaluate two different flow-reduction materials in terms of cost, ease of installation, effectiveness: a vegetable-oil formulation and a silica gel grout.
2. Determine cost factors of this technology relative to conventional remediation strategies for chlorinated solvents in terms of key unit costs (\$ cubic yard and \$ per acre).
3. Evaluate ease of installation and injection procedures in the field.
4. Determine if a 1 Order of Magnitude (OoM) or greater reduction in mass discharge from actual treatment zones is achievable using this flux reduction technology.
5. Demonstrate that enhancement of anaerobic conditions within treatment zones once groundwater flow is diverted is possible and estimate the potential increase in chlorinated solvent degradation rate using BIOBALANCE model (Kamath et al., 2008).

Specific performance objectives are summarized in Table 3.1.

Data from the Small-Scale demonstration was used to assess changes in flow reduction which is generally proportional to mass flux reduction at most contaminated sites. As the Large-Scale Task 3 demonstration was not conducted, some performance objectives could not be evaluated.

Table 3.1: Performance Objectives of the Small-Scale and Large-Scale Demonstrations

<i>Performance Objective</i>	<i>Data Requirements</i>	<i>Success Criteria</i>
<i>Quantitative Performance Objectives</i>		
Evaluate flow-reduction materials in terms of cost and reduction in aquifer transmissivity	1. Unit cost for installing barrier for two injection materials (Small-Scale Demo); 2. Transmissivity of treatment zone before and after barrier installation (Small-Scale Demo); 3. Groundwater flow before and after barrier installation (Large-Scale Demo); 4. Change in hydraulic gradient (Large-Scale Demo)	Reduction in groundwater flow of at least 1 order of magnitude (90% reduction) <i>NOT ACHIEVED: A 64% reduction in groundwater flow was estimated for the Small-Scale Demonstration; thereby the performance metric was not achieved.</i>
Determine cost factors of technology relative to conventional remediation strategies	Project costs (\$ per cubic yard and \$ per acre); estimates for applying more conventional in situ technologies at similar scale using literature values (e.g., McDade et al., 2005) (Large-Scale Demo)	Life-cycle cost (20 year time frame) for flux reduction material application < 50% of current in-situ treatment technologies for a 1-acre site. <i>ACHIEVED: Application of a revised cost model based on data from this study show 33% cost of typical in-situ remediation project of \$3 million per acre (Sale et al.,2008) .</i>
Evaluate reduction of mass flux at chlorinated solvent site	Mass flux of contaminants before and after barrier installation, determined through the use of PFMs (Large-Scale Demo)	Mass flux reduction of similar order of magnitude as reduction in groundwater flow: at least one order of magnitude (90% reduction) <i>NOT APPLICABLE: The Large-Scale Demonstration was not performed so the performance metric was not evaluated.</i>
Determine enhancement of anaerobic conditions within treatment zone once groundwater flow is diverted	Geochemical parameters such as dissolved oxygen, sulfate, nitrate, and oxygen-reduction potential (Large-Scale Demo)	Calculated 90% reduction in soluble electron acceptor flux using ESTCP Mass Flux Toolkit; calculated reduction in electron acceptor concentrations in treatment zone; evaluation of benefits using BIOBALANCE Tool. <i>NOT APPLICABLE: The Large-Scale Demonstration was not performed so the performance metric was not evaluated.</i>
<i>Qualitative Performance Objectives</i>		
Ease of installation	Feedback from field personnel on material preparation and injection process, including pressures and rates	Material preparation and injection is predictable. <i>ACHIEVED: Based on the experience of the Small-Scale Demonstration, the process is moderately complex to implement in the field but with no major problems. This metric is considered to be achieved.</i>

3.1 PERFORMANCE OBJECTIVE: EVALUATION OF FLOW REDUCTION MATERIALS

The effectiveness of the technology is dependent on the appropriate selection of a flux reduction material that is cost effective, and is able to reduce groundwater flow through the treatment zone after the installation of the barrier.

3.1.1 Data Requirements

The two permeation grouting flux reduction materials (i.e., conventional silica gel and novel silica gel/vegetable oil formulation) were evaluated on the basis of cost and the reduction on groundwater transmissivity during the Small-Scale demonstration.

3.1.2 Success Criteria

The objective will be considered met if one of the flux reduction materials is able to reduce groundwater flow by at least 1 order of magnitude (OoM) (>90% reduction) compared to pretreatment conditions. *NOT ACHIEVED: A 64% reduction in groundwater flow was estimated for the Small-Scale Demonstration; thereby the performance metric was not achieved.*

3.2 PERFORMANCE OBJECTIVE: DETERMINE COST FACTORS FOR TECHNOLOGY

The cost of this technology will be important in determining its effectiveness, particularly in comparison to existing remediation technologies at chlorinated solvent sites.

3.2.1 Data Requirements

Cost factors will be evaluated on the basis of total project costs (\$ per cubic yard and \$ per acre), and compared to costs for conventional in-situ technology estimates using literature values (e.g., McDade et al., 2005).

3.2.2 Success Criteria

The objective will be considered met if the life-cycle cost (20 year time frame) for the flux reduction barrier application is less than 50% of current in-situ treatment technologies for a 1-acre site. *ACHIEVED: Application of a revised cost model based on data from this study show \$21/yd³, which is <50% of current in-situ treatment technologies; thereby the performance metric was achieved.*

3.3 PERFORMANCE OBJECTIVE: EVALUATE REDUCTION OF MASS FLUX AT CHLORINATED SOLVENT SITE

One of the key objectives of the Large-Scale demonstration at a chlorinated solvent site is to show a reduction in the mass flux of contaminants within the treatment zone.

3.3.1 Data Requirements

Mass flux of contaminants (e.g., trichloroethene [TCE]) will be measured before and after the installation of the barrier using Passive Flux Meters.

3.3.2 Success Criteria

This objective will be considered met if the mass flux reduction is at least one order of magnitude (90% reduction). *NOT APPLICABLE: The Large-Scale Demonstration was not performed so the performance metric was not evaluated.*

3.4 PERFORMANCE OBJECTIVE: DETERMINE POTENTIAL FOR ENHANCEMENT OF REDUCTIVE DECHLORINATION PROCESSES

The diversion of groundwater flow is expected to create anaerobic conditions at a chlorinated solvent site within the treatment zone.

3.4.1 Data Requirements

The performance objective will be evaluated by determining the mass discharge of geochemical parameters in groundwater such as dissolved oxygen, sulfate, nitrate, and oxygen-reduction potential during the Large-Scale demonstration, both before and approximately two months after barrier installation. The ESTCP Mass Flux Toolkit will be used to help calculate the reduction in the mass discharge of these competing electron acceptors into the zone inside the flux reduction barrier. The Department of Energy's BIOBALANCE Tool will take this data to estimate the potential increase in rate of degradation of chlorinated solvents within the barrier using hydrogen equivalents for reduction in competing electron acceptors and the corresponding increase in available electron donors.

3.4.2 Success Criteria

The objective will be considered met if there is i) a measurable reduction in electron acceptor concentrations in treatment zone during the Large-Scale demonstration, ii) a 90% reduction in incoming soluble electron acceptor flux using ESTCP Mass Flux Toolkit, and iii) calculated increase in degradation rate (in units of grams per day) using the calculation approach in the DOE's BIOBALANCE Tool. *NOT APPLICABLE: The Large-Scale Demonstration was not performed so the performance metric was not evaluated.*

3.5 PERFORMANCE OBJECTIVE: EASE OF INSTALLATION

If successful, the implementation of the technology and installation of barriers will be predictable and applicable at most sites without access issues.

3.5.1 Data Requirements

During both the Small-Scale and Large-Scale demonstrations, feedback from field personnel on material preparation, injection process, and injection pressures and rates will be recorded.

3.5.2 Success Criteria

This objective will be met if the material preparation and injection is predictable and repeatable at various sites. *ACHIEVED: Based on the experience of the Small-Scale Demonstration, the process is moderately complex to implement in the field but with no major problems. This metric is considered to be achieved.*

4.0 SITE DESCRIPTION

Site 17 at the Naval Support Facility (NSF), Indian Head in Indian Head, Maryland was selected for the field demonstration (Tasks 2 and 3), based on the following site criteria:

- Shallow depth to groundwater (<20 ft)
- Transmissive zone preferably with an underlying clay layer
- Good accessibility to source zone
- Availability of detailed hydrogeological information
- Uncontaminated zone to perform the Small-Scale demonstration

Site 17 of the NSF is located on a stretch of shoreline along the Mattawoman Creek in Indian Head, Maryland. From the 1960s until the early 1980s, metals parts were discarded here, including shipping containers, empty drums, motor casings, and other various metals parts (CH2M-Hill, 2008). Two chlorinated solvent plumes have been characterized, namely the North Plume and South Plume. The South Plume was remediated using soil mixing, and the North Plume was selected as the location of the Large-Scale demonstration for this project (Figure 4.1).

One difficult aspect of this site was the relatively low groundwater flow rate at the site. This made conducting the Small-Scale demonstration and measuring flow reduction due to the barriers more challenging.

4.1 SITE LOCATION AND HISTORY

The Small-Scale demonstration was conducted in a non-impacted area near the existing building north of South Plume and east of North Plume (Figure 4.1). This area was clear of trees and offered suitable access for installation of the test cells. The area was also close to existing monitoring well IS17MW03, which was used to assess the geology and degree of contamination, as described below. Because the Small-Scale demonstration was performed in a clean zone, no mass flux or electron acceptors measurements were made; the field test focused on reduction in groundwater flow with the presence of the barriers.

The Large-Scale demonstration was to be applied within the North Plume area, near the shore of Mattawoman Creek (Figure 2). A number of monitoring wells are present in the area (i.e., IS17MW04, IS17MW11, IS17MW12, IS17MW13, and IS17MW04) as part of ongoing delineation work by the Navy.

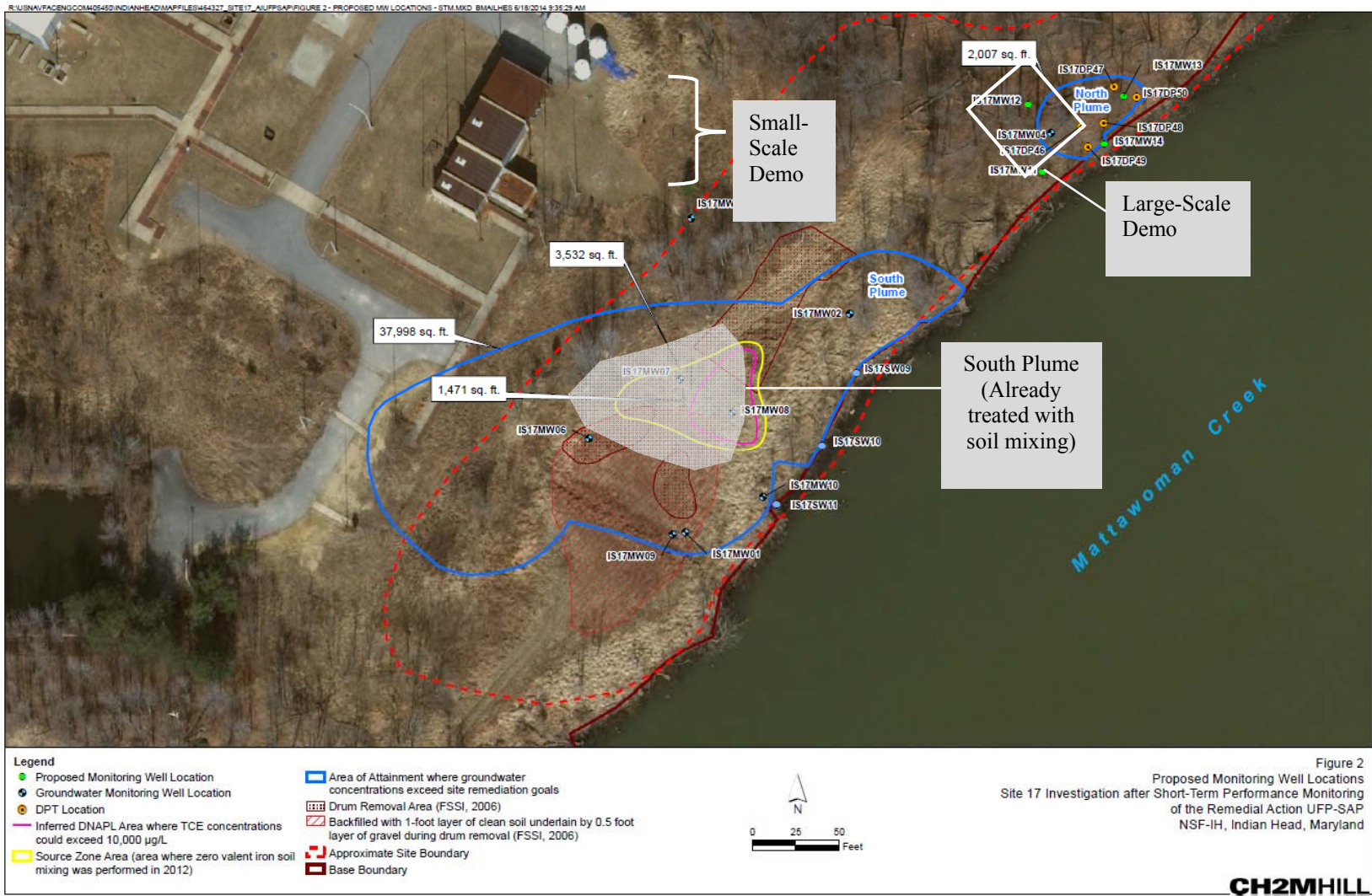

Figure 4.1: Locations of Small-Scale and Large-Scale Demonstration Areas

(basemap from CH2MHill, 2014, annotated by GSI)

4.2 SITE GEOLOGY / HYDROGEOLOGY

The geology in the region near IS17MW03 consists of an orange to gray clay to about 12 ft below ground surface (bgs), followed by a fine orange sand to 16 ft bgs (Appendix B). The **fine orange sand** is the uppermost water bearing unit beneath the silt and was the focus of the demonstration. Evaluation of the cross-sections at the site provide further vertical and lateral information of the site geology and are also included in Appendix B. As such, the area in the vicinity of well IS17MW03 is expected to contain an underlying clay layer at approximately 30 ft bgs.

Groundwater seepage velocities estimated for the South Plume ranged from 43 to 400 ft/yr (CH2M-Hill, 2008, Table 4.3).

Slug tests conducted in the Task 2 **Small-Scale Demonstration** location, a relatively unimpacted zone at well IS17MW03 (Figure 4.01) yielded hydraulic conductivity estimates ranging from 0.5 ft/day to 1.2 ft/day (1.6×10^{-4} cm/s to 3.2×10^{-4} cm/s) with an average of 0.9 ft/day (**3×10^{-4} cm/s**) (CH2M-Hill, 2008). The depth to groundwater at this well is approximately 11 ft bgs (6.72 ft msl) and groundwater generally flows from northwest to southeast, discharging to the Mattawoman Creek (CH2M-Hill, 2004).

The geology in the region near the **Task 3 Large-Scale Demonstration** location, the North Plume, generally consists of red-brown silt and silty sand from 0-9 ft bgs, followed by a clay layer to at least 20 ft bgs (Figure 3). Depth to groundwater is approximately 5 ft bgs and groundwater generally flows from northwest to southeast, discharging to the Mattawoman Creek (CH2M-Hill, 2004). Hydraulic conductivity measurements were collected in the North Plume and showed much lower hydraulic conductivity in this area range from 0.1 ft/day to 0.2 ft/day (**4 to 7×10^{-5} cm/sec**) (CH2MHill, 2012). A Passive Flux Meter was installed at well MW-04 and showed groundwater Darcy velocities of 0.12 cm/day (top measurement) and 0.17 cm/day (bottom measurements). Using a porosity of 0.20, this yields seepage velocities of 7.2 and 10 feet per year and with a hydraulic gradient of 0.04 ft/ft and hydraulic conductivity in the 4×10^{-5} to 5×10^{-5} cm/sec range.

Overall the geologic description (silty sands) and the hydraulic conductivity of the Northern Plume (**4 to 7×10^{-5} cm/sec**) were within, but at the far range of the silica gel grouting “rule of thumb” (minimum hydraulic conductivity of 1×10^{-5} cm/sec; see Section 5.1.1). In addition, the low groundwater flowrate in this area would have complicated the demonstration of the electron diversion performance metric as it would have taken several years to get a condition where a groundwater exchange would have taken place without the barrier.

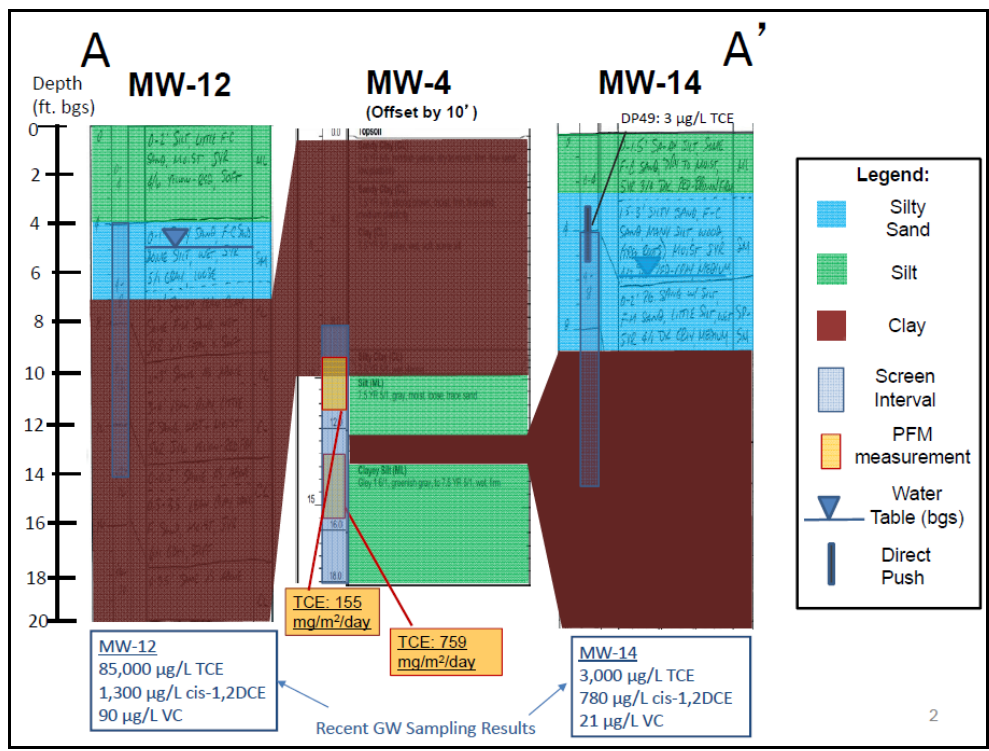
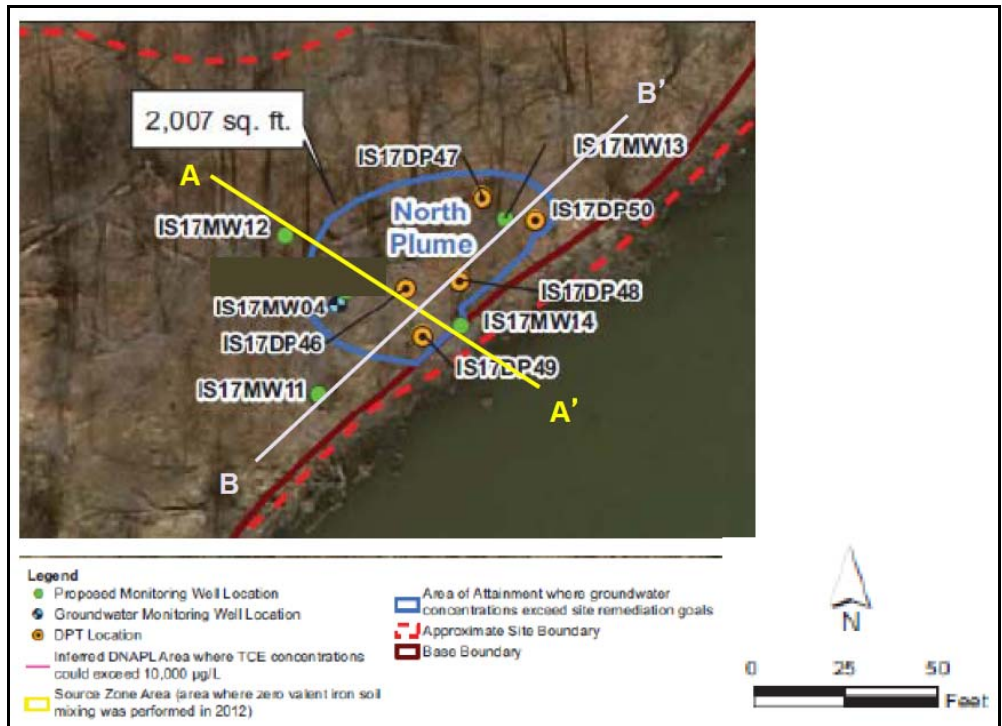

Figure 4.2: Plan View of North Plume (top) and Cross-Section A-A' (bottom)
(Preliminary Geologic Logs Provided by CH2M-Hill)

4.3 CONTAMINANT DISTRIBUTION

The Small-Scale demonstration was conducted in a clean area of the site in the vicinity of well IS17MW03 (Figure 4.1) to minimize the cost of disposing water during the pumping tests. Recent analytical results at well IS17MW03 reported very concentrations of TCE of 0.81 ug/L, and cis-1,2-dichloroethene (cis-1,2-DCE) and vinyl chloride (VC) below detection limits of 0.5 ug/L. As a precaution, groundwater extracted during the pumping tests was stored and tested prior to disposal in consultation with the Navy project manager.

The main contaminants in the North Plume are TCE, cis-1,2-DCE, and VC. Groundwater concentrations from July 2014 for these contaminants had the following ranges:

- TCE: ND ug/L (MW11) to 400,000 ug/L (MW04)
- cis-1,2 DCE: 0.91 ug/L (MW11) to 130,000 ug/L (MW04)
- VC: 0.9 ug/L (MW11) to 1,600 ug/L (MW04)

Preliminary mass flux measurements in MW04 using passive flux meters indicated TCE flux of 155 – 759 mg/m²/day (Figure 4.2). Soil concentrations from July 2014 indicate maximum TCE concentrations of 300 mg/kg at a depth interval of 12-16 ft bgs (near IS17MW12).

These contaminant characteristics were good for the demonstration of the flux reduction barriers and the ERDZ concept:

- the high concentrations suggest that in-situ remediation technologies would be difficult to implement in this area, leading to a barrier-approach to manage the site;
- the high concentrations of cis-1,2-DCE show that electron acceptors and reductive dechlorination are present in the source zone, and therefore diverting electron acceptors would have a beneficial effect.

Page Intentionally Left Blank

5.0 TEST DESIGN

5.1 CONCEPTUAL EXPERIMENTAL DESIGN

5.1.1 Description of Flux Reduction Materials/Formulations

The Small-Scale demonstration consisted of two types of cells, or barriers, each constructed with a different flux reduction material. Cell type 1 consisted of a silica gel grout mix (sodium silicate solution) similar to that commonly used for permeation grouting in construction projects. Cell type 2 consisted of a silica gel/vegetable-oil formulation produced by project team member Solutions-IES. The silica gel/veg oil material was selected after research and lab work performed by Solutions-IES.

GSI performed a detailed literature review of conventional permeation grouting techniques. The most useful design reference is Powers et al., 2007 (Chapter 22). Note there are some conflicting guidelines for applicability of permeation grouting, such as the minimum hydraulic conductivity specified in the data shown in Table 5.1 and the silica gel “rule of thumb” below. Key figures, tables, and information include:

- Applicability of various grout materials vs. hydraulic conductivity (Powers Figure 22.6, summarized in Table 5.1 of this report below). Concrete grouts are more commonly used for coarse alluvial material; silica gel grouts are applied to fine alluvial material (gravels and sands; sands; and silty sands).
- Grain size vs. percent passing chart to indicate groutability (Powers Figure 22.7).
- Chemical groutability chart vs. percent passing through 200 sieve: < 12%: Good; 12-20%: Moderate; 20-25%: Marginal; > 25%: Poor.
- Usual Range of Pre-Grouting and Post-Ground Hydraulic Conductivity (Figure 22-9). Generally the cleaner and coarser the ground, the greater (in orders of magnitude) the potential reduction in hydraulic conductivity. Note it has a higher minimum hydraulic conductivity for permeation grouting with silica gel grout: 10^{-2} cm/sec.
- *“The generally accepted rule of thumb, based on history, is that one to two orders of magnitude of hydraulic conductivity reduction is possible and 1×10^{-5} cm/ sec is the lowest practically achievable hydraulic conductivity with sodium silicate grout.” (page 4-20).*
- Viscosities of typical grouts (Powers Figure 22.10)
- Typical properties of Sodium Silicate (Powers Table 22.3)
- Grout characteristics: Liquid State vs. Hardened State (Powers Table 22.3)
- Sodium Silicate Viscosity Relative To Water At Various Concentrations (Powers Table 22.4)
- Range of Typical Permeating Grout Pipe Spacing in Soil: Fine Sand: 2.6 to 4.3 ft; Sand, sand and gravel: 3.3 to 6.6 ft; Gravel: 6.6 to 13.2 ft/
- Viscosity vs. time behavior of a sodium silicate grout (Powers Figure 22.12)
- Setting time of sodium silicate grout with di-ester hardener (Powers Figure 22.13)

- Gallons of grout per vertical foot vs. radius of grout spread (Powers Figure 22.32)
- Sodium silicates are the most commonly used grouts.
- Acrylates are recent substitutes for acrylamide grouts where toxicity concerns resulted in a sharp decline in application in the 1970s. Acrylate grouts have very low viscosity (2-3 cP) but require the mixing of up to five different compounds, making application more complicated.

Table 5.1: Applicability of Various Water Tightening Grouts vs. Hydraulic Conductivity (Powers et al., 2007).

(Silica Gel Bolded)

	Range of Application Hydraulic Conductivity (cm/sec)	Notes
Clay-cements	1×10^{-1} to 1×10^2	
Silica Gel (Concentrated)	5×10^{-4} to 5×10^{-2}	<i>Lower range may be limited by cost</i>
Silica Gel (Low Viscosity)	1×10^{-4} to 1×10^{-2}	
Acrylate Grouts / Acrylic Resins	1×10^{-5} to 1×10^{-3}	

The next most important reference is Karol (2003) which has a number of photos, design charts, and results of key grouting research from this period. This reference states that silica gel grouts are expected to have a 50-year lifetime. Berry (2000) provides good rules of thumbs and design charts about the design porosity for grouting; this reference indicates that most sands in the saturated zone will have a “wet-packed” porosity between 24% and 44%.

Solutions-IES tested several amendments to create a vegetable-oil formulation. Selection criteria for the formulation were as follows:

- low cost;
- easy to inject;
- reduces K of sand by at least a factor of 10, preferably a factor of 100;
- persistence in the subsurface greater than typical vegetable oils; and
- slowly ferments enhancing reductive dechlorination.

Amendments considered included: thixotropic emulsion, hydrogenated oils, divalent salts of long-chain fatty acids, and mixtures of emulsified vegetable oil (EVO), sodium silicate (NaSi) and dibasic ester (DBE).

Mixtures of EVO, NaSi, and DBE were identified as having the best potential for field application based on ease of injection, ability to reduce formation permeability, and cost. Based on this screening, several different combinations of EVO, NaSi and DBE were selected for further evaluation.

Silica Gel Grout – (Small-Scale Demo Cell Type 1)

In the most common type of permeation grouting performed by geotechnical contractors, sodium silicate grout, a low-viscosity fluid containing SiO₂, is mixed with a hardening agent prior to being injected in the subsurface. The electrolyte/reagent enables the process of gelation (solidification) in the soil, forming an impermeable barrier in the subsurface (Moridis et al., 1997, Truex, 2011). Gelling times can be controlled based on the volumetric ratio of silica gel to reagent / electrolyte solution and can also be influenced by pH, salinity of water, and temperature (Powers et al., 2007).

Key properties of sodium silicate for this type of application include the following:

- i) This material has been used for decades, and the handling and application properties are well known.
- ii) It is chemically benign, thereby posing no environmental hazard;
- iii) It has a controllable gel time (one hour or less) that is compatible with subsurface injection processes and can be adjusted based on site-specific considerations;
- iv) It is easy to inject with standard equipment, with typical spacing of 0.8 to 2 m (2.5 to 6.5 ft) in sandy soils (Powers et al., 2007).
- v) It forms durable barriers after gelation is complete in the subsurface (Kim and Corapcioglu, 2002).
- vi) It is resistant to both chemical and biological degradation (Moridis et al., 1999).

In order to ensure that the sodium silicate grout mix applied in the field demonstration will be effective, a number of preliminary lab tests were conducted at GSI Environmental's field office in Houston. These lab tests included the selection of a sodium silicate grout mix, as well as the testing of field equipment for the installation and monitoring of injection fluids.

Powers et. al, 2007, suggest that lower concentrations of sodium silicate as compared to standard permeation grouting applications can achieve lower viscosities while providing the water tightening that is required for this barrier application.

As such, the gel times of 12 grout mixes consisting of a mixture of 10-30 v% of sodium silicate with two different hardening reagents: i) 1-3 v% of calcium chloride and ii) 2-5 v% of dibasic ester (DBE) were tested. Both of these reagents are commonly used in geotechnical practice for hardening silica gel for "geotechnical water tightening" projects.

The selection criteria for the grout mix that was selected for the Small-Scale demonstration is as follows:

- i) viscosity of approximately 2-5 cP to allow for penetration in lower-permeability silty soils (Karol, 2003);
- ii) gel time of 3-5 hours.

The final selected formulation consisted of: 10 vol-% of sodium silicate, 5 vol-% of dibasic ester hardener, and 85 vol-% of water. This formulation had a gel time of approximately 4 hours and had an estimated viscosity of 3-4 cP.

Novel Silica Gel/Veg-Oil Grout – (Small-Scale Demo Cell Type 2)

Solutions-IES conducted a series of laboratory studies to evaluate the best candidate novel grout based on silica gel and veg oil. These tests included:

- 1) test of the application rate required to achieve the desired reduction in K;
- 2) injection tests to evaluate the ease of distribution in one-dimensional columns; and
- 3) fermentation tests to measure gas production over time.

The final selected formulation consisted of: 5 wt-% of emulsified vegetable oil (EVO), 10 wt-% of sodium silicate, 1.8 wt-% of dibasic ester, and 83 wt-% of water (Borden et al., 2014).

For Cell Type 2, a novel vegetable-oil based formulation, developed by Solutions-IES was tested. Key properties of this material are (Appendix C):

- i. It provides a slow-release electron donor in the barrier, potentially increasing the performance and flux reduction associated with the barrier;
- ii. It has a very long gel time, which may make injection easier, but may be a problem in more permeable formations, as the gel may “run” and not properly set up to form a good vertical barrier;
- iii. The long-term persistence of the material is not known.

The final selected formulation consisted of: 5 wt-% of emulsified vegetable oil (EVO), 10 wt-% of sodium silicate, 1.8 wt-% of dibasic ester, and 83 wt-% of water (Borden et al., 2014).

This formulation provided a 3-4 orders of magnitude reduction in lab permeability tests, had a gel time of 18 hours, and the addition of EVO is expected to enhance long-term biodegradation of anaerobically biodegradable contaminants (Borden et al., 2014).

5.1.2 Task 2: Small-Scale Demonstration

For the Small-Scale Demonstration four circular treatment cells (two each for the silica gel and two for the silica gel/veg oil material) were constructed in four separate injection points consisting of multi-depth injection wells (Section 5.3.2);

Figure 5.1A below shows the conceptual layout of the Small-Scale demonstration, while Figure 5.1B and Section 5.2 shows the conceptual field design where grouting material was injected into each of the four injection points followed by clean chase water to construct a round donut shaped barrier.

A pumping extraction test was conducted at each of the four injection points before the barrier installation in order to determine baseline aquifer characteristics. After injection of grout and establishment of treatment barriers, groundwater flow into the treatment cell was reduced.

Post-barrier pumping tests were used to determine the reduction in aquifer transmissivity in each cell, and ultimately, the effectiveness of the groundwater flow barrier.

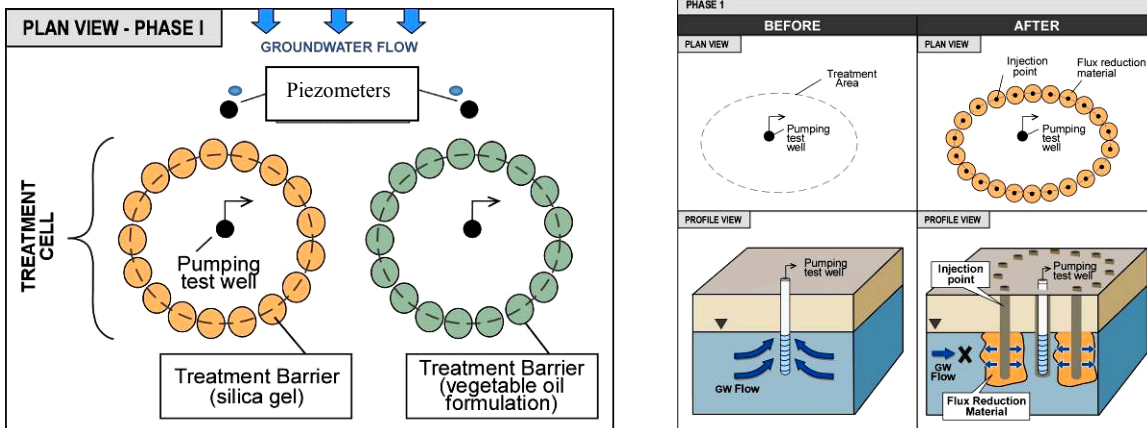

Figure 5.1A: Conceptual Layout of Small-Scale Field Demonstration, Plan View (left) and Flux Reduction (right)

See Section 5.2 for Final Design

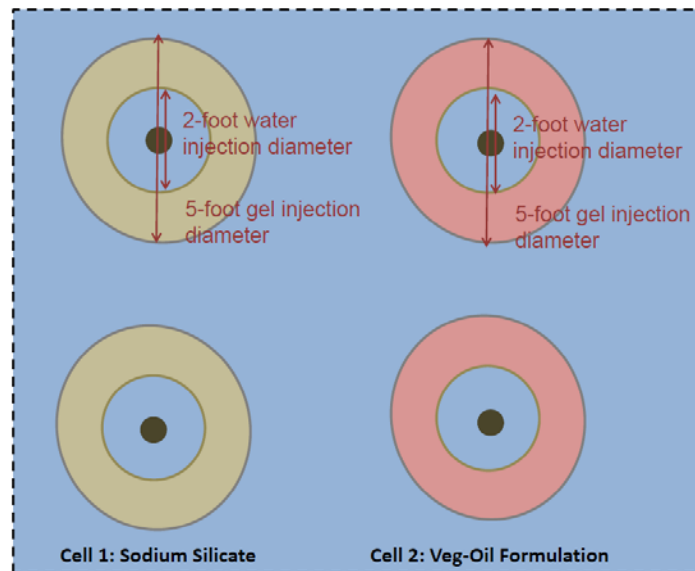

Figure 5.1B: Actual Field Design Configuration

5.1.3 Task 3: Large-Scale Demonstration

If the performance objectives for the Small-Scale Demonstration were achieved, the Large-Scale Demonstration was to be performed. Figure 5.2 shows a conceptual figure of the Large-Scale Demonstration, groundwater flow carrying competing electron acceptors will be diverted from the treatment area, creating an anaerobic, enhanced biodegradation treatment zone.

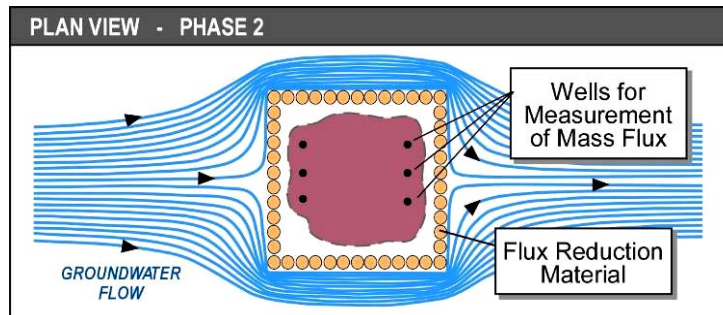

Figure 5.2: Large-Scale Field Demonstration, Plan View

The conceptual design for the Large-Scale Demonstration included six monitoring wells in order to:

- i) measure change mass flux using Passive Flux Meters in three wells before and after barrier construction, and
- ii) measure change in hydraulic gradient before and after the barrier in 3-pairs of wells.

In addition, a limited groundwater flow modeling study of the performance of different barrier configurations was performed using MODFLOW. The model runs assumed:

- Hydraulic conductivity of the formation: 1×10^{-2} cm/sec
- Hydraulic conductivity of the barrier wall itself (1×10^{-5} cm/sec) (a conservative value; see right hand column of Table 5.1)
- Wall thickness: ~3 feet
- Hydraulic Gradient: 0.006 ft/ft

The base case, a four sided barrier, was predicted to achieve a 97% reduction in groundwater flow through the barrier based on counting the groundwater streamlines (Figure 5.3a, top panel). Three sided barriers showed a significant reduction in performance: a barrier aligned with groundwater flow with the opening facing downgradient showed only an 80% flow reduction (Figure 5.3a, bottom panel). A side-open barrier and diagonal barrier showed similar performance as the downgradient barrier: 83% and 74% respectively although there was some subjectivity in which streamlines to count. Overall the modeling study suggested that four-sided barriers are likely required for good flow reduction, and three-sided barriers are much less effective.

Site experience also indicates that “hanging walls” (barriers that are not keyed into a low permeability zone on the bottom), will have much poorer performance than walls that do have a low permeability bottom.

Additionally, continuous water level measurements was to be recorded by installing a pressure transducer in a well inside the barrier, and another in a well outside the barrier.

In addition, two technical questions were asked by ESTCP:

Question 1: It seems possible that by blocking groundwater flow to part of an aquifer, there may be unintended consequences to the surrounding area. Please discuss potential side effects of this technology and how they may be assessed during the demonstration.

Question 2: Will there be more potential for vapor intrusion if the technology is implemented under an active building?

Additional studies and calculations were conducted to carefully study these issues. In both cases the analysis indicated that a groundwater barrier is not likely to cause problems from changing groundwater flow patterns or from potential vapor intrusion. The detailed explanations are provided in Appendix D.

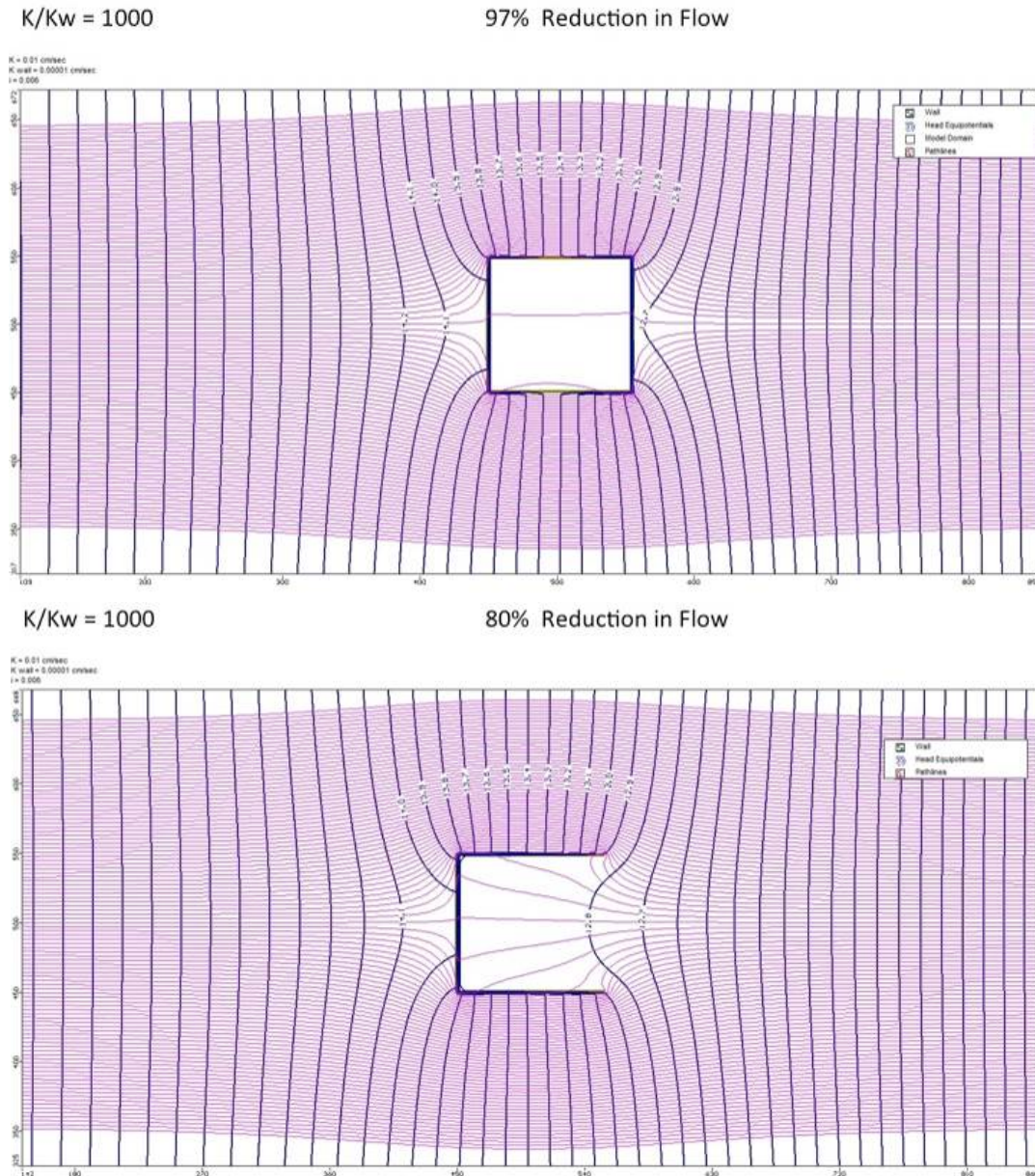
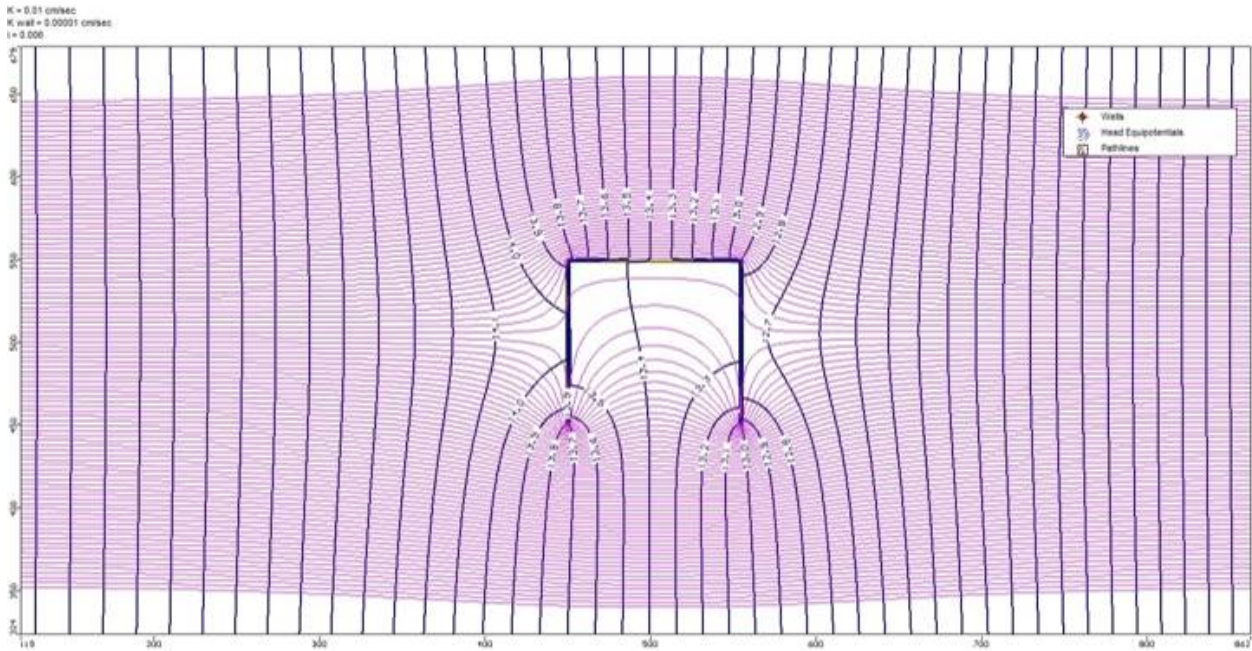

Figure 5.3A: MODFLOW Groundwater Flow Modeling Showing Streamlines Around 4-Sided Barrier (Top Panel) And Three-Side Barrier With Opening Facing Downstream (Bottom Panel) and Percent Flow Reduction Through Interior of Barrier

Model Assumptions: K formation: 1×10^{-2} cm/sec; K wall itself (1×10^{-5} cm/sec); Hydraulic Gradient: 0.006 ft/ft.

$K/K_w = 1000$

~83% Reduction in Flow



$K/K_w = 1000$

~74% Reduction in Flow

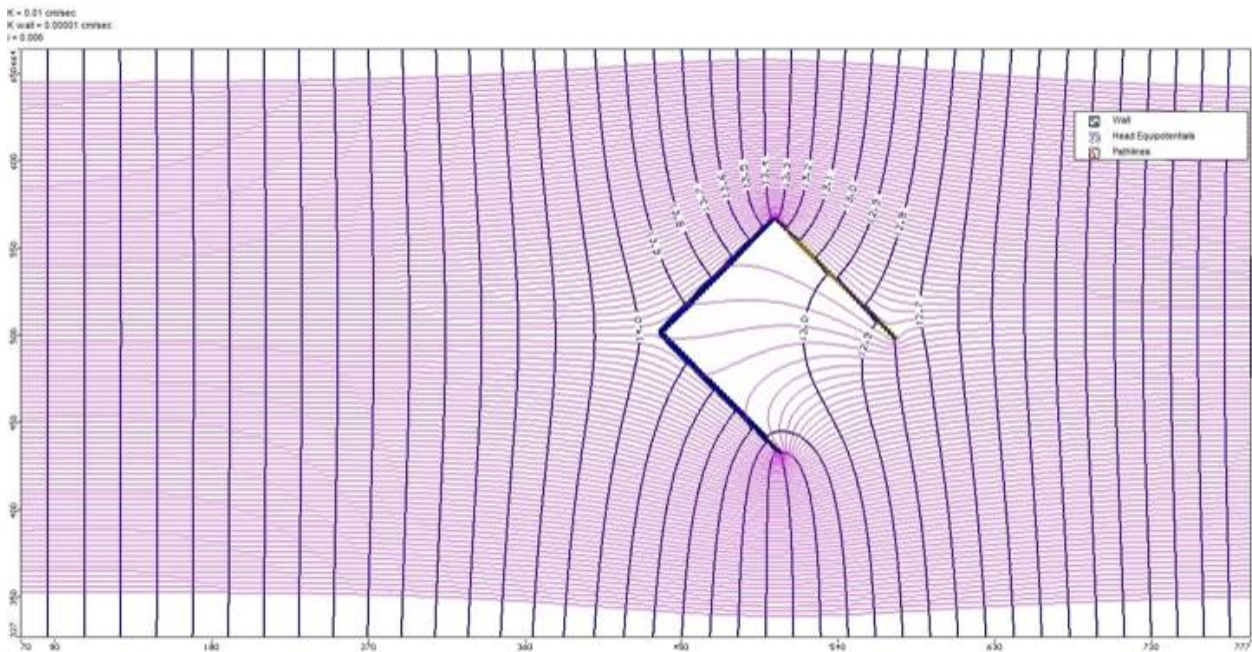

Figure 5.3B: MODFLOW Groundwater Flow Modeling Showing Streamlines Around 4-Sided Barrier (Top Panel) And Three-Side Barrier With Opening Facing Downstream (Bottom Panel) and Percent Flow Reduction Through Interior of Barrier

Model Assumptions: K formation: 1×10^{-2} cm/sec; K wall itself (1×10^{-5} cm/sec); Hydraulic Gradient: 0.006 ft/ft.

5.2 BASELINE CHARACTERIZATION ACTIVITIES

5.2.1 Small-Scale Demonstration

The goal of the Small-Scale demonstration was to assess the reduction in transmissivity across a barrier created using two different flux reduction materials. As such, the baseline characterization activities included baseline aquifer transmissivity assessment using extracted groundwater volume.

Baseline Aquifer Transmissivity

The low transmissivity of the formation at the test site made evaluating the change in transmissivity more challenging. Conventional constant rate pump tests are difficult to implement in low permeability formations because wells can go dry and complicate the analysis of the data. Because it will be difficult to anticipate a constant pump rate test will succeed at the site, the relative change in before-and-after transmissivity was evaluated by two methods: 1) comparing the total volume of groundwater pumped from the formation at each location before and after the barrier installation; and 2) performing constant head injection tests (with injection rather than groundwater extraction).

For the extracted volume test, peristaltic pumps were operated in each injection depth of each multi-well injection point for a total of four hours. The pump intake tubing was placed in the middle of the screened interval and pumped at a flowrate where it was expected to draw down the water in the well to the pump intake. For the constant head injection tests, three injection depths at each multi-level well in the saturated zone were equipped with injection well heads and connected to the water storage vessels with garden hoses. The constant head injection tests were operated for a total of five hours at each well.

The groundwater recovered during the pumping tests was stored and tested, and disposed of in a manner amenable to the Navy project manager.

5.2.2 Large-Scale Demonstration

The Large-Scale demonstration was not performed because the performance metrics established for the Small-Scale Demonstration were not achieved. The general site characterization strategy to measure the performance of the Large-Scale Demonstration is provided below in the event barrier-type technology is used by other groups in the future.

Mass Flux Measurements (Before)

The mass flux of contaminants from a plume before and after barrier construction can be measured directly using Passive Flux Meters (PFMs) installed in observation wells located inside the treatment barrier. Passive Flux Meters consist of a tube filled with a sorbent/tracer mixture and are inserted into groundwater monitoring wells where they intercept groundwater flow. After several weeks of exposure to groundwater flow, the flux meters are removed from the well, and the contaminants are extracted from the sorbent is extracted. By measuring the amount of tracer leached from the PFM, as well as the amount of contaminant retained in the sorbent, both the concentration of groundwater contaminants as well as the groundwater Darcy velocity can be determined (Hatfield, et al., 2004; Annable, et al., 2005).

One key consideration is that for very low flowrates, the vendor (EnviroFlux) can provide guidelines on the length of time that the PFMs should be deployed and the specific tracers that should be used. While two weeks is typical for most sites, the installation of a low permeability barrier will likely result in lower groundwater flowrates than typically found at most sites. For the Large-Scale Demonstration, a four-week deployment time was recommended for both the before-barrier and after-barrier installation. Since installation of the barrier can take several weeks, the results of the before-barrier PFM testing can be used to guide the deployment time and other design features of the post-barrier PFM deployment.

Water Level Measurements (Before)

The groundwater elevations inside the barrier can be measured to determine the change in the hydraulic gradient before and after the barrier installation. Additionally, pressure transducers that measure and record water levels over time will be installed in several wells to provide more detailed record of the change in hydraulic conditions due to barrier construction.

Groundwater Analysis (Before)

Geochemical parameters such as dissolved oxygen, nitrate, sulfate, and oxidation reduction potential (ORP) can be measured after sufficient time has passed over (likely several months or longer) to determine the effect of groundwater diversion due to the barrier. One approach is to use the pre-installation groundwater velocity and location of the monitoring wells inside the barrier to perform the post-installation measurements of groundwater geochemistry using this formula:

$$\text{Minimum time before making geochemistry measurement:} = \frac{\text{Distance from well to upgradient location of boundary}}{\text{Pre-installation groundwater seepage velocity}}$$

5.3 TREATABILITY OR LABORATORY STUDY RESULTS

Silica Gel Grout

Gel tests were conducted at GSI Environmental in order to ensure: i) the proper selection of flux reduction material with an appropriate gel time, and ii) effective flow measurement methods. The selection criterion for this grout mix was as follows:

- i) viscosity of approximately 2-5 cP to allow for penetration in lower-permeability silty soils (Karol, 2003);
- ii) gel time of 3-5 hours.

Results of these lab tests were applied to the implementation of the field program at the site. Gel Tests included:

- i) Measurements of gel times and viscosities of various grout mixes composed of sodium silicate and two different hardeners (CaCl₂ and dibasic ester (DBE));
- ii) Multiple methods of measuring flow rate;
- iii) Testing the feasibility of cleaning out different pieces of equipment once grout has gelled inside them.

As such, the gel times of 12 grout mixes consisting of a mixture of 10-30 v% of sodium silicate with two different hardening reagents: i) 1-3 v% of calcium chloride and ii) 2-5 v% of dibasic ester (DBE) were tested. Both of these reagents are commonly used in geotechnical practice for hardening silica gel for “geotechnical water tightening” projects.

To test the gel time, the technical team mixed each of the mixes into a 40 mL vial and timed to see how long it took for the liquid solution to solidify into a gel. The target gel time was 3-5 hours. For the flow rate experiments, a number of different methods of measuring flow were tested, in order to determine which was the most feasible for use in the field. Measurement methods tested included: ultrasonic flow meter, the injection of food dye, the injection of an air bubble, and measuring the rotational speed of a flow indicator.

Finally, for the cleaning experiments, a number of pieces of equipment were filled with grout mix, which were allowed to gel and then attempt to clean out using water, water with detergent, and a power washer.

Grout mixes using calcium chloride were found to be ineffective and inconsistent in gel times and proper gelling. As such, only inorganic sodium silicate hardeners were considered for the final phase of testing.

The final phase of testing involved a combination of N Sodium Silicate (10-30%) and dibasic ester (DBE) (1-5%).

The final selected formulation consisted of: 10 vol-% of sodium silicate, 5 vol-% of dibasic ester, and 85 vol-% of water. This formulation had a gel time of approximately 3-4 hours and had an estimated viscosity of 3-4 cP.

Novel Silica Gel/Veg-Oil Grout

Solutions IES designed and tested a novel silica gel/vegetable oil grout as described in Appendix C.

The final selected formulation consisted of: 5 wt-% of emulsified vegetable oil (EVO), 10 wt-% of sodium silicate, 1.8 wt-% of dibasic ester, and 83 wt-% of water (Borden et al., 2014). This formulation provided a 3-4 orders of magnitude reduction in lab permeability tests, had a gel time of 18 hours, and the addition of EVO is expected to enhance long-term biodegradation of anaerobically biodegradable contaminants (Borden et al., 2014).

5.4 DESIGN AND LAYOUT OF TECHNOLOGY COMPONENTS

5.4.1 Injection Skid Design

A skid-based delivery system was designed and was constructed to inject chemical grout to the subsurface. The skid included pumps, tanks, mixers, controls, and piping to facilitate mixing of the selected grout components prior to injection into the subsurface via injection points. The Injection Skid Design Manual is provided in Appendix E.

Design Requirements

The skid was designed to address the overall objective of the system and to accommodate the following design basis parameters, assumptions, and limitations:

- **Phased Approach to Work:** Work to be conducted in two phases, Phase 1 (Small-Scale Demonstration) and Phase 2 (Large-Scale Demonstration). Phase 1 included testing of two optional grout mixes. The skid must be usable for both phases and for testing both options during Phase 1.
- **Total Injection Volumes:** Skid components, especially tanks and pumps, must be conveniently sized and capable of injecting within a reasonable timeframe.
- **Injection Pressures:** The skid was designed to deliver chemical grout at injection pressures ranging from 3.8 to 38 psi, corresponding to 8.7 to 87 ft of H₂O (Table 5.2). Typical maximum injection pressures for chemical grouting are set at approximately 1 psi/ft of overburden (Karol, 2003). For some waste injection applications, regulatory authorities may limit the injection pressure to 25% of this amount (RRC, 2014). However, given that some consider the 1 psi/ft of overburden to be overly conservative (Powers et al, 2007); a range bracketing the 1 psi/ft of overburden has been selected as a preliminary design criterion. Therefore, to provide flexibility for testing in the field, the skid was capable of delivering grout under a range of 75% to 125% of the overburden pressure. For the anticipated injection depths of 5 to 30 ft below ground surface (bgs), estimated grout delivery pressures were as follows:

Table 5.2: Determination of Injection Pressures

Maximum Injection Pressure Recommended	Injection Depth	Injection Pressure	
75% psi/ft of overburden	5 ft	3.8 psi	8.7 ft H ₂ O
	30 ft	22.5 psi	52 ft H ₂ O
125% psi/ft of overburden	5 ft	6.2 psi	14 ft H ₂ O
	30 ft	38 psi	87 ft H ₂ O

- **Injection Configuration:** To ensure efficient and cost effective barrier construction, grout mixture was injected simultaneously via a manifold into a maximum of 12 locations and/or depths (i.e., 3 injection points with 4 depth levels per injection point). The 12-branch manifold had the operational flexibility to conveniently change or terminate injection at any individual location and/or depth while continuing injection at other individual locations and/or depths.
- **Injection Flow rates:** The skid was capable of delivering a total of 1 to 15 gpm of grout, corresponding to 0.1 to 1.2 gpm per individual location and/or depth. Actual delivery rates depended on the rate of the subsurface formation to accept the grout.

- **Grout Mixtures:** The skid was capable of pumping, mixing, and injecting the grout mixtures currently under consideration, including sodium silicate with or without emulsified vegetable oil (EVO) and dibasic ester (DBE). Concentrations of grout components currently under consideration to be delivered by the skid are as follows (Table 5.3):

Table 5.3: Grout Mixtures

Phase	Sodium Silicate	EVO	DBE	Water
Small-Scale Demo: Conventional Silica Gel	10 vol%	None	5 vol%	85 vol%
Small-Scale Demo: New Silica Gel/EVO Material	7 vol%	5 vol%	2 vol%	86 wt%
Large-Scale Demo	To be determined			

- **Skid Operation:** The skid was manually operated and controlled. The measurements obtained from any instruments (e.g., pressure gauges, flow indicators) were directly read from the instrument. Piping and valves were configured and labeled to facilitate understanding of how the flow is being routed at any time (e.g., from water supply to dilution tank, from dilution tanks to manifold, etc.).

Process Flow

Description and Process Flow through Major Skid Components

A simplified process flow diagram (PFD) for the overall injection system is shown in Figure 5.4. Each component is described in additional detail below:

- **Water:** Clean potable water was obtained from an off-site company and delivered to the site in a poly-tank.
- **Grout Component Preparation:** In order to prepare the grout components for injection, concentrated NaSi (with or without EVO) and DBE were transferred from the drums or totes delivered to the site (i.e., Tanks T-01 and T-03, respectively) for dilution in two larger tanks (i.e., Tanks T-02 and T-04, respectively). Dilute NaSi (with or without EVO) was prepared by filling Tank T-02 with a sufficient volume of water and NaSi (with or without EVO) to attain the specified dilution. Dilute DBE was prepared by filling Tank T-04 with a sufficient volume of water and hardener to attain the specified dilution. Concentrated grout components were pumped to the tanks by means of centrifugal pumps (P-02 and P-03).

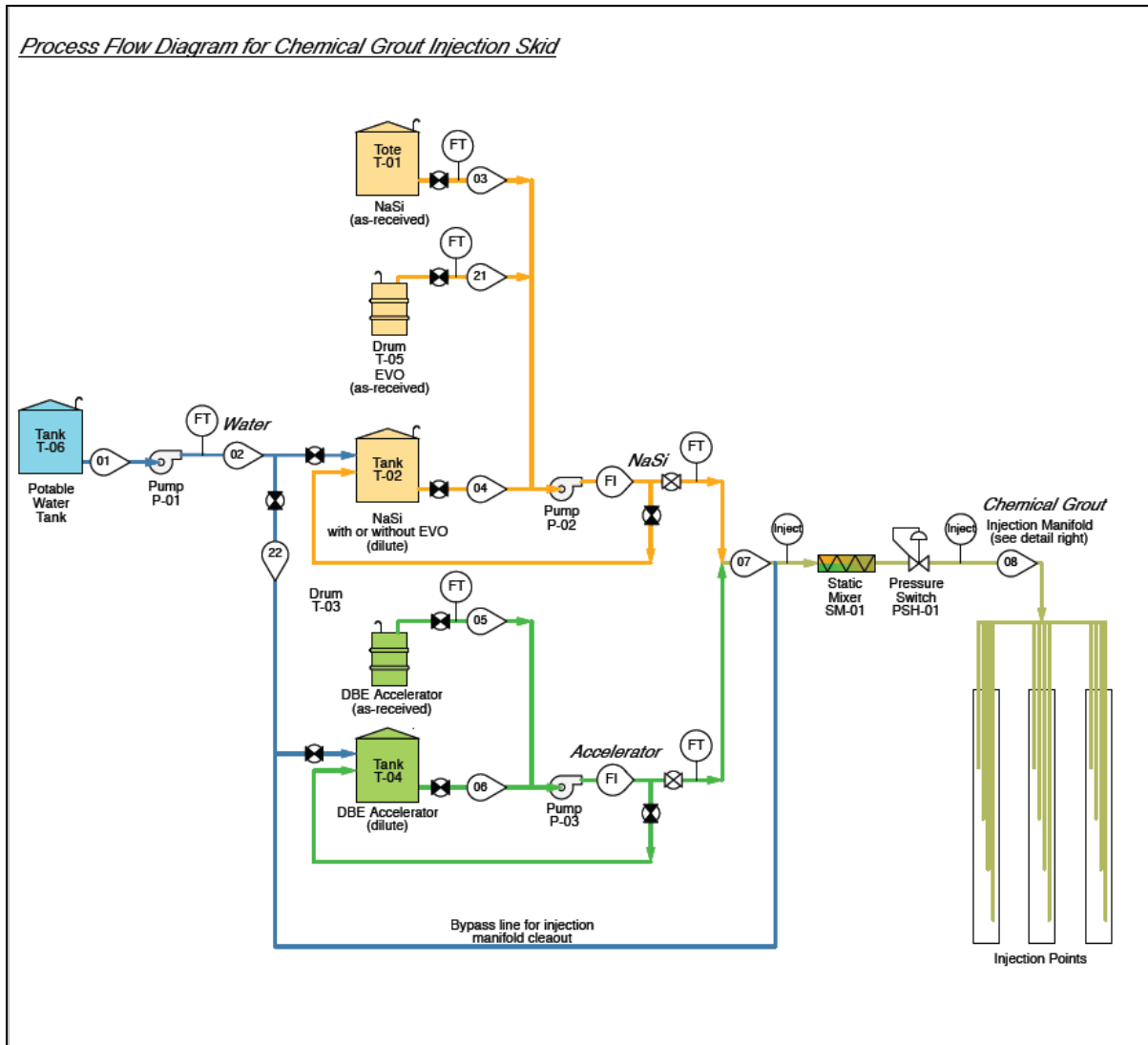

Figure 5.4: Process Flow Diagram for Chemical Grout Injection Skid

- **Tanks for Grout Components:** Tanks T-02 and T-04 were used for mixing each component with water to create a dilute mixture. These tanks were approximately 750 gallon capacity.
- **Mixing of Grout Components:** In addition to being used to transfer the as-received grout components to the dilute tanks, Pumps P-02 and P-03 were also used to recirculate dilute tank contents in order to promote mixing, and deliver the dilute grout components to a 6-element, 0.75-in diameter static mixer. Shut-off valves were opened and closed as required to route the grout components to tanks or the static mixer as required for the particular stage of the preparation or injection process.
- **Pressure Regulation:** A pressure switch (PSH-01) was used to regulate the pressure downstream of the static mixer to ensure a constant pressure to the injection manifold. The injection skid was designed to shut off if the maximum pressure is met or exceeded. This pressure threshold was adjustable in the field.

- **Injection Manifold:** A manifold for delivery of the grout mixture to the injection points is described in additional detail below.

Description and Process Flow through Injection Manifold

Details of the injection manifold are depicted on the PFD shown on Figures 5.5 and 5.6. As noted above, the grout mixture flowed under constant pressure to the manifold, then into 12 branches of the manifold, and then to the injection points. The manifold and branches were constructed of PVC, and the individual lines were constructed of 0.5-in diameter, clear, flexible tubing. Each branch was equipped with a pinch valve, an injection point for water, a pressure gauge, flow totalizer, and a sight flow indicator. Flow rate of the grout in each branch was measured quantitatively using a flow totalizer which was placed on the outside of the piping and moved from branch to branch of the manifold.

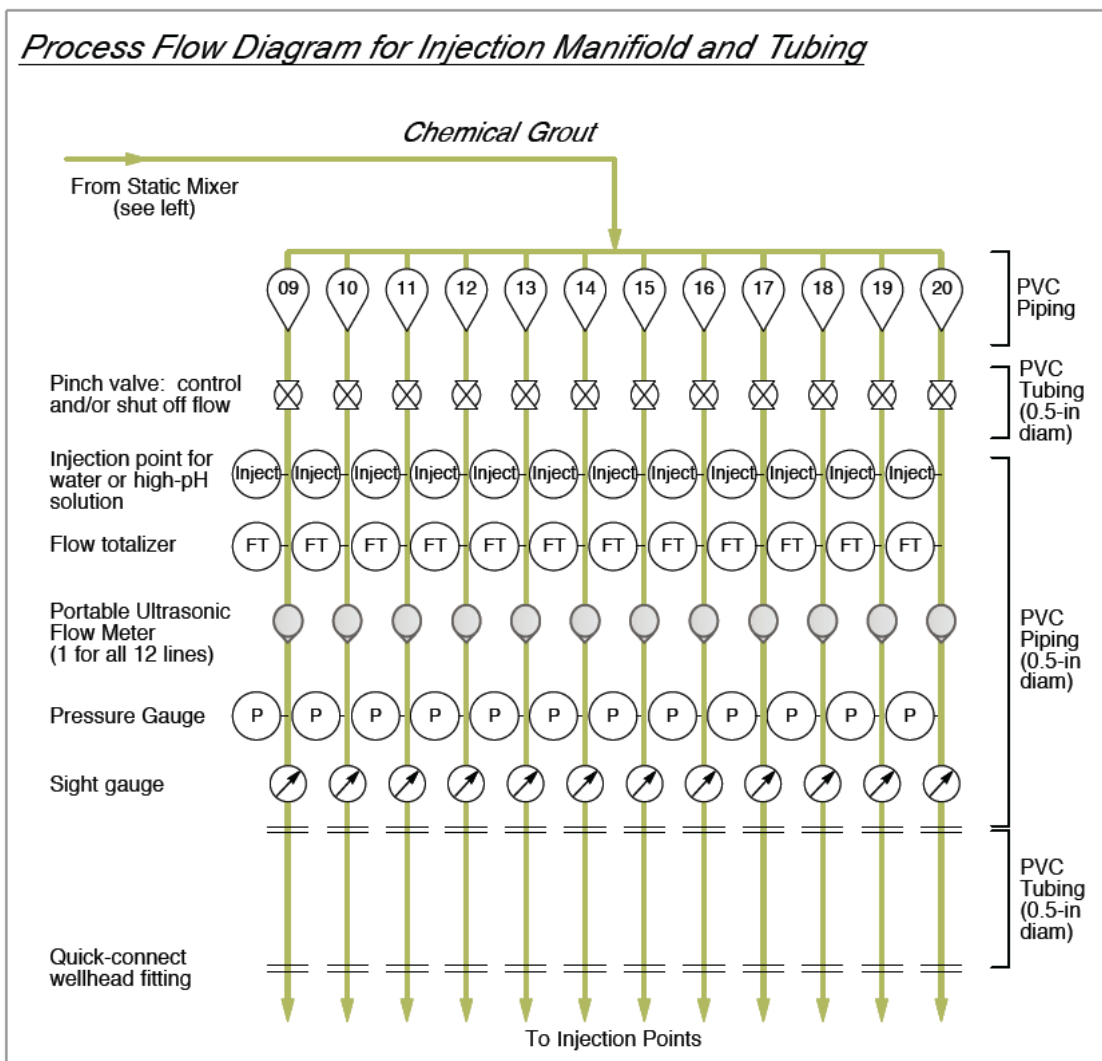

Figure 5.5: Process Flow Diagram for Injection Manifold and Tubing

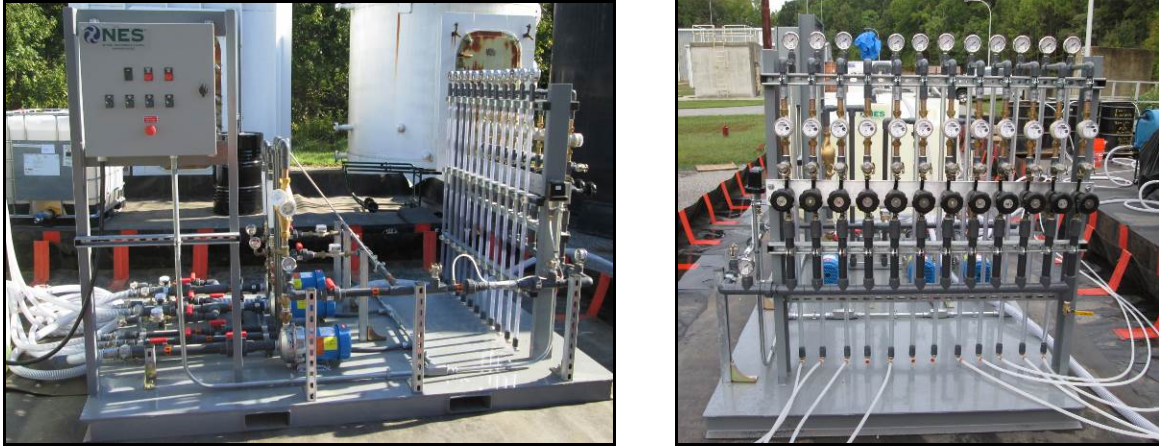

Figure 5.6: Injection Skid (Left) and Injection Manifold (Right)

Measures to Address Potential Clogging of Manifold and Tubing

Clogging could potentially occur within the static mixer, manifold, branches, and tubing downstream of the tee where the NaSi (with or without EVO) and accelerator come together if the residence time within the piping exceeds the planned set time of 3-4 hours. The following design considerations were implemented to deal with potential clogging:

- ***Minimize Number of Parts Subject to Clogging:*** The grout was mixed at the furthest downstream portion of the skid feasible. In addition, flow rates in the individual branches of the manifold were measured using a totalizer, as well as a meter which does not contact the grout.
- ***Use Inexpensive, Replaceable Parts:*** The static mixer, manifold, branches, and injection lines were constructed of inexpensive PVC pipe and tubing which can be replaced if clogged.
- ***Keep Grout Moving:*** In addition to the quantitative flow rates measured by the totalizers, sight flow indicators provided an immediate and direct indication of whether flow is moving in each individual line. If flow was observed to be slowing in a particular line, flow to the line was shut off and the line moved to another injection location. Additionally, if the injection skid was shut off or injection is stopped for longer than an hour, the injection lines were cleared out with clean water and contained in a drum.

During the grout mixing and injection processes described above, procedures were employed to control the process and collect data. During field work, measurements were recorded on a routine specified basis to characterize the process and to facilitate determining design parameters for implementation of Phase 2 and full-scale design. In addition, specific process variables were measured to identify possible system malfunctions or undesirable conditions. These variables include: flow rates, volumes, and injection pressures.

5.4.2 Small-Scale Demonstration

Injection Points

To ensure a good vertical distribution of grout, multiple nested injection points were used. The vertical barrier was constructed by injecting the reactive grout mix as a liquid into multi-level injection wells. Figure 5.7 shows the injection well design. To ensure good vertical placement of the grout, four injection intervals will be used, each served by a 0.5 inch diameter PVC injection well or injection tubing. The conceptual figure below shows a well with a 20-foot thick injection zone. Figure 5.8 shows the plan view of the multi-level injection well.

The injection well system was designed to allow for repeated rapid placement without the need for individual geologic logs at each injection point. Because of the heterogeneous nature of site geology, it was anticipated some of the injection points will likely contact clay and will likely not accept any grout. As these units already have a low permeability, this will not compromise the performance of the barrier. The goal was inject grout in the mobile porosity, primarily the sands and more permeable silts that intersect the flux reduction barrier.

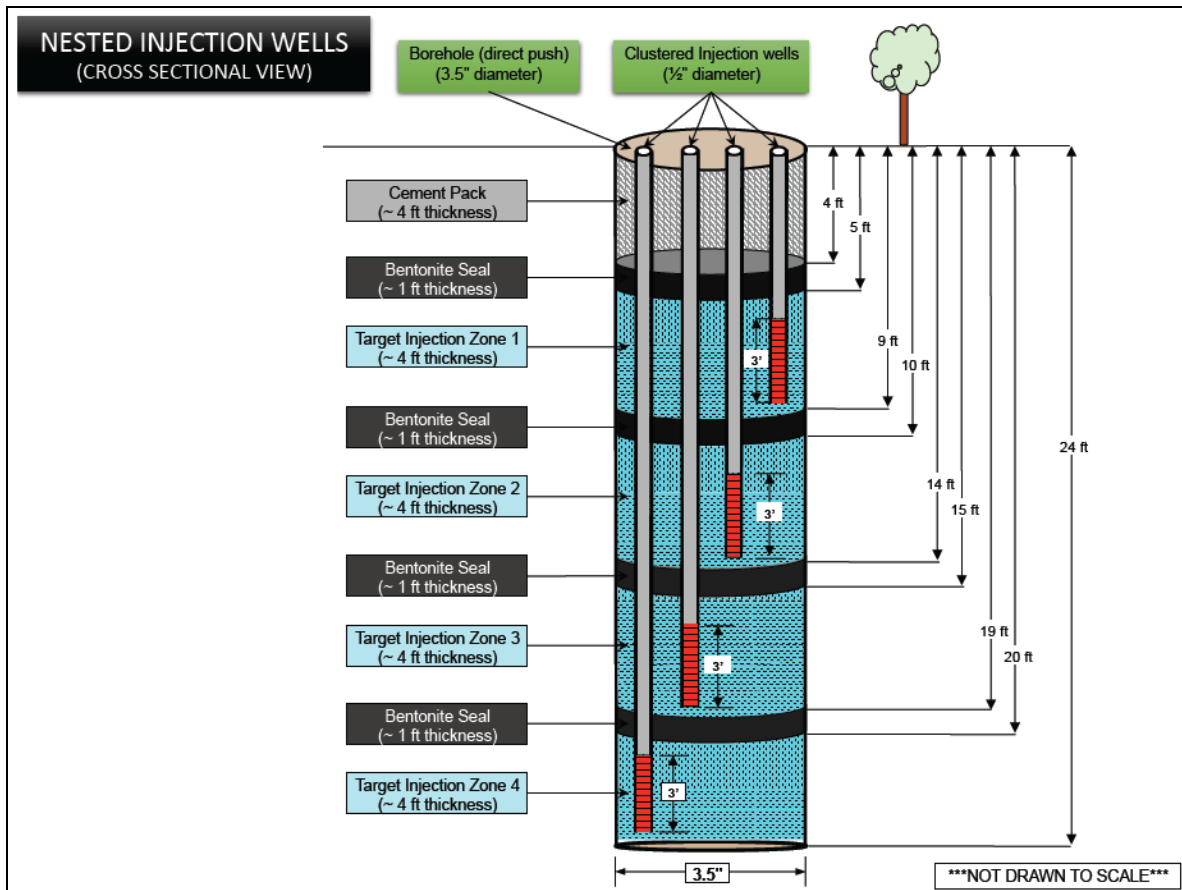

Figure 5.7: Conceptual Diagram of Direct Push Multi-Level Injection Wells With Four Separate Injection Zones

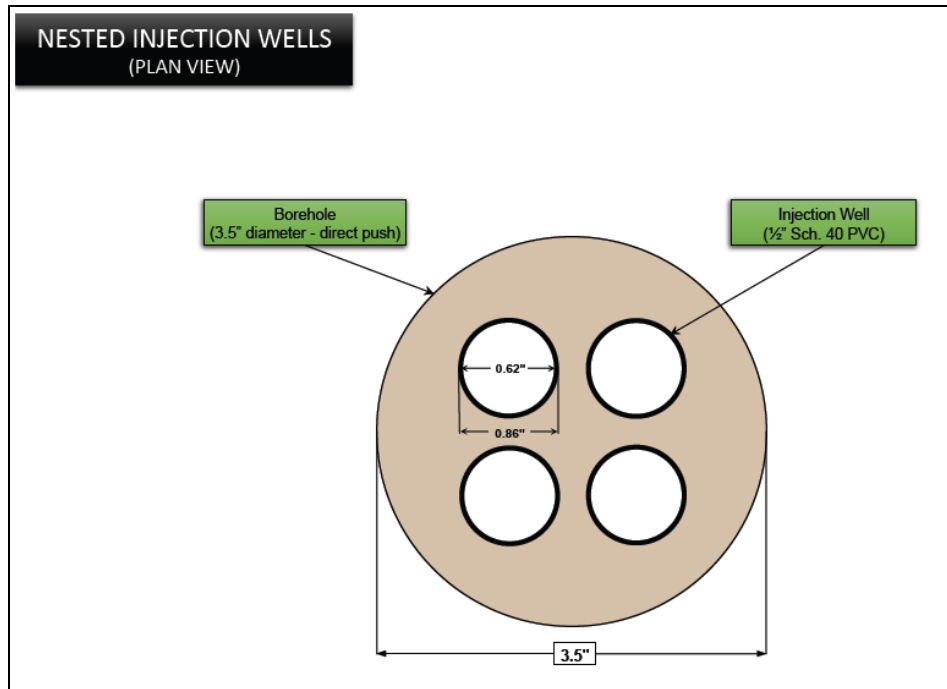

Figure 5.8: Plan View of Multi-Level Injection Well Design

Installation of Treatment Cell Barriers

Each cell in the Small-Scale demonstration was constructed in the configuration shown in Figure 5.9 below.

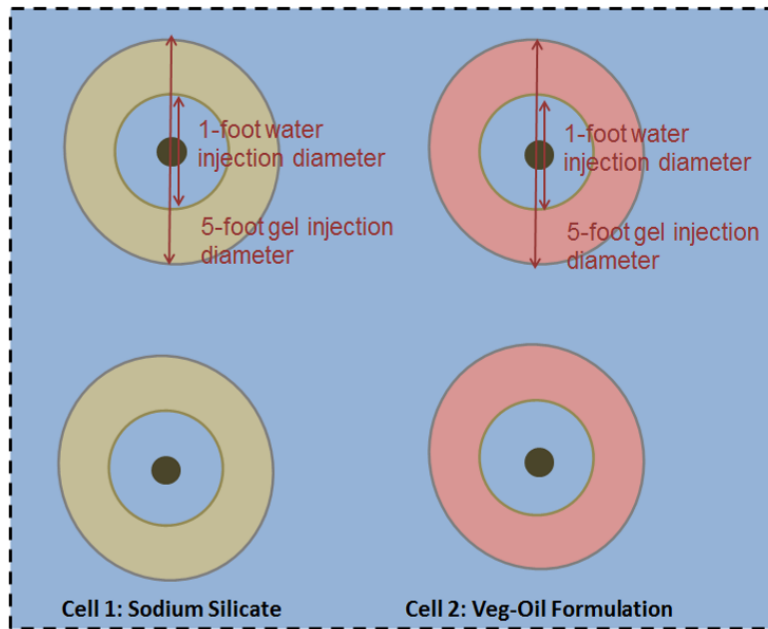

Figure 5.9: Small-Scale Demonstration Configuration

Two conventional sodium silicate grout barriers around two of the wells and two veg-oil formulations grout barriers were designed. The barriers were constructed by first injecting several hundred gallons of grout in liquid form; because the grout takes several hours to harden, the grout injection would be followed by the injection of clean water to: 1) push the unhardened grout out the ring; and 2) create an untreated zone around the well.

The approximate barrier construction parameters and injection volumes are as follows:

- Treatment barrier vertical depth: ~5 ft bgs to 30 ft bgs
- Approximate thickness of permeable portion of injection points: 10 feet
- Volume of grout mix per injection point: 420 gallons
- Total number of injection points: 4
- Total volume of grout mix: 1680 gallons

As described in Section 5.3.1 (Injection Skid Design), an injection skid was used to mix the chemical grout formulations to the specified concentrations. During the injections, measurements of process variables will be recorded on a frequent basis.

Post-Barrier Aquifer Transmissivity

As described in Section 5.2.1, groundwater was pumped from each pumping or injection well for 4 hours continuously after the installation of the barrier cells.

5.4.3 Large-Scale Demonstration

The Large-Scale demonstration was not performed because the performance metrics established for the Small-Scale Demonstration were not achieved. The general site characterization strategy to measure the performance of the Large-Scale Demonstration is provided below in the event barrier-type technology is used by other groups in the future.

Monitoring Well and Piezometer Installation

Six monitoring wells were to be installed within the treatment barrier in order to assess the change the hydraulic gradient, measure water levels over time using pressure transducers, and obtain replicate mass flux measurements before and after barrier construction.

Additionally, one piezometer was to be installed outside the treatment barrier and will be used to obtain water level measurements using a pressure transducer.

Injection Points

Injection points during the Large-Scale demonstration were to be constructed with injection point spacing and radius of influence diameters (based on complete displacement into the entire pore space) of 4 feet and 5 feet respectively (Figure 5.10).

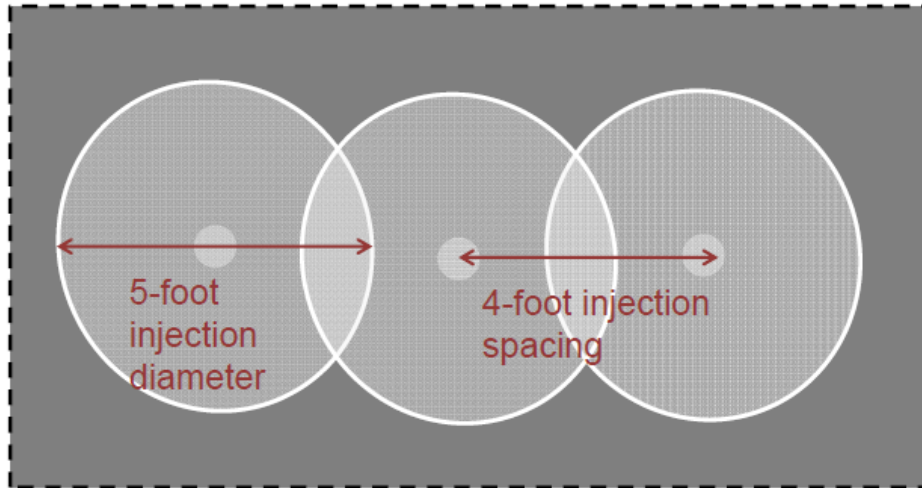

Figure 5.10: Large-Scale Demonstration Injection Points

Installation of Treatment Barrier

The conceptual design for the Task-3 Large-Scale barrier was (assuming 4 foot spacing):

- Spacing between injection points: 4 ft
- Approximate treatment barrier length and width: 40 ft x 40 ft
- Treatment barrier vertical depth: ~3 ft bgs to 20 ft bgs
- Approximate thickness of permeable portion of injection layers: 5 feet
- Volume of grout mix per injection point: 220 gallons
- Number of injection points: 40
- Total volume of grout mix: 8,800 gallons

Post-Barrier Mass Flux Measurements

Mass flux measurements were to be made after the installation of the barrier at the same wells and at the same depths as the baseline mass flux measurements.

Post-Barrier Water Level Measurements

As with the baseline water level measurements, the following data was to be obtained after the barrier construction: i) the groundwater elevations in all inside barrier monitoring wells to determine the hydraulic gradient inside and outside the barrier, ii) groundwater discharge (liters per day) within the treatment zone based on the flux meter Darcy Velocity and the area of the barrier perpendicular to flow (this metric should serve as a secondary measure of groundwater flow reduction after barrier installation), and iii) data from pressure transducers that measure water levels and log data over time in one well outside the treatment zone, and at least one well inside the treatment zone, to see the dynamic change of water levels inside and outside the barrier due to recharge events and water level changes.

Post-Barrier Groundwater Analysis

Geochemical parameters (dissolved oxygen, nitrate, sulfate, and ORP) were to be measured again to determine post-test conditions several months after barrier installation. While only small changes are expected for this phase of the testing because of the low ambient groundwater velocities, measurements were to be taken during both the pre- and post-test events to determine if any changes are apparent in flowing vs. clogged conditions. The Department of Energy's BIOBALANCE Tool (<http://www.gsi-net.com/en/software/free-software/biobalance-toolkit.html>) can be used to estimate the potential increase in rate of degradation of chlorinated solvents within the barrier using hydrogen equivalents for reduction in competing electron acceptors and the corresponding increase in available electron donors.

5.5 FIELD TESTING

The Small-Scale demonstration was conducted in October 2015.

5.5.1 Small-Scale Demonstration

Evaluation of Injection Material and Aquifer Transmissivity Reduction

As described above, the low transmissivity of the water-bearing unit at the test site precluded use of conventional constant rate pumping tests. Instead, two different measurement methods were employed: 1) comparison of how much groundwater could be extracted in 8 hours; and 2) constant head injection tests.

In the first method the key performance metric was the ratio of extracted volumes of water were calculated as follows:

$$r = \frac{V_f}{V_i}$$

where,

r = Ratio of volumes

V_i = Volume extracted before installation of barrier

V_f = Volume extracted after installation of barrier

A lower value of "r" corresponding to better performance of the barrier, with a performance goal of 90% reduction in groundwater flow.

When the first method produced unreliable results, the second method was employed where a constant head injection test was performed and the flow vs. time data were analyzed for each location to yield a hydraulic conductivity. This was compared to slug test values conducted by CH2M-Hill at the existing monitoring well at the site.

Page Intentionally Left Blank

6.0 PERFORMANCE ASSESSMENT

6.1 EVALUATION OF FLOW-REDUCTION MATERIALS

6.1.1 Selection of Two Different Flow-Reduction Materials

As previously discussed, two grout materials were tested: 1) a sodium silicate grout with organic hardener; and 2) the Solutions-IES silica gel/veg oil grout material.

6.1.2 On-Site Gel Tests with Site Soils

On-site gel tests were conducted in order to confirm the selected mixture concentration, as well as assess the impact of site soils and groundwater chemistry on actual gel time (Figure 6.1).

As such, gel tests were conducted with various grout mixture concentrations in VOA vials (without site soil) and small jars (with site soils). Mixtures of the sodium silicate grout consisted of 10% sodium silicate by volume and 1 to 5% by volume of dibasic ester. Mixtures of the vegetable oil formulation consisted of 7.5% sodium silicate by volume, 5.2 % vegetable by volume, and 0.5 to 3% by volume of dibasic ester.

Results of the on-site gel tests indicated that both grout types gelled with site soils, with approximate gel times of 2.5 hrs for the sodium silicate grout and 2.0 hrs for the vegetable oil formulation.



Figure 6.1: On-Site Gel Tests with Site Soils

6.2 INJECTION WELL AND BARRIER CONSTRUCTION

Four injection points were constructed (S-1, S-2, ES-1, and ES-2) in a clear area at Site 17 near Building 1569 (Figure 6.2). Each well was constructed with 2-ft injection zones at depths ending in a clay unit approximately 14.5 ft bgs, 18 ft bgs, 21.5 ft bgs, and 25 ft bgs. Table 6.1 summarizes well construction details for each injection point.



Figure 6.2: Location of the Phase 1 Demonstration at Site 17 at the Indian Head NSF

Table 6.1: Injection Point Construction Details

Well ID	Depth Interval Label	Stickup (ft)	Total Depth (ft btoc)	Screen Interval Length (ft)	Top of Screen Interval (ft bgs)	Bottom of Screen Interval (ft bgs)
S-1	14.5	1.7	16	2	12.4	14.4
	18	1.7	20	2	16.1	18.1
	21.5	1.7	21	2	17.5	19.5
	25	1.7	27	2	23.1	25.1
ES-1	14.5	1.65	16	2	12.8	14.8
	18	1.65	20	2	16.1	18.1
	21.5	1.65	23	2	19.6	21.6
	25	1.65	27	2	23.1	25.1
ES-2	14.5	1.8	16	2	12.0	14.0
	18	1.8	20	2	16.3	18.3
	21.5	1.8	23	2	19.4	21.4
	25	1.8	27	2	23.0	25.0
S-2	14.5	1.65	16	2	12.8	14.8
	18	1.65	20	2	16.0	18.0
	21.5	1.65	23	2	19.6	21.6
	25	1.65	27	2	23.0	25.0

The injection skid as well as the following components were assembled on-site (Figure 6.3): i) associated mixing tanks; ii) tote of sodium silicate; iii) drum of dibasic ester; iv) drum of vegetable oil; v) poly-tank with water; and vi) generator for skid operation.



Figure 6.3: Injection Skid Assembly with all Components

A pre-barrier groundwater extraction test was conducted at all four injection points immediately after construction. The pre-barrier extraction tests indicated that injection point S-1 likely had construction problems that sealed the injection ports that resulted in very low extracted volumes (1.5 gallons in 3 hours). As such, S-1 was abandoned and no injections were done in well S-1.

After the pre-barrier extraction tests, exact mixtures and volumes of the silica gel grout mix were created in the mixing tanks (one for water and sodium silicate or Solutions IES material, and the other for water and dibasic ester). The injection skid allowed for the mixing and injection of the grout mix into multiple depths simultaneously. Table 6.2 below summarizes the injected volume into each interval and injection point, and ranges from 46 to 112 gallons.

Table 6.2: Grout Volumes Injected per Interval

Well ID	Depth Interval Label	Volume Liquid Grout Injected (gal)	Chase Water Injected (gal)
S-1*	14.5	--	--
	18	--	--
	21.5	--	--
	25	--	--
ES-1	14.5	95	5
	18	110	6
	21.5	107	7
	25	105	6
ES-2	14.5	55	7
	18	49	8
	21.5	49	7
	25	46	7
S-2	14.5	99	7
	18	111	8
	21.5	112	9
	25	112	9

*S-1 abandoned due to inability to extract groundwater

6.3 EVALUATION OF REDUCTION OF MASS FLUX

6.3.1 Results: Before/After Extraction Tests

Water levels were measured at all four locations before conducting pre-barrier extraction tests. Peristaltic pumps equipped with manifold were used to pump from each depth simultaneously per Injection Point for 4 hours. Pumping start and pumping end times were recorded, as well as a total volume pumped. Post-barrier extraction tests were conducted in an identical fashion to the pre-barrier tests and were conducted for four hours.

As seen in Table 6.3 below, the pre-Barrier Extraction test indicated very low yield (extraction rate average of ~0.02 gpm per well) from the formation indicating lower permeability than anticipated based on existing hydraulic conductivity data.

The data did not appear to be reliable due to one or more of the following reasons: i) low pre-barrier extraction test volumes; ii) well construction; iii) the low permeability nature of the aquifer; or iv) lack of time for sufficient rebound in the aquifer.

Table 6.3: Volume Groundwater Removed During Pre- and Post-Barrier 4-Hour Extraction Tests

Injection Well	Injected Grout	Pre-Barrier Extracted Volume Total (gal)	Post-Barrier Extraction Volume Total (gal)	Pre-Barrier Extraction Rate (gpm)	Post-Barrier Extraction Rate (gpm)
S-1	None	1.5	--	0.01	--
S-2	Sodium Silicate	13.1	18	0.05	0.08
ES-1	EVO + Sodium Silicate	2.9	5.25	0.01	0.02
ES-2	Sodium Silicate	5.4	7	0.02	0.03

6.3.2 Results: Constant-Head Water Injection Test

Due to the unclear results from the pre/post barrier extraction tests, a constant-head water injection test was conducted in November 2015. The test was conducted to determine the hydraulic conductivity of the aquifer after grout barrier injections.

Pre-Test Reevaluation of MW-3 Slug Test Data

CH2M-Hill (2008) performed four slug tests at MW-3 and estimated the hydraulic conductivity of the formation was in the 0.5 to 1.2 feet per day range with an average of 0.90 feet per day. During the drilling of the Small-Scale Demonstration test wells, new detailed stratigraphic data were available. GSI reanalyzed the data from 2008 assuming: 1) 6 feet of permeable saturated thickness (silt or sand) vs. an original estimate of 15 feet; and 2) confined conditions. The reanalysis with the new data reduced the average hydraulic conductivity of the transmissive zone to 0.63 feet per day.

Constant-Head Test Setup

The constant head pump test (injection test) consisted of injection of water into well clusters located within the previously injected grout barrier to determine the barrier’s effect on the hydraulic conductivity of the aquifer. Water injections were conducted at well clusters ES-1, ES-2, and S-2. Figure 6.2 shows the locations of the well clusters. Three wells within the saturated zone at each cluster were equipped with injection well heads and connected to the water storage vessels with garden hoses (see Figure 6.2 for well head injection assemblies).

To maintain constant-head conditions throughout the duration of the test, the water storage vessels were staged at an elevation of approximately 26 feet above the injection well clusters (see Figure 6.4). The water vessels were located between 90 and 110 feet from the injection wells. To ensure that a constant-head was maintained for the duration of the test the water levels were continually maintained through addition of water to the vessels (see Figure 6.4). The elapsed time of the test and the volume of water injected into each well cluster were recorded during the test. The injection test was conducted for approximately five hours.

Constant-Head Test Analysis and Results

The hydraulic conductivity of the formation within the grout barrier was estimated with the AQTESOLV software using the Jacob-Lohman curve solution to best approximate aquifer parameters (see Figure 6.4 for an example screen shot). As shown below, the constant-head test estimate indicates that hydraulic conductivities of the aquifer within the grout barrier ranged from approximately 0.20 ft/day to 0.27 ft/day. This represents an approximate 64% reduction in the average formation hydraulic conductivities as compared to pre-barrier installation conditions (see Table 6.4 and Figure 6.6).

Table 6.4: Aquifer Hydraulic Conductivities With and Without Barrier

ES: Silica Gel/Emulsified Oil Test Locations. S: Silica Gel Alone Test Locations.

Test Phase	Location	Hydraulic Conductivity (ft/day)
No Barrier*	MW-03	0.84
		0.51
		0.76
		0.42
	Average	0.63
With Barrier**	ES-1	0.20
	ES-2	0.21
	S-2	0.27
	Average	0.23
Average Hydraulic Conductivity Reduction		64%

*From CH2M-Hill, 2008 slug test data reanalyzed to update saturated thickness information.

** From constant head injection tests (see Appendix F)

Although test results indicate a reduction in the hydraulic conductivities of the aquifer there are uncertainties associated with the constant-head test and the interpretation of the test results. In particular, the estimation of the aquifer parameters in AQTESOLV relies on a best-fit approximation of the Jacob-Lohman solution curve to injection test data, which as shown on Figure 6.5 could entail a wide range of estimates. Therefore, the results of the constant-head test should be viewed as best guess estimates based on field test data. Nevertheless, the results of the injection test conducted at Site 17 at Indian Head NSF indicate that a significant reduction (64%) in the hydraulic conductivity of the aquifer was achieved at locations where the grout barrier was installed, but did not achieve the 90% reduction performance metric.



Figure 6.4: Well Head Injection Assemblies (Left) and Water Vessels Setup for the Constant-Injection Test

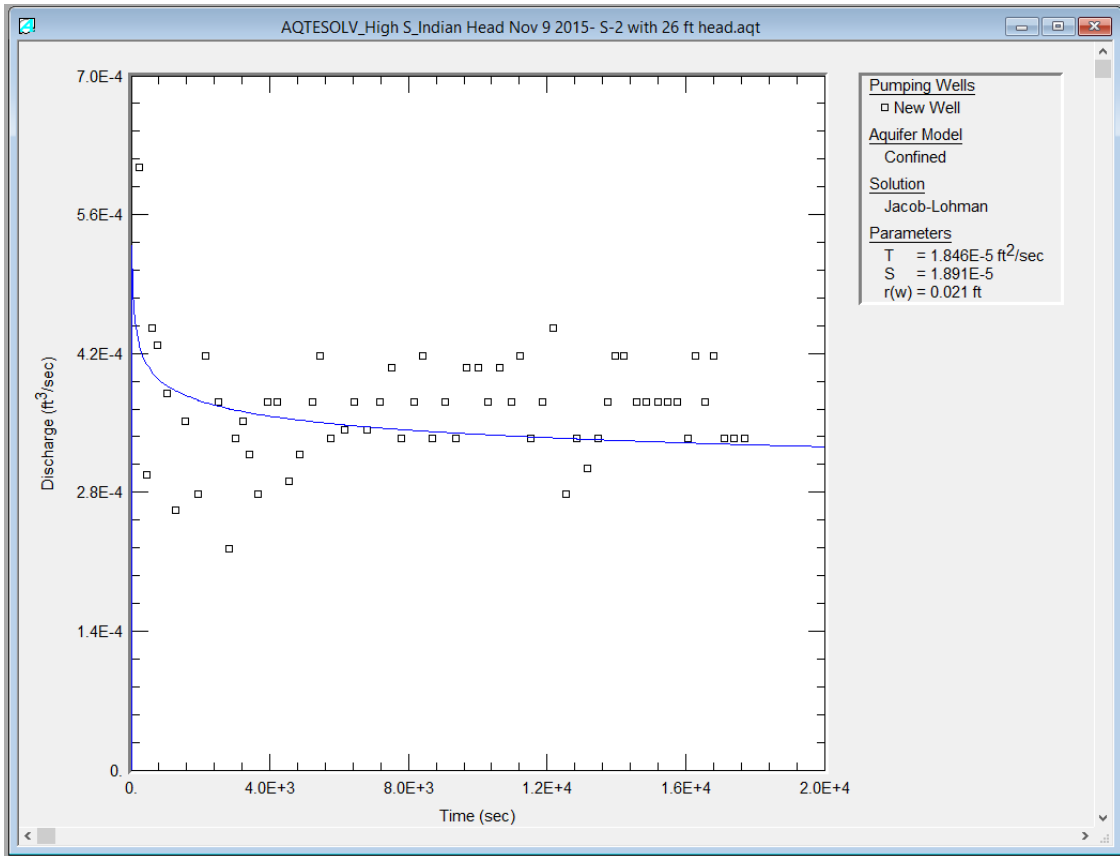

Figure 6.5: Example AQTESOLV Estimation of Aquifer Parameters for the Constant-Head Injection Test Conducted at the Indian Head NSF Site

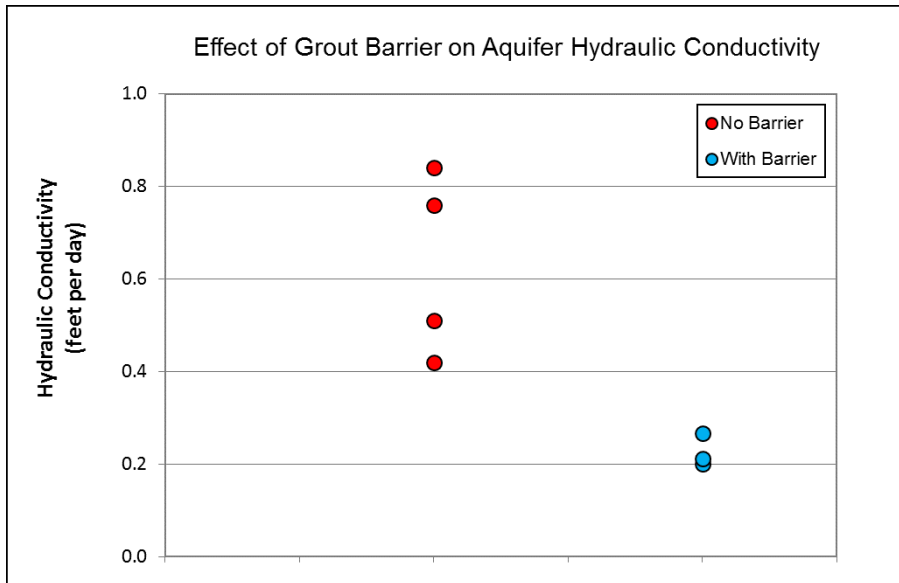

Figure 6.6: Aquifer Hydraulic Conductivities at Site 17 at Indian Head NSF

Page Intentionally Left Blank

7.0 COST ASSESSMENT

The demonstration study included carefully tracking the cost of implementing the field demonstration program. Subsequently, cost data were used to estimate the expected cost of implementing a flux reduction barrier at a hypothetical site. As such, Section 7.1 summarizes the costs tracked associated with the demonstration and presents actual demonstration costs, while Sections 7.2 and 7.3 describe the expected costs for routine application of this technology.

7.1 FIELD DEMONSTRATION COSTS TRACKED

The demonstration study included three key cost elements: i) project planning and preparation, ii) field program implementation, and iii) data evaluation and reporting as outlined below.

7.1.1 Demonstration Study Cost Element: Project Planning and Design

Costs for the project planning and design element of the study involved labor and supplies for the following: i) treatability study for including a novel vegetable oil formulation in the grout (by subcontractor); ii) site selection and coordination with the site Project Manager (PM); iii) engineering design of injection skid; iv) testing and specification of injection grout and formulation and v) detailed design to adapt technology to site-specific needs (partially in parallel to Phase II work). A single test Passive Flux Meter was also deployed to evaluate the suitability of the site for a Phase II application of the technology at the site.

7.1.2 Demonstration Study Cost Element: Field Program and Performance Assessment

Costs for the field program included i) purchase of equipment and supplies to complete the injection; ii) construction, transportation, and start-up support of the injection construction, (by subcontractor); iii) clearing of utilities and installation of injection points (by subcontractors); iv) rental of equipment such as a water tank for potable water, generator, pumps, etc.; and v) associated labor and costs for installation and performance assessments.

7.1.3 Demonstration Study Cost Element: Data Evaluation and Reporting

Data evaluation and reporting include labor time for analyzing Phase 1 results. Detailed costs for each of the cost elements of the demonstration study are provided in Table 7.1 below.

Table 7.1: Summary of Actual Costs for Field Demonstration

Cost Category	Subcategory	Description	Cost	
PROJECT PLANNING AND DESIGN	Treatability Study	Material/Labor (Solutions-IES; Lump Sum)	\$49,900	
	Engineering Design and Site Assessment	Labor	\$55,000	
		Grout mix materials and testing	\$1,550	
		Misc. equipment (Passive Flux Meter and testing beakers, etc.)	\$4,220	
FIELD PROGRAM AND PERFORMANCE ASSESSMENT	Injection Skid and Materials	Injection Skid and Start-Up Support (Subcontractor)	\$50,008	
		Injection Materials and delivery (1 Sodium silicate tote, 1 dibasic ester drum)	\$3,026	
		Injection Materials and delivery (1 vegetable oil drum)	\$1,154	
	Installation and Start-Up	Utility Clearance Subcontractor	\$1,650	
		Drilling Subcontractor - drilling 4 injection points	\$8,730	
		Poly Tank Water Subcontractor - rental of tank and ~3,000 gallons of water delivery	\$2,970	
		Equipment Rental (Generator, forklift)	\$5,506	
		Labor	\$11,500	
		Other Expenses (meals, lodging, travel, consumables)	\$12,110	
		Extraction Tests	Equipment Rental (1 water level meter, 4 pumps)	\$576
	Labor		\$6,900	
	Constant-Head Tests	PolyTank Water Subcontractor - rental of tank and ~1,000 gallons of water delivery	\$1,715	
		Labor	\$6,900	
	Decommissioning	Disposal of Purge Water and remaining materials, including lab analysis for waste characterization	\$3,813	
		Transportation of Skid to Houston	\$4,812	
		Labor	\$700	
	Data evaluation and reporting	Labor	\$5,000	
	Total Costs			\$232,040

7.2 COSTS OF FULL-SCALE INSTALLATION OF FLUX REDUCTION BARRIERS

7.2.1 Estimated Costs at a Hypothetical 1-Acre Site

Applicable costs associated with the field program element of the demonstration study have been employed to develop costs for full-scale implementation of a flux reduction barrier for remediation of affected groundwater. Based on a typical application of the technology at a hypothetical site, full-scale implementation costs have been estimated. Some tasks and associated costs incurred during the field demonstration would not be applicable for a full-scale implementation of the technology; therefore, costs for these items have not been included for the full-scale remediation.

Costs of a full-scale installation of a flux reduction barrier were estimated using the following assumptions regarding the site:

- Treatment Area: A rectangular are with the dimensions of 218 ft by 200 ft, corresponding to an area of 43,600 ft² (i.e., slightly more than one acre) and a total perimeter of length of 836 ft.
- Injection Point Spacing: 4 feet along perimeter
- Depth of Treatment Zone: From 5 ft bgs to 35 ft bgs, corresponding to barrier thickness of 30 ft
- Porosity of Treatment Zone: 30%

Table 7.2 highlights parameters and additional information of assumptions.

Costs were also dependent on the following considerations:

- Grout: Standard sodium silicate solution with dibasic ester hardener having the following composition: 10% sodium silicate, 5% dibasic ester, 85% water (by volume)
- Cost for Grout Components: Cost of sodium silicate, dibasic ester, water and water tank rental projected based on incurred field demonstration costs.
- Time for Implementation: Drilling and injection time estimated based on experience gained during field demonstration.
- Decommissioning: Decommissioning costs estimated to be identical to the incurred field demonstration costs.
- Additional Work: No performance assessment tests to be conducted.

Table 7.3 below summarizes the results of the projected costs at the hypothetical site. As such, for a 1-acre site with a total barrier thickness of 30 ft, the total cost of the technology implementation is approximately \$996K. Subsequently, the cost per cubic yard is \$21/yd³.

Table 7.2: Parameters and Assumptions of Implementation at a Hypothetical Site

<i>Variable</i>	<i>Value</i>	<i>Units</i>	<i>Notes</i>
Injection Grout Materials			
Radius of Influence of Injection Point	2	ft	
Well Spacing	4	ft	Source: Powers, et al., 2007: Construction Dewatering and Groundwater Control: New Methods and Applications, 3d ed.
Perimeter	836	ft	
Number of Injection Points	209		=perimeter/well spacing
Volume of Injection Grout Required per Well	136	ft ³	Includes 20% overpumping
Total Volume of Injection Grout	28,365	ft ³	=number of injection points x volume of injection grout required per well
Total Volume of Injection Grout	212,183	gal	
Cost of Sodium Silicate	\$7.3	\$/gallon	Incurred costs, includes delivery charges
Cost of Dibasic Ester	\$18.4	\$/gallon	Incurred costs, includes delivery charges
Cost of Water and Poly Tank Rental	\$0.4	\$/gallon	Incurred costs, includes delivery charges
Cost of Injection Grout	\$1.99	\$/gallon	*Assume 10% NaSi, 5% DBE, and 85% water
<i>Total Cost of Injection Grout Materials</i>	<i>\$421,915</i>	<i>\$</i>	
Injection Skid			
Capital Cost of Skid + Start-Up Support	\$50,000	\$	Incurred costs, includes delivery charges
<i>Total Cost for Skid and Generator Rental</i>	<i>\$50,000</i>	<i>\$</i>	
Installation and Start-Up			
Drilling Hrs per Injection Point	3		Estimated incurred during field program
Number of Rigs	2		
Total Drilling Time	314	hrs	=number of injection points x Drilling Hrs per injection Point / number of Rigs
Number of work days to complete drilling	40	days	*Assume 9 hrs drilling per day, with 15% safety factor; 5 days per work week
Number of Work Days	40	days	5 days per work week
Total Number of Days	56	days	Includes weekends
Mobilization	\$1,500	\$	Estimated from incurred costs
Add'l costs per Injection Point (permits, completion, etc.)	\$500	\$/injection point	Estimated from incurred costs
Add'l costs for Injection Points	\$104,500	\$	= Add'l costs per Injection Point x Number of Injection Points
Cost per day	\$2,000	\$/day/truck	Incurred costs
Utility Clearance	\$5,000	\$	Estimated from incurred costs
<i>Total Drilling Subcontractors</i>	<i>\$336,733</i>	<i>\$</i>	
Injection Time			
Hours per Injection Point (4 depths)	4	hrs/point	Estimated incurred during field program
Simultaneous Injections	3	points/ time	Per skid design
Total Injection Time	35	days	*Concurrent injection with drilling, requiring no additional time on site
Other Equipment Rental			
Generator Rental	\$1,300	\$/month	Incurred costs, includes delivery charges
Generator Total	\$2,429	\$	=Generator Rental per month x Total number of Days/30
Forklift Rental	\$1,050	\$/week	Incurred costs, includes delivery charges
Forklift Total	\$1,050	\$	= Forklift Rental per Week x Number of Weeks. Assume 1 week for install and decommissioning
Car Rentals, Consumables	\$100	\$/day	Incurred costs
Car Rentals, Consumables Total	\$5,606	\$	= Car Rentals, Consumables x Total number of Days
<i>Rentals Total</i>	<i>\$9,685</i>	<i>\$</i>	
Labor and Other Expenses			
Assume 2 field personnel onsite	\$2,300	\$/day	=Typical labor costs/hr x 10 hrs per day
Other expenses (meals/lodging)	\$170	\$/day	Typical meals/lodging per day
<i>Total Labor and Other Expenses</i>	<i>\$101,664</i>	<i>\$</i>	=Total daily costs x Total number of Days
Decommissioning			
Waste Disposal of remaining materials, including lab analysis for waste characterization	\$3,800	\$	Incurred costs, includes delivery charges
Transportation of Skid	\$4,800	\$	Incurred costs
<i>Decommissioning Total</i>	<i>\$8,600</i>	<i>\$</i>	

Table 7.3: Estimated Costs of Implementation at a Hypothetical 1-Acre Site

Cost Category	Subcategory	Description	Estimated Cost	Notes
PROJECT PLANNING AND DESIGN	Treatability Study	n/a	--	Not applicable
	Engineering Design and Site Assessment	Labor	\$65,000	Estimated
		Grout mix materials and testing	\$1,550	Estimated
		Misc. equipment (testing beakers, etc.)	\$500	Estimated
FIELD PROGRAM	Injection Skid and Materials	Injection Skid + Start-Up Support (Subcontractor)	\$50,000	See Table 7.3 for parameters and assumptions
		Injection Grout Materials, transportation, and Water + Tank Rental (Sodium silicate tote, dibasic ester drum)	\$421,900	See Table 7.3 for parameters and assumptions
	Installation and Strat-Up	Drilling Subcontractors (including utility clearance)	\$337,000	See Table 7.3 for parameters and assumptions
		Other Equipment Rental (Generator, forklift, car rental)	\$9,700	See Table 7.3 for parameters and assumptions
		Labor + Other Expenses (meals, lodging, travel)	\$102,000	See Table 7.3 for parameters and assumptions
	Performance Assessment	N/A	--	
DECOMMISSIONING	Decommissioning	Waste Disposal of remaining materials, including lab analysis; labor; transportation of skid.	\$8,600	See Table 7.3 for parameters and assumptions
Total for 1 Acre Site (\$)			\$996,250	
Treatment Volume (yd³)			48,444	
Cost per Cubic Yard (\$/yd³)			\$20.6	

7.2.2 Comparison of Flux Reduction Barriers with Other Technologies

The typical cost of installing a flux reduction barrier for remediation of groundwater affected with chlorinated organics has been compared to the typical cost of implementing an Enhanced In Situ Bioremediation (EISB) project at a Case 1 Study Site (Table 7.4), as described in Harkness and Konzuk’s Chapter 16 in Kueper et al. (2014).

Table 7.4: Description of Case Study Site

Parameter	Case Study Site
Area	1,500 m ² (16,145 ft ² ; 0.11 acre)
Depth to Groundwater	1.5 m (4.9 ft)
Depth to Aquitard	4.5 m (14.8 ft)
Saturated Thickness	3.0 m (9.8 ft)
Porosity	0.3
Groundwater velocity	32 m/yr (105 ft/yr)
Barrier Thickness	3 m (9.8 ft)

Here, the EISB project consists of the following key assumptions (Kueper, et al., 2014):

- Injection of emulsified vegetable oil (EVO)
- EVO applied through a series of 50 injection wells spaced on 5.4 m (17.7 ft) centers distributed across source area
- 2-inch diameter injection wells screened across the saturated zone

- Addition of 349 kg (768 lbs) of commercial EVO solution to each injection point, along with 25,090 L (6,630 gallons) of groundwater to ensure complete distribution. Two injections assumed.
- Injections will be performed by a two-person crew requiring 26 days of labor including mobilization, setup and breakdown.

Additionally, in order to provide an equal comparison, costs for a Flux Reduction Barrier was estimated for the parameters outlined in the Case Study Site (Table 7.5). Also, a total monitoring time period of source area monitoring wells for 10 years is assumed for both technologies. For Flux Reduction Barriers, assessment of mass flux using Passive Flux Meters is included in monitoring, in addition to groundwater analyses.

As seen in Table 7.5 below, the total 10-year project cost for EISB is \$1,200K and that of a Flux Reduction Barrier is \$640K. The cost per volume of both remedies is \$663/yd³ and \$355/yd³, respectively. Note that these costs per unit volume are much greater than those typically observed at chlorinated solvent sites (McGuire et al., 2016), because i) the Case Study site is small (0.1 acre and 10 ft of treatment zone thickness); and ii) total monitoring costs for 10 years after remediation are incorporated.

Table 7.5: Detailed Cost Analysis Comparison between EISB and Flux Reduction Barriers

Cost Element	EISB ¹	Flux Reduction Barriers	Notes
Design			
Laboratory Studies	\$25,000	\$2,050	
In-field hydraulic and injection testing	\$19,000	--	
Detailed design, permitting, and report	\$88,000	\$65,000	
Procurement	\$12,000	--	Included in "Detailed design"
Total Design	\$144,000	\$67,050	
Capital			
Mobilization/demobilization	\$4,000	--	Included in "Implementation labor"
Injection Skid	--	\$50,000	
Well surveying	\$4,000	\$5,000	
Drilling and well installation	\$106,000	\$108,623	
Flow control equipment, instrumentation, controls	\$114,000	--	
Start-up costs	\$7,000	--	
Materials (including amendments, shipping, utilities)	\$61,000	\$48,633	
Implementation labor, travel, per diem	\$65,000	\$34,177	
Bioaugmentation	\$57,000	--	
Waste management and disposal	\$24,000	\$8,600	
Field and home office support	\$56,000	--	
Contractor oversight	\$67,000	--	Included in Drilling and well installation
Reports	\$27,000	\$27,000	
Total Capital	\$592,000	\$282,033	

Notes: 1) Source: Kueper et al., 2014, Table 16.5. Note that monitoring was estimated to be for 10 years for both technologies.

Table 7.5. Detailed Cost Analysis Comparison between EISB and Flux Reduction Barriers (cont'd)

Cost Element	EISB ¹	Flux Reduction Barriers	Notes
O&M (per event/yr)			
Equipment rental	\$9,000	--	
Operation – materials (including shipping and electrical)	\$61,000	--	
Operation – labor, travel, per diem	\$65,000	--	
Operation – oversight	\$13,000	--	
Replacement parts and materials, well rehab	\$3,000	--	
Field and home office support	\$15,000	--	
Reports	\$18,000	--	
Total O&M (per injection/yr operations)	\$184,000	\$0	No O&M required for barriers
Monitoring Costs (during/post-treatment)			
Monitoring well installation (first year only)	\$10,600	\$10,600	
Labor (quarterly monitoring)	\$7,200	\$7,200	
Analytical, groundwater (quarterly monitoring)	\$8,000	\$8,000	
Waste management and disposal	\$1,400	\$1,400	
Reports (annual)	\$10,000	\$10,000	
Mass flux measurements (year 1)	--	\$7,440	Assume 2 locations sampled once in year 1
Mass flux measurements (recurring after year 1)	--	\$827	Assume 2 locations sampled every 5 years
Total monitoring (year 1)	\$37,200	\$44,640	Assume quarterly monitoring
Total monitoring (recurring after year 1)	\$26,600	\$27,427	
Total Monitoring Costs for 10 Years	\$276,600	\$291,480	
TOTAL PROJECT COST (\$)	\$1,196,600	\$640,563	
Treatment Volume (yd³)	1,804	1,804	
TOTAL PROJECT COST (\$/yd³)	\$663	\$355	

Notes: 1) Source: Kueper et al., 2014, Table 16.5. Note that monitoring was estimated to be for 10 years for both technologies.

Additionally, Kueper et al., 2014 presented implementation costs using In Situ Chemical Oxidation (ISCO), Thermal Treatment, and Pump and Treat at this Case Study Site. Total monitoring costs for these technologies is assumed to be the same as that of EISB, described above for a 10-year project life. As seen in Table 7.6, the total project cost for these technologies ranges from \$1,200K to \$3,960K, as compared to that of \$640K for Flux Reduction Barriers. As such, Flux Reduction Barriers are the more cost-effective technology alternative.

Table 7.6: Cost Comparison of Flux Reduction Barriers with Other Remedial Options

Cost Component	EISB	ISCO	Thermal	Pump and Treat	Flux Reduction Barriers
Design	144	134	248	254	67
Capital	592	705	2080	465	282
O&M	184	990	0	2967	0
Monitoring	277	277	277	277	291
Total (\$K)	1,200	2,100	2,600	3,960	640
Total (\$/yd3)	663	1,170	1,440	2,200	355

*Note: monitoring costs for EISB, ISCO, Thermal, and Pump and Treat assumed to be all for 10 years for comparison purposes. Keuper et al., 2014 listed varying monitoring time periods for these technologies.

7.3 COST DRIVERS

The cost of implementing flux reduction barriers is driven by the following factors: i) treatment depth, ii) site geology and injection point spacing. These factors influence the total volume of injection material required, as well as the drilling time for injection point installation.

8.0 IMPLEMENTATION ISSUES

How to Build Source Zone Barriers

- The technical literature is very helpful to understand how to design and build permeation grouting barriers. Two key references are Powers et al. (2007) and Karol et al. (2003) (Section 5.1.1)
- Different grouts can be applied for different conditions, with acrylamides being useful for very low permeability formations and cements for high permeability ones. The minimum range for application of silica gel grouts was reported to 1×10^{-6} to 1×10^{-5} cm/sec by one reference, while a second reference suggested a minimum hydraulic conductivity of 1×10^{-4} cm/sec. Note that silica gel is much cheaper and easier to use than acrylamide grouts and concrete grouts are more commonly used for coarse alluvial material.
- Groups interested in implementing the barrier technology have two broad options: 1) Hire a geotechnical contractor and use permeation grouting equipment (such as tube-a-manchette) or other barrier technologies (e.g., slurry wall or sheet piles); 2) or use commonly used remediation equipment such as direct push rigs with modified injection equipment to mix silica gel, hardener, and water (see Section 5.4 and Appendix E for information about the mixing skid used for this project).

Benefits of Barriers

- One of the benefits of the barrier technology is the potential for enhancing NSZD by establishing an enhanced reductive dechlorination zone when the competing electron acceptors are diverted. One research paper (Newell and Aziz, 2004) estimate a potential increase in NSZD rates of 226 kg/year (500 lbs/yr) at a typical chlorinated solvent site with electron acceptor diversion and 100% efficiency; see Appendix A for an example calculation at a hypothetical site and the BIOBALANCE tool (Kamath et al, 2008) for more information. A key requirement is that the site contains electron donor in the source zone, either that is from naturally occurring organic material in the source zone; fermentable oils or other electron donors that were released along with the chlorinated solvents (a fairly common occurrence at DoD sites); or there has been an electron donor addition project to accompany the construction of the barrier.

What Type of Site Conditions Are Needed

- For high efficiency barriers with significant flow reduction, the site must have a lower low permeability unit such as a clay to prevent up flow; and a four sided barrier is recommended (three sided barriers are likely to have lower performance (Section 5.1.3).
- For accessing the lower cost silica gel grouting technology, the hydraulic conductivity of the transmissive unit should be in the range of 5×10^{-4} to 10^{-2} cm/sec.

- The source zone should contain electron donor to realize the benefit of electron acceptor diversion that a barrier provides. Sites with faster groundwater will have more benefit than sites with slow groundwater.

Using Existing Remediation Technology for Barriers

- This ESTCP demonstration was able to use existing remediation technology (direct push rigs and injection skids) to build four small barriers for the Small-Scale Demonstration.
- The mixing process is generally more complex than standard injection-based remediation projects because the injection skid needs to mix three fluids, delivery multiple locations simultaneously, let operators see pressure, flowrate, and have contingency for grout set-up in the injection manifolds. The design described in Section 5.4 and Appendix E worked well.

Designing Permeation Grout Barriers

- Permeation grouting requires filling all the porosity, not just the mobile porosity. This increases the amount of grout required for the barrier as total porosity in the 24% to 44% range are typically used for the volume of grout needed calculation compared to 2% to 10% for the mobile porosity. Note the Small Scale Demonstration and the calculations in Section 6 assumed 30% porosity for the fine sand present in the test area.
- Munitions can complicate installation, but same holds for any injection based technology.
- The silica gel grout was much more reliable in terms of grouting times when the inorganic hardener (dibasic ester (DBE)) was used (Section 5.3). On-site gel tests are important to confirm that the groundwater chemistry will work with the design mix of gel and hardener (Section 6.1.2). This is particularly true at sites with saline groundwater.
- If a direct push rig is used for injection and the injection zone is more than a few feet thick, multi-level injection wells (Section 5.4.2) are important to ensure even vertical distribution of the grout. If a permeation grouting contractor is used, a tube-a-manchette rig will provide good vertical distribution of grout in the barrier.

Design and Performance of Small Scale Demonstration

- It was difficult to assess performance of the barrier for the Small-Scale Demonstration at the chosen location. Contributing factors include:
 - The hydraulic conductivities were relatively low (0.63 feet per day (2×10^{-4} cm/sec) (Section 6.3.2) resulting in low pumping rates (< 0.1 gpm) and low volumes of extracted groundwater during the before- and after-tests (< 20 gallons);
 - Potential construction problems associated with the multi-level injection wells in a very fine-grained heterogeneous unit (Section 5.4.2) as one injection well had to be abandoned (Section 6.2).

- The “donut” configuration (Section 5.1.2) may have not been efficient at testing the permeation grouting process; a larger demonstration area may have resulted to better test data. However using constant head injection tests, **an average of 64% reduction in flow resulted**, which is significant but below the 90% reduction performance goal. This result, and relatively low hydraulic conductivities in the planned Northern Plume test area, led to the decision not to perform the Large-Scale Demonstration.
- Applications for the flux reduction technology are likely to have better performance at sites with higher permeability and higher groundwater velocity than at the site used for the demonstration, both for demonstrating the hydraulic effect of the barrier and the benefits from electron acceptor diversion.

Novel Grouting Material

- The Solutions-IES grout material consisting of a silica gel/veg oil mix appeared to work as well as conventional silica gel for reducing flow (Table 6.4), but since the Small-Scale Demonstration was performed in a relatively unimpacted zone, the project was unable to test its dechlorination capabilities in the field. The theory behind the gel/oil material is sound as permeation grouting barriers are designed to reduce but not eliminate groundwater flow through them, therefore providing a mechanism for increased treatment with the oil.

Page Intentionally Left Blank

9.0 REFERENCES

- Adamson, D., McGuire, T., Newell, C., Stroo, H., 2011. Sustained Treatment: Implications for Treatment Timescales Associated With Source-Depletion Technologies. Remediation, Spring 2011.
- Annable, M., Hatfield, K., Cho J., Klammer, H., Parker, B., Rao, P., 2005. Environmental Science and Technology.
- Berry, R.M. 2000. When Grouting Don't Forget the Soil. Avanti, <http://www.avantigrout.com/component/zoo/item/when-grouting-don-t-forget-the-soil>
- Borden, R.C., Yuncu, B., Shrestha, S.R., Kulkarni, P.R., Newell, C.J., 2014. Draft Treatability Report: Formulation of a Vegetable Oil-Based Material for Contaminant Flux Reduction Barriers. Prepared for ESTCP. August 2014. CH2MHill, 2004. Site-Specific Remedial Investigation Report Sites 11, 13, 17, 21, and 25. April 2004
- CH2MHill, 2008. Site 17 Groundwater Feasibility Study, October 2008
- CH2MHill, 2012. Site 17 Remedial Action Work Plan, August 2012
- CH2MHill, 2014a. Site 17 Investigation after Short-Term Performance Monitoring of the Remedial Action Uniform Federal Policy-Sampling and Analysis Plan, January 2014
- CH2MHill, 2014b. Site 17 Annual Report, March 2014
- Hatfield, K., Annabe, M., Cho, J., Rao, P.S.C., Klammler, H., 2004. A Direct Passive Method for Measuring Water and Contaminant Fluxes in Porous Media. Journal of Contaminant Hydrology 75, 155-181.
- Kamath, R., Newell C., 2008. BIOBALANCE: A Mass Balance Toolkit. Savannah River National Laboratory and U.S. Department of Energy. <http://www.gsi-net.com/en/software/free-software/biobalance-toolkit.html>
- Karol, Reuben H., 2003. *Chemical Grouting and Soil Stabilization*, 3d ed., Marcel Dekker, Inc., New York, New York.
- Kim, M., Corapcioglu, M.Y., 2002. Gel barrier formation in unsaturated porous media. Journal of Contaminant Hydrology. 26.
- Krembs, F., Siegrist, R., Crimi, M., Furrer, R., Petri, B., 2010. ISCO for Groundwater Remediation: Analysis of Field Applications and Performance. Groundwater Monitoring & Remediation.
- Leeson, A, and H. Stroo, 2011. Workshop Report: SERDP and ESTCP Workshop on Investment Strategies to Optimize Research and Demonstration Impacts in Support of DoD Restoration Goals. SERDP/ESTCP, Oct. 2011.

- Looney, 2011 . Personal communication based on Department of Energy (DOE) experience at several sites.
- Kueper, B.H., Stroo, H.F., Vogel, C.M., Ward, C.H., 2014. Chlorinated Solvent Source Zone Remediation. New York.
- McDade, J.M., T.M. McGuire, and C.J. Newell. 2005. Analysis of DNAPL Source Depletion Costs at 36 Field Sites, *Remediation*, 2005, 15(2).
- McGuire, T.M., McDade, J.M., Newell, C.J., 2006. Performance of DNAPL Source Depletion Technologies at 59 Chlorinated Solvent-Impacted Sites. *Groundwater Monitoring & Remediation*. Volume 26, Issue 1, pages 73-84, February 2006.
- McGuire, T.M., Adamson, D.T., Newell, C.J., Kulkarni, P.R., 2016. Final Report: Development of an Expanded, High-Reliability Cost and Performance Database for In-Situ Remediation Technologies. ESTCP Project ER-201120. March 2016.
- McHugh, T.E., J.A. Connor, F. Ahmad, and C. J. Newell, 2003. A Groundwater Mass Flux Model For Groundwater-To-Indoor-Air Vapor Intrusion. in: V.S. Magar and M.E. Kelley (Eds.),
- Moridis, G.J., Finsterle, S., 1999. Evaluation of alternative designs for an injectable subsurface barrier at the Brookhaven National Laboratory site, Long Island, New York. *Water Resources Research*, Vol. 35, No. 10, Pg. 2937-2953.
- Moridis, G.J., James, A., Oldenburg, C., 1997. Development of a Design Package for a Viscous Barrier at the Savannah River Site. *Land Contamination & Remediation*, 5 (3).
- Newell, C. J., L. P. Hopkins, and P. B. Bedient, 1990. "A Hydrogeologic Database for Groundwater Modeling", *Ground Water*, Vol. 28, No. 5.
- Newell, C., and C. Aziz, 2004. Long-term sustainability of reductive dechlorination reactions at chlorinated solvent sites. *Biodegradation*, 387-394.
- Newell, C., C. Aziz, C., and G. Cox, 2003. *Enhanced Anaerobic Treatment Zones in Groundwater*, U.S. Patent No. US 6,562,235 B1. United States.
- Newell, C., Farhat, S.K., Adamson, D.T., Looney B.B. Contaminant Plume Classification System Based on Mass Discharge, 2011. *Ground Water*, 49(6). Nov-Dec 2011.
- Newell, C.J., Kueper, B.H., Wilson, J.T., Johnson, P.C., 2014. Natural Attenuation Of Chlorinated Solvent Source Zones. In: Kueper, B.H., Stroo, H.F., Vogel, C.M., Ward, C.H. (Eds.), *Chlorinated Solvent Source Zone Remediation*. Springer New York, New York, NY, pp. 459-508. SERDP/ESTP Monograph.
- Payne, F. C., J. A. Quinnan, and S. T. Potter, 2008. *Remediation Hydraulics*, CRC Press.

- Powers, J., Corwin, A., Schmall, P., Kaeck, W., 2007. *Grouting Methods in Construction Dewatering and Groundwater Control: New Methods and Applications*, Third Edition, John Wiley & Sons, In., Hoboken, NJ, USA.
- Powers, J. Patrick, Arthur B. Corwin, Paul C. Schmall, and Walter E. Keck, 2007. *Construction Dewatering and Groundwater Control: New Methods and Applications*, 3d ed., John Wiley & Sons, Inc., Hoboken, New Jersey.
- RRC, 2014. "Technical Review, Summary of Standards and Procedures, Injection/Disposal Well Permitting, Testing, and Monitoring Manual," Railroad Commission of Texas, Internet, accessed 16 October 2014, available at <http://www.rrc.state.tx.us/oil-gas/publications-and-notices/manuals/injectiondisposal-well-manual/summary-of-standards-and-procedures/technical-review/>.
- Sale, T., C. Newell, H. Stroo, R. Hinchee, and P. Johnson, 2008. *Frequently Asked Questions Regarding Management of Chlorinated Solvents in Soils and Groundwater*, ESTCP Project ER-0530.
- Truex, M., Pierce, EM., Nimmons, MJ., Mattigod, SV, 2011. *Evaluation of In Situ Grouting as a Potential Remediation Method for the Hanford Central Plateau Deep Vadose Zone*. Prepared for the U.S. Department of Energy. Prepared by: Pacific Northwest National Laboratory.
- Weaver, J. W., and F. D. Tillman, 2005 *Uncertainty and the Johnson-Ettinger Model for Vapor Intrusion Calculation*, USEPA Document EPA/600/R-05/110, Sept. 2005.
- Wiedemeier, T.H., Rifai, H.S., Newell, C.J., and Wilson, J.W., 1999. Natural Attenuation of Fuels and Chlorinated Solvents, John Wiley & Sons, New York. (equation 2.12)

**APPENDIX A ENHANCED REDUCTIVE DECHLORINATION ZONE
(ERDZ) CALCULATION**

APPENDIX A
TCE MASS REMOVED BY ELECTRON ACCEPTOR DIVERSION
 ESTCP Barriers Project

User Input
Calculated
Literat. Value

CALCULATE REDUCTION IN FLOW AT HYPOTHETICAL SITE

b = saturated aquifer thickness	6.1	m
i = regional hydraulic gradient	1.0E-02	m/m
K = hydraulic conductivity	0.0200	cm/sec
Width of barrier / treatment zone perpend. to flow	137	m
Groundwater Darcy Velocity (K*i)	6.3	m/yr
Volumetric Groundwater Flowrate	5,246,525	Liters/year
% Reduction in Flowrate After Barrier Construction	90%	%
Volume Groundwater Diverted	4,721,872	Liters/year

Notes

- Thickness of transmissive zone; from boring logs
- From potentiometric surface maps
- From slug test, pump test, estimates based on material
- From plume/source zone maps
- Calculated; can overwrite if desired. Do not use seepage velocity.
- Calculated; can overwrite formula if desired
- Performance of barrier; 90% is typical for pemeation grouting
- Calculated; can overwrite formula if desired

Plan View of Barrier

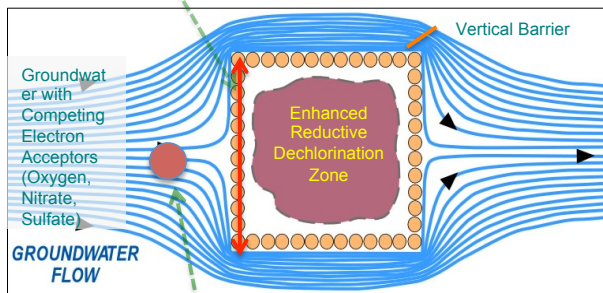

Get these data from background monitoring well(s) upgradient of the source

CALCULATE INCREASE IN BIODEGRADATION DUE TO ELECTRON ACCEPTOR DIVERSION

lbs TCE degraded to ethene per lb of H ₂ :	22
Assumed Efficiency (% of hydrogen going to dechlorination)**:	50%

Competing Electron Acceptors in Upgradient Groundwater	Concentration in Groundwater Entering Source Zone (mg/L)	Difference in Electron Acceptor Mass Discharge (kg/year)	H ₂ Equiv. Per kg Analyte*** (kg/yr)	H ₂ Equivalents (kg/yr)	Assimilated Capacity for TCE (kg/yr)
DO	8	38	8.0	4.7	52
Nitrate	6	28	12	2.3	25
Sulfate	50	236	12	20	216

Total

Total: 293 kilograms/year

* Newell and Aziz (2004) (Median from Table 1)

** Newell and Aziz (2004) assumed 100% efficiency to demonstrate potential of diversion. This parameter is difficult to estimate, but After a few years, the hydrogen will go to either methanogenesis or dechlorination. 50% is a good planning level value.

*** BIOBALANCE Tool

This is the amount of extra CVOC biodegradation that could occur if a barrier is installed and competing electron acceptors are diverted away from the source zone.

Add this value to reduction in CVOC mass discharge due to the barrier to get the total benefit from a barrier project.

APPENDIX B SITE GEOLOGY

APPENDICES

Appendix B: Site Geology

Contents:

- Appendix B.1 Geology and Extent of Contamination of Small-Scale Demonstration Area
- Appendix B.2 Geology and Extent of Contamination of Large-Scale Demonstration Area

APPENDICES

Appendix B.1: Geology and Extent of Contamination of Small-Scale Demonstration Area

APPENDIX B.1 Soil Boring Log for IS17MW03



PROJECT NUMBER 156175	BORING NUMBER IS17MW03
<small>SHEET 1 OF 1</small>	
SOIL BORING LOG	

PROJECT : NDWIH LOCATION : Site 17
 ELEVATION : See survey report DRILLING CONTRACTOR : Parratt-Wolff Inc.
 DRILLING METHOD AND EQUIPMENT USED : ATV Rotary Drill Rig, CME 850, 8" hollow stem augers, 2' split spoon sampling
 WATER LEVELS : First encountered at 11 ft bgs START : 8/11/00 END : 8/11/00 LOGGER : Fred Calef

DEPTH BELOW SURFACE (FT)	INTERVAL (FT)			STANDARD PENETRATION TEST RESULTS	CORE DESCRIPTION	COMMENTS
	RECOVERY (FT)	#/TYPE		6"-8"-6"-8" (N)	SOIL NAME, USCS GROUP SYMBOL, COLOR, MOISTURE CONTENT, RELATIVE DENSITY, OR CONSISTENCY, SOIL STRUCTURE, MINERALOGY.	DEPTH OF CASING, DRILLING RATE, DRILLING FLUID LOSS, TESTS, AND INSTRUMENTATION.
		RECOVERY (FT)	#			
0 - 2	1.3	1	1S	3-3-4-5 (7)	Clay. Med-stiff. Dry to moist. Orange.	Breathing zone PID = 0
2 - 4	1.5	2	2S	5-7-5-9 (12)	Clay. Med-stiff. Dry to moist. Orange to gray with orange "streaks." Slightly wetter than previous spoon.	Breathing zone PID = 0
4 - 6	0.25	3	3S	wH-wH-wH-4 (wH)	greenish gray clay with some silt. Wet. Some organics	Breathing zone PID = 0
6 - 8	2	4	4S	6-9-9-9 (18)	Clay. Med-stiff. Dry to moist. Light gray with orange "streaks."	Breathing zone PID = 0
8 - 10	2	5	5S	3-2-2-2 (4)	Clay. Med-stiff. Dry to moist. More moist than previous spoon. Reddish-gray. Some orange "streaks."	Breathing zone PID = 0
10 - 12	2	6	6S	6-7-7-8 (14)	0-18" clay. Med-soft. Moist. Reddish gray. 18-24" fine-med sand. Orange. Wet. Well sorted.	Breathing zone PID = 0
12 - 14	2	7	7S	8-9-9-6 (18)	0-12" fine-med sand. Orange. Saturated. Well sorted. 12-24" Fine sand. Wet to saturated. Med-soft. Well sorted. Orange.	Breathing zone PID = 0
14 - 16	2	8	8S	5-7-6-3 (13)	Fine sand with clay. Saturated to wet. Well sorted. Orange.	Breathing zone PID = 0
					Setting well at 16 feet bgs	

(CH2MHill, 2008)

APPENDIX B.1 Geologic Cross-Section

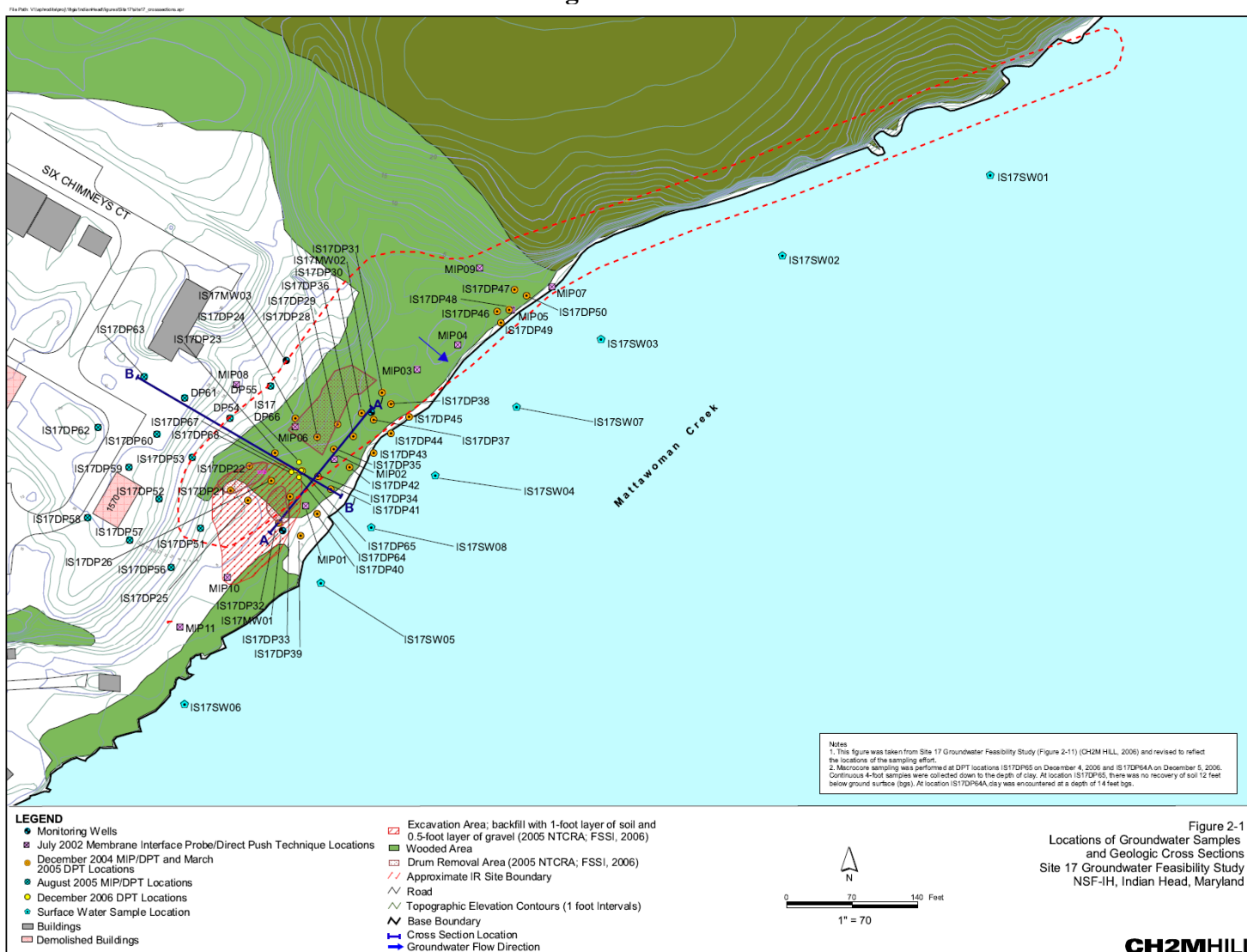

(CH2MHill, 2008)

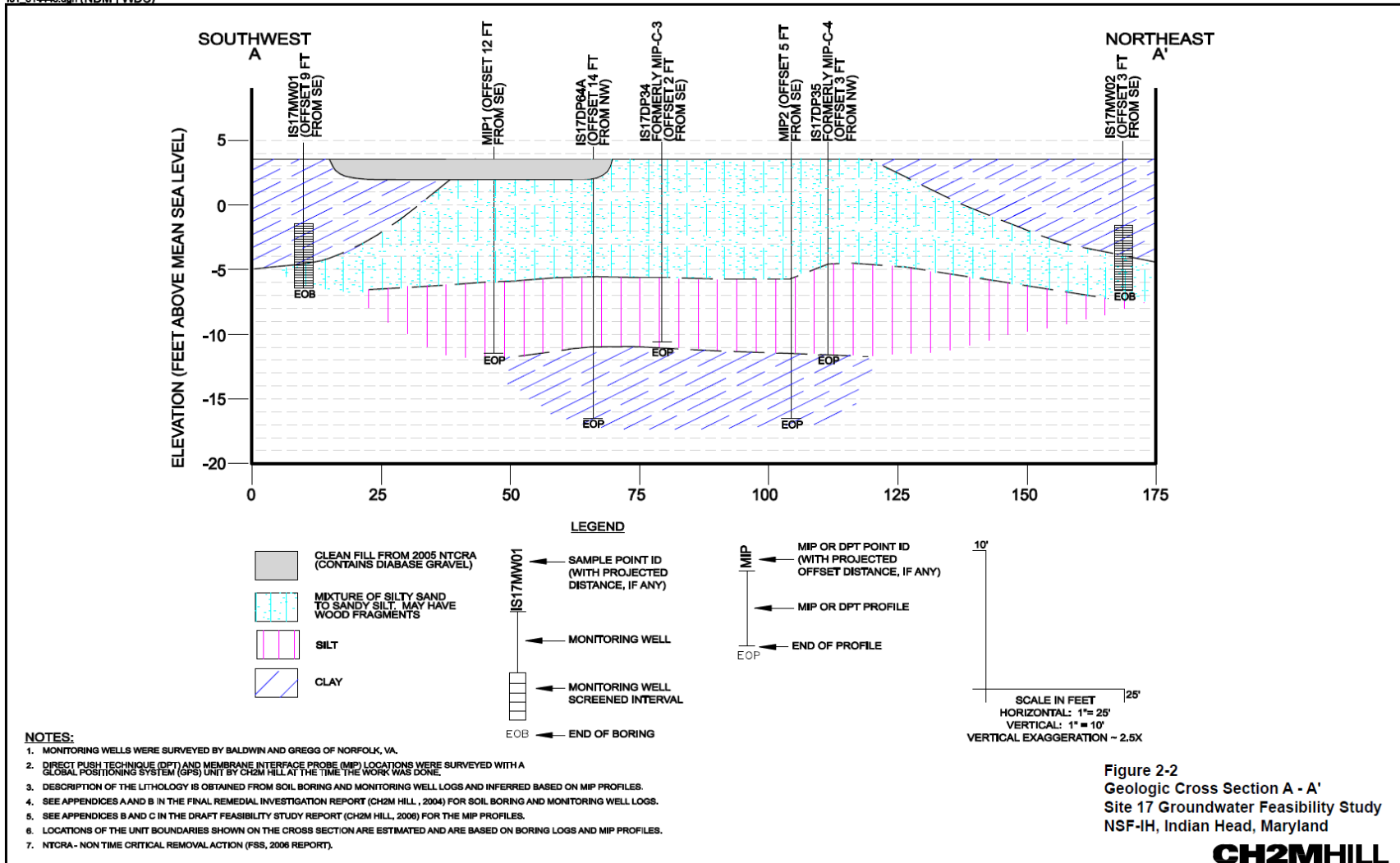
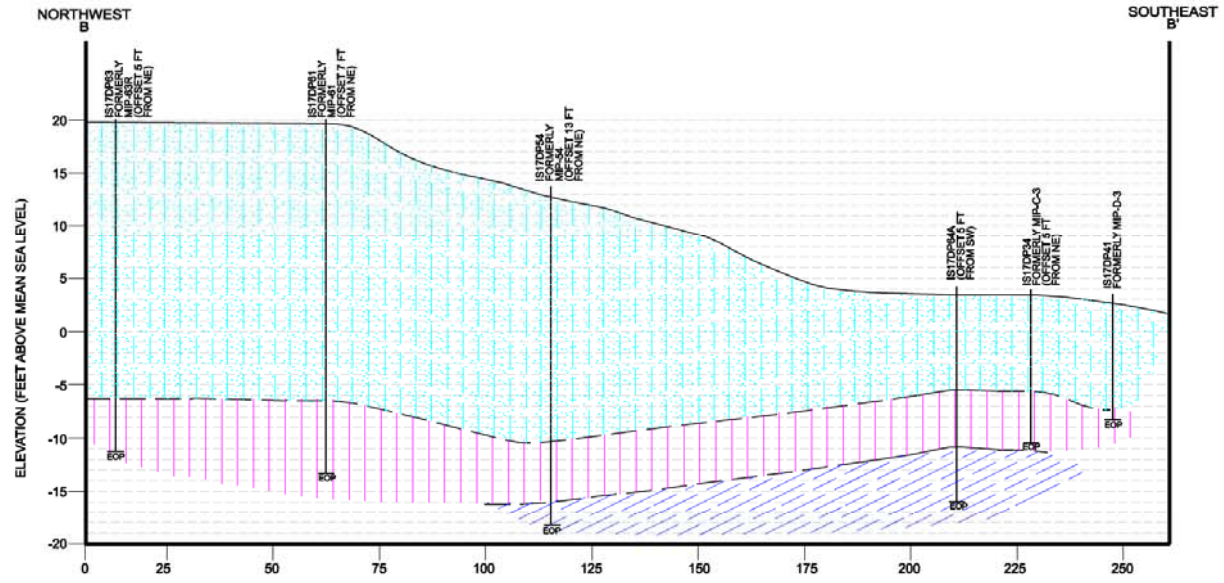

Figure 2-2
 Geologic Cross Section A - A'
 Site 17 Groundwater Feasibility Study
 NSF-IH, Indian Head, Maryland

CH2MHILL

(CH2MHill, 2008)



LEGEND

- MIXTURE OF SILTY SAND TO SANDY SILT, MAY HAVE WOOD FRAGMENTS
- SILT
- CLAY

- MIP OR DPT POINT ID (WITH PROJECTED OFFSET DISTANCE, IF ANY)
- MIP OR DPT PROFILE
- END OF PROFILE

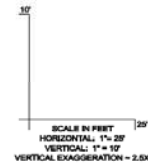

NOTES:

1. MONITORING WELLS WERE SURVEYED BY BALDWIN AND GREGG OF NORFOLK, VA.
2. DIRECT PUSH TECHNIQUE (DPT) AND MEMBRANE INTERFACE PROFILE (MIP) LOCATIONS WERE SURVEYED WITH A GLOBAL POSITIONING SYSTEM (GPS) UNIT BY CH2M HILL AT THE TIME THE WORK WAS DONE.
3. DESCRIPTION OF THE LITHOLOGY IS OBTAINED FROM SOIL BORING AND MONITORING WELL LOGS AND INFERRED BASED ON MIP PROFILES.
4. SEE APPENDICES B AND C IN THE FINAL REMEDIAL INVESTIGATION REPORT (CH2M HILL, 2004) FOR SOIL BORING AND MONITORING WELL LOGS.
5. SEE APPENDICES B AND C IN THE DRAFT FEASIBILITY STUDY REPORT (CH2M HILL, 2006) FOR THE MIP PROFILES.
6. LOCATIONS OF THE UNIT BOUNDARIES SHOWN ON THE CROSS SECTION ARE ESTIMATED AND ARE BASED ON BORING LOGS AND MIP PROFILES.

Figure 2-3
Geologic Cross Section B - B'
Site 17 Groundwater Feasibility Study
NSF-IH, Indian Head, Maryland

CH2MHILL

(CH2MHill, 2008)

APPENDIX B.1
Groundwater Sampling Results at IS17MW03

Station ID	IS17MW03
Sample ID	IS17GW031213
Sample Date	12/05/13
Chemical Name	
Volatile Organic Compounds (UG/L)	
cis-1,2-Dichloroethene	0.5 U
Trichloroethene	0.81 B
Vinyl chloride	0.5 U
Wet Chemistry (MG/L)	
Ethane	0.0013 U
Ethene	0.0016 U
Methane	0.019
Nitrate	0.042 U
Sulfate	33
Dechlorinating Bacteria (CELLS/ML)	
Dehalococcoides	0.5 U

Notes:

Bold indicates detections

B - Analyte not detected above the level reported in blanks

U - The material was analyzed for, but not detected

ug/L = micrograms per liter

mg/L = milligrams per liter

Cells/mL = Cells per milliliter

The Sample ID is read as follows: I is for Indian Head; S is for site; 17 is the site number; MW03 is groundwater sample from station 3; and 1213 is the month (December) and year of collection (2013)

(CH2MHill, 2014)

APPENDICES

Appendix B.2: Geology and Extent of Contamination of Large-Scale Demonstration Area



PROJECT NUMBER: 387444	BORING NUMBER: IS17DP70D	SHEET 1 OF 1
SOIL BORING LOG		

PROJECT : NSF Indian Head, Site 17 LOCATION : Indian Head, Maryland
 ELEVATION : DRILLING CONTRACTOR : Parratt - Wolff
 DRILLING METHOD AND EQUIPMENT : Geoprobe, DPT

DEPTH BELOW EXISTING GRADE (ft)			SOIL DESCRIPTION	SYMBOLIC LOG	Water level	PID (ppm)	WELL DIAGRAM
INTERVAL (ft)	RECOVERY (ft)	SAMPLE ID (TIME)	SOIL NAME, USCS GROUP SYMBOL, COLOR, MOISTURE CONTENT, RELATIVE DENSITY OR CONSISTENCY, SOIL STRUCTURE, MINERALOGY				
0.0			Sandy Silt (ML) 0.0 - 1.0' - yellow red (5 YR 5/6), moist, firm, little fine to medium sand			0-2': 0.0 ppm 2-4': 16.5 ppm	
3.0			Gravelly Lean Clay (CL) 1.0 - 6.0' - red gray (5 YR 5/2), moist to wet, soft, little fine to medium angular gravel				
4.0							
5.0							
8.0			Clayey Sand (SC) 6.0 - 13.5' - reddish brown (5 YR 3/2), wet, medium density, fine to coarse sand, some clay				
10.0							
12.0							
15.0							
16.0	1.5	Collect samples IS17DS70D1012, IS17DS70D1012MS, and IS17DS70D1012SD at 1050	Lean Clay (CL) 13.5 - 17.5' - gray (5 YR 5/1), moist to wet, very soft, trace fine sand				
18.0	1.0						
			Bottom of Boring at 18.0 ft bgs on 6/24/2014				

(CH2MHill, 2014)



PROJECT NUMBER: 387444	BORING NUMBER: IS17DP71D	SHEET 1 OF 1
SOIL BORING LOG		

PROJECT : NSF Indian Head, Site 17 LOCATION : Indian Head, Maryland
 ELEVATION : DRILLING CONTRACTOR : Parratt - Wolff
 DRILLING METHOD AND EQUIPMENT : Geoprobe, DPT

DEPTH BELOW EXISTING GRADE (ft)			SOIL DESCRIPTION	SYMBOLIC LOG	COPR	Sireta	Water level	PID (ppm)	WELL DIAGRAM
INTERVAL (ft)	RECOVERY (ft)	SAMPLE ID (TIME)							
0.0			Sandy Silt (ML) 0.0 - 1.0' - yellow red (5 YR 5/6), moist, firm, little fine to medium sand Gravelly Lean Clay (CL) 1.0 - 7.0' - reddish gray (5 YR 5/2) to gray (5 YR 5/1), wet, very soft, little fine to medium angular gravel	[Symbolic Log Pattern]				0-2': 0.0 ppm	
2.5								2-4': 0.2 ppm	
4.0								4-8': 7.9 ppm	
3.0								8-12': 78.4 ppm	
6.0			Clayey Sand (SC) 8.0 - 9.0' - very dark gray (5 YR 3/1), wet, medium density, some clay, fine to coarse sand	[Symbolic Log Pattern]				8-12': 78.4 ppm	
1.0		Collect sample IS17DS7 1D0810 at 0925						12-16': 2.6 ppm	
12.0			Lean Clay (CL) 12.0 - 17.5' - gray (5 YR 5/1), moist to wet, very soft, trace fine sand	[Symbolic Log Pattern]				12-16': 2.6 ppm	
3.0								16-20': 1.3 ppm	
16.0								16-20': 1.3 ppm	
1.5								Bottom of Boring at 18.0 ft bgs on 6/24/2014	
18.0									

(CH2MHill, 2014)



PROJECT NUMBER: 387444	BORING NUMBER: IS17MW14	SHEET 1 OF 1
SOIL BORING LOG		

PROJECT : NSF Indian Head, Site 17 LOCATION : Indian Head, Maryland
 ELEVATION : DRILLING CONTRACTOR : Parratt - Wolff
 DRILLING METHOD AND EQUIPMENT : Geoprobe DPT, HSA, DPT

WATER LEVELS : — START : 6/24/2014 END : 6/24/2014 LOGGER : C. Reed

DEPTH BELOW EXISTING GRADE (ft)	INTERVAL (ft)		RECOVERY (ft)	SAMPLE ID (TIME)	SOIL DESCRIPTION SOIL NAME, USCS GROUP SYMBOL, COLOR, MOISTURE CONTENT, RELATIVE DENSITY OR CONSISTENCY, SOIL STRUCTURE, MINERALOGY	SYMBOLIC LOG	Water level	PID (ppm)	WELL DIAGRAM
	Interval 1	Interval 2							
0.0					Sandy Silt (ML) 0.0 - 1.5' - dark red brown (5 YR 3/4), dry to moist, fine to coarse sand			0-2': 0.0 ppm 2-4': 0.0 ppm	<p>Stick-up Steel Casing with Bollards Bentonite Grout 2" PVC Solid Riser Bentonite Seal Sand 2" - 0.010" PVC Slotted Screen Bottom of Well at 13.9 ft bgs</p>
3.0					Silty Sand (SM) 1.5 - 3.0' - dark red gray (5 YR 4/2), moist, medium density, fine to coarse sand, many silt, wood fragments				
4.0					Poorly Graded Sand (SP) 4.0 - 6.0' - dark gray (5 YR 4/1), wet, medium density, fine to medium sand, little silt		4-6': 0.0 ppm 6-8': 3.7 ppm		
5					Lean Clay with Sand (CL) 6.0 - 12.0' - light reddish brown (5 YR 5/4), moist to wet, very soft to firm, some fine to medium sand			8-12': 2.8 ppm	
8.0									
10			4.0	Collect sample IS17SB190812 at 1500				12-16': 0.0 ppm	
12.0					Lean Clay (CL) 12.0 - 19.5' - reddish yellow (5 YR 6/6), moist, firm, trace fine sand				
15			3.0	Collect sample IS17SB191216 at 1505					
16.0									
20			3.5	Collect sample IS17SB191618 at 1510				16-20': 0.0 ppm	
20.0					Bottom of Boring at 20.0 ft bgs on 6/24/2014				

(CH2MHill, 2014)

APPENDIX B.2 Cross-Sections

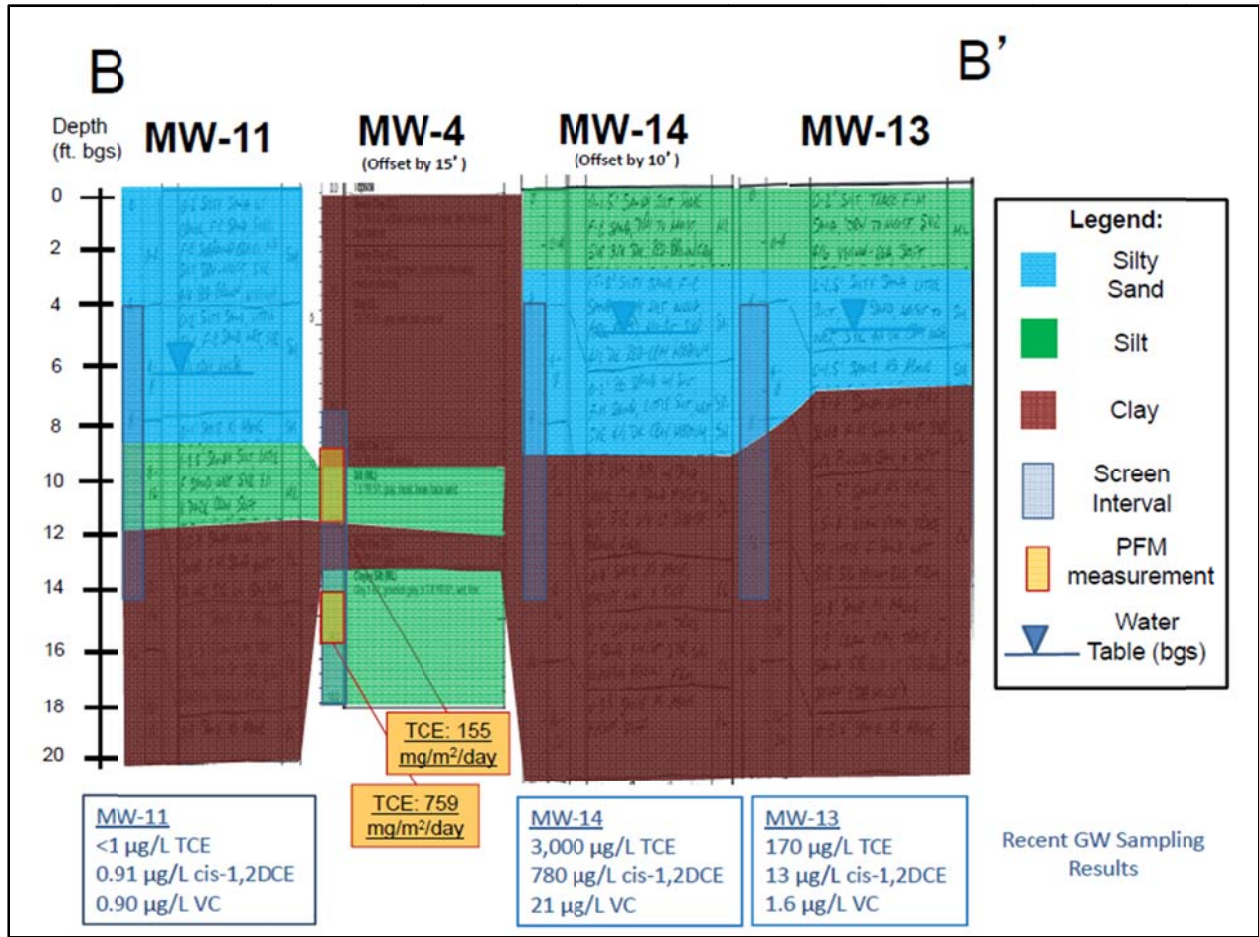

APPENDIX B.2
Soil and Groundwater Sampling Results, 2014

Groundwater Concentrations (ug/L)

	IS17MW04	IS17MW11	IS17MW12	IS17MW13	IS17MW14
TCE	400000	0.91 J	83000	170	2900
cis-1,2-DCE	130000	1 U	1900	13	920
VC	1600	0.9 J	1000	1.6 J	50 U

Soil Concentrations (mg/kg)

	IS17MW11			IS17MW12		
	8-12 ft bgs	12-16 ft bgs	16-18 ft bgs	8-12 ft bgs	12-16 ft bgs	16-18 ft bgs
TCE	0.0012 J	0.0009 J	0.0008 J	20	310	150
cis-1,2-DCE	0.001 J	0.0008 J	0.0008 J	2.2	2.2 U	1.7 J
VC	0.0017 U	0.0013 U	0.0012 U	0.14 J	2.2 U	2 U

	IS17MW13			IS17MW14		
	8-12 ft bgs	12-16 ft bgs	16-18 ft bgs	8-12 ft bgs	12-16 ft bgs	16-18 ft bgs
TCE	0.0006 J	0.0009 J	0.0007 J	2.8	3	4.1
cis-1,2-DCE	0.0013 U	0.0014 U	0.0013 U	0.1 J	0.087 J	0.15 J
VC	0.0013 U	0.0014 U	0.0013 U	0.13 U	0.13 U	0.13 U

Notes:

1. TCE = trichloroethene; cis-1,2-DCE = cis-1,2-dichloroethene; VC = vinyl chloride.
2. U = non-detect;

APPENDIX C SOLUTIONS IES TREATABILITY STUDY



TREATABILITY REPORT

FORMULATION OF A VEGETABLE OIL-BASED MATERIAL FOR CONTAMINANT FLUX REDUCTION BARRIERS

**Contaminant Flux Reduction Barriers for Managing Difficult-to-Treat Source Zones in Unconsolidated Media
(ER-201328)**

Prepared for:

Environmental Security Technology Certification Program
Arlington, VA

Prepared by:

Dr. Robert C. Borden, P.E., Dr. Bilgen Yuncu, P.E., and Shristi R. Shrestha
Solutions-IES, Inc.
1101 Nowell Rd., Raleigh, NC 27607

Poonam R. Kulkarni, P.E. and Dr. Charles J. Newell, P.E.
GSI Environmental Inc.
2211 Norfolk, Suite 1000, Houston, TX 77098

October 2014

EXECUTIVE SUMMARY

This report presents the results of a series of laboratory tests conducted as part of the project *Contaminant Flux Reduction Barriers for Managing Difficult-to-Treat Source Zones in Unconsolidated Media (ER-1328)*. This work was conducted to identify effective formulations for creating low permeability (K) barriers. An ideal formulation would be one that is:

- low cost;
- easy to inject;
- able to reduce the hydraulic conductivity (K) of sand by at least a factor of 10, preferably a factor of 100;
- persistent in the subsurface longer than typical vegetable oils; and
- slowly fermented thereby enhancing reductive dechlorination.

An initial list of potential amendments was generated based on chemical, physical, biological and handling characteristics of the materials and potential costs of application. Amendments considered included:

- 1) thixotropic emulsions;
- 2) hydrogenated oils;
- 3) divalent salts of long-chain fatty acids; and
- 4) mixtures of emulsified vegetable oil (EVO), sodium silicate (NaSi) and dibasic ester (DBE).

Mixtures of EVO, NaSi and DBE were identified as having the best potential for field application based on ease of injection, ability to reduce formation permeability, and cost. Based on this screening, several different combinations of EVO, NaSi and DBE were selected for further evaluation.

A series of laboratory studies were then conducted to determine:

- 1) application rate required to achieve the desired reduction in K;
- 2) the ease of distribution (by injection) in one-dimensional columns; and
- 3) gas production over time during injection tests

Falling head permeameter tests were conducted on different mixtures of EVO, NaSi, and DBE to determine the amendment application rate required to reduce the K of coarse sand. All treatments reduced K by approximately 5 orders of magnitude (i.e., to less than 0.01 m/d) compared with an untreated control. However, K later increased in two of the treatments. This increase in apparent K is believed to be due to shrinkage of the grouted material when exposed to air at the bottom of the column.

Laboratory injection tests were then conducted to: 1) determine the injection pressures and flow rate expected to occur during injection of the formulation into sand; and 2) measure the impact of the injection on K. Clear PVC columns were packed with coarse sand and saturated with water. The different amendment formulations were injected into the columns and monitored to evaluate

ease of injection. The effective K of each column was measured before amendment injection and at 40 hours, 1 week and 4 weeks after injection. There was no measurable pressure buildup during the injection phase, indicating this amendment formulation can be easily injected in permeable aquifer material. Formulations containing 7.5% sodium silicate and either 5 or 10% EVO did not set up properly due to mixing with other water in the columns, and these formulations were eliminated from consideration. A traditional grout formulation containing 30% NaSi was most effective in lowering K. However, formulations containing either 5% or 10% EVO and 10% NaSi also performed well, reducing K by 1 to 4 log units. As 5% EVO mixture performed slightly better than the 10% formulation, it was chosen as the final formulation for field application.

Batch fermentation tests were established to measure gas (CH₄ and CO₂) production rates over time as an indication of relative biodegradability of the different formulations. At 112 days after start up, all amendments produced significantly more gas than untreated controls. Gas production in bottles treated with only NaSi and DBE is believed to be due to anaerobic fermentation of the DBE. These batch incubations will be monitored for at least 6 months to evaluate long-term fermentation of the different materials.

1.0 INTRODUCTION

In the demonstration project *Contaminant Flux Reduction Barriers for Managing Difficult-to-Treat Source Zones in Unconsolidated Media (ER-1328)*, flux reduction materials will be injected in the subsurface to form a barrier around a treatment zone in order to enhance biodegradation of chlorinated solvents.

The overall project involves three key tasks as follows:

Task 1: Flux Reduction Material Formulation: Vegetable oil-based formulations will be created and tested in lab-scale batch and column studies to determine the most effective formulation for creating barriers. Factors that will be taken into account include: stability, viscosity, decrease in permeability of soil, and costs of the material. The results of the lab-scale tests will be used to select one vegetable oil-based formulation for the small-scale field demonstration (Task 2).

Additionally, the extensive scientific literature regarding properties and field injection protocols of silica gel (SG) will be used to select i) the most cost-effective SG material (either sodium silicate or colloidal silica), and ii) the specific SG electrolyte/reagent necessary for subsurface gelling. The results of this evaluation will be used to select one type of silica gel for the small-scale field demonstration (Task 2).

Task 2: Small-Scale Field Demonstration, Technology Implementation: Two treatment cells (5-foot radius) will be established, testing two different flux reduction materials in a clean zone at the site: a vegetable oil-based formulation determined from Task 1, and a silica gel solution. Each treatment cell will consist of: i) a perimeter of injected flux reduction material, ii) a pumping test well at the center, and iii) an observation well directly upgradient of the treatment barrier. A constant head, variable flow pumping test will be conducted both before and after the establishment of treatment barriers in order to determine the reduction in transmissivity (T).

Task 3: Field Demonstration, Large-Scale Demonstration: A larger scale technology demonstration will be completed using the best performing material identified during the Task 2 field work (i.e., either a silica-based flux reduction material or a vegetable oil-based flux reduction material). At this site, it is anticipated that an area of up to 70 ft. by 70 ft. will be treated. Six observation wells will be drilled in the treatment area in order to i) take mass flux measurements using Passive Flux Meters at 3 wells; ii) take measurements of water levels in order to calculate the hydraulic gradient, and iii) take measurements of geochemical parameters such as dissolved oxygen, nitrate, sulfate, and oxidation reduction potential (ORP) . Both pre-treatment and post-treatment data will be collected to determine the change in: mass flux, hydraulic gradient, and geochemical parameters.

This Technical Report details the laboratory phase (Task 1) of the vegetable oil based formulation.

1.1 BACKGROUND

As part of Task 1 of this demonstration, several different flux reduction formulations were evaluated, and two specific formulations were selected for the small-scale field demonstration. The materials and evaluation methods used were as follows:

- 1) Silica Gel Material: Silica gel material consisting of either sodium silicate or colloidal silica. Because these silica-based compounds are extensively used in the construction dewatering field, no lab work was required as part of this material screening process.
- 2) Vegetable Oil-Formulation: Vegetable oil-based flux reduction agents were evaluated. Because using oil as a flux reduction agent is a novel application, laboratory and batch studies were conducted by Solutions-IES to screen this material.

This Technical Report highlights the scope of work and formulation of the vegetable oil-based material to be field tested under Task 2 (and possibly Task 3) of this project.

1.2 OBJECTIVE OF TASK 1 LAB STUDY: FORMULATION OF A VEGETABLE OIL-BASED MATERIAL

Objectives for the demonstration project were to: 1) evaluate two different flow reduction materials, edible oils and silica gels, in terms of cost, ease of installation, and effectiveness; 2) determine cost factors of this technology relative to conventional remediation strategies for chlorinated solvents in terms of key unit costs (\$ per cubic yard and \$ per acre); 3) determine if a 1 order of magnitude or greater reduction in mass discharge from actual treatment zones is achievable using this flux reduction technology; and 4) demonstrate benefits from electron acceptor diversion around chlorinated solvent treatment zones.

Vegetable oil-based formulations were created and tested in lab scale batch and column studies to determine the most effective formulation for creating barriers. Factors that were taken into account include: stability, viscosity, decrease in permeability of soil, and costs of the material.

Specifically, the laboratory studies entailed:

1. Testing various vegetable oil based amendments to select two formulations for further evaluation
2. Formulations were then evaluated by:
 - Determining the required application rate
 - Injection tests
 - Fermentation tests

An ideal formulation would be one that is: (a) low cost; (b) easy to inject; (c) reduces the permeability of sand by at least a factor of 10, preferably a factor of 100; (d) persistence in the subsurface greater than typical vegetable oils; and (d) slowly ferments enhancing reductive dechlorination.

2.0 TECHNOLOGY

2.1 TECHNOLOGY DESCRIPTION

The overall technology demonstration involves the testing of a flux reduction material incorporating an emulsified vegetable oil (EVO). By injecting these materials to form a barrier around a treatment zone, groundwater flow carrying competing electron acceptors will be diverted, resulting in an enhanced reductive dechlorination zone (Newell et al., 2003).

2.2 ADVANTAGES AND LIMITATIONS OF THE TECHNOLOGY

Advantages:

- Drastically reduces flux of contaminant out of, and flux of competitive electron acceptor into treatment zone;
- Application in the field is similar as a standard injection;
- Long lasting material;
- Fairly low cost material.

Limitations:

- Time limited injection;
- Impossible to treat all of the aquifer material (i.e., it will treat high K zones);
- Have to surround the entire source area to be really effective in cutting groundwater flux off.

3.0 PERFORMANCE OBJECTIVES

Under Task 1, laboratory treatability studies were conducted by Solution-IES to identify a vegetable oil-based formulation that meets the following criteria:

1. Formulation can be injected through a conventional well screen or direct push injection rod and distributed at least 0.3 m away from the injection point in sand at a pressure less than 25 psi and flow rate of at least 0.25 L per m of screen.
2. Once distributed, the formulation will reduce the permeability of sand by at least a factor of 10, preferably a factor of 100.
3. Persistence in the subsurface that is greater than typical vegetable oils.
4. Slowly ferment to methane indicating the slow production of acetate and/or H₂ which could be used to support reductive dechlorination.

4.0 TEST DESIGN

4.1 IDENTIFICATION OF AMENDMENTS

An initial list of potential amendments was generated based on chemical, physical, biological and handling characteristics of the materials and potential costs of application. The amendments considered for testing included:

- a. Thixotropic emulsions - Mixtures with high starting viscosities that lower when energy is put into the material, allowing them to be pumped into an aquifer. Characterized by high material costs (\$50/ft³ aquifer) and limited radius of influence as viscosity increases with distance from the injection point.
- b. Hydrogenated oils - Oils that are a solid at room temperature. These materials require heating prior to injection, and may suffer limited radius of influence similar to thixotropic emulsions as they cool during injection. Material costs are moderate at \$4-8/ft³ aquifer.
- c. Divalent salts of long-chain fatty acids (soap) - Soap scum is formed when long-chain fatty acids react with divalent cations (Ca⁺², Mg⁺²) and precipitate. Soap scum can be precipitated *in situ* through injection of a concentrated soap formulation and dissolved or colloidal Ca or Mg. Set-up time can be reduced by mixing reagents above ground prior to injection, or increased by injecting reagents separately and allowing them to mix in-situ. Costs are comparable ranging from \$2-10/ft³ aquifer.
- d. Mixture of EVO, Sodium silicate and dibasic ester – Material has low viscosity prior to set-up. Set-up time can be controlled by varying the amount of dibasic ester (DBE) included in the formulation. Commercially available DBE is an ester of a dicarboxylic acid. Injection would very similar to typical geotechnical grouting practices, and material cost would be low at \$2-3/ft³ aquifer.

The amendments listed above were pre-screened to identify at least two formulations that have good potential for successful field application. Following the screening, it was determined that the most practical option was EVO mixed with sodium silicate due to a combination of cost, ease of use, and reliability. Several formulations consisting of varying combinations of EVO, sodium silicate, and DBE were then evaluated to determine:

- i) application rate required to achieve the desired reduction in permeability;
- ii) injection tests to evaluate the ease of distribution in one-dimensional columns;
- iii) fermentation tests to measure gas production over time.

4.2 DETERMINATION OF REQUIRED APPLICATION RATE

Treatment formulations were first tested to determine the amendment application rate (i.e., amendment loading) in grams formulation per gram sand required to reduce the permeability of sand by at least a factor of 10, and preferably by a factor of 100. Falling head tests were conducted to measure the permeability of the sand with and without the amendments. In preliminary work, we determined that setup time could be controlled by varying the quantities of sodium silicate (NaSi), dibasic ester (DBE), EVO and water in the formulation. However, gelling reliability was reduced when the weight percentage of sodium silicate was less than

7.5%. The mixtures listed in Table 1 were selected for further testing based on their relatively low material costs combined with substantial reductions in permeability.

Table 1 - Falling Head Tested Formulations				
Formula #	EVO	Na₂SiO₃	DBE	Water
	wt%	wt%	wt%	wt%
E10-S10	10%	10%	1.8%	78%
E10-S75	10%	7.5%	2.5%	80%
E5-S10	5%	10%	1.8%	83%
E5-S75	5%	7.5%	2.5%	85%
E0-S10	0%	10%	1.8%	88%
E0-S75	0%	7.5%	2.5%	90%

4.2.1 Materials

Permeability tests were conducted by packing #2 filter sand (Drillers Service, Inc., <http://www.dsienv.com/FilterSand-DSI.htm>) in 7.5 cm diameter by 60 cm long PVC columns. The columns were constructed and maintained in the Civil, Construction and Environmental Engineering Laboratory at North Carolina State University in Raleigh, NC. The materials used in the formulations were obtained from the following sources:

- Dibasic Ester, Flexisolve Lot # WB 12894131
- De-aired water
- Sodium Silicate, PQ Corporation, CAS # 1344-09-8
- EOS Pro , CBL # 72064, 822/13, PO # 512336

4.2.2 Falling Head Test Procedure

Columns were prepared from 7.5 cm x 60 cm long sections of PVC pipe. Filter sand was added to the column in 2.5 cm lifts, compacted with ten blows of a standard compaction hammer (AASHTO Method T180, 2012), and then another lift was added up to a depth of 7.5 cm. Once the sand reached the target depth, 1000 mL of the treatment formula was slowly added, allowing the amendment solution to permeate the sand. A small hole was drilled in the side of the column immediately above the sand surface to allow excess amendment solution to overflow from the columns. Once fully saturated, the hole was sealed and the columns were left overnight to allow each treatment to gel. After 24 hours, tap water was added to the top of the column, providing a total of 61 cm of head at the start of the test. The hydraulic conductivity (K) of each column was determined by measuring the change in water level in the column over time using Equation 1 below.

$$K = \frac{2.3L}{t} \log\left(\frac{h_1}{h_2}\right) \quad \text{Eq. 1}$$

Where:

- K = permeability (cm/s)
- L = sand depth (cm)

- t = elapsed time (s)
- h_1 = initial water level (cm)
- h_2 = new water level (cm)

The falling head tests were conducted over a period of 100 hours. Figure 1 below shows the falling head test equipment used during this procedure.

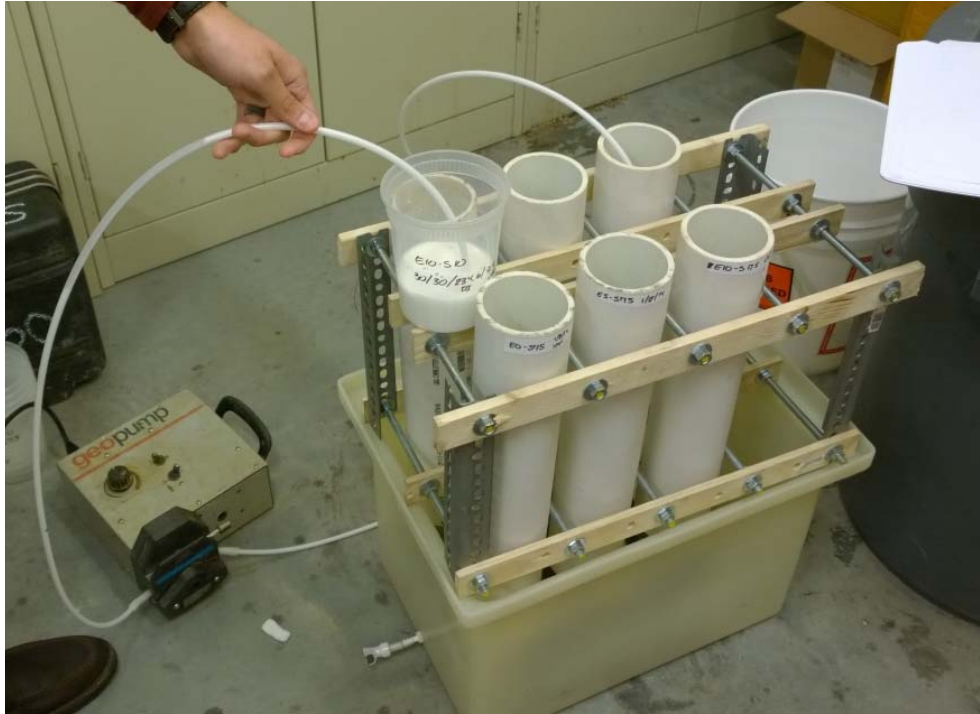

Figure 1. Falling head test equipment showing procedure for loading a column with a gelling formulation

4.2.3 Results

Falling head tests conducted on control columns packed with clean #2 filter sand yielded K values between 580 and 605 meters per day (m/d). The control K was used as the basis of comparison with the gel combinations.

The gel formulation tests were started after allowing each gel to set in the columns for 24 hours, and monitored for up to 100 hours after gel set time. The results of the falling head tests are shown below in Figure 2. All treatments lowered the initial K by approximately 5 orders of magnitude (i.e., to less than 0.01 m/d) compared with the control #2 filter sand (Table 2). However, the permeability later increased in two of the treatments (E5-S10 and E0-S10) at 40 to 45 hours after start of the test.

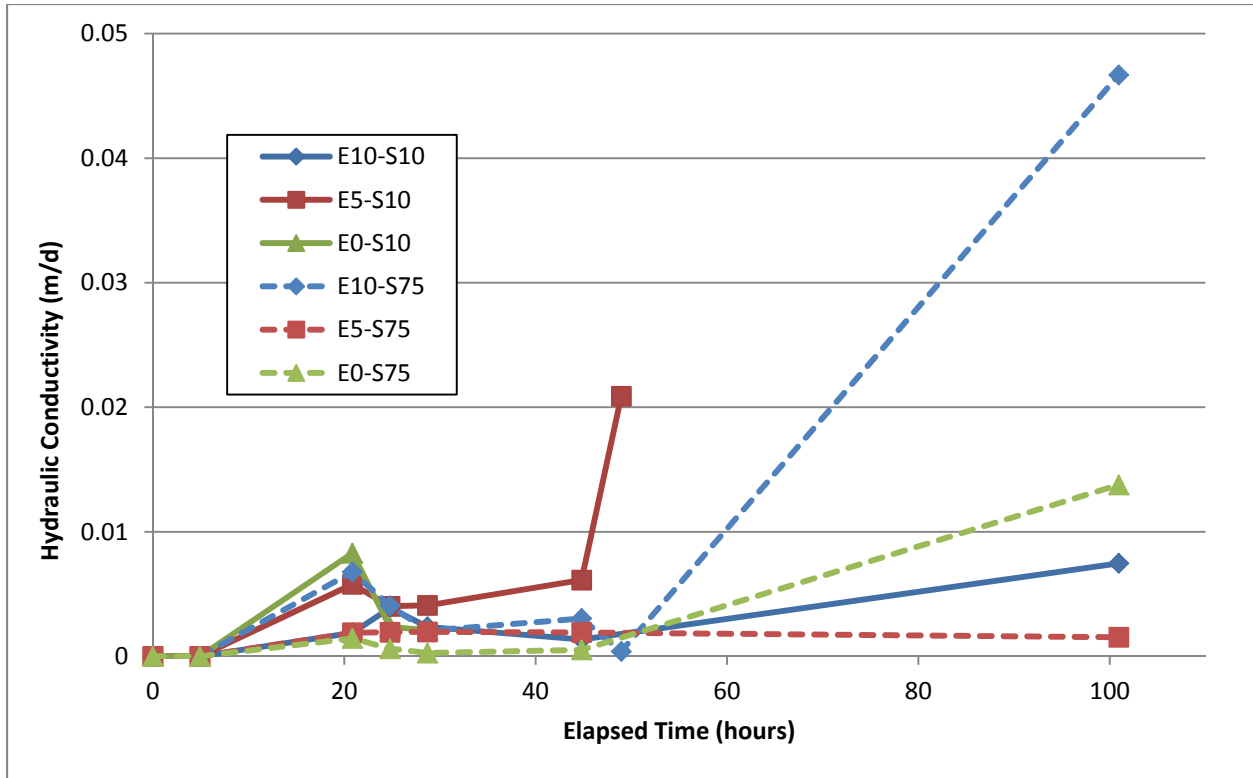

Figure 2. Graph of hydraulic conductivity versus time for falling head tests.

Table 2 Falling head test results				
Treatment	After 24 hours		After 100 hours	
	K (m/d)	Log Reduction in K	K (m/d)	Log Reduction in K
Control	600	--	600	--
E10-S10	0.004	5.2	0.007	4.9
E10-S75	0.004	5.2	0.05	4.1
E5-S10	0.004	5.2	Column failed	
E5-S75	0.002	5.5	0.002	5.6
E0-S10	0.002	5.4	Column failed	
E0-S75	0.0006	6.0	0.01	4.6

Figure 3 below shows the sand after removal from the falling head test columns. In the left image you can see the intact gelled sand, and on the right you can see pore space filled with the white gel formulation.



Figure 3. Extracted #2 filter sand from falling head columns.

The falling head test results showed that all of the potential formulations are initially effective in reducing the permeability of the sand. However, leakage increased over time. After removing the soil from the columns, it was evident that water was able to travel around the edge of the column, between the soil matrix and the PVC column, resulting in some short circuiting of the treatment. Sodium silicate based grouts are reported to shrink over time which may have caused the grouted sand to pull away from the PVC pipe, resulting in the apparent increase in hydraulic conductivity over time. This shrinkage was probably increased by exposure of the column bottom to air and associated drying.

4.3 INJECTION TESTS

Injection tests were conducted to: 1) determine the injection pressures and flow rate expected to occur during injection of the formulations into sand; and 2) the impact of the injection on permeability.

4.3.1 Equipment

The injection tests were conducted in 28 cm long x 2.59 cm diameter PVC columns as seen in Figure 4. The columns were packed under saturated conditions in increments by adding 1 ml deionized (DI) water followed by 2 grams #2 filter sand followed by compaction by repeated tamping with a 1-cm diameter metal rod. After packing, the columns were weighed and porosity was determined using empty weight, packed weight, column volume and specific gravity of water and sand. Once packed, the columns were flushed with at least three pore volumes (PV) of de-aired DI water to remove entrapped air or until hydraulic conductivity stabilized, whichever was greater.



Figure 4. Empty and packed PVC columns used for injection tests.

4.3.2 Procedure

The K of the simulated aquifer material (i.e., #2 filter sand packed in each column) was measured before amendment injection and at 40 hours, 1 week and 4 weeks after injection. Permeability was measured by applying a constant head to the top of the column, while discharging the column outflow to a reservoir held at a constant elevation. The total volume of effluent produced over time was recorded and used to calculate hydraulic conductivity using the terms of Equation 2 below.

$$K = \log(Q L) / (A t \Delta H) \quad \text{Eq. 2}$$

Where:

- Q = volume discharged from column (cm³)
- L = sand depth (cm)
- A = cross-sectional area of column (cm²)
- t = Elapsed time (s)
- ΔH = difference in water level across column (cm)

Columns were built for up-flow injection. A syringe pump was used for injection of the flux reduction material at a rate of 2.5 mL/min (Figure 5). Injections were completed in the following sequence:

- 0.2 pore volumes (PV) of de-aired DI water,
- 0.5 PV of formulation,
- 0.3 PV of de-aired DI water

After the injection was complete, valves were closed and the columns were allowed to sit for 40 hours to allow the amendment formulation to set. Prior to measuring K , inlet filter screens were replaced in all columns to reduce the potential for inlet clogging. Throughout the injection procedure, injection pressure was monitored at the column inlet with a pressure gauge (0 to 15 psi in-line gage). There was no measurable pressure build-up in any injection.

The constant head test was conducted at 40 hours, 1 week, and 4 weeks after injections to assess changes in permeability over time. After 4 weeks, water with food color dye was injected

through the column to help visualize how flow through the flux reduction material occurred. The flux reduction materials tested included 10% sodium silicate mixtures with 5 and 10% EVO. A formulation consisting of 30% sodium silicate, similar to concentrations typically used for geotechnical grouting was run for comparison. Column tests were also run with formulations containing 7.5% sodium silicate and either 5 or 10% EVO. However, these formulations did not set up properly due to mixing with DI water and the experiments were terminated.

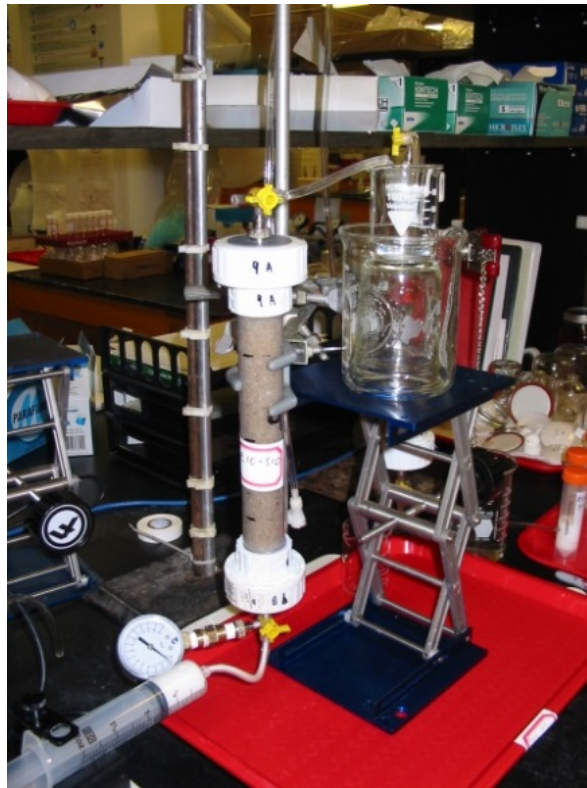

Figure 5. Pressurized, up-flow injection of treatment formulation in column.

4.3.3 Results

Results for injection tests show that all of the materials tested were easily injected into the test columns. The injection pressure never exceeded the minimum detectable pressure of 1 psi, indicating no significant pressure build up in any injection.

Formulations containing 7.5% NaSi did not setup properly due to dilution of the amendment with water. As a result, the 7.5% NaSi formulations were eliminated from further consideration. Table 3 shows measured changes in K for formulations containing EVO and 10% NaSi at 40 hr, 1 week and 4 weeks after amendment injection.

Table 3 - Constant Head Test Summary			
Formulation	E0-S30	E5-S10	E10-S10
Gel Time (hours):	0.5	18	7
Elapsed Time	<i>Log Unit Reduction</i>		
40 hours	No Flow	2.8	1.3
1 week	No Flow	3.0	1.3
4 weeks	No Flow	4.5	1.7

As expected, the traditional grout formulation with 30% sodium silicate was most effective in lowering permeability of the sand compared to the formulations with lower percentage (10%) of sodium silicate. The 10% silica gel formulations that included EVO also performed well, as evidenced by 1 to 4 log unit reductions in permeability. There was also little or no change in K over time, indicating grout shrinkage was not significant. The reduced shrinkage in these tests compared to the constant head tests may be because the columns were kept saturated throughout the monitoring period, reducing drying. The 10% sodium silicate-EVO mixtures appeared to gel more slowly than pure silica gel (7 to 14 hours compared to <1 hour), which would allow for these mixtures to be used in conventional injections.

Dyed-water injections at 1-month after initial injections showed that most of the pore space in the treated zone is completely clogged, with short circuiting through one or two preferential flow paths. Figure 6 below shows an example of a column following dyed-water injection. A single preferential flow path is visible around the edge of the column. When the column was sectioned, there was no visual evidence of dye breakthrough in the center of the column.

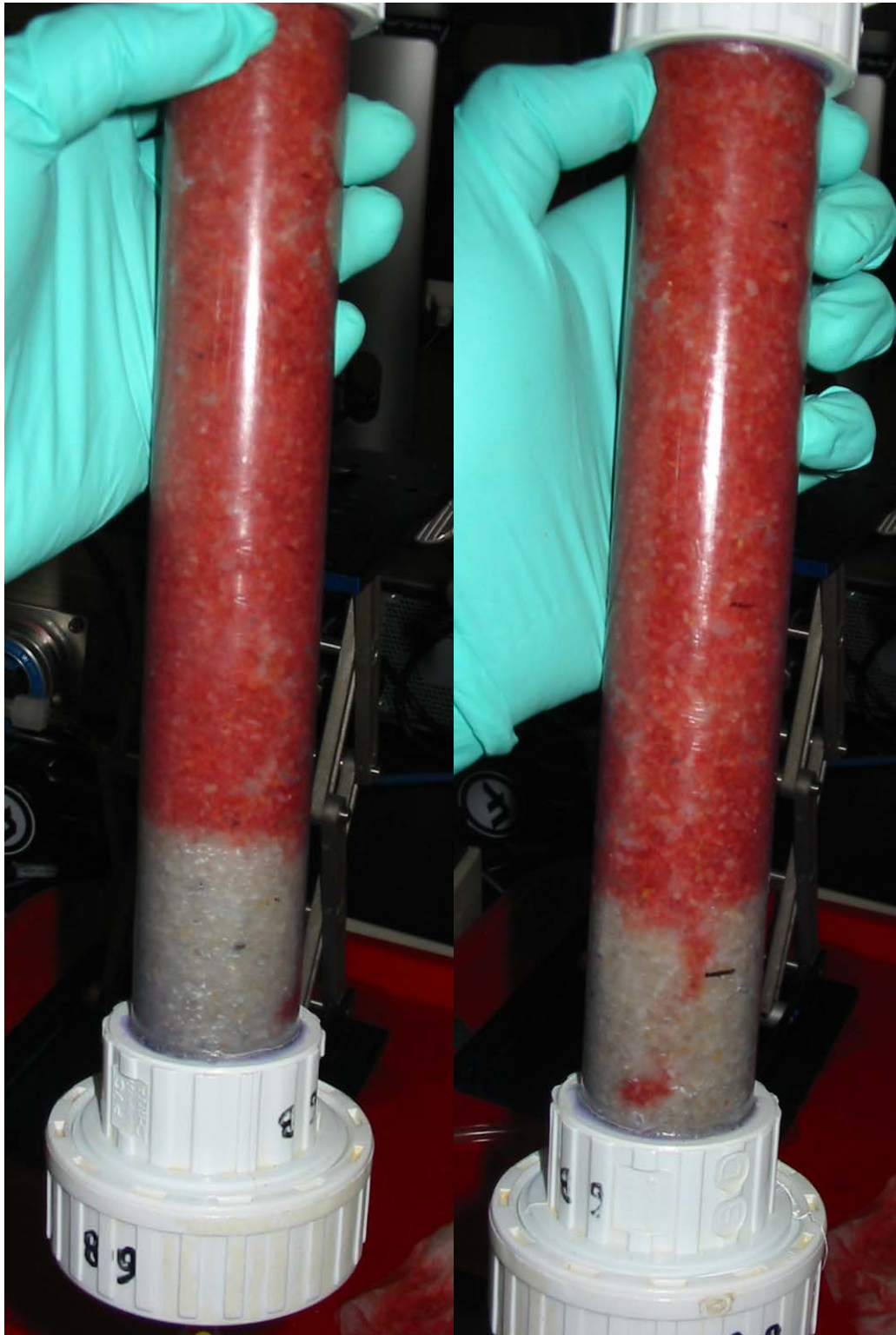

Figure 6. Example of a treated column following dyed water injection at 1 month. The columns were operated in a downflow mode during dye addition. The dye free zone at the bottom of the column is the area treated with the treatment formulation.

4.4 FERMENTATION TESTS

Batch fermentation tests were run to measure gas (CH₄ and CO₂) production rates over time as an indication of relative biodegradability of the different formulations.

The experiments were designed to:

- (a) Confirm that gas production from the amended bottles is greater than the controls;
- (b) Confirm the gas production rate is similar or slower than pure soybean oil so the material will be long-lasting in the subsurface; and
- (c) Use gas production rates to qualitatively assess the expected persistence of the formulation in the subsurface.

These fermentation tests were conducted following procedures similar to those used by Borden and Rodriguez (2006).

4.4.1 Materials

The batch incubations were constructed in 160 mL serum bottles with the organic amendment, #2 filter sand, 100 mL of nutrient/buffer medium (Borden and Rodriguez, 2006) and 2ml of inoculum. The inoculum was prepared with a mixture of 94% nutrient/buffer medium, 5% anaerobic digester sludge (Cary WWTP, NC) and 1% supernatant from EOS Pro microcosms. The inoculum mixture was prepared 2 weeks in advance, allowing residual methane production to slow. The tested substrates are listed below. Each treatment was run in triplicate:

- a. Control (No substrate)
- b. E5-S10
- c. E10-S10
- d. E0-S10
- e. Soybean oil
- f. EOS Pro Emulsified Vegetable Oil

To simulate conditions that might occur in the subsurface, the substrates containing sodium silicate (E5-S10, E10-S10, E0-S10) were mixed with filter sand and placed in petri dishes (Figure 7). After allowing these mixtures to set for 24 hours, small cubes of each sand-amendment mixture were added to the bottles to provide 0.2 g of fermentable material. Nutrient and buffer medium was then added to each bottle and the headspace was flushed with nitrogen (N₂) gas for 5 minutes and sealed with a thick rubber stopper. Once sealed, 2.0 mL of the mixed inoculum was added to each bottle (Figure 8). For non-gelled substrates (control, soybean oil, and EVO), 0.2 g of substrate was added directly to the bottles. All bottles contained a total of 50 g #2 filter sand.



Figure 7. Gelled substrates for microcosms.



Figure 8. Microcosm bottles.

Microcosm bottles were incubated in the dark at 37 °C to assess the total volume of gas produced (primarily CH₄ and CO₂). Gas production was monitored weekly for the first month and then bi-weekly using a wetted glass syringe.

4.4.2 Results

Figure 9 shows the cumulative gas production versus time for the different experimental treatments. Results shown are the average of triplicate incubations for each treatment. At 112 days after the start of incubation, the E5-S10 treatment had produced significant amounts of gas with lower production from the E10-S10 and E0-S10 treatments. The large amount of gas produced in the E0-S10 treatment is presumably from the 1.8% DBE included in this treatment. These incubations will be monitored through the remainder of the project period with final

results included in the project final technical report. We anticipate that gas production from the E0-S10 incubations will slow over time as the easily biodegradable DBE is consumed.

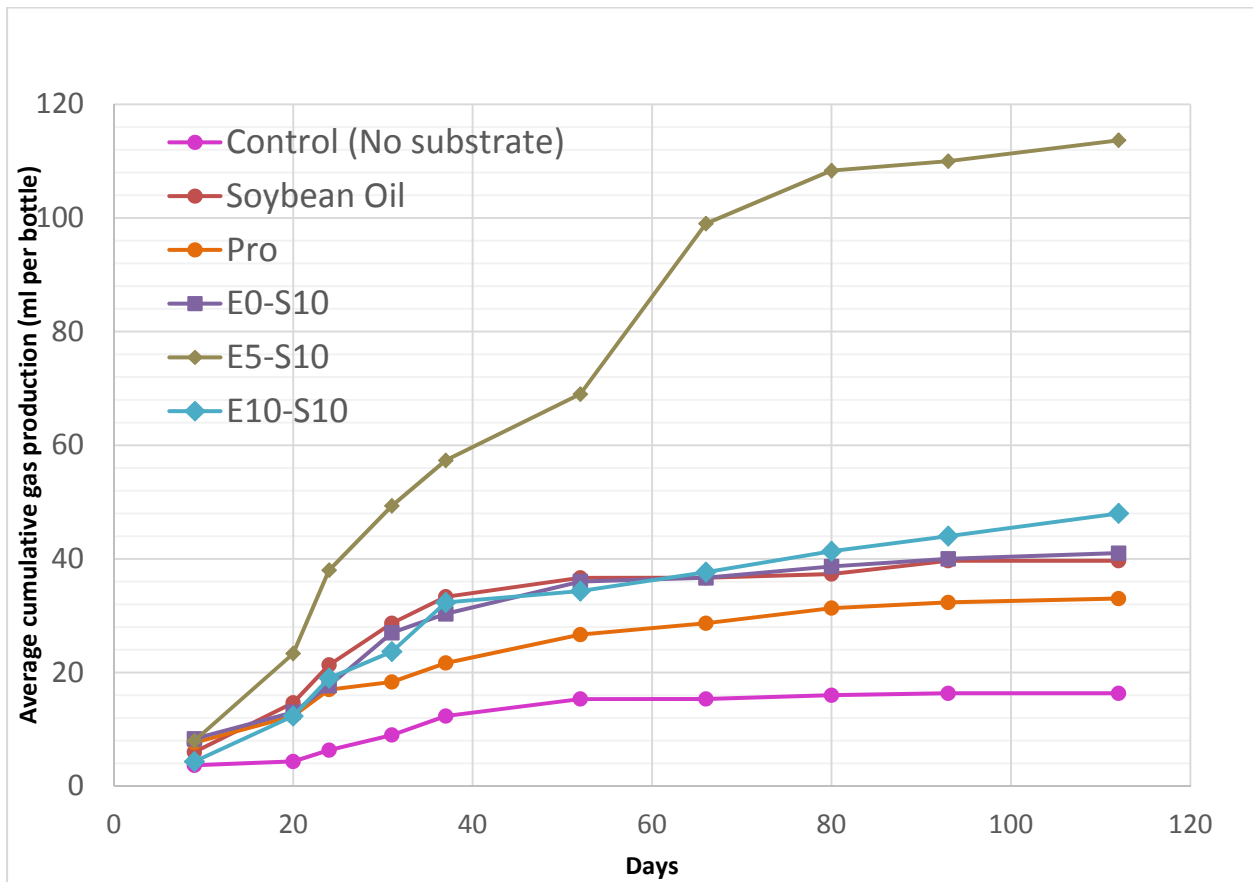

Figure 9. Average cumulative gas production versus time for different experimental treatments.

5.0 DISCUSSION

Several different mixtures of EVO, NaSi, DBE and water were tested to evaluate their suitability for use as a grout to reduce aquifer permeability and also to provide fermentable organic substrate that could support reductive dechlorination.

Permeability reduction tests showed that both formulations of 5 and 10% EVO listed as E5-S10 and E10-S10 (Table 1) reduced the permeability of the #2 filter sand by at least one log unit, which meets the test objective. The 5% EVO formulation performed slightly better, giving a 3 to 4 log unit reduction. Hence, the formulation was chosen as the final formulation: 5% EVO, 10% Sodium Silicate, 1.8% Dibasic Ester, and 83% water.

All sodium silicate – EVO formulations were effective in reducing permeability of tested soils. A potential advantage of the EVO-NaSi formulation is the longer gel time, which would allow for traditional injection technology to be used, reducing drilling and labor costs. Addition of the EVO is also expected to enhance long-term biodegradation of anaerobically biodegradable contaminants.

6.0 REFERENCES

- AASHTO, 2012. *Moisture-Density Relations of Soils using a 4.54-kg (10-lb.) Rammer and a 457-mm (18-in.) Drop*, AASHTO T-180-10 (Method D-Modified), American Association of State Highway and Transportation Officials, Washington, DC.
- Borden, R. C. and B. Ximena Rodriguez, Evaluation of Slow Release Substrates for Anaerobic Bioremediation, *Bioremediation Journal*, 10(1-2):59-69, 2006.
- Newell, C., C. Aziz, C., and G. Cox, 2003. *Enhanced Anaerobic Treatment Zones in Groundwater*, U.S. Patent No. US 6,562,235 B1. United States.

APPENDIX D RESPONSES TO ESTCP COMMENTS

**APPENDIX D
ESTCP QUESTIONS AND REPSONSES**

QUESTION 1: It seems possible that by blocking groundwater flow to part of an aquifer, there may be unintended consequences to the surrounding area. Please discuss potential side effects of this technology and how they may be assessed during the demonstration.

Response: To address this issue, we have divided the unintended consequences into three separate questions:

- a. *Could a flux reduction barrier result in excessive groundwater mounding upstream of the barrier?*

Answer: Two lines of evidence indicate that excessive upgradient mounding would not be a problem. First, numerous (likely hundreds) of slurry wall enclosures have been constructed across the country, and we are not aware of any anecdotal reports of excessive mounding in the upgradient direction that have caused any problems. Second, our groundwater modeling indicated that at most only 0.05 feet of upgradient mounding could be expected under typical situations, a level that should not cause any negative impacts. To investigate the mounding, an additional piezometer could be installed upgradient and the change in water level before and after construction of the flux barrier could be measured.

- b. *Could a flux reduction barrier reduce the yield of a nearby groundwater pumping well?*

Answer: The short answer is a flux barrier would not reduce flow to a groundwater pumping well except in very rare, preventable situations. The conceptual model is similar to a stream: if one places a large stone in the stream, the water will flow around the rock and any water supply withdrawal downgradient or side gradient will not be compromised. Figure 1 below shows how quickly the groundwater streamlines wrap around the barrier, and that normal groundwater flow is restored up to 90 feet downgradient of the barrier.

One theoretical case where a vertical barrier could reduce the yield of a nearby groundwater pumping well would be in a case of small buried valley aquifer, where the barrier would extend across the entire buried valley. This would cause the groundwater to flow in some other direction and potentially reduce well yield. This situation would require a combination of an extremely large barrier in a relatively rare hydrogeologic setting, and be easily recognizable beforehand, so in practice well yields would not be affected by the construction of a barrier.

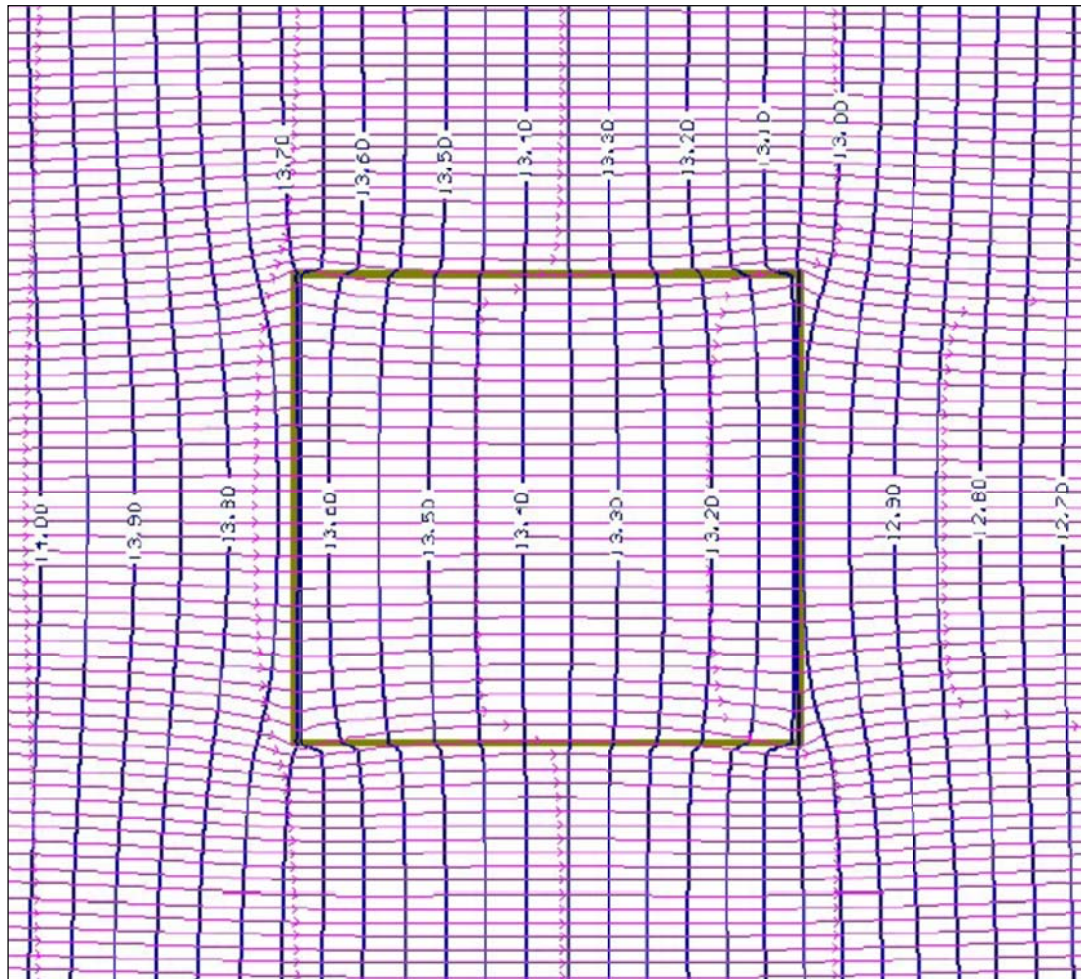

Figure 1: Simulation of Groundwater Flow Around Constructed Barrier. Note: (---) depicts flux reduction barrier, (blue lines) indicate equipotential lines and (pink arrows) show groundwater flow pathlines.

- c. *Could a flux reduction barrier restrict flow to the degree that infiltration would cause groundwater elevations to increase inside the barrier and affect subsurface structures, such as basements?*

Answer: Groundwater elevations would not increase significantly inside the barrier. For instance, for a $\frac{1}{2}$ acre enclosure with sandy surficial soils/vadose zone and an annual precipitation rate of 50 in/yr, the total infiltration is approximately 0.3 gpm (Weidemeier et al., 1999) within the site barrier. Assuming the hydraulic conductivity is 1×10^{-4} cm/s inside the barrier, the additional hydraulic gradient required to move this flow through the barrier is 0.07 ft/ft. Thus, for a barrier width of approximately 2 ft, this translates to a change in hydraulic head of 0.14 ft, or 1.6 inch. Essentially, for a typical site and precipitation rate, the change in groundwater elevation inside the barrier would be minor, and is not expected to affect subsurface structures.

QUESTION 2: Will there be more potential for vapor intrusion if the technology is implemented under an active building?

Analysis: This question was analyzed from two perspectives:

1. An analysis of the potential increase in groundwater elevation at a hypothetical site that includes: leaky barriers and upwelling;
2. Engineered factors to add additional safety factors; and
3. Two indirect ameliorating factors (change in mass discharge, and degradation of chlorinated solvent contaminants in the vadose zone).

Potential Groundwater Level Increase from Barrier

First, the process we envision will not increase the depth to the water significantly. The barriers are not designed to be completely impermeable, and some flow through the barrier is expected.

Our conceptual model is that groundwater flow alone will not cause the potentiometric surface to increase over the highest groundwater elevation in the vicinity of the barrier (i.e. within a short distance upgradient of the barrier):

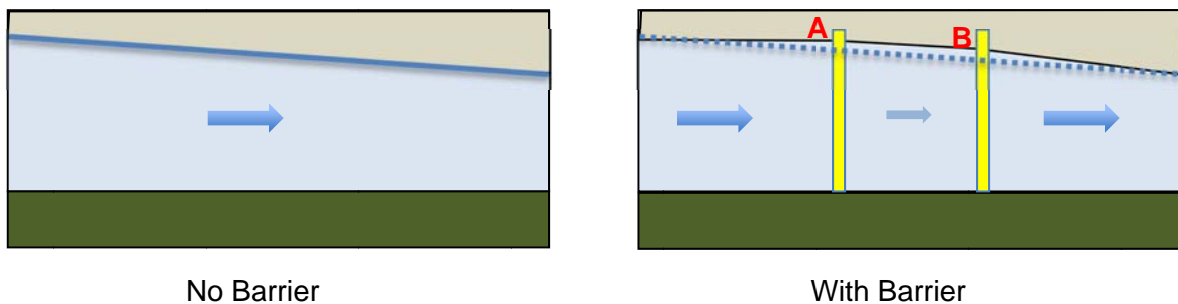

Qualitative Assessment

The increase with groundwater elevation at **Point A** is the groundwater elevation a short distance upstream. As demonstrated in the MODFLOW modeling below, this distance upgradient is fairly short, tens or maybe hundreds of feet, but not miles. When this is applied to typical hydraulic gradients in shallow groundwater plumes (1 foot per hundred feet or less) the increase in water level at **Point A** above is limited.

Recharge into the containment zone will result in higher water levels inside the barrier, with the highest elevation increase at **Point B**. However, our experience is that at most contaminated source zones groundwater recharge is a relatively small percentage of the water balance at any site. The reason for this is the amount of recharge upgradient of the source zone that is carried by the groundwater flow in the aquifer is usually much greater than the recharge through the source area alone. A barrier will reduce the

natural flow by 90 to 99%, but at many sites the remaining flow will still be greater than the recharge. The water level within the barrier will find the equilibrium level so that the inflow matches the outflow. Our conceptual model suggests this will be a relatively small increase in groundwater elevation.

MODFLOW Modeling

These qualitative factors describe the project team’s understanding of the barrier system flow regime. To provide a quantitative estimate of the groundwater level increase at a hypothetical site, a six layer system was modeled in MODFLOW. The top four layers represent a heterogeneous system with variable hydraulic conductivities of 10^{-2} cm/sec, 10^{-4} cm/sec, 10^{-2} cm/sec, 10^{-4} cm/sec, respectively, each 10-feet thick. The entire system is underlain by a 10^{-6} cm/sec clay which in turn is underlain by an uncontaminated sand unit.

Model Layer	K (cm/sec)	K _{wall} (cm/sec)	K/K _{wall} Ratio	Layer Type
Layer 1	10^{-2}	10^{-8}	10^{+6}	Convertible
Layer 2	10^{-4}	10^{-10}	10^{+6}	Confined
Layer 3	10^{-2}	10^{-8}	10^{+6}	Confined
Layer 4	10^{-4}	10^{-10}	10^{+6}	Confined
Layer 5	10^{-6}	1	1	Confined
Layer 6	10^{-2}	1	1	Confined

Note: All six layers were set at ten feet thick each.

A containment zone, 100 feet by 100 feet, with an extremely low permeability barrier wall (10^{-8} to 10^{-10} cm/sec) was assumed. While unrealistic, the goal of the modeling was to evaluate a very tight barrier that would exaggerate any potential groundwater elevation increase.

The median hydraulic gradient reported in the HGDB Database (0.006 ft/ft) (Hydrogeologic Database, Newell et al., 1990) was applied to all four top units.

Our goal was to model a typical site where recharge is more of a regional process that results in generally evenly spaced elevation contour lines. When high recharge is modeled on a site specific basis to a low-moderate transmissivity aquifer like the one above, then a non-uniform water table is created: low hydraulic gradient upgradient, then high hydraulic gradient downgradient. This type of pattern is only found in nature where almost all of the flow through a site is from recharge (not from upgradient inflow).

A recharge rate of **2 inches per year** was found to be the maximum recharge rate that could be entered in the model without significant distortion of the groundwater elevation

contour lines. In other words, for the hydraulic conductivities and thicknesses in the table above, two inches of infiltration appeared to be an upper level amount of recharge that maintained a conventional-looking potentiometric surface map with generally evenly spaced contour lines.

With this model run under steady state conditions, the before-barrier (natural conditions) and after-barrier water levels were evaluated at two places in Layer 1: Points A and B. Groundwater elevation increases of only 0.5 feet and 1.1 feet were observed upgradient and inside the barrier, respectively.

Modeling Scenario	Groundwater Elevation at Point A (Upgradient) (feet)	Groundwater Elevation at Point B (Inside Barrier) (feet)
Natural Conditions	54.99	54.42
Flux Barrier	55.45	55.54
Increase in Groundwater Elevation Due to Flux Barrier	0.46	1.12

The model was also used to evaluate a **leaky upgradient wall** as described in the IPR comments. For this purpose, the upgradient portion barrier hydraulic conductivities in each layer were reduced by a factor of 100. That is, to 10^{-6} cm/sec, 10^{-8} cm/sec, 10^{-6} cm/sec, 10^{-8} cm/sec, respectively for each layer. For the leaky upgradient wall scenario, groundwater elevation increases of 0.4 feet and 1.1 feet were observed upgradient and inside the barrier, respectively.

Modeling Scenario	Groundwater Elevation at Point A (Upgradient) (feet)	Groundwater Elevation at Point B (Inside) (feet)
Natural Conditions	54.99	54.42
Leaky Flux Barrier	55.44	55.56
Increase in Groundwater Elevation With Leaky Flux Barrier	0.45	1.14

Finally “**upwelling**” as described in the IPR comments was simulated by modeling the system with no wall in layer four (in the case of unexpected hydrogeologic changes). Groundwater elevation increases of 0.5 feet and 0.8 feet were observed upgradient and inside the barrier, respectively, for the upwelling system.

Modeling Scenario	Groundwater Elevation at Point A (Upgradient)	Groundwater Elevation at Point B (Inside)
--------------------------	--	--

	(feet)	(feet)
Natural Conditions	54.99	54.42
Flux Barrier "Upwelling"	55.45	55.23
Increase in Groundwater Elevation Due to Flux Barrier "Upwelling"	0.46	0.81

How does a relatively small increase in groundwater elevation affect vapor intrusion? The current conceptual model of vapor intrusion has contaminants entering structures in two generally pathways: 1) through preferential pathways such as sewers or other structures that intersect the groundwater at some other point away from the structure; and 2) via diffusion from the underlying plume through the vadose zone. For the first pathway, a slightly higher groundwater elevation is likely to have little or no effect on the vapor intrusion. For the second pathway, a diffusion-based model such as the Johnson-Ettinger (J&E) model can be used to estimate the sensitivity of vapor intrusion to the groundwater elevation.

In the J&E model, the mass flux of vapors from the water table to the building is generally inversely proportional to the distance between the bottom of the foundation and the water table. In an uncertainty study of the J&E model, Weaver and Tillman (2005) decreased the groundwater elevation from 29.5 to 22.1 feet (decrease of 7.4 feet or a 25%) and reported an increase in vapor intrusion risk of 34.7%. In general, the percentage increase in vapor intrusion risk predicted by the J&E model would be related to the percent decrease in the distance from foundation to groundwater.

Despite the limited evidence for groundwater elevation increase, we will recommend in the Final Report that any implementation of a flux reduction barrier under a building include groundwater level monitoring to ensure no unexpected problems from flooding and/or vapor intrusion.

Key Points: Groundwater Modeling
<ul style="list-style-type: none"> • Qualitative factors suggested that high groundwater elevations would not result from the construction of a flux reduction barrier at most sites. • MODFLOW modeling of a conservative case with high assumed recharge rate (11.4 inches per year) indicated that any increases in groundwater would be limited to 1.1 feet in the scenario modeled, accounting for location (upgradient mounding and pooling inside the barrier), leaky upgradient barrier, and upwelling below the wall. • Groundwater levels within a flux reduction barrier should be monitored to ensure that no unexpected rise in groundwater elevation occurs during routine operation of the barrier.

Engineered Factors

Two types of engineered factors could be applied to the flux reduction barrier concept to reduce the potential for high groundwater levels that could exacerbate vapor intrusion problems under active buildings.

First, the flux reduction barriers can be constructed with engineered “**spillways**” that would relieve any groundwater mounding within the barrier due to high recharge sites or extreme recharge events (hurricanes), broken water lines, etc. A conceptual picture of the spill way concept is shown below, where the downgradient portion of the barrier is completed at the highest elevation desired by the building and facilities personnel at the site (**Point C** on the graphic below). In this graphic, most of the groundwater leaving the spillway when it is use would be clean water, as any recharge would have a limited ability to mix with deeper contaminants caused by DNAPL. Therefore, the recharge water would not contribute to increased mass discharge from the barrier.

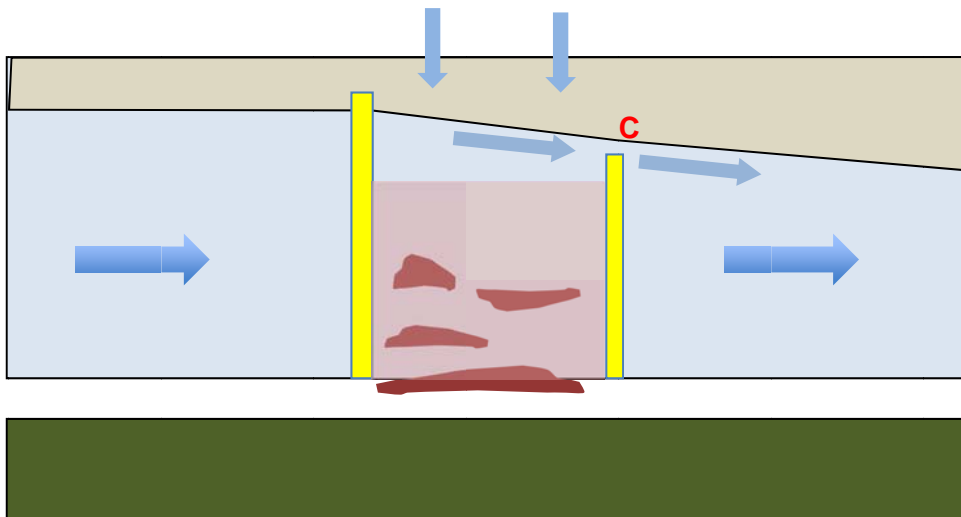

As a second engineered factor, any runoff from the building roof and/or associated parking lots could be **redirected** to areas where this runoff would not be converted to infiltration. Standard stormwater conveyance practices, such as redirecting building downspouts, lining grass swales, and other methods could reduce recharge into the flux reduction barrier. Our Final Report will provide guidelines to potential implementers of this technology and describe how simple calculations and groundwater flow modeling can be used to determine if these improvements should be performed a priori.

In the unusual case where elevated groundwater conditions are observed after construction, these stormwater conveyance practices can be implemented as a mitigation measure to reduce the influx of recharge into the barrier.

Key Points: Engineered Factors

- Stormwater runoff from buildings and associated infrastructure (i.e., parking lots), can be rerouted to reduce any problems from excessive recharge into the flux reduction barrier.
- This could be done before construction of the barrier as a preventive measure, or after, as a relief measure.
- Based on the groundwater flow modeling, we do not expect stormwater rerouting to be needed at most sites. The Final Report will provide guidelines to potential implementers of this technology on how to estimate the risk of elevated groundwater conditions due to a flux reduction barrier.

Two Indirect Factors

Two other considerations regarding the potential for the flux contaminant reduction barriers to cause vapor intrusion problems are reduction in mass flux and the biodegradation of chlorinated solvent daughter products.

Mass Discharge Limitation

McHugh et al. (2003) noted that in some cases, vapor intrusion predicted by models (such as the J&E Model) is greater than the actual mass discharge of contaminants delivered to the area under the building. For cases where a large fraction of the groundwater plume is predicted by the J&E model to serve as a vapor intrusion source, the reduction in mass flux with these barriers would reduce the modeled impact of vapor intrusion and reduce the modeled concentrations in the building. This would likely be relatively rare, as the mass discharge is typically not checked against the J&E model very frequently, and the mass discharge limitation only occurs on a minority of sites.

Contaminants More Aerobically Degradable

Vapor intrusion experts note that aerobically degradable compounds such as benzene, TEX compounds, and vinyl chloride are rarely the focus of vapor intrusion problems because aerobic reactions in the vadose zone are robust and reaction rates are fast. These reactions occur in the narrow band where the contaminant and the oxygen from the surface intersect. One of the anticipated benefits of flux reduction barriers is making source zones more anaerobic, which in turn would mean a higher percentage of the vapors leaving the source zone would likely be aerobically degradable daughter products (e.g., vinyl chloride and potentially cis-1,2-DCE).

These two factors, while potentially reducing the chance that a flux reduction barrier would create increased vapor intrusion problems, are only supporting factors and are not the main processes that will limit vapor intrusion from this technology.

Key Points: Two Indirect Factors
<ul style="list-style-type: none">• Reduction in mass discharge in barriers, and the potential change to more aerobically degradable daughter products, are two indirect factors which may help to reduce the small risk of vapor intrusion from the flux reduction treatment zone to active buildings even more.

REFERENCES

- McHugh, T.E., J.A. Connor, F. Ahmad, and C. J. Newell, 2003. A Groundwater Mass Flux Model For Groundwater-To-Indoor-Air Vapor Intrusion. in: V.S. Magar and M.E. Kelley (Eds.), *In Situ and On-Site Bioremediation—2003*. Proceedings of the Seventh International In Situ and On-Site Bioremediation Symposium (Orlando, FL; June 2003).
- Newell, C. J., L. P. Hopkins, and P. B. Bedient, 1990. "A Hydrogeologic Database for Groundwater Modeling", *Ground Water*, Vol. 28, No. 5.
- Weaver, J. W., and F. D. Tillman, 2005. Uncertainty and the Johnson-Ettinger Model for Vapor Intrusion Calculation, USEPA Document EPA/600/R-05/110, Sept. 2005.
- Wiedemeier, T.H., Rifai, H.S., Newell, C.J., and Wilson, J.W., 1999. Natural Attenuation of Fuels and Chlorinated Solvents, John Wiley & Sons, New York. (equation 2.12)

**SUPPORTING INFORMATION
 EXCERPTS FROM UNCERTAINTY AND THE JOHNSON-ETTINGER MODEL FOR
 VAPOR INTRUSION CALCULATION**

Abstract

The Johnson-Ettinger Model is widely used for assessing the impacts of contaminated vapors on residential air quality. Typical use of this model relies on a suite of estimated data, with few site-specific measurements. Software was developed to provide the public with automated uncertainty analysis applied to the model. (See <http://www.epa.gov/athens/onsite>.) An uncertainty analysis was performed on the model, that accounted for synergistic effects among variable model parameters. This analysis showed that a simple “one-at-a time” parameter uncertainty analysis provides a rough guide for the uncertainty generated by individual parameters and allowed their ranking. The one-at-a-time analysis, however, underestimated the uncertainty in the model results when all or groups of parameters were assumed to be uncertain. An apparent increase in simulated cancer risk caused by the uncertainty introduced from the input parameters was as much as 1285%. The model response to the input parameters showed that for the example studied, there was a positive skew in the model response to parameter variation.

In this uncertainty analysis, USEPA varied depth from building to groundwater (“depth below grade”) from 22.1 ft to 36.0 ft. ($\pm 25\%$)

Table 8 OSWER defaults, ranges and sources of variability for example simulation.

Parameter	Variability Source	Values		
		Low	OSWER default	High
Mixing height [ft]	OSWER range	8	12	16
Floor-wall crack width [mm]	OSWER range	0.5	1	5
Air exchange rate [hr ⁻¹]	OSWER range	0.1	0.25	1.5
Depth below grade [ft]	+/- 25%	22.1	29.5	36.9
Porosity	+/- 25%	0.29	0.387	0.484
Residual moisture content	+/- 25%	0.029	0.039	0.049
Moisture content	OSWER range	0.039	0.103	0.17
Soil gas flow rate [L/min]	OSWER range	1	5	10
Temperature [C]	+/- 25%	11.25	15.0	18.75

The resulting one-at-at-time analysis showed the risk predicted by the model by varying “sample depth” by $\pm 25\%$ (the depth below grade) varied slightly more than $\pm 25\%$: risk uncertainty ranged from - 20.5% to +34.7%.

Table 10 Single Parameters used for One-At-A-Time (OAT) uncertainty assessment of the example problem.

Code	Parameter Groups	Parameters	Change in Risk Given Uncertainty in Results	
			Decreased Risk	Increased Risk
A	Single	Floor-Wall Crack Width	0.0%	0.0%
B	Single	Temperature	0.0%	0.0%
C	Single	Soil Residual Water Content	-7.6%	7.8%
D	Single	Soil Gas Flow Rate	-44.1%	11.0%
E	Single	Porosity	-34.9%	33.1%
F	Single	Sample Depth	-20.5%	34.7%
G	Single	Mixing Height	-25.0%	50.1%
H	Single	Water Content	-53.8%	65.2%
I	Single	Air Exchange Rate	-83.3%	150.0%

APPENDIX E INJECTION SKID DESIGN MANUAL



Operation & Maintenance Manual

NES PROJECT NUMBER: 14-203, June 2015
PROJECT NAME: ESTCP Flux Clog Project Skid & Controls System
G-3938 Indian Head - Maryland

Prepared for:

**GSI Environmental Inc.
2211 Norfolk, Suite 1000
Houston, TX 77098-4054**

**Sales: (508)226-1100 Option 2
Technical Support: (508)226-1100 Option 3**



OPERATION & MAINTENANCE MANUAL

14-203 - GSI 3938- ESTCP FLUX CLOG EQUIPMENT

INDIAN HEAD, MD

SECTION 1 - SUMMARY OF EQUIPMENT

OPERATING INSTRUCTIONS (BY GSI)

COMPONENT SUMMARY

WARRANTY STATEMENT

SECTION 2 - MECHANICAL DRAWINGS & TABLE(S)

PROCESS & INSTRUMENTATION DIAGRAM (P&ID)

T-1, INSTRUMENTATION TABLE

M-2, LAYOUT DRAWING

M-3, EQUIPMENT (T-02) LAYOUT DRAWING

M-4, EQUIPMENT (T-03) LAYOUT DRAWING

SECTION 3 - PROCESS EQUIPMENT & VALVES

TANK, 750 GALLON, HDPE, 1.9 SG - CUSTOM ROTO MOLD 750VTSXLPE

DRUM STANDS - HARPER 8814-41

TRANSFER PUMP, 0.75 HP - GOULDS 1ST1D5D4

TRANSFER PUMP MOTOR, 0.75, 208 VAC - BLUFFTON 1313460103

INJECTION PUMP, 1.5 HP - GOULDS 1ST1F5B4

1 INCH STATIC MIXER, 6-BLADE, PVC (1 SPARE) - KO-FLO 1-40C-4-6-2

TRANSFER PUMP BALL VALVE, 1.5" PVC - SPEARS SPL3629-015 (1-1/2 INCH)

TRANSFER PUMP BALL VALVE, 1" PVC - SPEARS SPL3629-010 (1 INCH)

TRANSFER PUMP CHECK VALVE, 1" BRASS - LEGEND LEG105-105



TRANSFER PUMP THROTTLING GATE VALVE, 1" BRASS - LEGEND LEG104-465

INJECTION MANIFOLD PINCH VALVE, 0.5 OD TUBE - PBM PVHLC1MV-05

SECTION 4 - PROCESS INSTRUMENTATION

FLOW TOTALIZER, 0.5 INCH – OMEGA FTB-4105A

FLOW METER, 1 INCH - DWYER VFC-143-EC

FLOW TOTALIZER, 0.75 INCH - OMEGA FTB-4107A

FLOW TOTALIZER, 1 INCH - OMEGA FTB-4110A

PRESSURE INDICATOR, 0 - 60 PSI (6 SPARE) - DWYER SGY-10422N-GF

PRESSURE SWITCH, 4 - 75 PSI - DWYER A1F-PC-SS-1-2

PRESSURE INDICATOR, 0 - 60 PSI - DWYER SGY-10422N-GF

SECTION 5 - ELECTRICAL DRAWINGS & TABLE(S)

T-2, INTERLOCK TABLE

I-1, CONTROL PANEL LAYOUT DRAWING

T-3, ELECTRICAL PANEL BOM

I-2, WIRING DIAGRAMS & TERMINAL DETAILS

E-1, LINE DIAGRAM

SECTION 6 - CONTROL COMPONENTS

NEMA 4 ENCLOSURE 36 X 36 X 12 MILD STEEL/WHT - HAMMOND EN4SD20X20X8GY

MUSHROOM SWITCH RED TRIGGER ACTION - TURN TO RELEASE - SQUARE D ZB5AS844



SECTION 1 - SUMMARY OF EQUIPMENT

OPERATING INSTRUCTIONS (BY GSI)

COMPONENT SUMMARY

WARRANTY STATEMENT

NES MAJOR COMPONENT SUMMARY

REVISION A

JUNE 2015

PROJECT NO.:

14-203

GSI 3938- ESTCP FLUX CLOG EQUIPMENT - INDIAN HEAD, MD

COMPONENT	TAG	QTY	MANUFACTURER	MODEL	SERIAL NUMBER
SECTION 1 - SUMMARY OF EQUIPMENT					
OPERATING INSTRUCTIONS (BY GSI)					
COMPONENT SUMMARY					
WARRANTY STATEMENT					
SECTION 2 - MECHANICAL DRAWINGS & TABLE(S)					
M-1, PROCESS & INSTRUMENTATION DIAGRAM (P&ID)	M-1				
T-1, INSTRUMENTATION TABLE	T-1				
M-2, LAYOUT DRAWING	M-2				
M-3, EQUIPMENT (T-02) LAYOUT DRAWING	M-3				
M-4, EQUIPMENT (T-03) LAYOUT DRAWING	M-4				
SECTION 3 - PROCESS EQUIPMENT & VALVES					
TANK, 750 GALLON, HDPE, 1.9 SG	T-02 & T-03	2	CUSTOM ROTO MOLD	750VTSXLPE	N/A
DRUM STANDS	T-04 & T-05	2	HARPER	8814-41	N/A
TRANSFER PUMP, 0.75 HP	P-01	1	GOULDS	1ST1D504	E1504863
TRANSFER PUMP MOTOR, 0.75, 208 VAC	P-01	1	BLUFFTON	1313460103	1503100377
INJECTION PUMP, 1.5 HP	P-02 & P-03	2	GOULDS	1ST1F584	E1503712
INJECTION PUMP MOTOR, 1.5 HP, 208 VAC	P-02 & P-03	2	BLUFFTON	1313480103	1504021757 / 1504021827
1 INCH STATIC MIXER, 6-BLADE, PVC (1 SPARE)	SM-01	1	KO-FLO	1-40C-4-6-2	N/A
TRANSFER PUMP BALL VALVE, 1.5" PVC		3	SPEARS	SPL3629-015 (1-1/2 INCH)	N/A
TRANSFER PUMP BALL VALVE, 1" PVC		12	SPEARS	SPL3629-010 (1 INCH)	N/A
TRANSFER PUMP CHECK VALVE, 1" BRASS		3	LEGEND	LEG105-105	N/A
TRANSFER PUMP THROTTLING GATE VALVE, 1" BRASS		3	LEGEND	LEG104-465	N/A
INJECTION MANIFOLD PINCH VALVE, 0.5 OD TUBE		12	PBM	PVHLC1MV-05	N/A
SECTION 4 - PROCESS INSTRUMENTATION					
FLOW TOTALIZER, 0.5 INCH	FT-102/105 & FT-201/212	15	OMEGA	FTB-4105A	41000121 / 41901812 // 41001172 / 41901806 / 41000116 / 41000115 / 41000195 / 41000125 / 41901807 / 41000194 / 41000113 / 41000120 / 41901898 / 41901897 / 41000112
FLOW METER, 1 INCH	FM-101 & FM-102	2	DWYER	VFC-143-EC	N/A
FLOW TOTALIZER, 0.75 INCH	FT-104 & FT-106	2	OMEGA	FTB-4107A	44102644 / 4100641
FLOW TOTALIZER, 1 INCH	FT-101	1	OMEGA	FTB-4110A	5675220044
PRESSURE INDICATOR, 0 - 60 PSI (6 SPARE)	PI-101 / 104	4	DWYER	SGY-10422N-GF	N/A
PRESSURE SWITCH, 4 - 75 PSI	PSH-101	1	DWYER	A1F-PC-SS-1-2	N/A
PRESSURE INDICATOR, 0 - 60 PSI	PI-201 / 212	12	DWYER	SGY-10422N-GF	N/A
SECTION 5 - ELECTRICAL DRAWINGS & TABLE(S)					
T-2, INTERLOCK TABLE	T-2				
I-1, CONTROL PANEL LAYOUT DRAWING	I-1				
T-3, ELECTRICAL PANEL BOM	T-2				
I-2, WIRING DIAGRAMS & TERMINAL DETAILS	I-2				
E-1, LINE DIAGRAM	E-1				
SECTION 6 - CONTROL COMPONENTS					
NEMA 4 ENCLOSURE 36 X 36 X 12 MILD STEEL/WHT	ENCL	1	HAMMOND	EN4SD20X20X8GY	UL: A11975140
BACK-PANEL - FITS ENCL. 36 X 36 - MILD STEEL/WHT	ENCL	1	HAMMOND	EP2020	N/A
MOUNTING FEET SET OF 4 - ZINC PLATED	ENCL	1	HAMMOND	EZPMFHD	N/A
PANEL WING-KNOB PAD-LOCKING HANDLE BLACK	ENCL	2	SCE	SCE-PLWKB	N/A
RELAY 2PDT 10AMP 120VAC W/INDICATOR LIGHT	CR	2	IDEC	RH2B-UL-AC 120V	N/A
SOCKET DIN RAIL/SURFACE 8-BLADE FOR RH2B	CR	2	IDEC	SH2B-05	N/A
CIRCUIT BREAKER 6A 1-POLE 120/240 VAC 1-PHASE 10KA DIN-MOUNT	CB	1	SQUARE D	MG24430	N/A
PUSH BUTTON OPERATOR NON-ILLUM BLACK	PB	1	SQUARE D	ZB5AA 2	N/A
2 POSITION SELECTOR SWITCH ILLUM. GREEN MAINTAINED	SW	1	SQUARE D	ZB5AK1233	N/A

NES MAJOR COMPONENT SUMMARY

REVISION A

JUNE 2015

PROJECT NO.:

14-203

GSI 3938- ESTCP FLUX CLOG EQUIPMENT - INDIAN HEAD, MD

COMPONENT	TAG	QTY	MANUFACTURER	MODEL	SERIAL NUMBER
MUSHROOM SWITCH NON-ILLUM RED TRIGGER ACTION - TURN TO RELEASE	ESTOP	1	SQUARE D	ZB5AS844	N/A
CONTACT BLOCK 1-N.C. SCREW CLAMP	PB	1	SQUARE D	ZBE102	N/A
MOUNTING BASE 120V GREEN PROTECTED LED	SW	4	SQUARE D	ZB5AVG3	N/A
POWER DISTRIBUTION BLOCK 175 AMP 3-POLE 600V	DB	1	SQUARE D	9080-LBA362104	N/A
DISTRIBUTION BLOCK PLASTIC COVER 3-POLE	DB	1	SQUARE D	9080-LB23	N/A
PK12GTA LOAD CENTER GROUND BAR 12 TERMINALS	GB	1	SQUARE D	PK15GTA	N/A
PILOT LIGHT HEAD RED	LT	2	SQUARE D	ZB5AV043	N/A
MOUNTING BASE 120V RED PROTECTED LED	SW	2	SQUARE D	ZB5AVG4	N/A
MOUNTING COLLAR LATCH	PB	2	SQUARE D	ZB5AZ009	N/A
CONTACT BLOCK 1-N.O. SCREW CLAMP	PB	3	SQUARE D	ZBE101	N/A
TERMINAL BLOCK END BARRIERS GRAY	TB	7	SQUARE D	NSYTRAC22	N/A
TERMINAL BLOCK END ANCHORS	TB	6	SQUARE D	NSYTRAABV35	N/A
TERMINAL BLOCK SCREW CLAMP 20 AMP 600 V GRAY	TB	25	SQUARE D	NSYTRV22	N/A
TERMINAL BLOCK SCREW CLAMP 20 AMP 600 V BLUE	TB	25	SQUARE D	NSYTRV22BL	N/A



WARRANTY

All products not manufactured by RapidTech LLC d/b/a National Environmental Systems, carry the original manufacturer's warranty. Copies are available on request.

RapidTech LLC d/b/a National Environmental Systems, warrants its packaged and manufactured equipment against any defect in material or workmanship, under normal use and storage for a period of twelve (12) months from date of manufacture and invoice, regardless of system start-up date. In the event that products are found to be defective within the warranty period, RapidTech LLC d/b/a National Environmental Systems, sole obligation and remedy shall be the furnishing of replacements for any defective parts, and such replacement parts shall be furnished but not installed by RapidTech LLC d/b/a National Environmental Systems. RAPIDTECH LLC D/B/A NATIONAL ENVIRONMENTAL SYSTEMS, WILL NOT BE LIABLE FOR SPECIAL OR CONSEQUENTIAL DAMAGES IN ANY CLAIM SUIT OR PROCEEDINGS ARISING UNDER WARRANTY, NOR WILL RAPIDTECH LLC D/B/A NATIONAL ENVIRONMENTAL SYSTEMS, ACCEPT ANY LIABILITY FOR CLAIMS FOR LABOR, LOSS OR PROFIT, REPAIRS OR OTHER EXPENSES INCIDENTAL TO REPLACEMENT.

The warranty requires that the purchaser complete all operations and maintenance as detailed in each section of the Operation & Maintenance Manual supplied with the purchased system. In addition installation must comply with nationally recognized electrical and mechanical standards as well as best engineering practices in effect at the time of purchase.

The product warranty expressed above is our only warranty and may not be verbally changed or modified by any representative of RapidTech LLC d/b/a National Environmental Systems. All freight costs incurred in shipping parts to or from RapidTech LLC d/b/a National Environmental Systems, or to the manufacturer if necessary are at the expense of the customer.

RapidTech LLC dba National Environmental Systems, will invoice the cost of any replacement parts. These parts will be credited upon certification the original part was defective and the defective part was returned within one week of notifying RapidTech LLC d/b/a National Environmental Systems, of the malfunction. If the part is found to have been misused no credit will be issued. In order for RapidTech LLC d/b/a National Environmental Systems, to ship a replacement part on account, all outstanding invoices must be current.

RapidTech LLC d/b/a National Environmental Systems, expressly disclaims any warranties, expressed or implied, including any warranty of merchantability or fit for particular purpose or any warranty arising from a course of dealing or usage of trade. Except to the extent required by applicable law. RapidTech LLC d/b/a National Environmental Systems, shall not be liable, in tort, contract or otherwise, for any loss or damage, whether direct, consequential or incidental, of any person or entity arising in connections with the equipment.



SECTION 2 - MECHANICAL DRAWINGS & TABLE(S)

PROCESS & INSTRUMENTATION DIAGRAM (P&ID)

T-1, INSTRUMENTATION TABLE

M-2, LAYOUT DRAWING

M-3, EQUIPMENT (T-02) LAYOUT DRAWING

M-4, EQUIPMENT (T-03) LAYOUT DRAWING

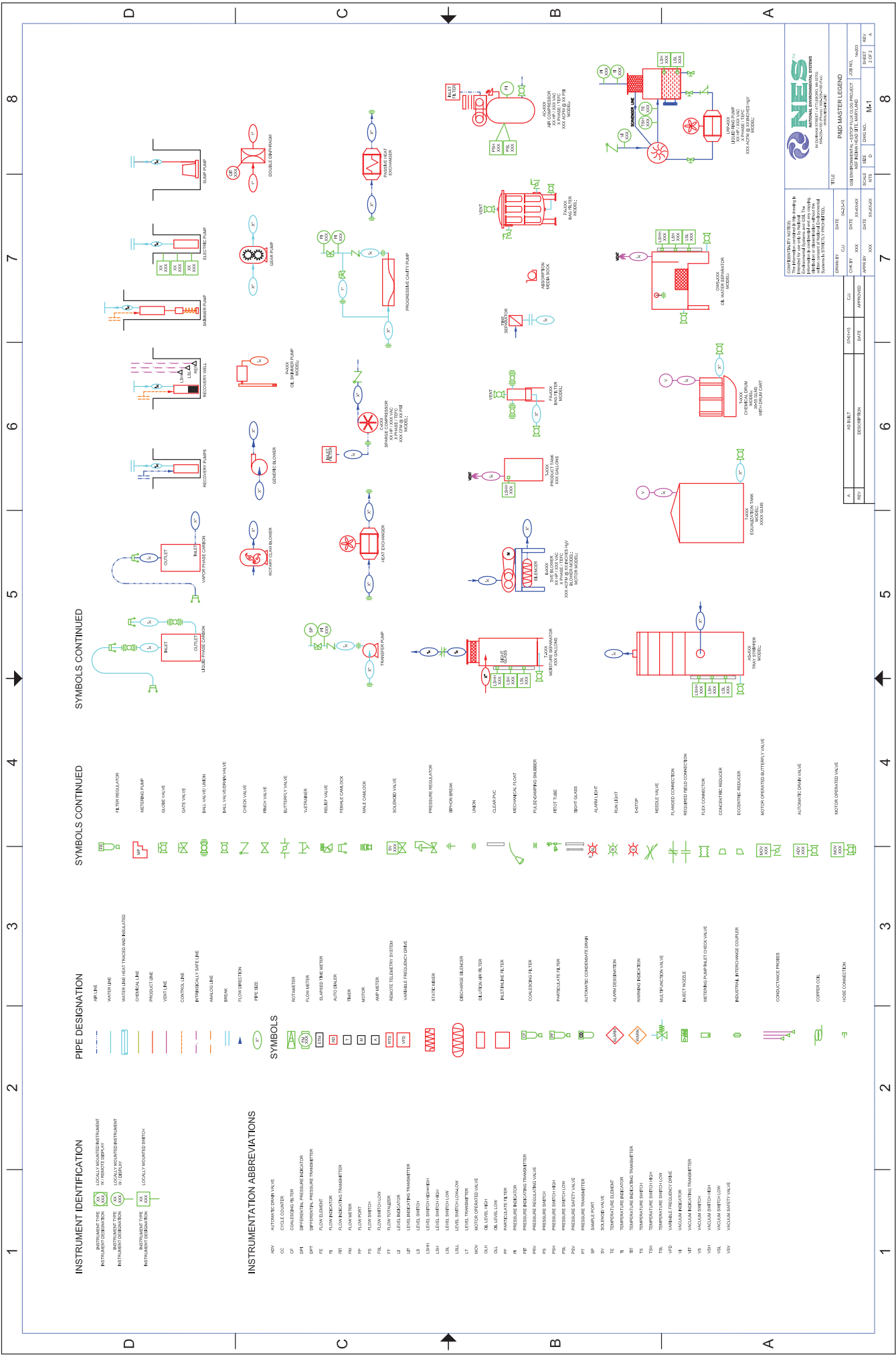

INSTRUMENT IDENTIFICATION

	LOCALLY MOUNTED INSTRUMENT
	LOCALLY MOUNTED INSTRUMENT IN DISPLAY
	LOCALLY MOUNTED SWITCH

PIPE DESIGNATION

	AIR LINE
	WATER LINE
	WATER LINE HEAT TRACED AND INSULATED
	CHEMICAL LINE
	PRODUCT LINE
	VENT LINE
	CONTROL LINE
	INTRINSICALLY SAFE LINE
	ANALOG LINE

SYMBOLS CONTINUED

	FILTER REGULATOR
	METERING PUMP
	GLOBE VALVE
	GATE VALVE
	BALL VALVE (UNPILOT)
	BALL VALVE (PILOT)
	CHECK VALVE
	PLUG VALVE
	BUTTERFLY VALVE
	V-TRAINER
	RELIEF VALVE
	FEMALE CONNECTOR
	MALE CONNECTOR
	SOLENOID VALVE
	PRESSURE REGULATOR
	SWITCH BLOCK
	UNIN
	CLEAN PVC
	MECHANICAL FLOAT
	PULSE COUNTING CHAMBER
	PITOT TUBE
	SIGHT GLASS
	ALARM LIGHT
	RAIN LIGHT
	E-STOP
	NEEDLE VALVE
	FLANGED CONNECTION
	RESIZED FLANGE CONNECTION
	FLARE CONNECTION
	CONCENTRIC REDUCER
	ECCENTRIC REDUCER
	MOTOR OPERATED BUTTERFLY VALVE

SYMBOLS CONTINUED

	AIR LINE
	WATER LINE
	WATER LINE HEAT TRACED AND INSULATED
	CHEMICAL LINE
	PRODUCT LINE
	VENT LINE
	CONTROL LINE
	INTRINSICALLY SAFE LINE
	ANALOG LINE

SYMBOLS CONTINUED

	ROTAMETER
	FLOW METER
	BLURRED FLOW METER
	AUTO SHUTOFF
	THERM
	MOTOR
	AMP METER
	REMOTE TELEMETRY SYSTEM
	VARIABLE FREQUENCY DRIVE

SYMBOLS CONTINUED

	STATIC METER
	DISCHARGE SENSOR
	CLEAN AIR FILTER
	AIR FILTER
	MECHANICAL FLOAT
	PULSE COUNTING CHAMBER
	PITOT TUBE
	SIGHT GLASS
	ALARM LIGHT
	RAIN LIGHT
	E-STOP
	NEEDLE VALVE
	FLANGED CONNECTION
	RESIZED FLANGE CONNECTION
	FLARE CONNECTION
	CONCENTRIC REDUCER
	ECCENTRIC REDUCER
	MOTOR OPERATED BUTTERFLY VALVE

SYMBOLS CONTINUED

	FILTER REGULATOR
	METERING PUMP
	GLOBE VALVE
	GATE VALVE
	BALL VALVE (UNPILOT)
	BALL VALVE (PILOT)
	CHECK VALVE
	PLUG VALVE
	BUTTERFLY VALVE
	V-TRAINER
	RELIEF VALVE
	FEMALE CONNECTOR
	MALE CONNECTOR
	SOLENOID VALVE
	PRESSURE REGULATOR
	SWITCH BLOCK
	UNIN
	CLEAN PVC
	MECHANICAL FLOAT
	PULSE COUNTING CHAMBER
	PITOT TUBE
	SIGHT GLASS
	ALARM LIGHT
	RAIN LIGHT
	E-STOP
	NEEDLE VALVE
	FLANGED CONNECTION
	RESIZED FLANGE CONNECTION
	FLARE CONNECTION
	CONCENTRIC REDUCER
	ECCENTRIC REDUCER
	MOTOR OPERATED BUTTERFLY VALVE

INSTRUMENTATION ABBREVIATIONS

ADV	AUTOMATIC CONTROL VALVE
CC	CYCLE COUNTER
CF	CONDENSING FILTER
DI	DIFFERENTIAL PRESSURE INDICATOR
DPT	DIFFERENTIAL PRESSURE TRANSMITTER
FE	FLOW ELEMENT
FI	FLOW INDICATOR
FM	FLOW METER
FP	FLOW POINT
FS	FLOW SWITCH
FL	FLOW SWITCH/LOW
FT	FLOW TRANSDUCER
LI	LEVEL INDICATOR
LT	LEVEL TRANSMITTER
LS	LEVEL SWITCH
LSH	LEVEL SWITCH/HIGH
LSL	LEVEL SWITCH/LOW
LSL	LEVEL SWITCH/LOW
LT	LEVEL TRANSMITTER
LV	LEVEL VALVE
OV	OVERFLOW
OLL	OVERFLOW
PF	PARTICULATE FILTER
PI	PRESSURE INDICATOR
PT	PRESSURE TRANSMITTER
PS	PRESSURE SWITCH
PSH	PRESSURE SWITCH/HIGH
PSL	PRESSURE SWITCH/LOW
PSV	PRESSURE SAFETY VALVE
PT	PRESSURE TRANSMITTER
SP	SAMPLE POINT
SV	SOLENOID VALVE
TE	TEMPERATURE ELEMENT
TI	TEMPERATURE INDICATOR
TT	TEMPERATURE TRANSMITTER
TR	TEMPERATURE RANGE
TRH	TEMPERATURE SWITCH/HIGH
TRL	TEMPERATURE SWITCH/LOW
VFI	VARIABLE FREQUENCY DRIVE
VI	VACUUM INDICATOR
VT	VACUUM TRANSMITTER
VS	VACUUM SWITCH
VSH	VACUUM SWITCH/HIGH
VSL	VACUUM SWITCH/LOW
VSV	VACUUM SAFETY VALVE

SYMBOLS

	ROTAMETER
	FLOW METER
	BLURRED FLOW METER
	AUTO SHUTOFF
	THERM
	MOTOR
	AMP METER
	REMOTE TELEMETRY SYSTEM
	VARIABLE FREQUENCY DRIVE

SYMBOLS CONTINUED

	STATIC METER
	DISCHARGE SENSOR
	CLEAN AIR FILTER
	AIR FILTER
	MECHANICAL FLOAT
	PULSE COUNTING CHAMBER
	PITOT TUBE
	SIGHT GLASS
	ALARM LIGHT
	RAIN LIGHT
	E-STOP
	NEEDLE VALVE
	FLANGED CONNECTION
	RESIZED FLANGE CONNECTION
	FLARE CONNECTION
	CONCENTRIC REDUCER
	ECCENTRIC REDUCER
	MOTOR OPERATED BUTTERFLY VALVE

SYMBOLS CONTINUED

	FILTER REGULATOR
	METERING PUMP
	GLOBE VALVE
	GATE VALVE
	BALL VALVE (UNPILOT)
	BALL VALVE (PILOT)
	CHECK VALVE
	PLUG VALVE
	BUTTERFLY VALVE
	V-TRAINER
	RELIEF VALVE
	FEMALE CONNECTOR
	MALE CONNECTOR
	SOLENOID VALVE
	PRESSURE REGULATOR
	SWITCH BLOCK
	UNIN
	CLEAN PVC
	MECHANICAL FLOAT
	PULSE COUNTING CHAMBER
	PITOT TUBE
	SIGHT GLASS
	ALARM LIGHT
	RAIN LIGHT
	E-STOP
	NEEDLE VALVE
	FLANGED CONNECTION
	RESIZED FLANGE CONNECTION
	FLARE CONNECTION
	CONCENTRIC REDUCER
	ECCENTRIC REDUCER
	MOTOR OPERATED BUTTERFLY VALVE

SYMBOLS CONTINUED

	FILTER REGULATOR
	METERING PUMP
	GLOBE VALVE
	GATE VALVE
	BALL VALVE (UNPILOT)
	BALL VALVE (PILOT)
	CHECK VALVE
	PLUG VALVE
	BUTTERFLY VALVE
	V-TRAINER
	RELIEF VALVE
	FEMALE CONNECTOR
	MALE CONNECTOR
	SOLENOID VALVE
	PRESSURE REGULATOR
	SWITCH BLOCK
	UNIN
	CLEAN PVC
	MECHANICAL FLOAT
	PULSE COUNTING CHAMBER
	PITOT TUBE
	SIGHT GLASS
	ALARM LIGHT
	RAIN LIGHT
	E-STOP
	NEEDLE VALVE
	FLANGED CONNECTION
	RESIZED FLANGE CONNECTION
	FLARE CONNECTION
	CONCENTRIC REDUCER
	ECCENTRIC REDUCER
	MOTOR OPERATED BUTTERFLY VALVE

SYMBOLS CONTINUED

	FILTER REGULATOR
	METERING PUMP
	GLOBE VALVE
	GATE VALVE
	BALL VALVE (UNPILOT)
	BALL VALVE (PILOT)
	CHECK VALVE
	PLUG VALVE
	BUTTERFLY VALVE
	V-TRAINER
	RELIEF VALVE
	FEMALE CONNECTOR
	MALE CONNECTOR
	SOLENOID VALVE
	PRESSURE REGULATOR
	SWITCH BLOCK
	UNIN
	CLEAN PVC
	MECHANICAL FLOAT
	PULSE COUNTING CHAMBER
	PITOT TUBE
	SIGHT GLASS
	ALARM LIGHT
	RAIN LIGHT
	E-STOP
	NEEDLE VALVE
	FLANGED CONNECTION
	RESIZED FLANGE CONNECTION
	FLARE CONNECTION
	CONCENTRIC REDUCER
	ECCENTRIC REDUCER
	MOTOR OPERATED BUTTERFLY VALVE

SYMBOLS CONTINUED

	FILTER REGULATOR
	METERING PUMP
	GLOBE VALVE
	GATE VALVE
	BALL VALVE (UNPILOT)
	BALL VALVE (PILOT)
	CHECK VALVE
	PLUG VALVE
	BUTTERFLY VALVE
	V-TRAINER
	RELIEF VALVE
	FEMALE CONNECTOR
	MALE CONNECTOR
	SOLENOID VALVE
	PRESSURE REGULATOR
	SWITCH BLOCK
	UNIN
	CLEAN PVC
	MECHANICAL FLOAT
	PULSE COUNTING CHAMBER
	PITOT TUBE
	SIGHT GLASS
	ALARM LIGHT
	RAIN LIGHT
	E-STOP
	NEEDLE VALVE
	FLANGED CONNECTION
	RESIZED FLANGE CONNECTION
	FLARE CONNECTION
	CONCENTRIC REDUCER
	ECCENTRIC REDUCER
	MOTOR OPERATED BUTTERFLY VALVE

INSTRUMENTATION ABBREVIATIONS

ADV	AUTOMATIC CONTROL VALVE
CC	CYCLE COUNTER
CF	CONDENSING FILTER
DI	DIFFERENTIAL PRESSURE INDICATOR
DPT	DIFFERENTIAL PRESSURE TRANSMITTER
FE	FLOW ELEMENT
FI	FLOW INDICATOR
FM	FLOW METER
FP	FLOW POINT
FS	FLOW SWITCH
FL	FLOW SWITCH/LOW
FT	FLOW TRANSDUCER
LI	LEVEL INDICATOR
LT	LEVEL TRANSMITTER
LS	LEVEL SWITCH
LSH	LEVEL SWITCH/HIGH
LSL	LEVEL SWITCH/LOW
LSL	LEVEL SWITCH/LOW
LT	LEVEL TRANSMITTER
LV	LEVEL VALVE
OV	OVERFLOW
OLL	OVERFLOW
PF	PARTICULATE FILTER
PI	PRESSURE INDICATOR
PT	PRESSURE TRANSMITTER
PS	PRESSURE SWITCH
PSH	PRESSURE SWITCH/HIGH
PSL	PRESSURE SWITCH/LOW
PSV	PRESSURE SAFETY VALVE
PT	PRESSURE TRANSMITTER
SP	SAMPLE POINT
SV	SOLENOID VALVE
TE	TEMPERATURE ELEMENT
TI	TEMPERATURE INDICATOR
TT	TEMPERATURE TRANSMITTER
TR	TEMPERATURE RANGE
TRH	TEMPERATURE SWITCH/HIGH
TRL	TEMPERATURE SWITCH/LOW
VFI	VARIABLE FREQUENCY DRIVE
VI	VACUUM INDICATOR
VT	VACUUM TRANSMITTER
VS	VACUUM SWITCH
VSH	VACUUM SWITCH/HIGH
VSL	VACUUM SWITCH/LOW
VSV	VACUUM SAFETY VALVE

SYMBOLS

	ROTAMETER
	FLOW METER
	BLURRED FLOW METER
	AUTO SHUTOFF
	THERM
	MOTOR
	AMP METER
	REMOTE TELEMETRY SYSTEM
	VARIABLE FREQUENCY DRIVE

SYMBOLS CONTINUED

	STATIC METER
	DISCHARGE SENSOR
	CLEAN AIR FILTER
	AIR FILTER
	MECHANICAL FLOAT
	PULSE COUNTING CHAMBER
	PITOT TUBE
	SIGHT GLASS
	ALARM LIGHT
	RAIN LIGHT
	E-STOP
	NEEDLE VALVE
	FLANGED CONNECTION
	RESIZED FLANGE CONNECTION
	FLARE CONNECTION
	CONCENTRIC REDUCER
	ECCENTRIC REDUCER
	MOTOR OPERATED BUTTERFLY VALVE

SYMBOLS CONTINUED

	FILTER REGULATOR
	METERING PUMP
	GLOBE VALVE
	GATE VALVE
	BALL VALVE (UNPILOT)
	BALL VALVE (PILOT)
	CHECK VALVE
	PLUG VALVE
	BUTTERFLY VALVE
	V-TRAINER
	RELIEF VALVE
	FEMALE CONNECTOR
	MALE CONNECTOR
	SOLENOID VALVE
	PRESSURE REGULATOR
	SWITCH BLOCK
	UNIN
	CLEAN PVC
	MECHANICAL FLOAT
	PULSE COUNTING CHAMBER
	PITOT TUBE
	SIGHT GLASS
	ALARM LIGHT
	RAIN LIGHT
	E-STOP
	NEEDLE VALVE
	FLANGED CONNECTION
	RESIZED FLANGE CONNECTION
	FLARE CONNECTION
	CONCENTRIC REDUCER
	ECCENTRIC REDUCER
	MOTOR OPERATED BUTTERFLY VALVE

SYMBOLS CONTINUED

	FILTER REGULATOR
	METERING PUMP
	GLOBE VALVE

TABLE 1
PROCESS INSTRUMENTATION DIAGRAM INSTRUMENT LIST

REVISION A
14-203
JUNE 2015
GSI 3938- ESTCP FLUX CLOG EQUIPMENT - INDIAN HEAD, MD

TAG	ITEM	MODEL	MANUFACTURER	SPECIFICATION
FT-102/105 & FT-201/212	FLOW TOTALIZER, 0.5 INCH	FTB-4105A	OMEGA	0.13-13 GPM TURBINE METER LOCAL DISPLAY / WETTED PARTS BRASS, SS, POLYIMIDE, POLYPRO / EPDM O-RING / 0.5 IN MNPT / MAX TEMP 200F / MAX PRESS 150PSI
FM-101 & FM-102	FLOW METER, 1 INCH	VFC-143-EC	DWYER	DWYER / FLOWMETER 2-20 GPM / ACRYLIC BODY / Buna- N O-RING / SS FLOAT / 1 IN FNPT BOTTOM PROCESS / MAX TEMP 120 F / MAX PRESSURE 100 PSI
FT-104 & FT-106	FLOW TOTALIZER, 0.75 INCH	FTB-4107A	OMEGA	OMEGA / 0.22-20 GPM TURBINE METER LOCAL DISPLAY / WETTED PARTS BRASS, SS, POLYIMIDE, POLYPRO / EPDM O-RING / 0.75 IN MNPT / MAX TEMP 200F / MAX PRESS 150PSI
FT-101	FLOW TOTALIZER, 1 INCH	FTB-4110A	OMEGA	OMEGA / 0.5-50 GPM TURBINE METER LOCAL DISPLAY / WETTED PARTS BRASS, SS, POLYIMIDE, POLYPRO / EPDM O-RING / 1 IN MNPT / MAX TEMP 200F / MAX PRESS 150PSI
PI-101 / 104	PRESSURE INDICATOR, 0 - 60 PSI (6 SPARE)	SGY-10422N-GF	DWYER	0 - 60 PSIG RANGE / LIQUID FILLED / 2.5 INCH SS CASE / SS WETTED PARTS / 0.25 INCH BOTTOM CONNECTION / -40 F TO 140 F TEMP LIMITS
PSH-101	PRESSURE SWITCH, 4 - 75 PSI	A1F-PC-SS-1-2	DWYER	4 - 75 PSIG RANGE / POLYCARBONATE CASE / SS WETTED PARTS / 0.25 INCH BOTTOM CONNECTION / -40 F TO 175 F TEMP LIMITS / NEMA 4X RATING
PI-201 / 212	PRESSURE INDICATOR, 0 - 60 PSI	SGY-10422N-GF	DWYER	0 - 60 PSIG RANGE / LIQUID FILLED / 2.5 INCH SS CASE / SS WETTED PARTS / 0.25 INCH BOTTOM CONNECTION / -40 F TO 140 F TEMP LIMITS

4

3

2

1

D

C

B

A

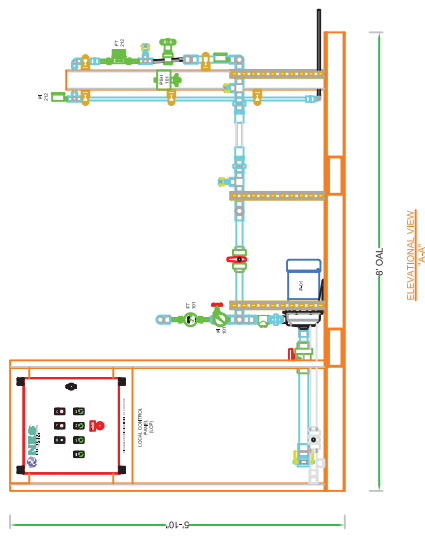
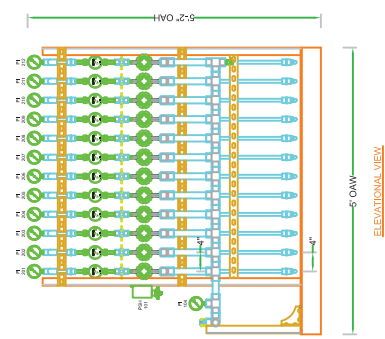
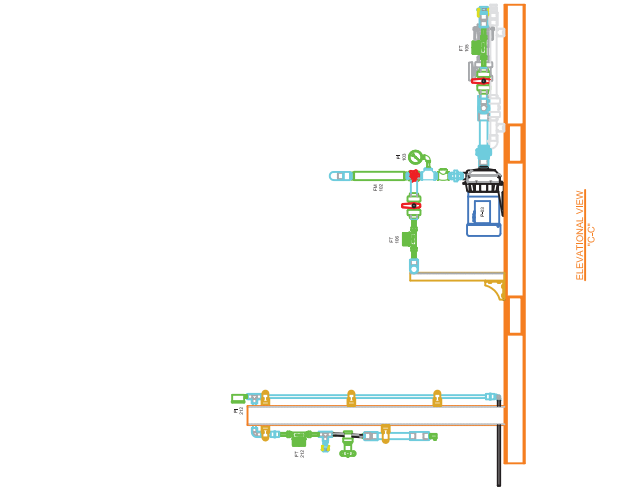
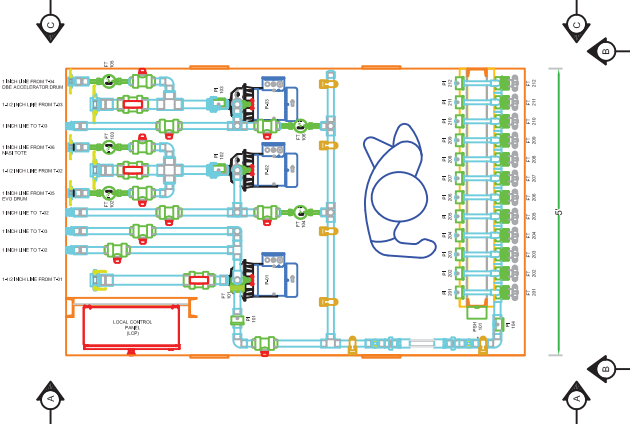

CONFIDENTIALITY NOTICE: This drawing is intended for use only by National Environmental Systems and CSI. The information is confidential and any copying, without the written consent of National Environmental Systems is STRICTLY PROHIBITED.		DATE	04-28-15
DRWN BY	CJJ	DATE	07-01-15
CHK BY	CJJ	DATE	07-01-15
APPR BY		DATE	

AS BUILT	DESCRIPTION	DATE	APPROVED
REV			

SYSTEM LAYOUT		SCALE	20	SIZE	C	DWG NO.	M-2	SHEET	1 OF 1	REV	A
GSI ENVIRONMENTAL - ESTOP FLUX CLOG PROJECT		JOB NO.		14,203		NSF INDIAN SITE - MARYLAND		M-2		REV	

4

3

2

1

D

C

B

A

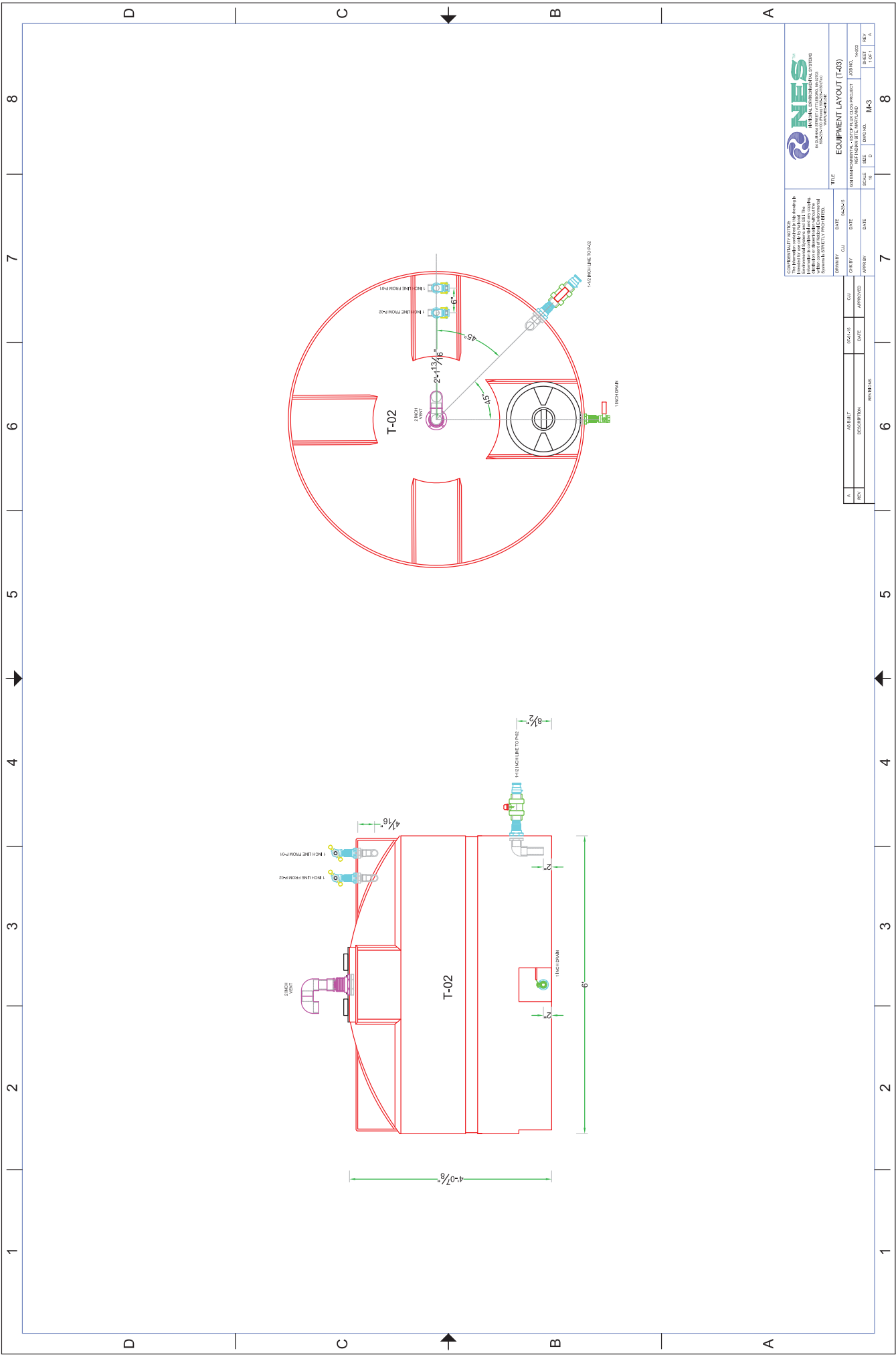

COMPLETENESS NOTICE:
 This drawing is intended to provide information for the construction of the project. It is not intended to be used for any other purpose. The user of this drawing is responsible for verifying the accuracy of the information provided and for obtaining all necessary permits and approvals. The user of this drawing is also responsible for ensuring that the information provided is consistent with the applicable laws and regulations. NES is not responsible for any errors or omissions in this drawing.

CONTRACTOR'S NOTICE:
 This drawing is intended to provide information for the construction of the project. It is not intended to be used for any other purpose. The user of this drawing is responsible for verifying the accuracy of the information provided and for obtaining all necessary permits and approvals. The user of this drawing is also responsible for ensuring that the information provided is consistent with the applicable laws and regulations. NES is not responsible for any errors or omissions in this drawing.

DESIGNER'S NOTICE:
 This drawing is intended to provide information for the construction of the project. It is not intended to be used for any other purpose. The user of this drawing is responsible for verifying the accuracy of the information provided and for obtaining all necessary permits and approvals. The user of this drawing is also responsible for ensuring that the information provided is consistent with the applicable laws and regulations. NES is not responsible for any errors or omissions in this drawing.

DATE: 06/20/2023
DATE: 06/20/2023
DATE: 06/20/2023

DATE: 06/20/2023
DATE: 06/20/2023
DATE: 06/20/2023

DATE: 06/20/2023
DATE: 06/20/2023
DATE: 06/20/2023

DATE: 06/20/2023
DATE: 06/20/2023
DATE: 06/20/2023

DATE: 06/20/2023
DATE: 06/20/2023
DATE: 06/20/2023

DATE: 06/20/2023
DATE: 06/20/2023
DATE: 06/20/2023

DATE: 06/20/2023
DATE: 06/20/2023
DATE: 06/20/2023

DATE: 06/20/2023
DATE: 06/20/2023
DATE: 06/20/2023

DATE: 06/20/2023
DATE: 06/20/2023
DATE: 06/20/2023

TITLE: EQUIPMENT LAYOUT (T-03)
DATE: 06/20/2023
DATE: 06/20/2023
DATE: 06/20/2023

DATE: 06/20/2023
DATE: 06/20/2023
DATE: 06/20/2023

DATE: 06/20/2023
DATE: 06/20/2023
DATE: 06/20/2023

DATE: 06/20/2023
DATE: 06/20/2023
DATE: 06/20/2023

DATE: 06/20/2023
DATE: 06/20/2023
DATE: 06/20/2023

DATE: 06/20/2023
DATE: 06/20/2023
DATE: 06/20/2023

DATE: 06/20/2023
DATE: 06/20/2023
DATE: 06/20/2023

DATE: 06/20/2023
DATE: 06/20/2023
DATE: 06/20/2023

DATE: 06/20/2023
DATE: 06/20/2023
DATE: 06/20/2023

DATE: 06/20/2023
DATE: 06/20/2023
DATE: 06/20/2023

DATE: 06/20/2023
DATE: 06/20/2023
DATE: 06/20/2023

DATE: 06/20/2023
DATE: 06/20/2023
DATE: 06/20/2023

DATE: 06/20/2023
DATE: 06/20/2023
DATE: 06/20/2023

DATE: 06/20/2023
DATE: 06/20/2023
DATE: 06/20/2023

DATE: 06/20/2023
DATE: 06/20/2023
DATE: 06/20/2023

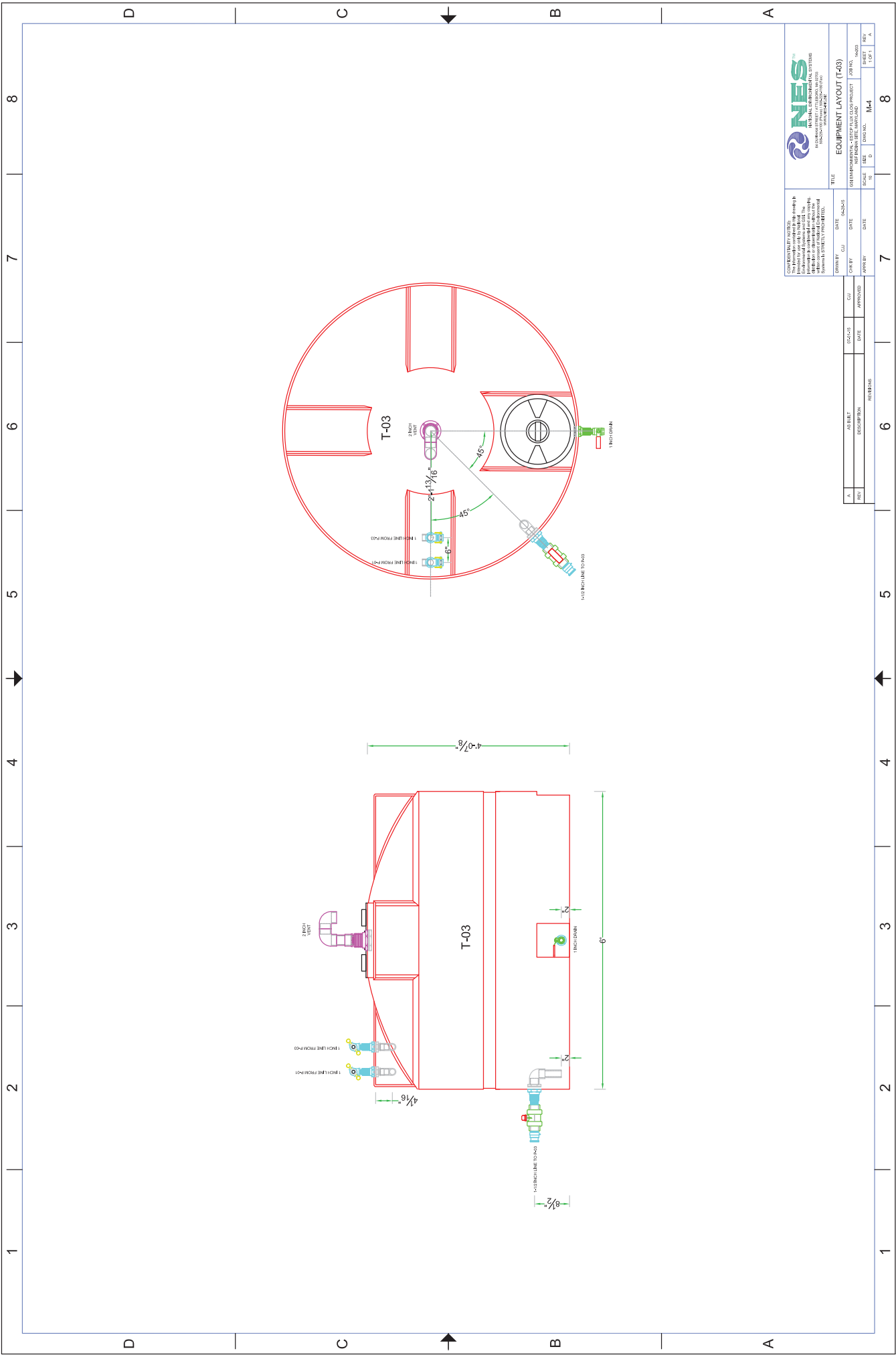

CONFORMANCE NOTICE:
 This drawing is a preliminary design and is subject to change without notice. It is not to be used for construction or procurement of materials without the written approval of the design engineer.

NO.	DESCRIPTION	DATE	BY	DATE	BY
AS BUILT					
APPROVED					

DATE	DATE	DATE	DATE	DATE

SCALE	DATE	DATE	DATE	DATE

NO.	DESCRIPTION	DATE	BY	DATE	BY

NO.	DESCRIPTION	DATE	BY	DATE	BY

NO.	DESCRIPTION	DATE	BY	DATE	BY

NO.	DESCRIPTION	DATE	BY	DATE	BY

NO.	DESCRIPTION	DATE	BY	DATE	BY

NO.	DESCRIPTION	DATE	BY	DATE	BY

NO.	DESCRIPTION	DATE	BY	DATE	BY

TITLE
 EQUIPMENT LAYOUT (T-03)

DESIGNER: []
 CHECKED: []
 DATE: []
 DATE: []
 DATE: []
 DATE: []

PROJECT: []
 SCALE: []
 SHEET: [] OF []

DATE: []
 DATE: []
 DATE: []
 DATE: []

NO. []
 DESCRIPTION []
 DATE []
 BY []
 DATE []
 BY []

NO. []
 DESCRIPTION []
 DATE []
 BY []
 DATE []
 BY []

NO. []
 DESCRIPTION []
 DATE []
 BY []
 DATE []
 BY []

INJECTION SKID OPERATION AND CONTROLS

During the grout mixing and injection processes, procedures will be employed to control the process and collect data. Manual controls will be available to control the following process variables:

Table E.1: Process Controls.

Control	Purpose
Shut-off valves	<ul style="list-style-type: none"> Control routing of flow from the water source and between various tanks.
Pressure Reducing Valve PRV-01	<ul style="list-style-type: none"> Control pressure supplied to manifold.
Throttling valve on discharge from Pump P-01	<ul style="list-style-type: none"> Control flow rate from fire hydrant through Pump P-01 to either Tank T-02 or T-04.
Throttling valve on discharge from Pump P-02	<ul style="list-style-type: none"> Control flow rate from Tank T-01 to Tank T-02 Control flow rate from Tank T-02 to Static Mixer SM-01.
Throttling valve on discharge from Pump P-03	<ul style="list-style-type: none"> Control flow rate from Tank T-03 to Tank T-04 Control flow rate from Tank T-04 to Static Mixer SM-01.
Backflow preventer	<ul style="list-style-type: none"> Prevent backflow from skid to water supply.
Check valves	<ul style="list-style-type: none"> Prevent backflow of mixed grout to upstream parts of skid.

Note: Shut-off valves and PRV-01 are shown on PFD. For clarity, throttling valves, backflow preventer, and check valves are not shown on the PFD but will be included in the final design.

During field work, measurements should be recorded on a routine specified basis to characterize the process and to facilitate determining design parameters for implementation of full-scale design. In addition, certain process variables should be measured to identify possible system malfunctions or undesirable conditions. Process measurements and possible malfunctions are summarized below:

Table E.2: Process Monitoring.

Data Point	Purpose
<i>Verify Process/Measure Quantity</i>	
Flow rate and total flow through Pump P-01	<ul style="list-style-type: none"> • Fill Tanks T-02 and T-04 with specified volume of water to achieve required dilution
Flow rate and total flow through Pump P-02	<ul style="list-style-type: none"> • Fill Tank T-02 with specified volume of NaSi (with or without EVO) to achieve required dilution • Determine volume of NaSi (with or without EVO) injected
Flow rate and total flow through Pump P-03	<ul style="list-style-type: none"> • Fill Tank T-04 with specified volume of accelerator to achieve required dilution • Determine volume of accelerator injected
Gallon markings on Tanks T-02 and T-04	<ul style="list-style-type: none"> • Verify volume of water pumped to Tanks T-02 and T-04 • Verify volume of NaSi (with or without EVO) pumped to Tank T-02 • Verify volume of accelerator pumped to Tank T-04
Pressure at Pressure Reducing Valve PRV-01	<ul style="list-style-type: none"> • Verify that pressure supplied to manifold within range (plus or minus) of specified injection pressure
Pressure on individual injection lines	<ul style="list-style-type: none"> • Verify that pressure supplied to manifold within range (plus or minus) of specified injection pressure
Flow rate though individual injection lines	<ul style="list-style-type: none"> • Estimate volume of grout delivered to each injection point or depth interval
<i>Identify Possible Malfunction or Undesirable Condition</i>	
Pressure on discharge of Pumps P-01, P-02, and P-03	<ul style="list-style-type: none"> • High pressure indicator of possible line blockage • Low pressure indicator of possible leak
Pressure on individual injection lines	<ul style="list-style-type: none"> • High pressure indicator of potential low flow and line clogging • High pressure indicator of potential formation fracturing
Sight flow indicator on individual injection lines	<ul style="list-style-type: none"> • Low or no flow indicator of potential line clogging • High flow indicator of potential formation fracturing
Flow rate though individual injection lines	<ul style="list-style-type: none"> • Low or no flow indicator of potential line clogging • High flow indicator of potential formation fracturing
Flow rate and pressure on individual injection line	<ul style="list-style-type: none"> • Sudden increase in flow rate at constant pressure in one or more injection lines may indicate fracturing of formation
Water levels in injection points adjacent to injection points being used for injection	<ul style="list-style-type: none"> • Increases in water levels could indicate possible surface breakthrough of grout.

**APPENDIX F HYDRAULIC CONDUCTIVITY CALCULATIONS
SMALL-SCALE DEMONSTRATION**

APPENDIX F Hydraulic Conductivity Calculations Small-Scale Demonstration

CALCULATION 1: CONSTANT HEAD AQUIFER TESTS

ES-1 ($k = 0.20$ ft/day)

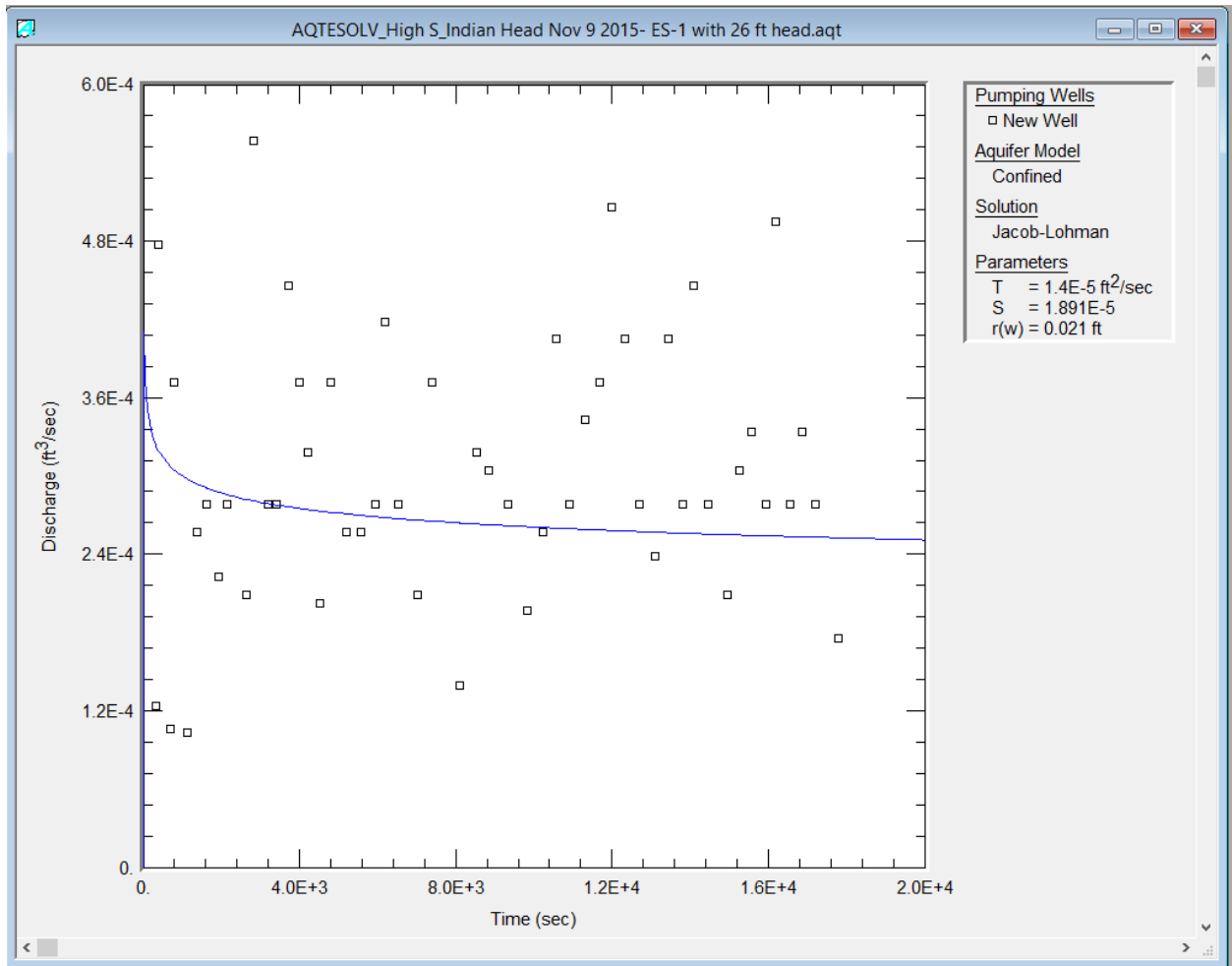

ES-2 (k = 0.21 ft/day)

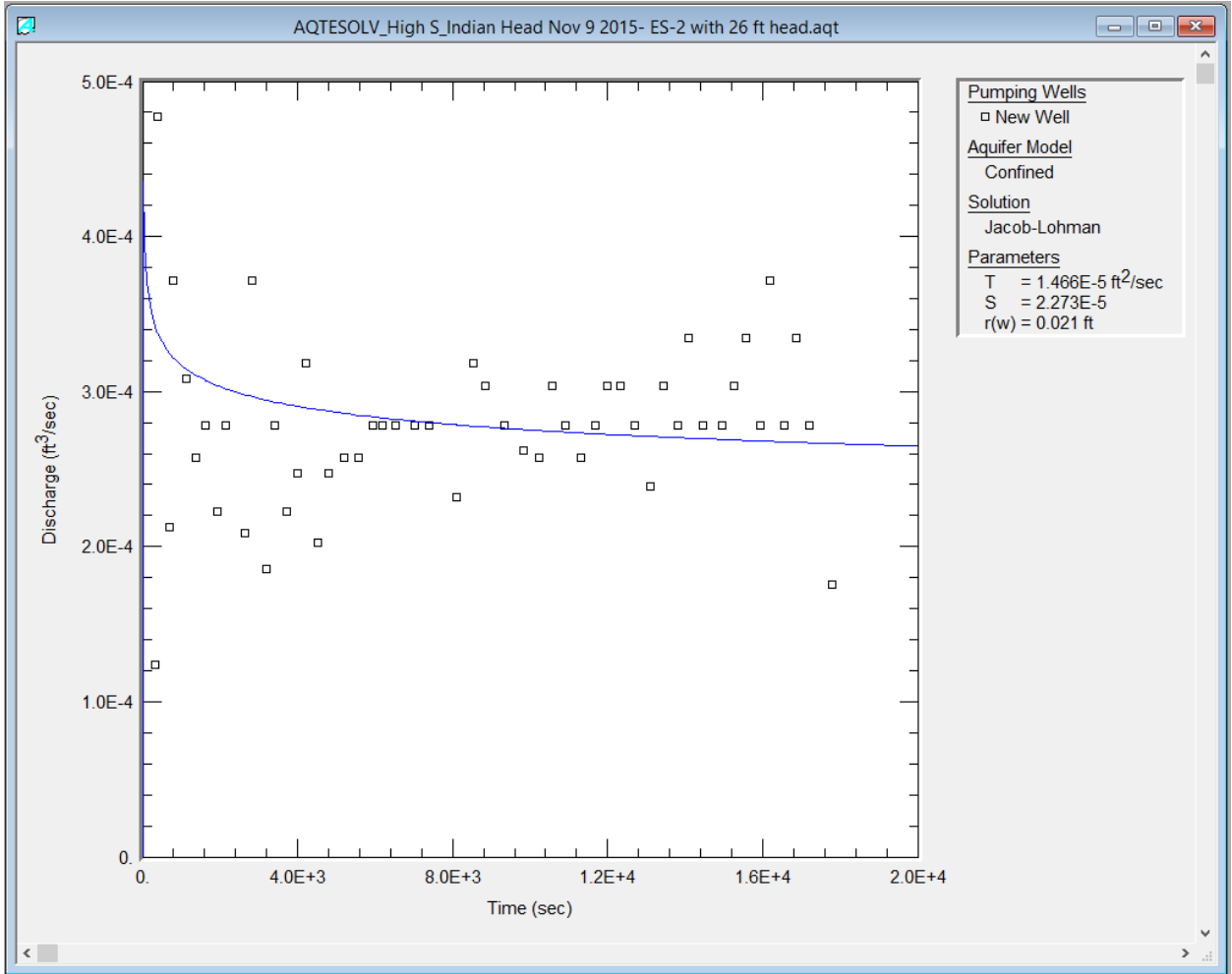

S-2 (k = 0.27 ft/day)

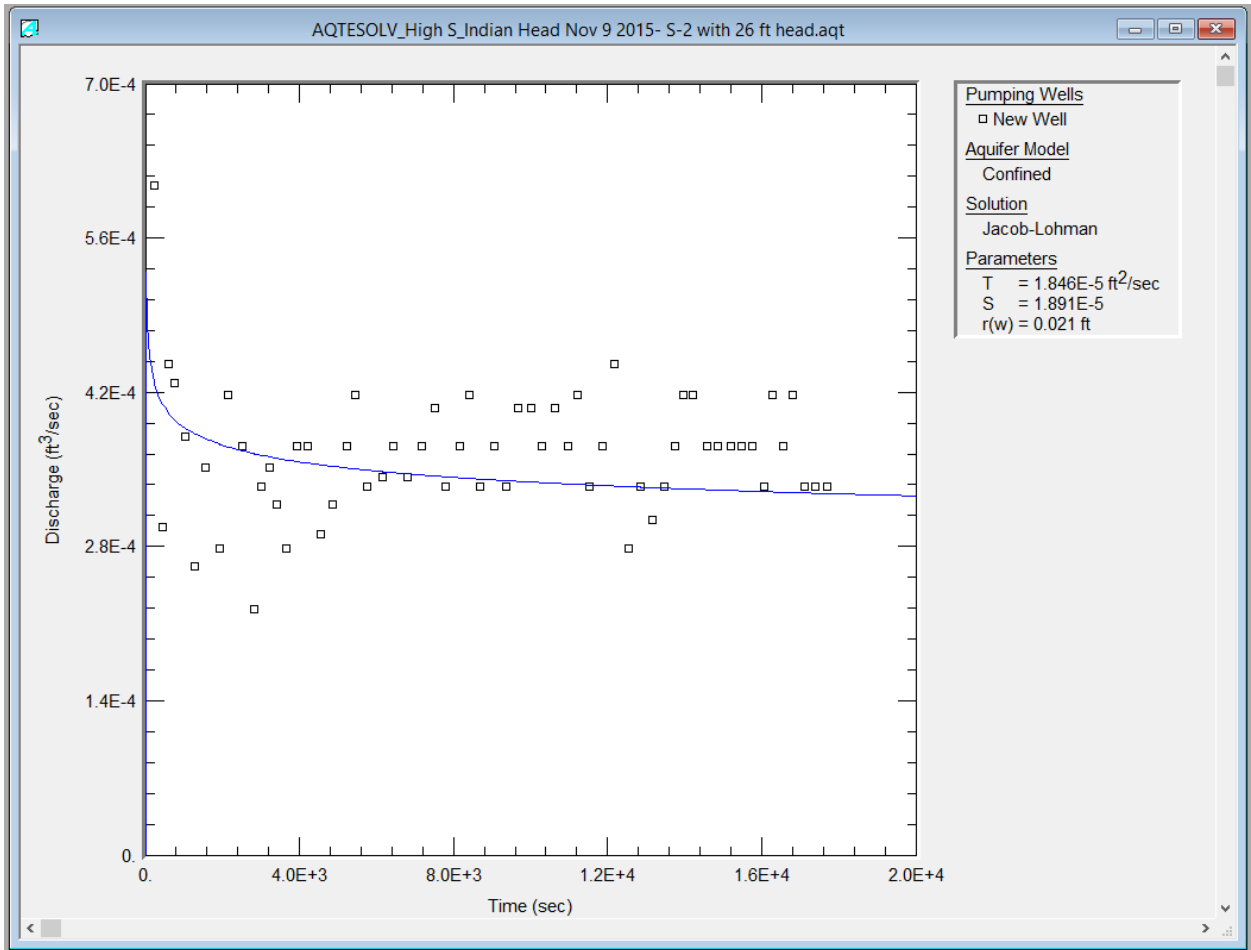

CALCULATION 2: REANALYSIS OF MW-3 SLUG TEST DATA

Original site report assumed saturated thickness 15 feet; changed this value to 6 feet to reflect 6 foot sand layer observed in MW-3. GSI reanalyzed all four slug tests using AQT SOLVE, Bower Rice, unconfined.

ORIGINAL K FOR MW-3 FROM REPORT	REANALYSIS
K (Ft/day)	K (Ft/day)
1.2	0.84
0.5	0.51
1.2	0.76
0.7	0.42
Avg: 0.90	Avg: 0.63

Dataset 1

Curve-Matching Using AQTESOLV

			yo	K (ft/day)
Early-Stage	9.73E-06	ft/s	1.81	0.84
Late Stage	5.86E-06	ft/s	0.963	0.51

Dataset 2

Curve-Matching Using AQTESOLV

			yo	K (ft/day)
Early-Stage	8.83E-06	ft/s	1.782	0.76
Late Stage	4.86E-06	ft/s	0.952	0.42

DATASET 1

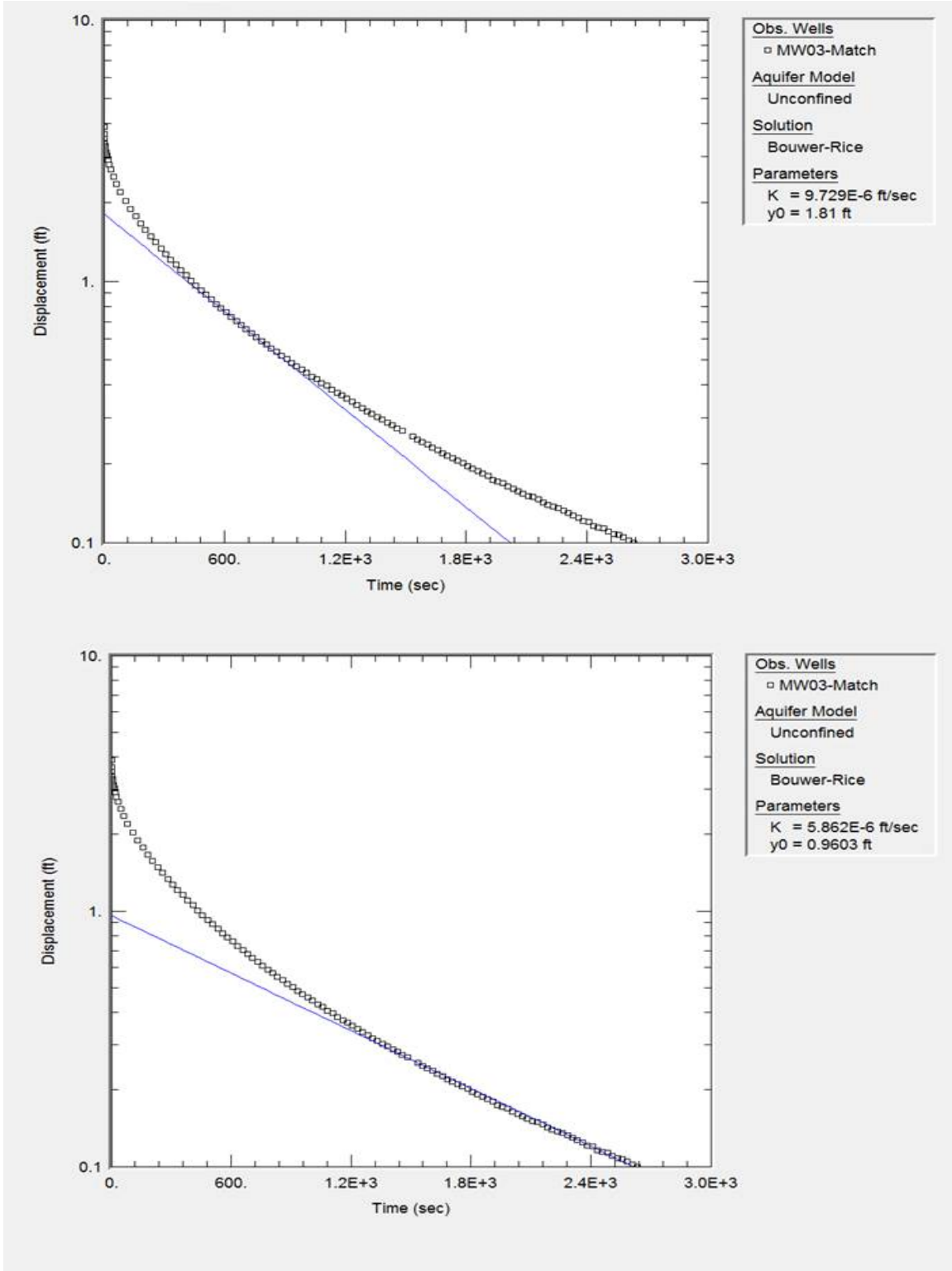

DATASET 2

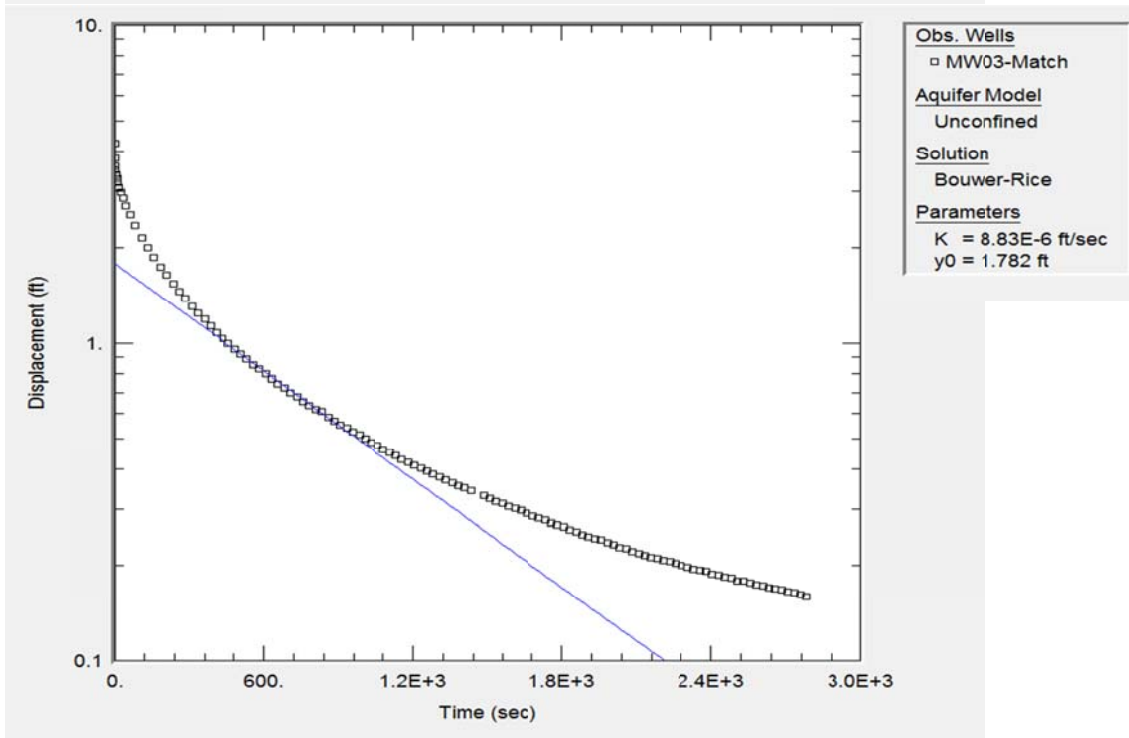
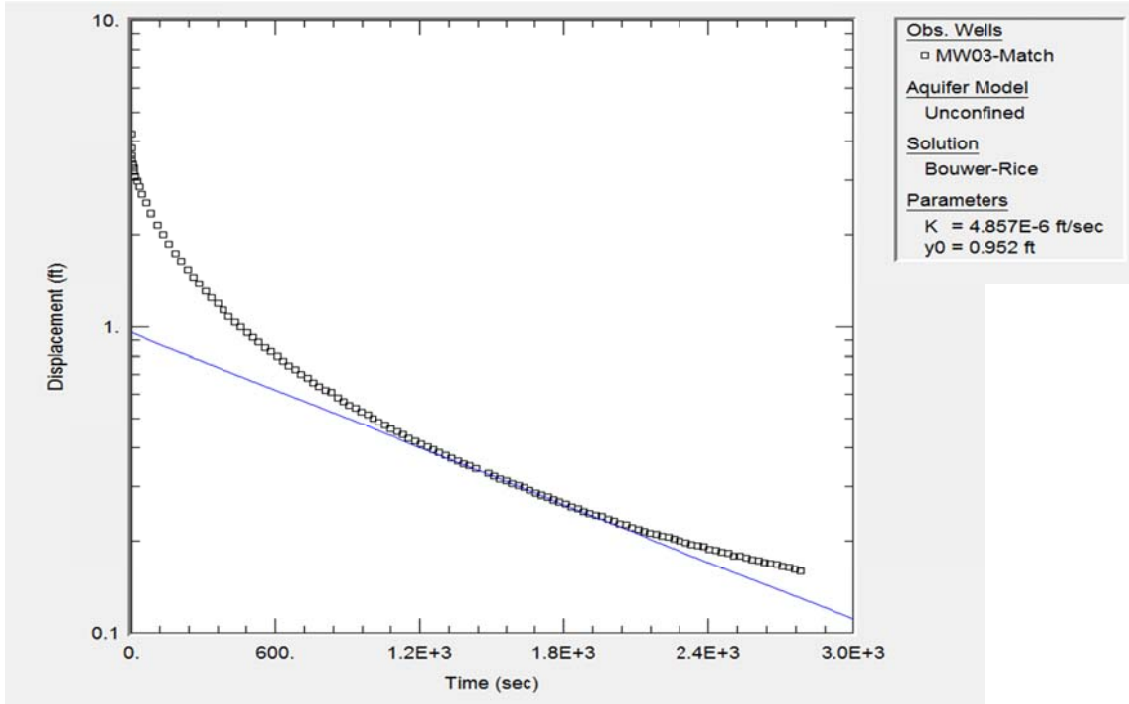

APPENDIX G POINTS OF CONTACT

Appendix G: Points of Contact

Point of Contact	Organization	Phone/Fax/email	Role in Project
Charles J. Newell	GSI Environmental, Inc. 2211 Norfolk, Suite 1000, Houston, TX 77098-4054	Phone : 713-522-6300 Fax : 713-522-8010 Email : cjnewell@gsi-net.com	PI
Poonam R. Kulkarni	GSI Environmental, Inc. 2211 Norfolk, Suite 1000, Houston, TX 77098-4054	Phone : 713-522-6300 Fax : 713-522-8010 Email : prk@gsi-net.com	Co-PI