

technical bulletin

CL:AIRE technical bulletins provide a source of detailed information on specific techniques, practices and methodologies currently being employed on sites in the UK within the scope of CL:AIRE technology demonstration and research projects. This technical bulletin focuses on multilevel sampling systems.

1. **DISCLAIMER:** This Technical Bulletin represents the situation in the UK as of January 2002.

2. Definitions of words written in bold type may be found in the Glossary of Terms within the Publications section of the CL:AIRE Web site at <http://www.claire.co.uk>

Multilevel Sampling Systems

1. INTRODUCTION

The topic of this CL:AIRE Technical Bulletin is **multilevel sampling systems** for characterising contaminated groundwater. Contaminated groundwater can present considerable problems for landowners: it can occur at significant depth; sources of the contamination are not often obvious; it can migrate from one property to another; and groundwater flow directions can be altered because of seasonal variations or pumping. In order to assess risk and liability associated with contaminated groundwater, landowners must be able to characterise both the nature and extent of any contamination.

Contaminant migration in **aquifer** systems can be a complex process, especially in fractured **bedrock**, and is both difficult and expensive to characterise. Sampling and monitoring at many different levels in the subsurface from one sampling location allows the actual or potential pathways for contaminant migration to be identified and monitored. The use of multilevel sampling systems allows landowners to optimise the amount of information they can obtain from their boreholes.

Several options are available currently for sampling groundwater at multiple levels from a "single" monitoring location. The first, termed "multiple completions" involves clusters or nests, which include individually installed monitoring wells in individual boreholes or several monitoring wells completed in a single borehole. The second involves manufactured multilevel sampling systems. These include simple continuous multichannel tubing and more complex engineered multilevel systems. The key features of the various manufactured systems are discussed below. A CL:AIRE research project which focuses on the **natural attenuation** of petrol contaminated groundwater in a chalk aquifer successfully applied one of the multilevel sampling systems described in this bulletin and is written up as a separate CL:AIRE Case Study Bulletin (CSB1).

2. TYPES OF MULTILEVEL SAMPLING SYSTEMS

The following types of multilevel sampling systems are discussed in this bulletin:

- Multiple Completions
- Continuous Multichannel Tubing
- Waterloo Multilevel System
- Westbay MP System

2.1 Multiple Completions

Multiple completions in bedrock involve the installation of more than one monitoring well in a single borehole (nested, Figure 2a), or a number of single monitoring well completions in boreholes drilled close together (clustered, Figure 2b). Each borehole is typically 150 mm or 200 mm in diameter and drilled using rotary coring or open hole method. For the purposes of this Technical Bulletin, discussion will be limited to commercially available well materials and will not consider "bundle" type monitoring wells.

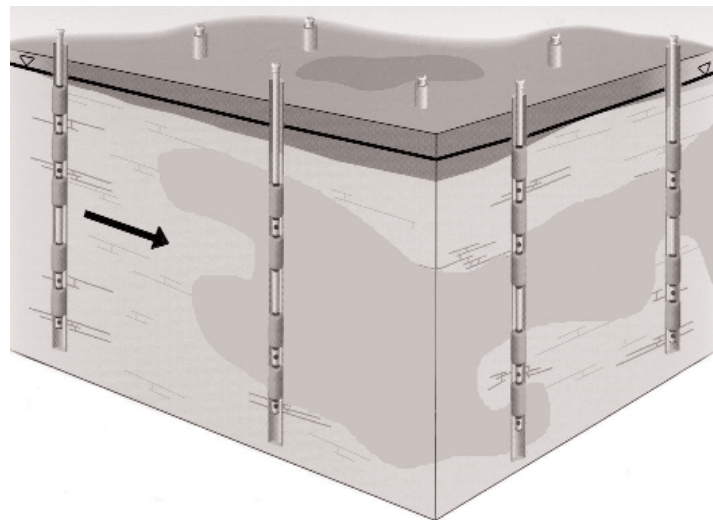

Figure 1: Schematic diagram of a typical multilevel well installation (adapted from Solinst Data Sheet)

Monitoring wells consist typically of 19 mm or 50 mm diameter plastic casing attached to a screen of either a perforated end section or a porous tip. The installation method will be similar for nested or clustered completions.

Each borehole is drilled and cleaned out to the desired depth. A 0.2 m layer of clean sand or gravel is placed at the base. The monitoring well is then placed vertically within the borehole while additional sand is placed around the screen to form a filter extending approximately 0.3 m above the top of the screen. It is good practice to seal the remainder of the hole with **bentonite** to avoid providing vertical pathways within the annular space of the borehole. When multiple installations are required in a single borehole then the process is repeated. There is a danger with multiple completions that sand packs and bentonite seals around the well screens are not securely placed, allowing groundwater to "short circuit" seals.

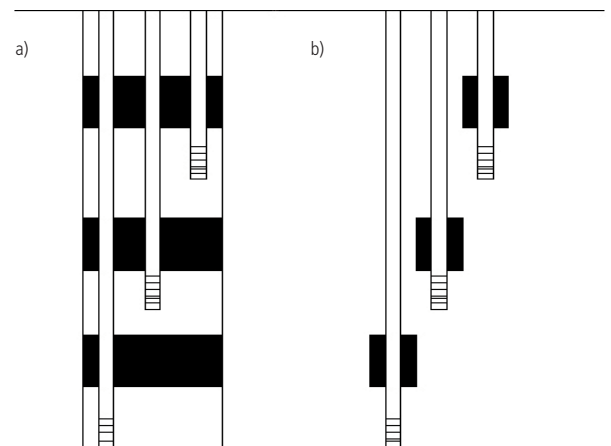

Figure 2: Layout of (a) nested and (b) clustered monitoring wells.

CL:AIRE (Contaminated Land: Applications In Real Environments) wishes to thank the following organisations for their support:

Department of the Environment (Northern Ireland) Department of the Environment, Food and Rural Affairs English Partnerships Environment Agency Scottish Enterprise
Scottish Environment Protection Agency Scottish Power Shanks Soil and Groundwater Technology Association UK Coal Unilever Viridor Waste Management Welsh Development Agency

2.2 CONTINUOUS MULTICHANNEL TUBING

2.2.1 Introduction

The Continuous Multichannel Tubing (CMT) multilevel system is an economical approach to multilevel groundwater monitoring providing the simplicity of a bundle type installation with the benefits of backfilling or sealing around a single tube. Each system can be custom-built on site without leaving the hole open to deterioration or contamination. CMT systems give the option of up to 7 monitoring zones in a single tube and are usually installed in 150 mm or larger diameter boreholes. The system has been installed to depths up to 90 m.

2.2.2 Components

CMT is a continuously extruded 7-chambered or channelled high density polyethylene (HDPE) tube with 43 mm OD. It is supplied in standard lengths of 30 m, 60 m or 90 m. There are no joints in the CMT, which removes the risk of leakage. Screened sections and seals can be located precisely where needed and are constructed on site. **Annular seals** are installed as backfilled bentonite layers.

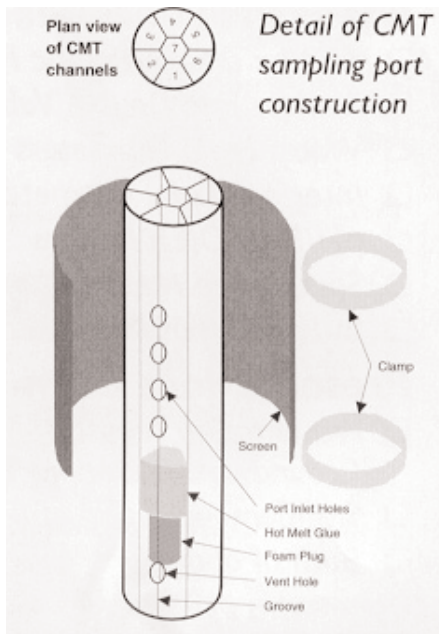

Figure 3: Detail of Solinst CMT sampling port construction.

Source: Solinst Canada Ltd

2.2.3 Installation

The best locations for monitoring ports and packed zones are determined from information taken from the borehole and core during or after drilling. A length of CMT tubing sufficient to reach from the surface to the deepest monitoring level is cut and the base is sealed, using a foam plug and HDPE hot melt glue, except for the central chamber which is used as the deepest monitoring port. The tubing is laid out on the ground and the locations for each port and **packer** (if packers are to be used) are marked. Ports are created by drilling holes in the appropriate channel. The base of the port is sealed with a foam plug and hot melt glue. The port area is wrapped with an appropriately-sized stainless steel mesh screen which is kept in place by stainless steel clamps. A vent hole is drilled below the sealed area to allow formation water to enter the chamber and reduce casing buoyancy. A detailed schematic of system components is provided in Figure 3. The system can also accommodate dedicated **pressure transducers**. Once all of the ports have been installed, the string is lowered into the hole to the desired depth and supported at the surface.

Alternating layers of bentonite and sand are carefully placed at the correct depth to ensure that monitoring ports are surrounded by sand and sealed above and below with bentonite.

2.2.4 Measurements/Sampling

Water levels can be measured using narrow diameter water level meters. Water samples can be collected using specialised samplers, **inertial pumps** or **peristaltic pumps**.

2.3 WATERLOO MULTILEVEL SYSTEM

2.3.1 Introduction

The Waterloo Multilevel System (WMS) is a modular system, which includes a closed casing string with up to 24 monitoring ports in each borehole, depending on system configuration. The system has been installed in a variety of hydrogeological environments to depths up to 230 m.

2.3.2 Components

WMS consists of casing components, which may be installed permanently or temporarily in the borehole. Individual, small diameter, lengths of tubing through the inside of the casing connect each isolated monitoring port to the surface, where they can be accessed for groundwater sampling, **hydraulic head** measurements and **hydraulic testing**.

System components include casing sections which come in a variety of lengths, monitoring ports, tubing, packers, end cap and a surface manifold. The standard system is manufactured in 50 mm diameter Schedule 80 PVC for installation inside a 75-100 mm diameter borehole. The casing and packer bodies are also available in stainless steel, with tubing available in stainless steel, nylon or Teflon®.

Sections of casing are connected by means of a patented system of nylon shear wires and O-rings. This gives a reliable, leakproof joint that has been tested to 900 kg tensile load and leak tested to 1375 kPa internal pressure.

PVC or stainless steel monitoring ports are typically isolated by packers (although backfill methods can also be used) at each desired monitoring zone and are individually connected to the surface manifold with narrow diameter tubing. Details of packers and ports are provided in Figure 4. The maximum number of monitoring zones attached to tubing that can be accommodated in a standard casing is 8. If dedicated pumps are added, then the maximum number drops to 5. If dedicated pressure transducers are installed alone then the maximum number of monitoring zones is 24.

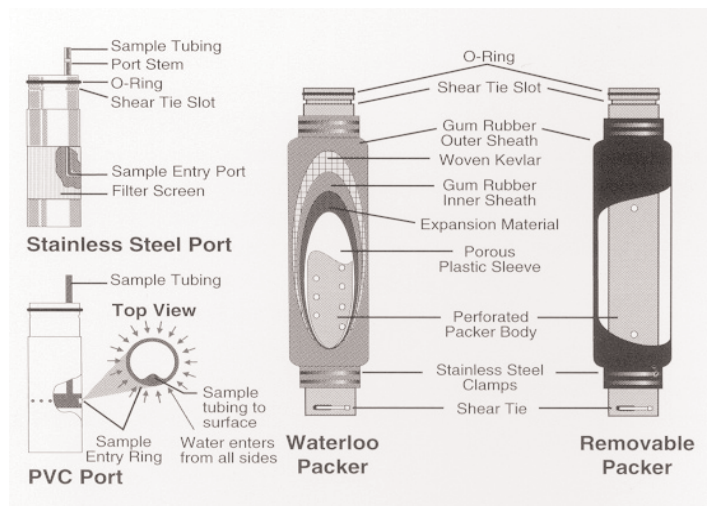

Figure 4: Waterloo ports and packers.

Source: Solinst Canada Ltd

Packers include a permanent type and a removable type. The permanent Waterloo packer uses a water activated sleeve fitted over the perforated packer body which expands to form an engineered seal against the borehole wall. Removable packers are made with natural gum rubber and are inflated hydraulically or pneumatically by pressurising the interior of the WMS casing string. These packers facilitate system maintenance and borehole decommissioning, simplify grouting of the hole and allow most of the system to be reused.

The manifold is placed at the top of the casing string. It ensures that the inside tubing and any cabling is kept separate and ordered, allowing a simple connection for operation of transducers or pumps.

2.3.3 Installation

A typical WMS can be installed quickly and easily by two people, in a few hours, without the use of a drilling rig. Starting with the base plug and lowermost sections, the components are joined together in the order required in the hole. A ground clamp supports the suspended string in the borehole as it is being assembled. As each new port is put into position a new monitoring tube, dedicated pump and/or transducer is connected to it. Successive components are threaded over these tubes and cabling, building the casing string. Installation of the manifold completes the system.

2.3.4 Measurements/Sampling

There are a number of options for monitoring. In open tubes, water levels can be measured using narrow diameter water level meters. Water samples can be collected using specialised samplers, inertial pumps or peristaltic pumps. Alternatively, dedicated pressure transducers and **gas drive pumps** can be installed.

2.4 WESTBAY MP SYSTEM

2.4.1 Introduction

The MP System is a modular multilevel system employing a single, closed access tube with valved ports, which provide access to different levels of a borehole through a single well casing. The modular design permits numerous monitoring zones to be established in a borehole and modifications can be made to the number and location of ports at the time of installation. The MP System has been used in many different geological and climatic environments in boreholes up to 1,200 m in depth.

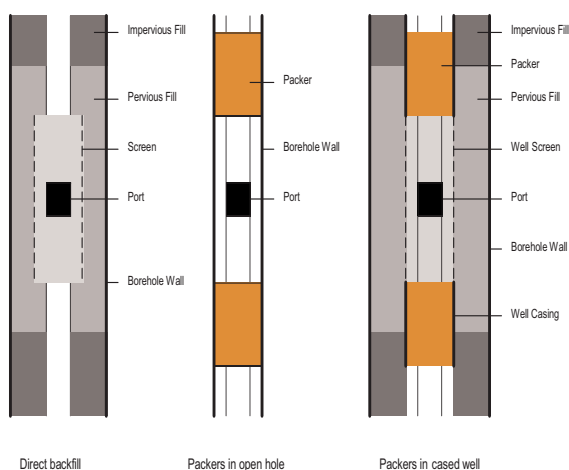

Figure 5: Common completion methods for both the Waterloo Multilevel System and the Westbay MP System (adapted from Solinst and Westbay corporate literature).

2.4.2 Components

The MP System consists of casing components, which are permanently installed in the borehole. Portable probes and specialised tools are used to take hydraulic measurements and groundwater samples.

The casing components include casing sections of various lengths, couplings, end caps and packers, which seal the annulus between the monitoring zones. The casing sections of the MP System are manufactured in either PVC or stainless steel in nominal lengths of 0.5 m, 1.5 m and 3.0 m and are available in 38 mm and 55 mm diameters. Regular couplings are used to connect casing lengths where valved couplings are not required. The couplings incorporate O-rings for a positive hydraulic seal and do not use adhesives. A flexible shear rod provides a tensile connection. Two types of valved couplings, measurement port couplings and pumping port couplings, allow measurement of fluid pressure and groundwater sampling, respectively. Monitoring ports are protected with nylon or stainless steel screens. End caps are placed on the bottom of a casing string. They incorporate an O-ring seal so that the entire casing string is hydraulically sealed during installation.

When there are many monitoring zones in a single borehole, annular seals are required to prevent fluid migration from one zone to another along the annular opening between the borehole wall and the casing. Annular seals can be installed by: a) backfilling with alternating layers of sand and bentonite or grout, b) using

hydraulic (water) inflated packers to seal between the casing string and the borehole wall or c) using packers inside a cased well with multiple screens, and the screened areas backfilled with alternating layers of sand and bentonite/grout. Types of annular seals are shown in Figure 5.

2.4.3 Installation

Prior to installation, subsurface horizons of interest are identified from site characterisation information and an installation log showing all of the component parts of the multilevel system is prepared. The system component parts are laid out at the site according to the sequence shown on the installation log and checked off the installation log as they are inserted into the borehole. Once installed, the packers are inflated proceeding from the bottom of the hole, or the system is backfilled.

2.4.4 Measurements/Sampling

Fluid pressure measurements, hydraulic conductivity testing, and fluid sampling can be carried out. Specialised sampling tools are sent down the hole on a cable attached to the control devices at the surface, and are positioned at the appropriate port. Individual fluid pressure measurements can be taken by manual control of a pressure probe. Alternatively the process can be automated allowing multiple samples to be collected. Hydraulic conductivity can be measured using variable head, constant head and pressure-pulse tests. Fluid samples are collected using a sampler probe, illustrated in Figure 6, which locks into position at the desired port. Once the sample is taken, the probe is returned to the surface where the sample is transferred to an appropriate container.

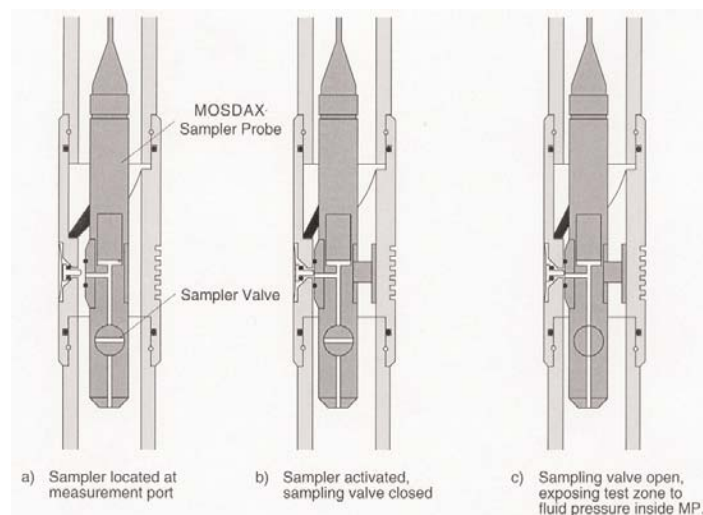

Figure 6: Using a Westbay sampler probe to measure fluid pressure. Source: Westbay Instruments Inc.

3. COSTS

Table 1 provides comparative costs for the different multilevel sampling systems discussed in this bulletin. These costs have been provided by the UK suppliers whose details are given in section 4. To try to ensure equivalent costing, the costs have been calculated for a 30 m deep borehole using four different sets of conditions (Scenarios 1-4) which vary according to the number of sampling ports (3 or 7) and the type of seal (backfill or packer seals) used to isolate each port. The costs are split into three categories: set-up costs; drilling costs; and downhole material costs which include initial tooling costs. The same basis for calculating the set-up and drilling costs has been used for the five sampling options to highlight the differences in downhole material costs. Total costs do not include delivery of the system, technical support or sampling/monitoring equipment.

For the three individual monitoring wells (both cluster and nested) depths of 10, 20 and 30 m are used in the calculations, and for the seven cluster monitoring wells depths of 4, 8, 12, 16, 20, 25 and 30 m. A problem with calculating the costs for seven nested monitoring wells is that it is too many to fit in a single borehole. For this option, therefore, an array of three boreholes is used in the calculation containing 3, 2 and 2 monitoring wells respectively, with corresponding monitoring well depths of 12, 20, 30 m for the triple installation and 4, 16 m and 8, 25 m for the two double installations.

Table 1: Illustrative costs for different multilevel sampling systems.

	No. of ports	Seal	Mobilisation costs (£)	Drilling costs (£)	Downhole Material Costs ¹ (£)	Total (£)
Individual Monitoring Well						
<i>Cluster type</i>						
Scenario 1	3	Backfill	240	960	840	2040
Scenario 2	7	Backfill	560	1792	1568	3920
<i>Nested type</i>						
Scenario 1	3	Backfill	80	480	612	1172
Scenario 2	7	Backfill	240	1136	1258	2634
Solinst CMT						
Scenario 1	3	Backfill	80	480	1400	1960
Scenario 2	7	Backfill	80	480	1550	2110
Solinst Waterloo System						
Scenario 1	3	Backfill	80	480	1910	2470
Scenario 2	7	Backfill	80	480	2660	3220
Scenario 3	3	Packer ²	80	480	2500	3060
Scenario 4	7	Packer ²	80	480	4100	4660
Westbay MP System						
Scenario 1	3	Backfill	80	480	4200	4760
Scenario 2	7	Backfill	80	480	6700	7260
Scenario 3	3	Packer ²	80	480	6800	7360
Scenario 4	7	Packer ²	80	480	11000	11560

¹ Including initial tooling costs.

² The costs of the packered seal for the Solinst Waterloo System and the Westbay MP System have been calculated using the cheapest available option.

Table 1 shows that the cheapest option for 3 sampling ports (Scenario 1) is to use a nested monitoring well configuration which is approximately half the price of the next cheapest options - the Solinst CMT and the individual cluster monitoring wells. However, for Scenario 2, involving 7 sampling ports, the Solinst CMT is less expensive than either of the individual monitoring wells options. This suggests that cost benefits for single borehole, multilevel systems (single mobilisation and drilling cost) are realised when a greater number of sampling ports are required, while for a small number, individual monitoring wells may be more cost effective. It should be borne in mind that nested monitoring wells can be difficult to install and that the integrity of the seals can be compromised if sand pack or bentonite seals are placed improperly.

Figure 7 compares the costs of the five different sampling options with an increasing number of ports (1-7), based on the information used for calculating the costs in Table 1. The figure illustrates that, for the example costs provided in Table 1, there are cross-over points where it becomes more cost-effective to use multilevel systems as opposed to individual monitoring wells (either cluster or nested). For Solinst CMT, the two sets of cross-over points are between 2-3 ports, and 5-6 ports for cluster and nested monitoring wells respectively. For the Solinst Waterloo System, there is a cross-over point between 4-5 sample ports for the cluster monitoring well, but no such point for the nested type.

The use of packers to seal sample ports increases the cost of each of the multilevel systems. However, it is not always beneficial to use them. For instance, packers will work effectively only if the rock is competent; if it is highly fractured then backfill methods may be more suitable.

The costs provided in Table 1 are for materials and installation only. Each system requires a different type of specialist sampling and/or monitoring equipment which will inevitably add to the total cost. This equipment varies significantly in terms of both complexity and availability, and ranges from simple off-the-shelf check valves in an individual monitoring well; to narrow diameter tubing for CMT and Waterloo systems and proprietary, highly specialised equipment for the Westbay MP System. For example, in the Westbay System it would cost upwards of £40,000 to purchase a cable reel, sampler probe, bottles and a readout unit. As a result, it is often more cost-effective to rent the equipment, along with trained engineers, at a rate of approximately £550/day.

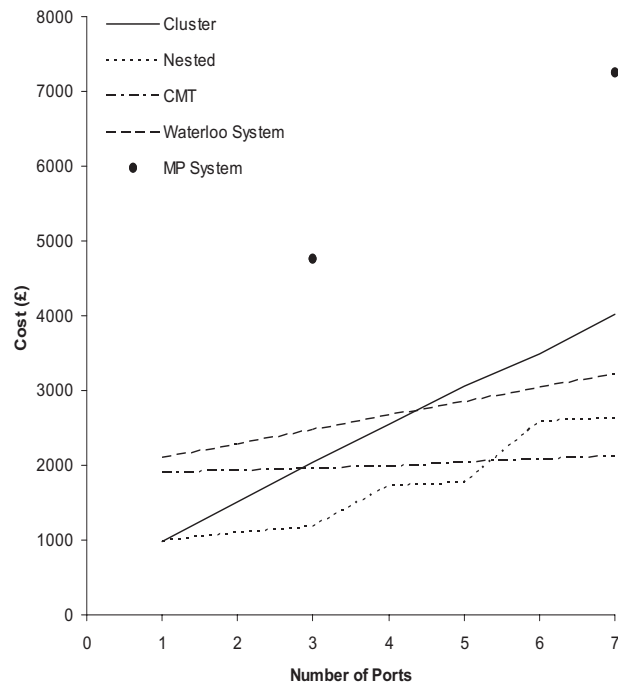

Figure 7: Cost comparison curves for different multilevel sampling systems.

It is important to understand that the selection of a groundwater sampling system is unlikely to be based solely on its cost. The chosen system must have the required level of functionality and sophistication for each specific application and this depends on the hydrogeology, contaminant characteristics, borehole conditions and the demands of the proposed monitoring scheme.

4 ADVANTAGES AND DISADVANTAGES

Advantages of manufactured multilevel samplers over multiple completions include:

- fewer drilled holes, reduced drilling and installation costs
- reduced site disturbance
- minimisation of purge water volumes, reducing handling and disposal costs.
- potentially improved hydraulic seals compared with nested systems

Disadvantages of manufactured multilevel samplers include:

- can be more difficult to install than individual monitoring wells, requiring the use of specialist contractors and field personnel
- decreased sampling rate requires longer sampling time.

CONTACT DETAILS

The CMT and Waterloo Multilevel Systems are products of Solinst Canada Ltd (www.solinst.com). The authorised agents for Solinst in the UK are Waterra (UK) Limited (www.WaterraUK.com): -
Contact Peter Dumble at
Unit 4, r/o 179-189 Stratford Road, Shirley, Solihull, West Midlands B90 3AU, UK
Tel: +44 (0) 121 733 7743. Fax: +44 (0) 121 733 7746
Email: sales@WaterraUK.com

The Westbay MP System is a product of Westbay Instruments Inc. (www.westbay.com). The authorised agents for Westbay in the UK are Soil Mechanics, a division of Environmental Services Group Limited:-
Contact: Peter Gee at
Askern Road, Carcroft, Doncaster, South Yorkshire, DN6 8DG
Tel: +44 (0) 1302 723456 Fax: +44 (0) 1302 725240
Email: pgee@esgl.co.uk