

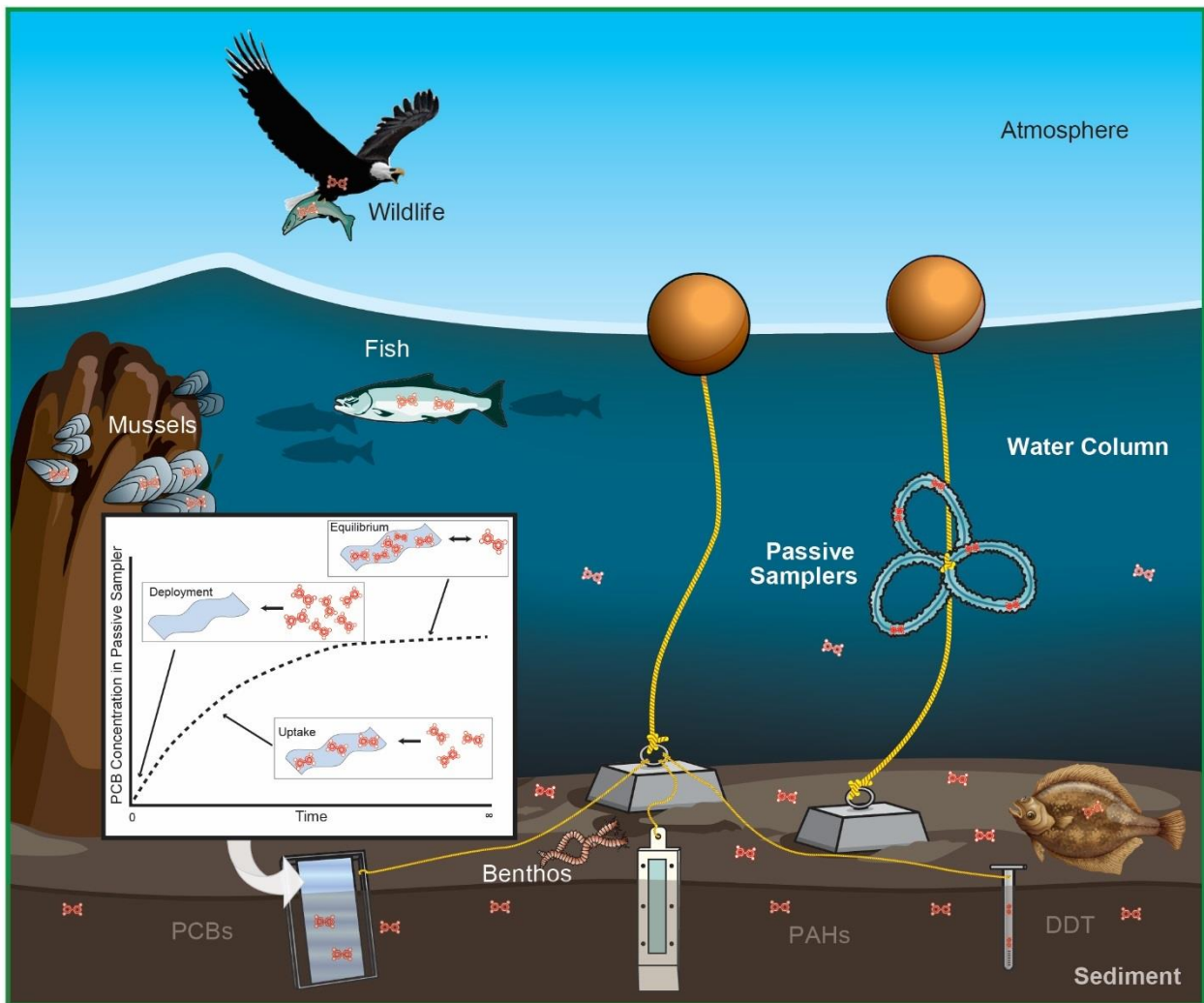

# Laboratory, Field, and Analytical Procedures for Using Passive Sampling in the Evaluation of Contaminated Sediments: User's Manual



February 2017 Final Web Version (1.0)



# Laboratory, Field, and Analytical Procedures for Using Passive Sampling in the Evaluation of Contaminated Sediments: User's Manual

Robert M. Burgess  
U.S. Environmental Protection Agency  
National Health and Environmental Effects Research Laboratory  
Atlantic Ecology Division, Narragansett, RI, USA

Susan B. Kane Driscoll  
Exponent, Inc.  
Maynard, MA, USA

G. Allen Burton  
Cooperative Institute for Limnology & Ecosystems Research  
University of Michigan Water Center  
Ann Arbor, MI, USA

Upal Ghosh  
Department of Chemical, Biochemical, & Environmental Engineering  
University of Maryland Baltimore County  
Baltimore, MD, USA

Philip M. Gschwend  
Parsons Laboratory for Environmental Science and Engineering  
Massachusetts Institute of Technology  
Cambridge, MA, USA

Danny Reible  
Department of Civil and Environmental Engineering  
Texas Tech University  
Lubbock, TX, USA

Sungwoo Ahn  
Exponent, Inc.  
Bellevue, WA, USA

Tim Thompson  
Science and Engineering for the Environment, LLC  
Seattle, WA 98105

U.S. Environmental Protection Agency  
Office of Research and Development  
National Health and Environmental Effects Research Laboratory  
Atlantic Ecology Division, Narragansett, RI 02882

Strategic Environmental Research and Development Program (SERDP)/  
Environmental Security Technology Certification Program (ESTCP)  
4800 Mark Center Dr.  
Alexandria, VA 22350

## Notice

The Department of Defense's Strategic Environmental Research and Development Program (SERDP)/Environmental Security Technology Certification Program (ESTCP) and U.S. EPA's Office of Research and Development (ORD) produced this document as a guide for using passive sampling to evaluate contaminated sediments. The document is intended to cover the laboratory, field, and analytical aspects of passive sampler applications. This document will be useful for developing user-specific laboratory, field and analytical procedures and as a complement to existing sediment assessment tools. This document should be cited as:

U.S. EPA/SERDP/ESTCP. 2017. Laboratory, Field, and Analytical Procedures for Using Passive Sampling in the Evaluation of Contaminated Sediments: User's Manual. EPA/600/R-16/357. Office of Research and Development, Washington, DC 20460

Most information in this document has been funded wholly by the DOD's Strategic Environmental Research and Development Program/Environmental Security Technology Certification Program with some content provided by the U.S. Environmental Protection Agency. This document has been subjected to Agency peer and administrative review and has been approved for publication as an EPA document.

Mention of trade names or commercial products does not constitute endorsement or recommendation for use. This document is U.S. EPA Science Inventory #308731.

For optimum readability, print and view this document in color. Further, when printing the document pdf, make sure that sufficient dots per inch (dpi) are used to attain acceptable resolution (e.g., 300-400 dpm).

# Executive Summary

Addressing the human and ecological health risks associated with contaminated sediments represents one of the most wide-spread and technically challenging environmental problems. In the United States, monitoring programs coordinated by the U.S. Environmental Protection Agency (U.S. EPA), National Oceanic and Atmospheric Administration (NOAA) and other organizations have documented that vast quantities of freshwater and marine sediments are moderately to severely contaminated with chemical pollutants (Daskalakis and O'Connor 1995, U.S. EPA 1996a, b, 1997a,b,c, 1998, 2004). Further, several other countries around the world also wrestle with related contaminated sediments issues (e.g., Australia, New Zealand, the Netherlands, China, the United Kingdom [Babut et al. 2005, Chen et al. 2006]). Based on surveys performed in the United States, the quantities of contaminated sediments present in the environment approach billions of metric tons. To reduce or eliminate the human and ecological health risks manifested by these sediments, federal, state, local, and tribal regulatory authorities have a range of remedial technologies available including dredging, various forms of capping, and natural monitored recovery (NMR) (U.S. EPA 2005a). Each technology has advantages and disadvantages including effectiveness and costs. For example, the on-going remediation of the Hudson River Superfund site involves the removal, via dredging, of over two million metric tons of contaminated sediments at a potential cost of over a billion dollars (<http://www.epa.gov/superfund/accomp/success/hudson.htm>). Estimated costs associated with managing all contaminated sediments in terms of remediation and post-operational monitoring are in the tens of billions of U.S. dollars (U.S. EPA 2005a).

Regardless of the remedial technology invoked to address contaminated sediments in the environment, there is a critical need to have tools for designing and assessing the effectiveness of the remedy. In the past, these tools have included chemical and biomonitoring of the water column and sediments, toxicity testing and bioaccumulation studies performed on site sediments, and application of partitioning, transport and fate modeling. All of these tools served as lines of evidence for making informed environmental management decisions at contaminated sediment sites. In the last ten years, a new tool for assessing remedial effectiveness has gained a great deal of attention. Passive sampling offers a tool capable of measuring the freely dissolved concentrations ( $C_{free}$ ) of legacy contaminants in water and sediments. In addition to assessing the effectiveness of the remedy, passive sampling can be applied for a variety of other contaminated sediments site purposes involved with performing the preliminary assessment and site inspection, conducting the remedial investigation and feasibility study, preparing the remedial design, and assessing the potential for contaminant bioaccumulation (U.S. EPA 2005a).

While there is a distinct need for using passive sampling at contaminated sediments sites and several previous documents and research articles have discussed various aspects of passive sampling (e.g., Vrana et al. 2005, Lohmann 2012, Reible and Lotufo 2012, Smedes and Booij 2012, U.S. EPA 2012a, b, Ghosh et al. 2014, Mayer et al. 2014, Peijnenburg et al. 2014), there has not been definitive guidance on the laboratory, field and analytical procedures for using passive sampling at contaminated sediment sites. This document is intended to provide users of passive sampling with the guidance necessary to apply the technology to evaluate contaminated sediments. The contaminants discussed in the document include primarily polychlorinated biphenyls (PCBs), polycyclic aromatic hydrocarbons (PAHs), and the metals, cadmium, copper, nickel, lead and zinc. Other contaminants including chlorinated pesticides

and dioxins and furans are also discussed. The document is divided into ten sections each discussing aspects of passive sampling including the different types of samplers used most commonly in the United States, the selection and use of performance reference compounds (PRCs), the extraction and instrumental analysis of passive samplers, data analysis and quality assurance/quality control, and an extensive list of passive sampling related references. In addition, the document has a set of appendices which discuss facets of passive sampling in greater detail than possible in the main document. More specifically, included in the appendices are two examples of quality assurance project plans (QAPPs). This information is intended to provide a sound foundation for passive sampler users to apply this technology. This document does not, however, cover the critical planning process that would be used to arrive at the need for passive sampling. Additional information on the planning process can be found in the guidance document, Integrating Passive Sampling Methods into Management of Contaminated Sediment Sites (ESTCP 2016).

This document is not intended to serve as a series of standard operating procedures (SOPs) for using passive samplers at contaminated sediment sites. Rather, the document seeks to provide users with the information needed to develop their own SOPs or similar procedures. To this end, along with the information provided in the document, the names of selected passive sampling experts are listed who can be contacted to answer specific questions about the laboratory, field and analytical procedures associated with passive sampling. Additional information on passive samplers (including this document), SOPs and case studies can also be found on the ESTCP and U.S. EPA Superfund websites:

<https://www.serdp-estcp.org/Featured-Initiatives/Cleanup-Initiatives/Bioavailability>

<https://www.epa.gov/superfund/superfund-contaminated-sediments-guidance-document-fact-sheets-and-policies>

# Contents

1.	Introduction .....	1
1.1	Objectives of User’s Manual .....	1
1.2	Background .....	1
1.3	Types of Passive Samplers and Deployments .....	4
1.4	Principles of the Passive Sampling of Target Hydrophobic Organic Contaminants .....	9
1.5	Principles of the Passive Sampling of Metals .....	11
1.6	Applications .....	13
1.6.1	Hydrophobic Organic Contaminants .....	13
1.6.2	Metals .....	14
1.7	Additional Passive Sampler Needs and Current Resources .....	15
1.8	Commercial Laboratory Considerations .....	16
1.8.1	Use of Project Teams .....	16
1.8.2	Role of this Document’s Methods .....	17
1.8.3	Defining “Immediately” in this Document .....	17
1.8.4	Availability of Passive Sampler Partition Coefficients .....	17
1.9	Document Overview .....	23
2.	Passive Sampling with Polyoxymethylene (POM) .....	24
2.1	Introduction .....	24
2.2	Laboratory Preparation .....	24
2.2.1	POM Selection and Pre-Cleaning .....	25
2.2.2	Selection of POM:Sediment Ratio .....	25
2.2.3	Selection of Sediment Mass to be used for $C_{\text{free}}$ Determinations .....	26
2.2.4	Exposure Time and Conditions .....	26
2.2.5	Use of Biocides to Inhibit Target Contaminant Biodegradation .....	26
2.3	Field Use .....	27
2.3.1	In situ Deployment Device Designs .....	27
2.4	Recovery and Processing .....	27
2.5	Extraction and Instrumental Analysis .....	29
2.6	Data Analysis .....	29
2.7	Selection of Published POM-Water Partition Coefficients ( $K_{\text{POM}}$ ) .....	29
2.8	Empirical Determination of $K_{\text{POM}}$ Partition Coefficients .....	29
3.	Passive Sampling with Polydimethylsiloxane (PDMS) .....	31
3.1	Introduction .....	31
3.2	Laboratory Preparation .....	34
3.2.1	Pre-cleaning and Ex situ Deployment .....	34
3.3	Field Use .....	34
3.3.1	Pre-deployment Preparation .....	34
3.3.2	In situ Deployment .....	35
3.4	Recovery and Processing .....	36
3.5	Extraction and Instrumental Analysis .....	37
3.6	Data Analysis .....	37
3.7	Selection of Published PDMS-Water Partition Coefficients ( $K_{\text{PDMS}}$ ) .....	37
4.	Passive Sampling with Low-Density Polyethylene (LDPE) .....	39
4.1	Introduction .....	39

4.2	Laboratory Use.....	39
4.2.1	Pre-Deployment Preparation .....	39
4.2.2	Ex situ Deployment .....	40
4.3	Field Use .....	40
4.4	Recovery and Processing .....	42
4.5	Extraction and Instrumental Analysis .....	44
4.6	Data Analysis .....	44
4.7	Selection of Published Low-Density Polyethylene-Water Partition Coefficients ( $K_{LDPE}$ ).....	44
5.	Passive Sampling with Diffusive Gradient in Thin Films (DGT).....	45
5.1	Introduction.....	45
5.2	Preparation and Laboratory Use .....	47
5.3	Field Use .....	47
5.4	Recovery and Processing .....	48
5.5	Extraction and Instrumental Analysis .....	48
5.6	Data Analysis .....	48
6.	Selection and Use of Performance Reference Compounds for Hydrophobic Organic Target Contaminants .....	49
6.1	Introduction.....	49
6.2	Using Performance Reference Compounds (PRCs) .....	49
6.2.1	Selecting PRCs .....	49
6.2.2	Loading PRCs.....	50
6.2.3	Determining the Quantity of PRC to Load into Passive Samplers.....	53
6.2.4	Example Calculation .....	54
6.2.5	Chemical Analysis of PRCs following Deployment.....	55
7.	Extraction and Instrumental Analysis of Target Contaminants from Passive Sampling .....	56
7.1	Introduction.....	56
7.2	Extraction for POM, PDMS, and LDPE.....	60
7.2.1	Extraction of POM .....	60
7.2.2	Extraction of PDMS .....	60
7.2.3	Extraction of LDPE .....	63
7.3	Instrumental Chemical Analysis for POM, PDMS and LDPE .....	65
7.3.1	Instrumental Detection Limits for POM, PDMS and LDPE .....	65
7.4	Extraction of DGT .....	69
7.5	Instrumental Chemical Analysis of DGT .....	69
7.5.1	Instrumental Detection Limits for DGT .....	69
8.	Data Analysis: Calculation of $C_{free}$ and $C_{DGT}$ .....	70
8.1	Introduction.....	70
8.2	POM, PDMS, and LDPE Data Analysis.....	71
8.2.1	Equilibrium Conditions .....	72
8.2.2	Non-Equilibrium Conditions using PRCs .....	72
8.2.3	Example Calculations: Equilibrium versus Non-Equilibrium Conditions .....	75
8.3	DGT Data Analyses .....	83
8.3.1	Example DGT Calculations.....	83
8.4	Case Studies .....	83
9.	Quality Assurance and Quality Control, and Other Considerations .....	84
9.1	Introduction.....	84



9.2 Hydrophobic Organic Contaminant Polymer-Specific Quality Assurance and Quality Control.....	85
9.2.1 Polymer-Specific Deployment Blanks (i.e., trip blanks, field blanks).....	85
9.2.2 Field Solvent Blanks .....	85
9.2.3 Field Control Samples .....	85
9.2.4 Field Internal Standards.....	86
9.2.5 Recoveries of Surrogate Standards (also known as Internal Standards).....	86
9.2.6 PRC-Loaded Passive Sampler Reproducibility.....	86
9.2.7 QC Samples for Chemical Analysis .....	86
9.2.8 Specific Quality Assurance for POM.....	86
9.2.9 Specific Quality Assurance for PDMS.....	87
9.2.10 Specific Quality Assurance for LDPE.....	87
9.2.11 Passive Sampling Example Sampling and Analysis Project Plan (SAP) and Quality Assurance Project Plan (QAPP) .....	88
9.3 DGT-Specific Quality Assurance and Quality Control .....	88
9.3.1 DGT Quality Control.....	88
9.3.2 DGT Quality Assurance .....	88
10. References .....	90
<b>Appendix A: Provisional Passive Sampler Partition Coefficients (<math>K_{PS}</math>) for PCBs and PAHs .....</b>	<b>103</b>
<b>Appendix B: Additional Passive Sampler Partition Coefficient Information .....</b>	<b>107</b>
<b>Appendix C: Effects of Temperature and Salinity on Polymer-Water Partition Coefficients .....</b>	<b>115</b>
<b>Appendix D: Diffusion Coefficients (D) for Metals used in DGTs .....</b>	<b>117</b>
<b>Appendix E: Quality Guidelines for Hydrophobic Organic Contaminant Analysis .....</b>	<b>118</b>
<b>Appendix F: Case Studies.....</b>	<b>127</b>
<b>Appendix G: Example Quality Assurance Project Plan (QAPP) .....</b>	<b>153</b>

## Figures

Figure 1-1. Molecular structures of the polymers used to sample target hydrophobic organic contaminants. ....	6
Figure 1-2. Images of passive samplers discussed in this document.....	6
Figure 1-3. Molecular structures of the iminodiacetate acid functional group.....	7
Figure 1-4. Images of two common configurations of DGT passive samplers .....	7
Figure 1-5. Illustration of different deployment configurations for the passive samplers.....	8
Figure 1-6. Cartoon showing the three stages of passive sampler operation.....	10
Figure 2-1. Polyoxymethylene passive sampler strip in a laboratory vial.....	28
Figure 2-2. Polyoxymethylene passive sampler strips.....	28
Figure 3-1. Schematic of solid phase microextraction fiber showing the outer coating of polydimethylsiloxane.....	32
Figure 3-2. Insertion of a PDMS coated SPME fiber into whole sediments .....	32

Figure 3-3. Shielded and unshielded holders for PDMS coated SPME fibers with insets .....	33
Figure 3-4. SPME fibers configured to be wrapped in fine stainless steel mesh.....	33
Figure 4-1. Sequence of steps used to prepare passive samplers for <i>in situ</i> field deployment.....	40
Figure 4-2. Schematic of a LDPE passive sampling configuration using two aluminum sheet frames ...	41
Figure 4-3. LDPE film deployed inside an aluminum mesh packet. ....	42
Figure 4-4. Photographs of various systems for deploying LDPE in the water column .....	43
Figure 4-5. Photograph of LDPE in an aluminum frame after deployment .....	43
Figure 5-1. Schematic of commercial DGT disks in (a) cross-section and (b) DGT sediment probes in exploded view .....	46
Figure 5-2. Theoretical diagram of metal concentrations in the DGT device .....	46
Figure 5-3. Photograph of the <i>ex situ</i> deployment of DGT samplers in simulated water column.....	47
Figure 6-1. Sequence of steps used to prepare passive samplers for field deployment.....	52
Figure 7-1. Illustration of basic steps involved in preparing an <i>in situ</i> deployed passive sampler .....	58
Figure 8-1. Flow chart of the approaches for analyzing passive sampler data .....	73
Figure 8-2. Flow chart for selecting the appropriate PRC Correction Calculator .....	74
Figure 8-3. Primary data entry points and basic layout of the graphical user interface .....	76
Figure 8-4. Example output from the GUI for the PDMS PRC Correction Calculator.....	77
Figure 8-5. Primary data entry points and basic layout of the GUI.....	78
Figure 8-6. Example output from the GUI for the sediment deployment LDPE PRC Correction Calculator.....	79
Figure 8-7. Primary data entry points and basic layout of the GUI.....	80
Figure 8-8. Example of data entry window ('UserForm1').....	80
Figure 8-9. Example output from the GUI for the water column deployment .....	81

## Tables

Table 1-1. Commonly used sources of passive sampling polymers and DGT supplies. ....	5
Table 1-2. Application of passive samplers at selected U.S. EPA Superfund sites.....	18
Table 1-3. Advantages and disadvantages of different types of passive samplers .....	19
Table 1-4. List of academic and governmental technical contacts .....	20
Table 1-5. Examples of commercial analytical laboratories.....	22
Table 1-6. Additional costs for commercial laboratories.....	23
Table 6-1. Example <sup>a</sup> performance reference compounds (PRCs) .....	53
Table 7-1. Summary of extraction and analytical methods for passive samplers.....	59
Table 7-2. Representative target contaminant detection limits <sup>a</sup> for POM. ....	67
Table 7-3. Representative target contaminant detection limits for PDMS. ....	68
Table 7-4. Representative target contaminant detection limits for LDPE.....	69
Table 8-1. Example calculations of $C_{free}$ for 11 PCB congeners and total PCBs .....	82
Table 9-1. Summary of quality assurance and quality control samples .....	84

# Acknowledgements

## Scientific Contributions

Steve Ells	U.S. EPA, Office of Land and Emergency Management, Washington, DC, USA
Loretta Fernandez	Northeastern University, Boston, MA, USA
Abbey Joyce	National Research Council, U.S. EPA, Office of Research and Development, Narragansett, RI, USA
Matthew Lambert	U.S. EPA, Office of Land and Emergency Management, Washington, DC, USA
Keith Maruya	Southern California Coastal Water Research Project Authority, Costa Mesa, CA, USA
Monique Perron	U.S. EPA, Office of Chemical Safety and Pollution Prevention, Office of Pesticides, Washington, DC, USA
Ariette Schierz	Exponent, Inc., Maynard, MA, USA

## Technical Reviewers

Mark Cantwell	U.S. EPA, Office of Research and Development, Narragansett, RI, USA
Patricia DeCastro	CSRA, International, Narragansett, RI, USA
Loretta Fernandez	Northeastern University, Boston, MA, USA
Sandra Fogg	U.S. EPA, Office of Research and Development, Narragansett, RI, USA
Kay Ho	U.S. EPA, Office of Research and Development, Narragansett, RI, USA
Alan Humphrey	U.S. EPA, Region 2, Edison, NJ, USA
Abigail Joyce	National Research Council, U.S. EPA, Office of Research and Development, Narragansett, RI, USA
Matthew Lambert	U.S. EPA, Office of Land and Emergency Management, Washington, DC, USA
Joseph LiVolsi	U.S. EPA, Office of Research and Development, Narragansett, RI, USA
Patricia McIssac	Test America, Oakton, VA, USA
Thomas Parkerton	ExxonMobil Biomedical Sciences Inc. Spring, Texas, USA
Kathleen Schweitzer	United States Coast Guard, Warwick, RI, USA
Sean Sheldrake	U.S. EPA, Region 10, Seattle, WA, USA

# Acronyms

A	surface area of DGT exposed to sediment
AVS	acid volatile sulfides
BLM	biotic ligand model
CB	chlorinated biphenyl
CCV	continuing calibration verification
$^{13}\text{C}_{12}$	Carbon <sup>13</sup> labelled form a compound
$C_{\text{DGT}}$	diffusion gradient in thin film concentration
$C_e$	metal concentration in acid extract
$C_{\text{free}}$	freely dissolved concentration
$C_{\text{ITW}}$	interstitial water or porewater concentration
$C_{\text{LDPE}}$	low density polyethylene concentration
$C_{\text{PDMS}}$	polydimethylsiloxane concentration
$C_{\text{Polymer DL}}$	detection limit for the passive sampler concentration
$C_{\text{POM}}$	polyoxymethylene concentration
$C_{\text{PRCi}}$	performance reference compound initial concentration
$C_{\text{PRCf}}$	performance reference compound final concentration
$C_{\text{PS}}$	passive sampler concentration
$C_{\text{PS}}^{\text{non-eq}}$	non-equilibrium passive sampler concentration
$C_{\text{Sed}}$	target contaminant sediment concentration
$C_{\text{W}}$	water concentration
$C_{\text{W DL}}$	method detection limit of water using a given passive sampler
COD	coefficient of determination
D	diffusion coefficient of the resin gel
$D_x$	Deuterated labelled form of a compound
DDD	dichlorodiphenyldichloroethane
DDE	dichlorodiphenyldichloroethylene
DDT	dichlorodiphenyltrichloroethane
DGT	diffusive gradient in thin films
DI	deionized water
DOC	dissolved organic carbon
DOD	Department of Defense
EICP	extracted ion current profile
EPA	U.S. Environmental Protection Agency
EqP	equilibrium partitioning
$f_e$	elution factor
$f_{\text{eq}}$	fraction equilibrium
$f_{\text{eq}}^{\text{m}} \text{ PRC}^x$	measured fractional equilibrium for PRC
GC	gas chromatography
GC/ECD	gas chromatography/electron capture detection
GC/ELCD	gas chromatography/electrolytic conductivity detector
GC/MS	gas chromatography/mass spectrometry
GC/FID	gas chromatography/flame ionization detector
GUI	graphical user interface
HOC	hydrophobic organic chemical
HPLC	high-performance liquid chromatography

HRGC	high-resolution gas chromatography
HRMS	high-resolution mass spectrometry
ICAL	initial calibration for all analytes
ICP-MS	inductively coupled plasma mass spectrometry
ICP-OES	inductively coupled plasma optical emission spectrometry
ICV	initial calibration verification
$k_e$	exchange rate constant for the target contaminant
$K_D$	sediment-water partition coefficient
$K_f$	SPME fiber-water partitioning coefficient (approximately equivalent to $K_{PDMS}$ )
$K_{LDPE}$	low-density polyethylene-water partitioning coefficient
$K_{OW}$	octanol-water partitioning coefficient
$K_{PDMS}$	polydimethylsiloxane-water partitioning coefficient
$K_{POM}$	polyoxymethylene-water partition coefficient
$K_{PS}$	passive sampler-water partition coefficient
$K_S$	Setschenow constant
LCS	laboratory control sample
LDPE	low-density polyethylene
LFER	linear free energy relationship
LRMS	low-resolution mass spectrometry
M	mass of metal in resin gel
MDL	method detection limit
MGP	manufactured gas plant
MRL	method reporting limit
MS	mass spectrometry
n	sample size
$n_{\text{Detection}}$	mass of contaminant detected
NAPL	non-aqueous phase liquid
NOAA	National Oceanic and Atmospheric Administration
NMR	Natural monitored recovery
PAH	polycyclic aromatic hydrocarbon
PCB	polychlorinated biphenyl
PCC	PRC correction calculator
PCDD	polychlorinated dioxin
PCDF	polychlorinated diphenyl furan
PDMS	polydimethylsiloxane
PE	polyethylene
PED	polyethylene device
POM	polyoxymethylene
PPE	personal protective equipment
PQL	practical quantitation limit
PRC	performance reference compound
PS	passive sampler or passive sampling
PSD	passive sampling device
PSM	passive sampling method
QA-QC	quality assurance, quality control
R	gas constant (8.31 J/mol K)
$R_{DGT}$	ratio of $C_{DGT}$ to $C_{ITW}$
RRT	relative retention time

RSD	relative standard deviation
[salt]	salt concentration
SD	standard deviation
SE	standard error
SEM	simultaneously extracted metals
SETAC	Society of Environmental Toxicology and Chemistry
SOP	Standard operating procedures
SPMD	semi-permeable membrane device
SPME	solid-phase micro-extraction
SS	stainless steel
SVOC	semi-volatile organic compound
T	environmental temperature (in K)
T <sub>d</sub>	DGT sampler deployment time
TLD	toggle-locking device
TOC	total organic carbon
V <sub>e</sub>	volume of acid extract including any liquid added for dilution
V <sub>g</sub>	volume of resin gel
VOC	volatile organic contaminants
V <sub>PS</sub>	volume of passive sampler polymer
V <sub>s</sub>	volume of solvent
Δg	diffusive gel and membrane filter thickness
ΔH <sup>E</sup>	excess enthalpy of solution for the target compound dissolved in water

*Section 1*

# Introduction

## 1.1 Objectives of User's Manual

The primary objective of this document is to serve as a reference for using passive samplers with contaminated sediments. The types of target contaminants of interest include hydrophobic organic compounds (HOCs) such as polychlorinated biphenyls (PCBs), polycyclic aromatic hydrocarbons (PAHs), chlorinated pesticides, including dichlorodiphenyl-trichloroethane (DDT) and its metabolites, polychlorinated dioxins and furans, and divalent transition metals such as cadmium, copper, nickel, lead, and zinc. Because of the abundance of available data, with regard to the HOCs, this document focuses on PCBs and PAHs. As more information becomes available, future editions of this document may include other target contaminants. Specific information is provided for the preparation, deployment, recovery, chemical analysis, and data analysis of passive samplers. Ideally, this information can be used by commercial, academic, and government laboratories to prepare standard operating procedures (SOPs) and quality assurance project plans (QAPPs) for the performance of passive sampling. Examples of two QAPPs (including some SOPs) and several case studies are included in the appendices and are discussed later in this document. In addition, examples of SOPs for passive sampling are available at the ESTCP website. However, because of the need to address several different types of passive samplers and the various activities associated with those samplers for their use, sufficient space was not available for this document to be all inclusive or to be considered as a comprehensive source of actual passive sampling SOPs. Rather, a great deal of technical information and resources are

discussed and provided, that are intended to encourage potential passive sampler users to develop their own specific documentation.

## 1.2 Background

Sediments affected by historic and on-going discharges of contaminants may serve as repositories of metals and organic contaminants (Baker 1980a, b; Dickson et al. 1987; National Research Council. 1989; Baudo et al. 1990; Di Toro et al. 1991; Burton. 1992; Ingersoll et al. 1997; Wenning et al. 2005; Burgess et al. 2013) and may also function as a source of contamination to overlying water by processes such as resuspension, upwelling, interstitial water irrigation and diffusion (Larsson 1985; Salomons et al. 1987; Burgess and Scott 1992). Given the critical role of sediments in the overall environmental quality of aquatic ecosystems, by acting as habitat and interacting with the water column, it is important to understand the fate, transport, bioavailability, bioaccumulation, and toxicity of sediment-associated contaminants.

To assess the adverse effects of sediment contaminants on aquatic ecosystems, researchers initially focused on total concentrations of contaminants in sediment (e.g., Long and Chapman 1985). This effort, however, was often complicated by varying sediment compositions and complex partitioning of contaminants in sediments. For example, sediments with similar total concentrations often exhibited different magnitudes of impact on transport behavior, bioavailability, bioaccumulation, and toxicity (Adams et al. 1985; Di Toro et al. 1991).

Eventually, efforts to better understand and model the complexities of contaminated sediments resulted in the use of organic carbon normalization to predict the behavior of HOCs, because this sediment component was shown to strongly influence contaminant partitioning among particles, suspended solids, biota, and the water column. These observations resulted in the development and use of what came to be called the equilibrium partitioning (EqP) approach. Eventually, the U.S. EPA used EqP to derive sediment quality benchmarks for several HOCs (Burgess et al. 2013; U.S. EPA 2003, 2008). In addition, a similar EqP approach was also developed for several toxic transition metals (Ag, Cd, Cu, Ni, Pb, Zn), in which sediment acid volatile sulfides (AVS) and organic carbon were found to strongly limit their bioavailability. For example, by measuring acid volatile sulfide (AVS) and simultaneously extracted metals (SEM) and then calculating the molar difference between the two (SEM-AVS) or the molar ratio (AVS:SEM), the amount of metal in excess of sulfides can be estimated (Allen et al. 1991; U.S. EPA 2005b). Many studies have demonstrated that sediments with SEM-AVS <0 are non-toxic, because all the potentially toxic metal is precipitated and non-bioavailable as metal sulfides (Di Toro et al. 1992; Burton et al. 2005; U.S. EPA 2005b; Burgess et al. 2013). Although the AVS approach works well for predicting non-toxic conditions, for potentially toxic conditions (e.g., sediments with SEM-AVS >0), there is substantial variability, with many sediments that exceed toxic thresholds eliciting no toxic response (U.S. EPA 2005b; Costello et al. 2011). This lack of a toxic response above non-toxic thresholds is likely due to other binding phases that are not accounted for effectively in current metals EqP models. For some metals, particulate organic carbon also reduces their bioavailability, so AVS and organic carbon are often used in combination to predict metal toxicity in sediments (Burgess et al. 2013; U.S. EPA 2005b). U.S. EPA's guidance for EqP-based sediment quality benchmarks for metals also

recommends comparison of interstitial water concentrations of metals to ambient water quality criteria, to predict potential toxicity of sediment-bound metals (U.S. EPA 2005b).

Limitations in the predictive ability of EPA's EqP-based sediment quality benchmarks for some HOCs and metals have been noted (U.S. EPA 2012a, b). While the EqP approaches were able to reduce the variability in the evaluation of HOCs in some sediments, additional variability was seen that could not be entirely explained by organic carbon normalization. A preliminary explanation for this variability was that the sediment carbon was not homogeneous; as it forms from several different sources and types of carbon. Different types of organic carbons (e.g., fresh plant matter, soot, chars) exhibit different binding with HOCs (e.g., adsorption, absorption), which results in different partitioning behavior represented as a wide range of the partitioning coefficients (Gustafsson et al., 1997; Accardi-Dey and Gschwend 2002; Arp et al. 2009; Cornelissen et al. 2005; Kukkonen et al. 2005; Luthy et al. 1997; Pignatello and Xing 1995). For metals, the challenges in predicting bioavailability include the high degree of spatial and temporal variability that has been observed for AVS in the field. Much of this variability results from changes in the oxidation/reduction potential of the sediment, which alters sediment metals speciation and AVS formation (Cantwell et al. 2002; Wenning et al. 2005). For example, the resuspension of sediments can result in the oxidation of AVS with subsequent release of bound metals, the partitioning of metals to Fe- and Mn-oxyhydroxides in oxic surficial sediments, and the movement of benthic organisms between oxic and anoxic zones in the sediments can change metal speciation and thus bioavailability. In addition, the collection of metal-contaminated sediments is technically challenging because these redox zones can change over spatial scales of just a few millimeters. Further, there is the potential for



AVS oxidation in the sediment collection, transport, and measurement processes.

The principle underlying these EqP-based approaches was to predict whether sufficient quantities of contaminants, HOCs or metals, in a bioavailable form were present to cause adverse biological or ecological effects. The freely dissolved concentration ( $C_{\text{free}}$ ) of a given contaminant is considered a viable surrogate for the actual bioavailable concentration (Di Toro et al. 1991; Schwarzenbach et al., 2003; Lohmann et al., 2004; Burgess et al. 2013; Mayer et al. 2014). The  $C_{\text{free}}$  is directly related to a contaminant's chemical activity, and it represents the driving force governing diffusive uptake of contaminants from sediment interstitial waters into benthic organisms and the partitioning into the overlying water column. While EqP-based models attempt to predict  $C_{\text{free}}$ , as discussed above, the complexity of partitioning in sediment systems can introduce considerable uncertainty to such modeling exercises. Similarly, conventional efforts to simply sample the  $C_{\text{free}}$  for HOCs from sediment interstitial waters using centrifugation and squeezing methods have proven both successful and unsuccessful, depending on the circumstances (Carr and Nipper 2003). Common problems associated with isolating interstitial water include collecting sufficient volumes for chemical and toxicological analyses and dealing with artifacts introduced by the isolation procedures. Therefore, in recent years, research has focused on developing methods to more simply, but accurately, sample  $C_{\text{free}}$ . Ideally, such a method would eliminate the requirement to completely understand the partitioning of target contaminants in complex sediment systems and the need to isolate large volumes of interstitial water or provide sufficient target contaminant for acceptable analytical detection (Ghosh et al. 2000).

Over the last ten years, passive sampling has been proposed as an alternative means to measure  $C_{\text{free}}$  (Booij et al. 1998; Mayer et al.

2000; DiFilippo and Eganhouse 2010; Jonker and Koelmans 2001; Zhang and Davison 1995; Fernandez et al., 2009b; Mayer et al. 2014; Ghosh et al. 2014; Peijnenburg et al. 2014; Dong et al. 2015). Considerable information on passive samplers has been compiled and presented in a series of papers from the 2012 Society of Environmental Toxicology (SETAC) Pellston workshop on passive sampling (Lydy et al. 2014; Mayer et al. 2014; Ghosh et al. 2014). Passive samplers, made of organic polymers, are devices that are placed in contact with sediment, surface water, or groundwater for sufficient time to allow target contaminants to reach equilibrium with the sampler and other environmental phases (e.g., colloids, particles, organisms). Concentrations of target contaminants in the retrieved passive sampler are isolated and measured via extraction and chemical instrumental analysis. This concentration associated with the sampler ( $C_{\text{PS}}$ ) is used to calculate the  $C_{\text{free}}$  for HOCs and a Diffuse Gradient in Thin Films (DGT) based  $M$  value which allows for the calculation of  $C_{\text{DGT}}$  for metals. The concentration of contaminants in the sampler ( $C_{\text{PS}}$  or  $C_{\text{DGT}}$ ) can also be compared to bioaccumulation by benthic and water-column organisms (Vinturella et al. 2004; Lohmann et al., 2004. Friedman et al. 2009; Gschwend et al. 2011; Simpson et al. 2012). As passive sampling has been used more and more often, several advantages over the indirect measurements of  $C_{\text{free}}$  have been identified, including low detection limits; minimal interference from colloids and particulate matter; simple implementation, with no need for large volumes of sediment or water for extractions; and in some instances, the ability to mimic bioaccumulation in aquatic organisms. Limitations associated with passive sampling include logistical challenges of deployment at some sites, long duration times to achieve equilibrium (see later discussion), and an incomplete understanding of the relationship to bioavailability in some organisms.

### 1.3 Types of Passive Samplers and Deployments

In North America, the most widely used materials to construct passive samplers include low-density polyethylene (LDPE), polyoxymethylene (POM), and polydimethylsiloxane (PDMS) for sampling of HOCs as target contaminants (Figures 1-1, 1-2). For metals, most passive sampling has used the diffusive gradient in thin films (DGT) sampler which uses a chelating resin to capture labile metal ions (Figures 1-3). Table 1-1 provides examples of manufacturers of the passive samplers discussed in this document. Various configurations of the three HOC samplers are possible in terms of their size and shape, but currently, two major configurations are generally used: (1) sheets and thin films, and (2) coatings. LDPE and POM are most often used as thin sheet- or film-forms in various thickness, shapes, and dimensions (Figure 1-2a, b). In contrast, PDMS is mostly applied as a coating on a solid support such as thin glass fibers (i.e., solid-phase microextraction (SPME)) (Vrana et al. 2005; U.S. EPA 2012b) (Figure 1-2c). For metals (as discussed below) several passive sampling

approaches have been used over the years including interstitial water peepers, Teflon sheets, and cation exchange resins. However, DGTs have been used most frequently to assess labile metals in water, soils, and sediments (Peijnenburg et al. 2014). Currently, DGTs are available in two configurations: disks (Figure 1-4a) and flat rectangular probes (Figure 1-4b). DGTs have been used for approximately 20 years to measure the flux of metals in environmental samples. The majority of studies have applied DGTs in surface waters and soils, with a much smaller set of studies assessing metals in a sediment matrix. Again, the DGT provides information on the flux of labile metals from the environment into the sampler, not the actual metal  $C_{\text{free}}$  value (See Sections 1.5, 1.6.2 and 8.3 for further discussion). Also note that this flux depends on the combination of all diffusing species (not just  $\text{Zn}^{+2}$ , for example). There is disagreement within the scientific community as to whether the labile fraction is predictive of toxicological effects or not. Figure 1-5 illustrates how these passive samplers are deployed to collect target contaminants from contaminated sediments. The following sections describe these deployments in more detail.

**Table 1-1. Commonly used sources of passive sampling polymers and DGT supplies.**

<b>Passive Sampler</b>	<b>Manufacturer</b>	<b>Contact Information</b>	<b>Polymer Thickness (<math>\mu\text{m}</math>)</b>
Polyoxymethylene (POM)	CS Hyde Company 1351 N. Milwaukee Avenue Lake Villa, IL, USA 60046 <a href="http://www.cshyde.com/">http://www.cshyde.com/</a>	sales@cshyde.com 800 461 4161	38 and 76
Polydimethylsiloxane (PDMS)	Fiberguide Industries 1 Bay Street Stirling, NJ, USA 07980 <a href="http://www.fiberguide.com">http://www.fiberguide.com</a>	908 647 6601	Check with manufacturer
	Polymicro Technologies Inc. A Subsidiary of Molex Incorporated 18019 N. 25th Avenue Phoenix, AZ USA 85023-1200 <a href="http://www.polymicro.com">http://www.polymicro.com</a>	polymicrosales@molex.com 602 375 4100	30 $\mu\text{m}$ /500; 30 $\mu\text{m}$ /1000 $\mu\text{m}$ ; 30 $\mu\text{m}$ /100 $\mu\text{m}$  (polymer layer /core thickness)
Low Density Polyethylene (LDPE)	Purchased as “drop cloth” for painting at hardware stores. Manufacturer names listed on the packaging include:	-	12, 25, 50 and 75
	-Brentwood Plastics, Inc., Brentwood, MO -Carlisle Plastic, Inc., Minneapolis, MN -Trimaco, Durham, NC -Film-Gard, Minneapolis, MN		
Diffusive Gradients in Thin Film (DGT)	DGT Research Ltd. Skelmorlie, Bay Horse Road, Quernmore, Lancaster, LA2 0QJ, UK <a href="http://www.dgtresearch.com">http://www.dgtresearch.com</a>	h.zhang@lancaster.ac.uk 44 1524 593899	Not applicable

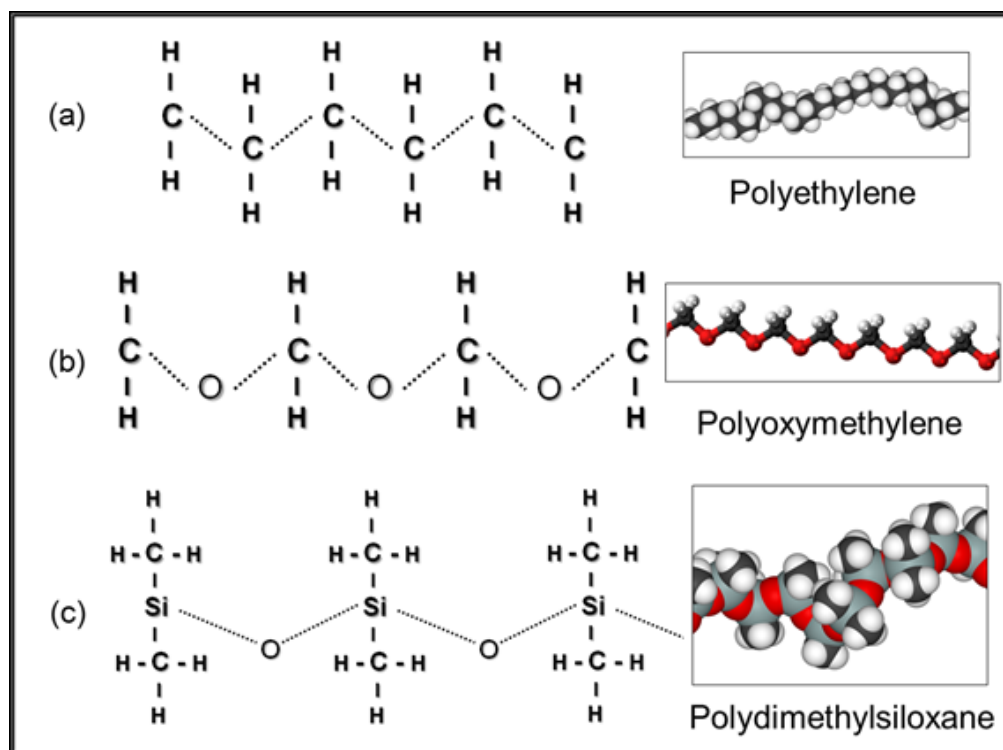

Figure 1-1. Molecular structures of the polymers used to sample target hydrophobic organic contaminants.

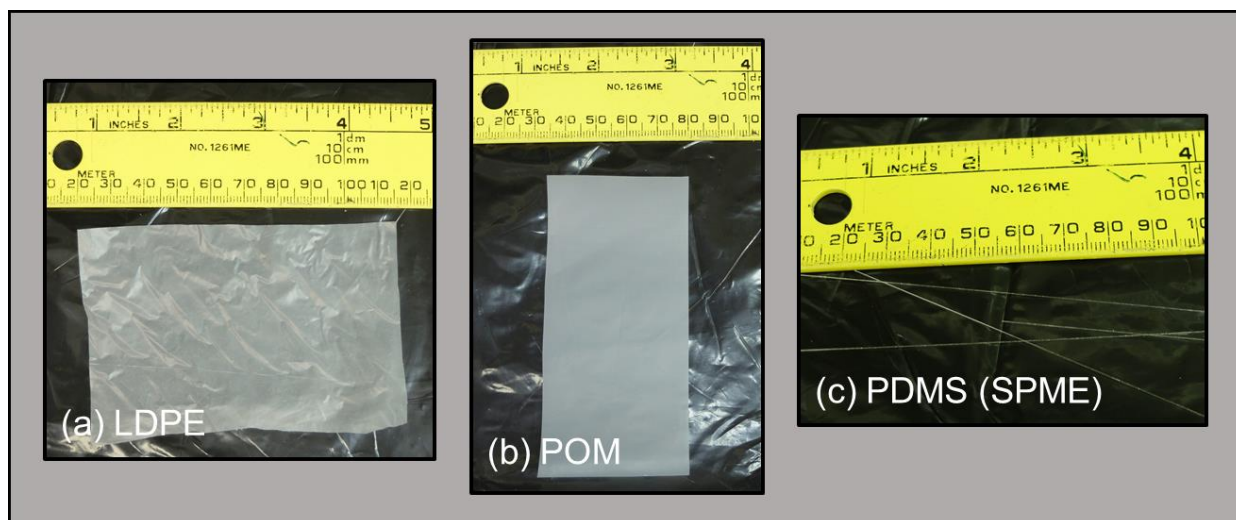
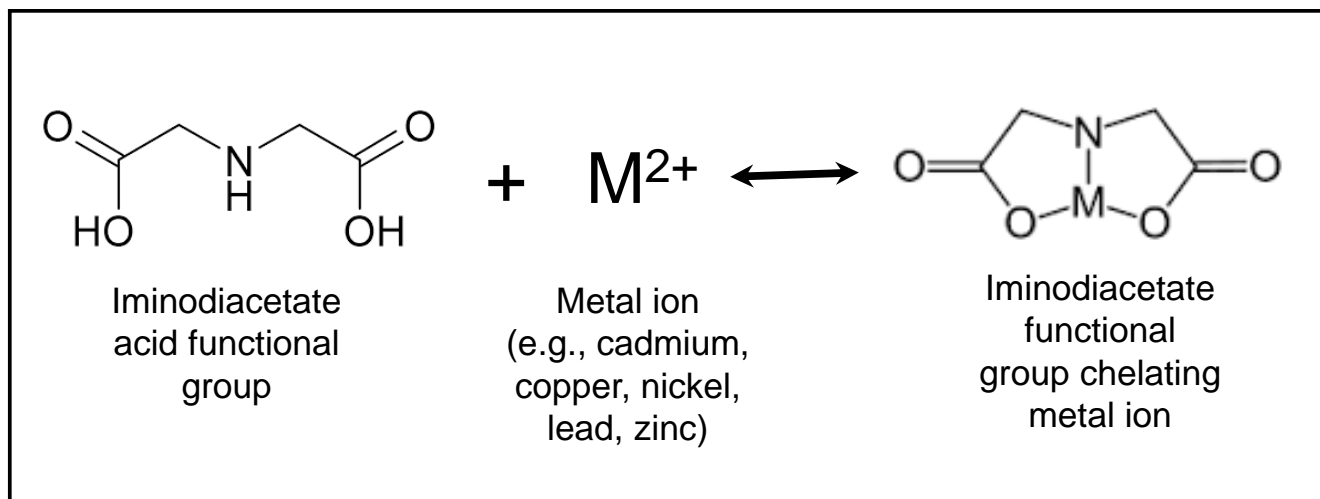
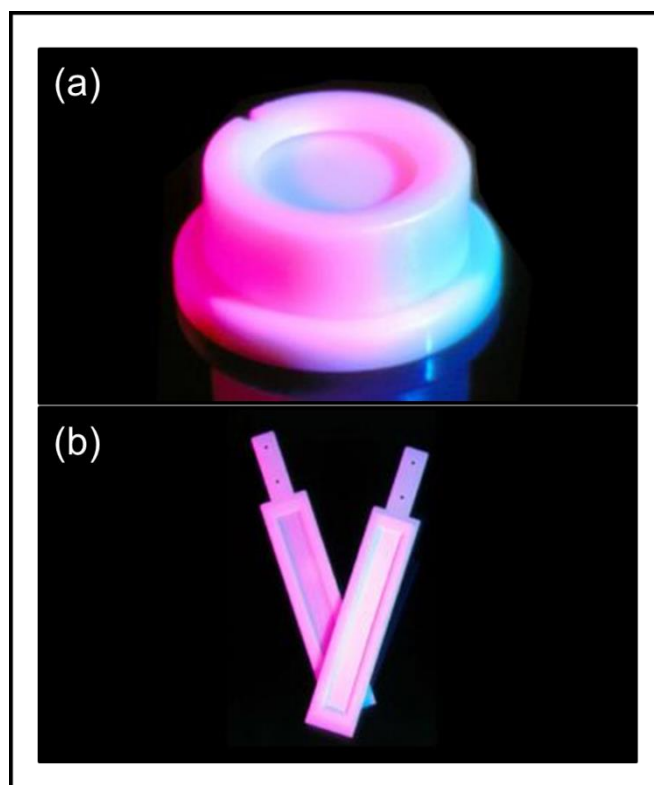

Figure 1-2. Images of passive samplers discussed in this document: (a) low density polyethylene (LDPE)), (b) polyoxymethylene (POM), and (c) polydimethylsiloxane (PDMS). Note: PDMS is shown in a SPME fiber configuration.



**Figure 1-3.** Molecular structures of the iminodiacetate acid functional group interacting with a metal ion to form the chelated configuration of the iminodiacetate and metal groups. The letters H, O and N represent hydrogen, oxygen and nitrogen atoms, respectively.



**Figure 1-4.** Images of two common configurations of DGT passive samplers: (a) disk (2.5 cm diameter) and (b) sediment probe (approximately 4 cm wide by 24 cm long) (images from the DGT Research Ltd. website).

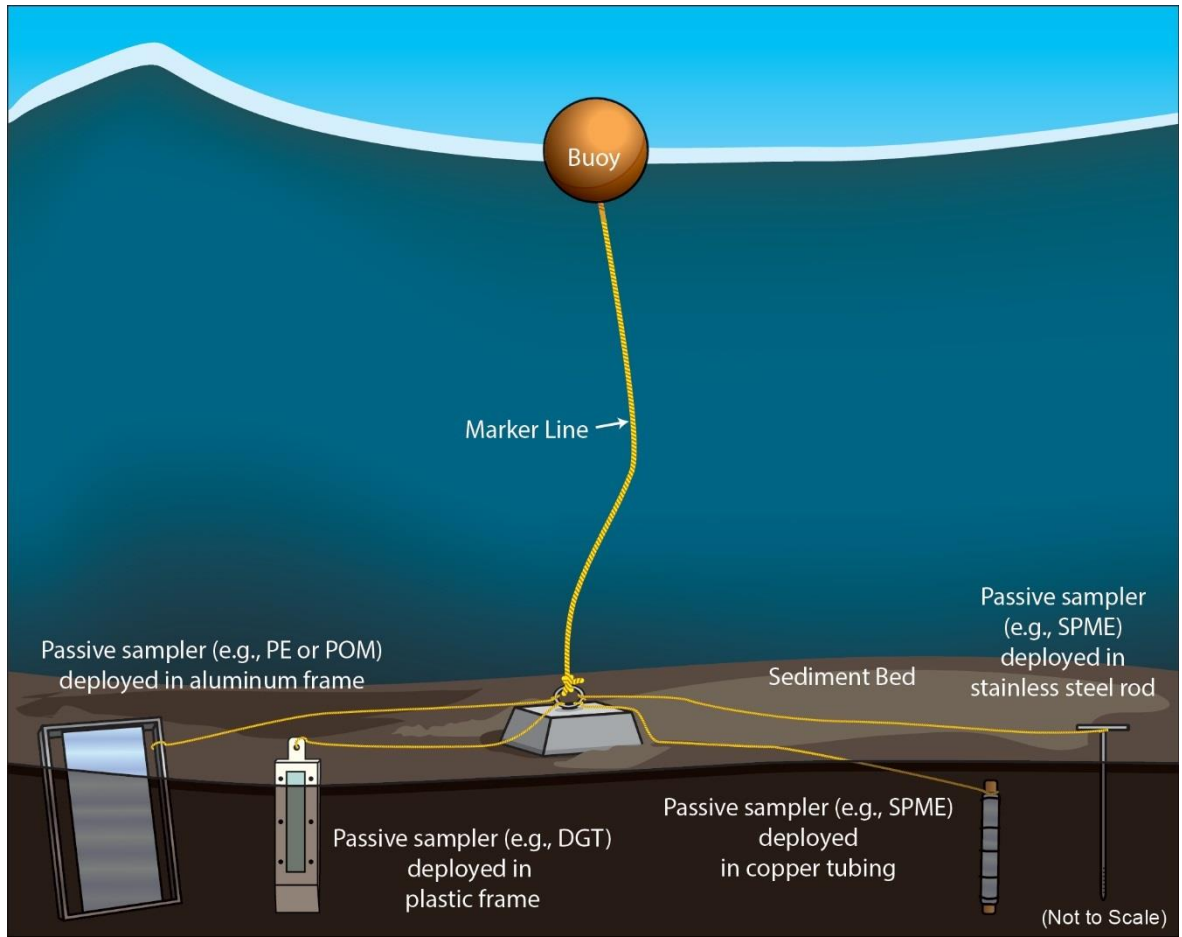

**Figure 1-5. Illustration of different deployment configurations for the passive samplers discussed in this document (based on U.S. EPA 2012b). Deployment configurations are discussed in Sections 2, 3, 4 and 5. Note that in areas where vandalism is a concern, rather than using surface buoys to mark passive samplers, lines can be returned to shore or the application of subsurface buoys may be considered.**

## 1.4 Principles of the Passive Sampling of Target Hydrophobic Organic Contaminants

Passive sampling is based on the thermodynamically regulated exchange of chemical between the environmental medium that is being investigated, and the passive sampling polymer that accumulates the target contaminant via diffusion. This can be approximately described by a first-order kinetics model:

$$\frac{dC_{PS}}{dt} = k_e (C_{PS}^{non-eq} - C_{PS})$$

(during kinetic uptake) [1-1]

and

$$C_{PS} = K_{PS} * C_{free} \text{ (at equilibrium)} \quad [1-2]$$

where,  $C_{PS}$  is the target contaminant concentrations in the sampler ( $\mu\text{g/g}$  passive sampler) at time  $t$  or at equilibrium;  $k_e$  is the exchange-rate coefficient ( $1/\text{d}$ ) for the target contaminant under the conditions of interest;  $C_{PS}^{non-eq}$  is the non-equilibrium passive sampler concentration ( $\mu\text{g/g}$  passive sampler), and  $K_{PS}$  is the partition coefficient of the target contaminant between the polymer and water ( $\text{mL water/g passive sampler}$ ) (Bayen et al. 2009). For the purposes of this document, Equation 1-2 can be modified to the following to calculate  $C_{free}$  ( $\mu\text{g/mL}$ ):

$$C_{free} = \frac{C_{PS}}{K_{PS}} \quad [1-3]$$

to solve for the  $C_{free}$  concentration. As discussed later in this document, with proper application of passive sampling,  $C_{PS}$  will be measured analytically or estimated, and  $K_{PS}$  values are available in this document and the scientific literature for POM, PDMS, and LDPE.

As shown above, passive sampling can be implemented in two different operational modes: equilibrium and kinetic (or non-equilibrium) (Figure 1-6). Under the equilibrium mode, sufficient time is allowed for the target contaminant to reach equilibrium with the sediment, the passive sampler, and the other environmental phases (Mayer et al. 2000; Mayer et al. 2003). Once the passive sampler is at equilibrium,  $C_{free}$  can be calculated using Equation 1-3 from the measured concentration in the passive sampler and partition coefficients obtained from this document and/or the scientific literature. In the kinetic mode, calculation of the non-equilibrium concentration of the target contaminants in the passive sampler ( $C_{PS}^{non-eq}$ ) will underestimate actual dissolved concentrations ( $C_{free}$ ) and result in errors in any environmental management decisions. Section 8 discusses how  $C_{free}$  can be calculated properly under non-equilibrium conditions (Huckins et al. 2002; Tomaszewski and Luthy 2008; Fernandez et al. 2009a; Perron et al. 2013a,b; Tcaciuc et al., 2014).

It is important to understand when the target contaminant reaches equilibrium with the passive sampler, sediments, and other environmental media, and how rapidly equilibrium is achieved. This kinetic state depends on exposure time, passive sampler characteristics such as construction material, thickness, and dimensions, and the target contaminant's physicochemical properties (Mayer et al. 2003; Vrana et al. 2005; Apell et al., 2015). In general, the time to equilibrium increases with increasing polymer thickness and  $K_{PS}$  values, and decreases with increasing polymer diffusivity, ratio of surface area to volume, agitation, temperature, and mass ratio of sediment to polymer. Analytical detection limits can be lowered by using polymers of large areal size while maintaining the same thickness. Thus, the optimum condition for the sampler (e.g., polymer type, size, shape, thickness) should be determined to achieve reasonable equilibrium time while not losing

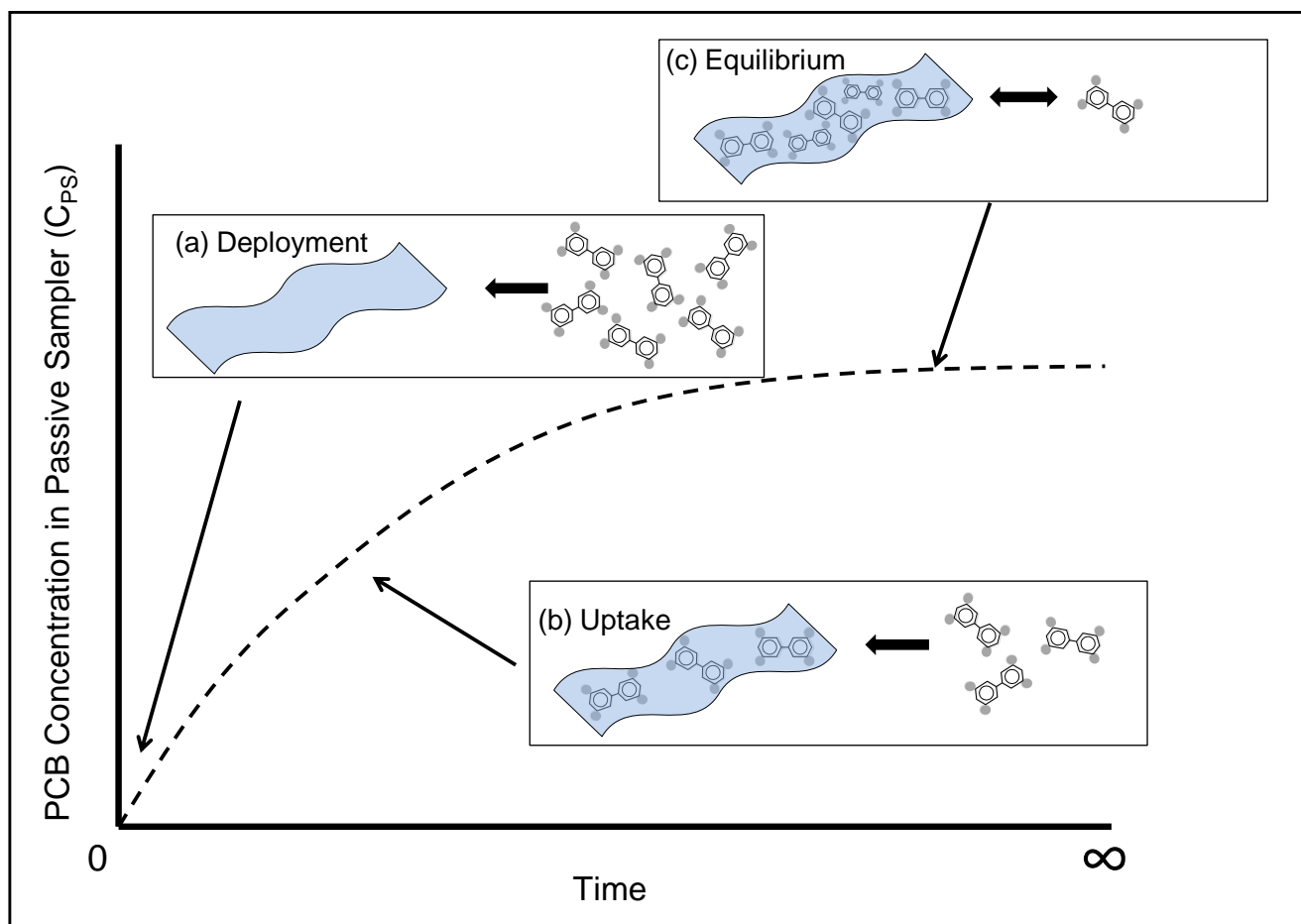

**Figure 1-6. Cartoon showing the three stages of passive sampler operation: (a) deployment, (b) uptake (or kinetic), and (c) equilibrium. The blue forms represent passive samplers, and the small icons are PCB molecules (from U.S. EPA 2012b).**

the sensitivity to detect potentially lower concentrations of the target contaminants.

Successful implementation of passive sampling under equilibrium conditions is subject to the following requirements. Equilibrium should be reached among different phases present—the passive sampler and other environmental phases in the multiphasic environment (sediment particles, colloids, organisms). However, equilibrium is achieved particularly slowly for strongly hydrophobic compounds (e.g.,  $\log K_{ow} > 6$ ). While not always the case, many currently available passive samplers require weeks to months and even years to reach equilibrium for high  $K_{ow}$  target contaminants (Gschwend et al. 2011;

Mayer et al. 2000; Apell and Gschwend 2014). In contrast, low  $\log K_{ow}$  contaminants (i.e.,  $< 4$ ) will reach equilibrium more rapidly. In general, because of its thinner thickness, the PDMS coating SPME fibers will achieve equilibrium in *in situ* sediment exposures with target contaminants relatively rapidly (i.e., days to weeks). By comparison, the thicker POM and LDPE will require more time for target contaminants to achieve equilibrium (i.e., weeks to months). In addition, elevated variability can occur for high  $K_{ow}$  target contaminants, especially in field applications (*in situ*) where control over experimental conditions is not as feasible as in the laboratory (*ex situ*). Second, the amount of the chemical transferred into the sampler in the laboratory



(i.e., *ex situ*) should be negligible relative to the sediment system and should not impose significant disturbance or depletion on the equilibrium condition between the other environmental phases. This is commonly referred to as “non-depletive” conditions, and typically, less than 1% of depletion of the chemical in the sediment system by the passive sampler is considered acceptable (Jonker and Koelmans 2001; Mayer et al. 2003; Ghosh et al. 2014).

### 1.5 Principles of the Passive Sampling of Metals

Heavy metals (e.g., Cd, Cu, Ni, Pb, Zn) are some of the most common pollutants found in sediment in freshwater, estuarine, and marine environments. At elevated concentrations, metals can have adverse effects on aquatic biota (and in rare cases, on human health), which has led to the regulation of metal-containing discharges, efforts to clean up contaminated sediments, and an increasing emphasis placed on metals risk assessment. Through decades of research on sediment metals, one of the fundamental conclusions is that a measurement of the entire pool of metal at a location (i.e., total metals) is not an effective predictor of adverse ecological effects (Pagenkopf 1983; Ankley et al. 1996; U.S. EPA 2005b). Due to their reactivity, metals can bind with and adsorb to many chemical species (i.e., form complexes), and complexed metals in general, are less bioavailable and, therefore, toxic than freely dissolved metals. The physicochemical complexity of the sediment environment provides many binding ligands for metals. Attempting to set regulatory criteria or clean-up goals based on a total metal threshold ignores the potential for non-bioavailable pools of metal and can result in unnecessarily low regulatory criteria.

The concept of bioavailable metals has been used to define the fraction of metal that has the potential to interact with biota, which excludes complexed (i.e., non-toxic) metals

that would be measured in the total metal fraction (Ankley et al. 1996; Meyer 2002; U.S. EPA 2005b). The goal of estimating bioavailability is to more accurately reflect metal exposure and potential effects, and ultimately, to provide a method of measuring metals that can standardize exposure to a wide range of sedimentary conditions. In surface waters, the biotic ligand model (BLM) has been used successfully to account for the binding of some metals by dissolved organic carbon (DOC) and competition at the site of biotic action by other cations (e.g.,  $Mg^{2+}$ ,  $H^+$ ) (Di Toro et al. 2001), which has allowed comparison of the effects of metals across a wide range of surface water chemistries (Santore et al. 2001). In sediments, the primary metal complexation processes occur in the solid phase, with reduced sulfur (e.g., CuS), organic carbon, and iron oxides all reducing the bioavailable pool of metal (Ankley et al. 1996; U.S. EPA 2005b; Burton 2010). Although much of the metal binding occurs in the solid phase, the pool of bioavailable metal in sediments is largely dissolved in the interstitial water (see previous discussion of AVS).

Like the HOCs, an alternative approach for estimating bioavailable metals is the use of passive sampling, which unlike equilibrium partitioning modeling for HOCs, attempts to measure bioavailable metals directly, without having to measure metal concentrations in the solid phases. For metals in sediment, a few different designs have been fabricated for use as passive samplers. Interstitial water peepers are the most basic conventional passive samplers and have been used to accurately measure interstitial water metals (Carignan et al. 1985; Brumbaugh et al. 2007). However, peepers can disrupt the sediment structure when installed *in situ*; may take a long time (days to weeks) to equilibrate, and sample all dissolved species even if they are not bioavailable (e.g., dissolved organic carbon [DOC] bound metals). In addition, teflon sheets have been used in sediments to selectively sample iron and manganese oxyhydroxides and

sorbed metals (Belzile et al. 1989; Feyte et al. 2010). Teflon sheets need to be deployed for an extended time period (weeks) to accumulate sufficient Fe, Mn, and trace metals.

Importantly, trace metals bound to Fe and Mn oxyhydroxides are likely not bioavailable; thus, Teflon sheets do not sample a bioavailable fraction of metal. Senn et al. (2004) and Dong et al. (2015) described a sampler that uses the cation exchange resin iminodiacetate suspended in a diffusive gel to accumulate metals. However, the most commonly used passive samplers for metals in sediment are diffusive gradients in thin films (DGTs) (Davison and Zhang 1994; Zhang et al. 1995; Harper et al. 1998). DGTs cause relatively little sediment disturbance at deployment and need only hours to accumulate enough metals to meet analytical requirements. The link between DGT-measured metals ( $C_{DGT}$ ) and bioavailable metals ( $C_{free}$ ) has not been demonstrated definitively (see below), but this technique provides great promise for passively sampling metals and estimating bioavailable metals compared to other approaches.

DGTs for sediments are composed of two functional layers of material that are stacked and exposed to the sediment (see Figure 5-1). The outer layer (direct contact with sediment) is a membrane filter to allow only operationally defined dissolved species to interact with the gels within the DGT. Below the filter is a diffusion gel (polyacrylamide) of a known thickness through which the metals diffuse at a known rate. Below the diffusion gel is an iminodiacetate-based resin gel (Chelex-impregnated polyacrylamide) which binds any dissolved metal that passes through the diffusion gel. The three materials are secured together in a plastic housing, and when inserted into the sediment, rapidly begin to accumulate any metals dissolved in the interstitial water. Because the resin gel is actively and rapidly accumulating metals, concentrations above analytical thresholds can typically be achieved after a short deployment time (<24 hr). The pore size of both the filter and the acrylamide

hydrogel effectively exclude any particulate metals and colloidal metals, yet some DOC-bound metals can be incidentally sampled by the DGT (Davison and Zhang 1994; Zhang 2004; Warnken et al. 2008). Metal dynamics and kinetics in DGT for both aqueous and sediment exposures are described comprehensively in Harper et al. (1998) and Davison and Zhang (1994), and herein, we briefly summarize those papers.

For standard exposure times (hours to days), the resin gel acts as an infinite sink for metals, which establishes a linear diffusion gradient through the diffusion gel (see Figure 5-2). Diffusion kinetics in the gel are well described (Davison and Zhang 1994, Harper et al. 1998) and a concentration at the surface of the DGT ( $C_{DGT}$ ) can be calculated from the mass of metal bound to the resin gel (see Equation 8-5). In simple systems (e.g., well-stirred solutions, well-mixed surface waters),  $C_{DGT}$  is equivalent to the concentration in the solution. However, DGT dynamics in sediments are complicated by interstitial waters that are not well mixed and by large pools of solid-phase metals. Because interstitial waters are not well mixed, the immediate area around the DGT can quickly become depleted of metals, and the diffusion gradient can extend into the sediment. However, interstitial water metals are in equilibrium with metals sorbed to solid-phase fractions, and this decline in interstitial water metal concentrations may cause metal release from solid phases to maintain equilibrium conditions (i.e., resupply) and reduce depletion. If the pool of solid-phase metals is large enough, and the rate of resupply is rapid relative to diffusion and binding in the DGT,  $C_{DGT}$  would still equal interstitial water metal concentrations. The ratio of  $C_{DGT}$  to interstitial water metals concentrations ( $C_{ITW}$ , measured by conventional methods (e.g., centrifugation)) can be calculated ( $R_{DGT} = C_{DGT}/C_{ITW}$ ), and values lower than one are common in sediments (Harper et al. 1998). The value of  $R_{DGT}$  is related to parameters associated with interstitial water diffusion (i.e.,

porosity, tortuosity,  $C_{ITW}$ ) and resupply kinetics (i.e., solid-phase metal concentrations, equilibrium partitioning [ $K_d$ ], rate of desorption). Given sufficient information about sediment and interstitial water physico-chemistry, one can parameterize a model that estimates contributions from the solid phase and interstitial water (Harper et al. 1998; Sochaczewski et al. 2007).

## 1.6 Applications

### 1.6.1 Hydrophobic Organic Contaminants

Passive samplers provide at least two types of information: (1) the freely dissolved concentration ( $C_{free}$ ) and (2) the actual concentration in the sampler. Numerous studies have successfully measured  $C_{free}$  of HOCs in sediments using the passive sampling method (PSM) in both laboratory and field studies (Fernandez et al. 2009b, 2014; Kraaij et al. 2002; Friedman et al. 2009; Maruya et al. 2009; Mayer et al. 2000; ter Laak et al. 2006; Vinturella et al. 2004; Witt et al. 2009). The measurements obtained can provide a great deal of useful information. For example, vertical profiles of contaminant interstitial water concentrations measured at sediment capping or remedial amendment treatment sites can be used as an indicator of remedy effectiveness (Lampert et al. 2011; Oen et al. 2011; Fernandez et al. 2014).

Because passive samplers are intended to measure the chemical activity of contaminants in sediment, it is appropriate to expand their use for evaluating the exposure of organisms to the sediment, usually expressed in terms of bioaccumulation, and any resulting adverse ecological effects. The fact that passive samplers measure  $C_{free}$ , which can serve as a surrogate estimate of exposure, supports the application of passive sampler-based bioaccumulation assessment. However, this approach may have some limitations; it cannot capture all of the processes affecting bioaccumulation, such as contaminant

biotransformation and trophic transfer. Despite these limitations, passive samplers are expected to deliver proportional accumulation of contaminants to the observed bioaccumulation in organisms. Further, these relationships between passive sampler accumulation and bioaccumulation are expected to be statistically significant and predictive. For example, Van der Heijden and Jonker (2009) assessed the bioaccumulation of PAHs using both POM and PDMS for a sediment-dwelling freshwater oligochaete (*Lumbriculus variegatus*). They reported positive correlations between the field-measured bioaccumulation in *L. variegatus* and the predicted bioaccumulation based on  $C_{free}$ . Later, SPME was employed in a similar study and was found to provide reliable bioaccumulation assessments (Muijs and Jonker 2012). Recently, Joyce et al. (2016) reviewed the relationship between passive sampler uptake and organism bioaccumulation.

A simple way to assess toxicity via passive sampling is to compare  $C_{free}$  with water-only toxicity values (i.e., Final Chronic Values (FCVs)) from the U.S. EPA's water quality criteria or other similar water quality guidelines (Maruya et al. 2012; Burgess et al. 2013). Toxicity can also be predicted from a toxicity model using  $C_{free}$  data. For example, Hawthorne et al. (2007) demonstrated that the survival of a freshwater amphipod, *Hyalella azteca*, and toxicity could be predicted based on PAH interstitial water  $C_{free}$  measured by SPME in sediments collected from former manufactured gas production (MGP) and aluminum smelter sites.

Numerous passive sampler studies have provided valuable information regarding measuring  $C_{free}$ . To date, several studies have shown passive sampler accumulation is proportional and predictive of bioavailability, bioaccumulation, and toxicity to contaminants in sediment. Further, studies that compare and evaluate the overall performances of different types of passive samplers are increasing in numbers (Barthe et al. 2008; Jonker and Van

der Heijden 2007; Muijs and Jonker 2011; Van der Heijden and Jonker 2009; Gschwend et al. 2011; Fernandez et al. 2012, 2014; Perron et al. 2013a,b).

#### 1.6.1.1 Application at Superfund Sites

Table 1-2 provides a tabulation of recent applications of passive samplers at U.S. EPA Superfund sites where organic contaminants are the contaminants of concerns (COCs).

Applications include COC source identification, assessing remedy effectiveness, monitoring cap performance, evaluating COC transport, and developing dose-response relationships between target contaminants and local and deployed organisms. In some cases, passive samplers are being evaluated as possible surrogates for biomonitoring organisms. Passive samplers have the advantage of being deployable in environments where organisms may not tolerate the conditions (e.g., low dissolved oxygen, elevated temperatures, toxicity); whereas, passive samplers are not effected by those environmental variables.

#### 1.6.2 Metals

The utility of DGTs comes from their potential use as a selective sampler for bioavailable metal concentrations, and many studies have assessed how DGT measured metal is related to bioavailable metals. For dissolved metals in surface waters, DGTs do provide some capability to differentiate bioavailable metals, but do not completely control for dissolved organic carbon (DOC) bound metals, which are not bioavailable but are sampled by DGTs (Zhang 2004; van der Veeken et al. 2010; Uribe et al. 2011). These DOC-metal complexes can be accounted for by adjusting the thickness or pore-size of the gel (Tusseau-Vuillemin et al. 2004; Warnken et al. 2008). In soils, there is strong evidence that DGT-measured metals do approximate bioavailable metals for plants (Zhang et al.

2001; Degryse et al. 2009; Soriano-Disla et al. 2010). The close approximation of metals bioavailable to plants and DGT-measured metal is not surprising, because root uptake by plants often generates diffusion gradients similar to those created by DGTs (Zhang et al. 2001).

In sediments, there is growing evidence that DGT-measured metal is a valid indicator of bioavailable metal. Roulier et al. (2008) found that, for the freshwater insect *Chironomus riparius*, bioaccumulation of Cu, Cd, and Pb is better predicted by total metals than DGT measured metal, presumably due to dietary exposure to metals. Van der Geest and León Paumen (2008) showed that DGT-measured metal predicted *Tubifex sp.* Cu accumulation, but only for the first three weeks of a 10-week experiment. Simpson et al. (2012) found a strong connection between DGT measured metal and bioaccumulation of Cu by the bivalve *Tellina deltoidalis*, but much of the exposure was from Cu in overlying water, not sediment Cu. Dabrin et al. (2012) found that DGT measured Cd accurately predicted bioavailability for just one of three species tested. Finally, Costello et al. (2012) found that DGT measured Ni over-estimated bioavailability to colonizing benthic macroinvertebrates. Importantly, for many of the studies assessing ecological effects (Dabrin et al. 2012; Simpson et al. 2012; Costello et al. 2012) and other studies looking at sediment geochemistry (Naylor et al. 2004; Tankere-Muller et al. 2007; Roulier et al. 2010), DGT measured metals provided valuable information on metal speciation, distribution, and flux that is important for quantifying exposure and, more specifically, bioavailable concentrations. Therefore, DGTs are a valuable tool in sediment metal risk assessment, but more research needs to be conducted before a strong link between any DGT-related measurements and bioavailable metals can be established. Case study 5 in Appendix F provides an example of the use of DGT at a contaminated sediment site.

Finally, existing on-line tools like the United States Navy's ISRAP provide useful information on selecting monitoring tools for contaminated sediment sites. Using ISRAP along with the information in this document can provide a firm basis for applying passive sampling at contaminated sediment sites.

### 1.7 Additional Passive Sampler Needs and Current Resources

In the process of compiling this document, efforts were made to be as comprehensive as possible and include as much information as was available. However, the science and practice of passive sampling is an evolving process, and some data simply were not available at the time this document was being prepared. For example, this document provides partition coefficients for the partitioning of PCBs and PAHs between the organic polymers discussed here (i.e.,  $K_{POM}$ ,  $K_{PDMS}$ ,  $K_{LDPE}$ ) and water that were published as part of the proceedings from a 2012 SETAC Pellston workshop on passive samplers (Ghosh et al., 2014). Values for chlorinated pesticides, such as the DDTs, and chlorinated dibenzodioxins and furans were not provided in the workshop publication and consequently are not included in any detail in this document. A discussion of partition coefficients for these target contaminants is included in Appendix B.

Another evolving area for passive sampling relates to the selection of the approach used for calculating the  $C_{free}$  concentration for the target organic contaminants. As discussed in Section 8, in one approach, equilibrium is assumed to have been achieved between the target contaminants and environmental phases (e.g., water, particulates, colloids), and  $C_{free}$  is calculated using a  $K_{PS}$ . In a second approach, if equilibrium is not assumed, performance reference compounds (PRCs) are used to adjust the non-equilibrium passive sampler concentration ( $C_{PS}^{non-eq}$ ) data for equilibrium conditions (see Section 8 for a discussion of equilibrium and non-equilibrium conditions).

Section 8 provides links, maintained by the U.S. EPA's Superfund Program and SERDP/ESTCP, to graphic user interface (GUI) programs, called PRC correction calculators (PCC), that will provide calculated adjustment factors (i.e., fractional equilibrium ( $f_{eq}$ ) values) for measured target PCB and PAH concentration data to allow for relatively straightforward and consistent calculations of equilibrium  $C_{free}$  values. The PCCs are operational for the LDPE and PDMS polymers. Efforts continue to expand the PCC's capabilities to include the POM polymer. As new improvements become readily available, such as partition coefficients and PCCs discussed above, as well as others, this document will be updated in future versions.

Below are tables that provide information and resources for passive sampler users. Table 1-3 lists the advantages and disadvantages of various samplers for organic contaminants. Table 1-4 lists academic and governmental technical contacts with expertise and experience working with various aspects of passive sampling. They can be contacted to answer technical questions about passive sampling or point any requests in the right direction for a timely resolution. This document cannot address all of the possible scenarios that may occur when applying passive sampling (e.g., heterogeneity in contaminant distributions, implications of varying temperatures and salinities during deployments, development of statistical designs for sampling, and impacts of groundwater intrusions) but the experts listed in Table 1-4 can provide advanced guidance. In addition, Table 1-5 lists commercial analytical laboratories that, at the time of this document's release, have experience with the chemical analysis aspects of passive sampling. These two tables are intended to encourage potential passive sampler users to apply the technology at contaminated sites and contact any of the people listed for guidance or analytical services.

In several places in this document, the use of divers is recommended for the deployment and recovery of passive samplers. Given the types of aquatic environments in which passive samplers are deployed (i.e., contaminated sites), the diver's health and safety must be considered. However, comprehensive coverage of diver health and safety concerns during the deployment and recovery of passive samplers in contaminated waters and sediments are beyond the scope of this guidance. Please contact the U.S. EPA's Environmental Response Team (<https://www.epa.gov/ert/forms/contact-us-about-environmental-response-team-ert>) and/or Region 10's dive unit expertise centers (<https://yosemite.epa.gov/r10/OEA.NSF/investigations/dive+team>) in order to receive more information on polluted water diving.

## 1.8 Commercial Laboratory Considerations

### 1.8.1 Use of Project Teams

For commercial laboratories, the use of passive sampling at contaminated sediment sites is an emerging technology with some research attributes. The addition of passive sampler analysis to a commercial laboratories portfolio will likely include some new costs summarized in Table 1-6. Note, Table 1-6 is likely to be incomplete at this time. To successfully implement passive sampler application at commercial laboratories may require a collaborative working relationship with a research laboratory (e.g., governmental, academic) in order develop an approach to support these projects and make the best decisions related to all of the considerations related to the sample preparation, sample handling and subsequent analysis and data reporting. This collaboration could represent a 'project team'. To enhance the operation of the project team, especially when a commercial laboratory first starts to perform passive sampling-related work, the development of a detailed project specification/statement of work

for a given passive sampling project is recommended. This document would include a conceptual site model for the site and would discuss the project's objectives and goals. With such documentation, the commercial laboratory would be in a better position to contribute to the project team. The project specification/statement of work would incorporate sections that are non-standard to most commercial laboratories (i.e., not "off the shelf content") including:

**Project goals** – Developed with the project team based on their goals

**Media** – Discuss acquisition and handling, *in situ* versus *ex situ* deployment, including choices of passive sampler media (e.g., POM, PDMS, LDPE), fabricating media for deployments, and the use of performance reference compounds (PRCs)

**Deployment and retrieval of passive samplers** – Develop plan for handling of the media to get it to the contaminated site and associated QA/QC

**Defining "Immediately"** – See the discussion below in Section 1.8.3.

**Data Analyses** – Determine how the data will be analyzed. Specifically, in order to calculate  $C_{free}$ , the organic target contaminants must be expressed as individual target contaminants; for example, for PCBs, data must be reported in terms of individual congeners not Aroclors or homologs

**Data Reporting** – Establish terms for reporting findings

From the laboratory perspective, these are the areas which need to be clear and discussed to appropriately execute the project and transition this support from project teams within a research setting to a commercial laboratory.

One role of the project team members may be, especially early in the process of adopting passive sampling technology, to select the optimum passive sampling polymer and deployment configuration for a given contaminated sediment site.

### 1.8.2 *Role of this Document's Methods*

The methods in this document, particularly the analytical methods (Section 7), are not intended to supersede the standard operating procedures (SOPs) of commercial laboratories nor are they meant to become the SOPs for commercial laboratories. The methods presented here are simply intended to provide guidance to commercial laboratories in the development of their own SOPs. For example, commercial laboratories may use different organic solvent systems than are discussed here as long as those solvents generate acceptable extraction recoveries for the polymers. Further, the discussion of the specific passive samplers in Sections 2, 3, 4 and 5 are not intended to replace existing commercial laboratory SOPs for a given passive sampler but provide guidance for the development and improvement of those SOPs.

### 1.8.3 *Defining "Immediately" in this Document*

In several parts of this document, the terms "immediate" and "immediately" are used relative to the handling of the passive samplers. It is recognized that commercial laboratories are often required to use holding times which define how long samples can be held before processing and analysis must be performed (e.g., several U.S. EPA methods use 14 days). In contrast, when used relative to passive samplers, the term "immediate" is, frequently, a recommendation to process the sampler as soon as possible after removal from the deployment system (e.g., field sediments) to avoid loss of low molecular weight target contaminants like naphthalene. This consideration is particularly important when using PDMS in the form of

SPME fibers (Section 3) as low molecular weight target contaminants will rapidly transfer from the fiber into the air phase (e.g., volatilize). When low molecular weight target contaminants are included as target contaminants in a given project, the Project Team should insure that passive samplers are processed as quickly as possible. This will often mean simply adding a volume of organic solvent to a recently retrieved passive sampler in a clean laboratory vial. Following the addition of the solvent, the vial can be capped and stored until the extraction and instrumental analysis can be completed. In this document, the addition of solvent to passive samplers shortly after retrieval is called "processing".

### 1.8.4 *Availability of Passive Sampler Partition Coefficients*

In general, commercial laboratories are not expected to generate  $K_{PS}$  values unless specifically requested. For the most common target contaminants (e.g., PCBs, PAHs, DDTs, dioxins/furans),  $K_{PS}$  values are provided or discussed in the document (see Sections 2.7, 3.7, and 4.7, and Appendices A and B). In cases where a  $K_{PS}$  is not available for a given target contaminant, the commercial laboratory is recommended to contact a research facility for a value. Section 2.8 discusses the general approach for generating an empirical  $K_{PS}$ , in this case for  $K_{POM}$ , but this section is intended to be primarily informational and not prescriptive. Table 1-4 can be consulted for academic and governmental experts to consider contacting for the generation of a  $K_{PS}$  value(s).

**Table 1-2. Application of passive samplers at selected U.S. EPA Superfund sites where the target contaminants of concern (COCs) are organic contaminants**

<b>Site</b>	<b>U.S. EPA Region</b>	<b>Application</b>
Aniston PCB	4	Develop a dose-response curve for benthic toxicity studies
Berry's Creek	2	Monitor remedy effectiveness of activated carbon (AC) application in a pilot study
Brodhead Creek	3	Monitor transport of contaminants from ground water into interstitial water (not deployed yet)
Diamond Alkali	2	Monitor cap effectiveness; develop dose-response curve for benthic toxicity studies
Grand Calumet	5	Monitor cap effectiveness
Grasse River	2	Monitor transport of contaminants from sediment into water column; Compare passive sampler accumulation to bioaccumulation
Lake Hartwell	4	Monitor PCB diffusion from surficial sediment into overlying surface water
Lower Duwamish Waterway	10	Identify sources of contaminants to water column and organisms; Monitor pilot study of activated carbon application effectiveness
MW Manufacturing	3	Monitor volatile organic contaminant discharges from groundwater into stream
Naval Station Newport	1	Research and development on performance of passive sampling methods
New Bedford Harbor	1	Research and development on performance of passive sampling methods
Pacific Sound Resources	10	Assess groundwater breakthrough of a sediment cap via measurement of interstitial water
Palos Verdes Shelf	9	Monitor transport of contaminants from sediment into water column; remedy effectiveness
Tennessee Products	4	Monitor creosote/non-aqueous phase liquid (NAPL) isolation (and potential break thru) below a AquaBlok cap
United Heckathorn	9	Identify sources of contaminants to water column and organisms
Wyckoff	10	Monitor cap; Assess remedy effectiveness



**Table 1-3. Advantages and disadvantages of different types of passive samplers for target organic contaminants.**

Passive Sampler	Advantages	Disadvantages
Low density polyethylene	Inexpensive polymer Robust and rugged Easy to work with Simple to deploy and recover Not limited by sample mass (greater analytical sensitivity) Will stretch during deployment before it rips Increasing use globally Good for both water column and sediment deployments	Slower equilibration than PDMS Folds on itself, making cleaning difficult
Polyoxymethylene	Inexpensive polymer Robust and rugged Easy to work with Simple to deploy and recover Not limited by sample mass (greater analytical sensitivity) Cleans easily Increasing use globally Good for both water column and sediment deployments	Slower equilibration than PDMS Can rip easily compared with LDPE
Polydimethylsiloxane	Inexpensive polymer fibers Rapid equilibrium Widely used globally Once protected, simple to deploy and recover Cleans easily Good for sediment deployments	Fragile – need to protect during deployment Relatively difficult to handle Limited polymer mass (less analytical sensitivity) Poor for water column deployments because of the limited polymer mass

**Table 1-4. List of academic and governmental technical contacts with expertise and experience working with passive samplers. This tabulation is not exhaustive and is provided as a starting point for acquiring expert guidance on passive sampling.**

Name	Passive Sampler Application	Affiliation and e-mail
Robert Burgess	POM and LDPE water column and sediments deployments; Performance of different passive samplers; Use of performance reference compounds; Relationship to organism bioaccumulation	U.S. EPA burgess.robert@epa.gov
Lawrence Burkhard	PDMS sediment deployment; Relationship to organism bioaccumulation	U.S. EPA burkhard.lawrence@epa.gov
G Allen Burton	Sediment DGT deployments	University of Michigan burtonal@umich.edu
Mark Cantwell	LDPE water column deployments in riverine systems	U.S. EPA cantwell.mark@epa.gov
William Davison	DGT design and application	Lancaster University w.davison@lancaster.ac.uk
Loretta Fernandez	POM and LDPE water column and sediments deployments; Performance of different passive samplers; Use of performance reference compounds; Relationship to organism bioaccumulation	Northeastern University Fernandez, Loretta l.fernandez@neu.edu
Upal Ghosh	POM water column and sediments deployments; Relationship to organism bioaccumulation	University of Maryland – Baltimore County ughosh@umbc.edu
Philip Gschwend	LDPE water column and sediments deployments; Performance of different passive samplers; Use of performance reference compounds; Relationship to organism bioaccumulation	Massachusetts Institute of Technology pmsgschwe@mit.edu
Marc Greenberg	Use of passive sampler information for decision making	U.S. EPA greenberg.marc@epa.gov
Steve Hawthorne	PDMS sediment deployments; Relationships to toxicity and bioaccumulation	University of North Dakota Hawthorne, Steven SHawthorne@undeerc.org
Judy Huang	RPM for Palos Verdes Shelf site deploying passive samplers	U.S. EPA huang.judy@epa.gov
Abbey Joyce	POM, PDMS and LDPE water column and sediments deployments; Use of performance reference compounds and data analysis	U.S. EPA joyce.abbey@epa.gov
Susan Kane Driscoll	LDPE water column and sediments deployments; Use of passive sampler information for decision making	Exponent sdriscoll@exponent.com
Matthew Lambert	LDPE sediment deployments; Passive sampler use in baseline and remedy effectiveness monitoring	U.S. EPA lambert.matthew@epa.gov

Name	Passive Sampler Application	Affiliation and e-mail
Rainer Lohmann	PDMS and LDPE water column and sediments deployments; Performance of different passive samplers; Use of performance reference compounds	University of Rhode Island lohmann@gso.uri.edu
Keith Maruya	PDMS and LDPE water column and sediments deployments; Use of performance reference compounds; Relationship to organism bioaccumulation	Southern California Coastal Water Research Project Keith Maruya keithm@sccwrp.org
Marc Mills	LDPE water column and sediment deployments; Source tracking and identification; Relationship to organism bioaccumulation	U.S. EPA mills.marc@epa.gov
Monique Perron	LDPE, POM and PDMS water column and sediments deployments; Performance of different passive samplers; Use of performance reference compounds	U.S. EPA perron.monique@epa.gov
Danny Reible	PDME water column and sediments deployments; Relationship to organism bioaccumulation	Texas Technical University danny.reible@ttu.edu
Sean Sheldrake	Passive sampler deployment techniques and diver related QA/QC issues	U.S. EPA sheldrake.sean@epa.gov
Stuart Simpson	DGT application in marine sediments	CISRO stuart.simpson@csiro.au
Rachelle Thompson	RPM for United Heckathorn site deploying passive samplers	U.S. EPA thompson.rachelle@epa.gov

**Table 1-5. Examples of commercial analytical laboratories capable of consulting on and/or performing analyses on passive samplers (as of December 2016). This tabulation is not exhaustive and is provided as a starting point for locating commercial laboratories with passive sampling experience.**

Laboratory	Contact Name and	Location
ALS Environmental	Jeff Christian jeff.christian@alsglobal.com	1317 South 13th Ave Kelso WA 98626 USA
Alpha Analytical	Jim Occhialini jocchialini@alphalab.com	8 Walkup Drive Westborough, MA 01581 USA
AXYS Analytical Services	Georgina Brooks <a href="mailto:gbrooks@axys.com">gbrooks@axys.com</a>  Richard Grace <a href="mailto:rgrace@axys.com">rgrace@axys.com</a>	2045 Mills Road West Sidney, BC V8L 5X2 Canada
Brooksrand Labs	Michelle Briscoe michelle@brooksrand.com	18804 North Creek Parkway Suite 100 Bothell, WA 98011 USA
DGT Research Ltd.	Hao Zhang <a href="mailto:h.zhang@lancaster.ac.uk">h.zhang@lancaster.ac.uk</a>	Skelmorlie, Bay Horse Rd Quernmore, Lancaster Lancashire, LA2 0QJ United Kingdom
Frontier Analytical Laboratory	Bradley Silverbush brads@frontieranalytical.com	5172 Hillside Circle El Dorado Hills, CA 95762 USA
Geosyntec	Jason Conder jconder@geosyntec.com	2100 Main Street, Suite 150 Huntington Beach, CA 92648 USA
PACE Analytical Services, Inc.	Mary Christie <a href="mailto:mary.christie@pacelabs.com">mary.christie@pacelabs.com</a>	205 Seagull Dr. Mosinee, WI 54455 USA
Test America	Patricia MacIsaac <a href="mailto:patrica.mcisaac@testamericainc.com">patrica.mcisaac@testamericainc.com</a>  Bruce Wagner Bruce.wagner@testamericainc.com	3452 Lyrac St. Oakton, VA 22124 USA
SiRem	Jeff Roberts jroberts@siremlab.com	130 Stone Road West Guelph, Ontario N1G 3Z2

**Table 1-6. Additional costs for commercial laboratories associated with the deployment and analysis of passive samplers.**

Scope of Activity	Consideration
Labor of Laboratory Project Manager	Additional labor may be necessary, especially early in the process of adopting passive sampling when the technology is unfamiliar.
Purchasing and cleaning passive samplers	New costs.
Purchasing performance reference compounds (PRCs)	New cost which can be expensive for the <sup>13</sup> C-labelled PRCs used for PCBs and DDTs. Use of deuterated PAHs as PRCs for PAH passive sampling is much less expensive than <sup>13</sup> C-labelled PRCs.
Labor associated with amending passive samplers with PRCs and verifying PRC concentrations in passive samplers	New costs.
Additional labor and purchasing associated with passive sampling analytical and QA/QC requirements including passive samplers, deployment, retrieval and field blanks, method blanks, and matrix spikes and duplicates	New costs which will likely evolve as the use of passive sampling becomes more familiar.

## 1.9 Document Overview

This User's Manual has 10 sections and an extensive selection of appendices. Following this Introduction. The first four sections discuss in detail the preparation, deployment, and retrieval of POM, PDMS, LDPE, and DGT passive samplers. The next sections address the use of performance reference compounds (PRCs), the extraction and analysis of passive samplers, data analysis, and quality assurance and quality control. The final section provides an extensive list of the references cited throughout this document. A series of

appendices provides a range of information, including provisional partition coefficients for POM, PDMS, and LDPE, passive sampling case studies, and two examples of passive sampler quality assurance project plans (QAPPs).

Again, the primary goal of this document is to provide the passive sampling user with the information needed to deploy, collect and analyze passive samplers and the resulting data.

## Section 2

# Passive Sampling with Polyoxymethylene (POM)

## 2.1 Introduction

POM is commercially available and can be purchased in bulk, in the form of sheets, thin film (e.g., 76  $\mu\text{m}$ ), beads and blocks. While POM has similar partition coefficients to LDPE for HOCs, this rigid polymer has extremely low diffusivities compared to PE (Ahn et al. 2005; Janssen et al. 2011; Jonker and Koelmans 2001; Rusina et al. 2007). Although low diffusion coefficients in POM correspond to higher partition coefficients, it would require longer equilibration times. To compensate for this longer equilibration time, thinner POM (17 or 55  $\mu\text{m}$  thick) might be used (Cornelissen et al. 2008a,b) but this requires finely cutting the sheets from POM blocks. Currently, these thin sheets are not commonly available. The smoother and harder surface of POM compared to LDPE makes the polymer clean-up easier, reducing the likelihood of biofouling and trapping of particular matter on the sampler surface (Jonker and Koelmans 2001).

When correct procedures are followed in the use of POM in passive sampling applications, the analytical results have high accuracy and reproducibility. Key to the success of any passive sampling approach is the accurate determination of polymer partition coefficient for the target contaminants of interest. A recent report by Arp et al. (2015) reviewed reported results from six studies for PCBs and three studies for PAHs and found that majority of the differences between could be attributed to different thicknesses of POM used (lack of equilibrium) and range of extraction procedures used. They report that when the correct thickness of POM is used

( $\leq 76 \mu\text{m}$ ), and a hexane-acetone mixture is applied for the extraction, the reported  $K_{\text{POM}}$  values for PCBs and PAHs are highly reproducible (i.e., within 0.2 log units). Thus, for POM, it is critical to ensure that the thickness of POM used is 76  $\mu\text{m}$  or less. Also, it is important to use the same POM for laboratory and field deployments as used in the  $K_{\text{POM}}$  determination. The most widely used  $K_{\text{POM}}$  values are for the 76  $\mu\text{m}$  POM from CS Hyde Company which is made with an ethylene oxide copolymer (Table 1-1).

Most of the published studies have reported use of POM in the determination of equilibrium aqueous concentrations (i.e.,  $C_{\text{free}}$ ) in sediments based on *ex situ* laboratory experiments. At the time of this publication, there have been few studies of *in situ* application of POM with performance reference compound (PRC) corrections.

## 2.2 Laboratory Preparation

As noted previously, in the context of passive sampling, deployments in the laboratory are called *ex situ* while deployments in the field are called *in situ*. Passive sampling with POM has been used extensively in the measurement of equilibrium interstitial water  $C_{\text{free}}$  in sediment based on laboratory batch experiments (Hawethorne et al., 2009, 2011, Jonker and Koelmans 2001). In this approach, sediment collected from the field is brought to the laboratory and allowed to contact the passive sampler under well-mixed conditions (e.g., rolling, slurries) to achieve a target

contaminant thermodynamic equilibrium state between the passive sampler and environmental phases (e.g., water, sediments, organisms) (Figure 2-1). Key steps involved in performing *ex situ* laboratory equilibrium experiments with POM are described here.

### 2.2.1 POM Selection and Pre-Cleaning

At this time, the recommended source of POM is the commercially available 76  $\mu\text{m}$  sheets available from CS Hyde Company (Lake Villa, Illinois, USA) (Table 1-1). For *ex situ* deployments, approximately 300 mg strips of POM are prepared for addition to 40 mL laboratory vials (Hawthorne et al., 2009). For *in situ* deployments (see Section 2.3), POM is cut into appropriately sized pieces, typically 2.5-cm-wide strips, 2.5 to 15.2 cm long. For both types of deployments, the POM strips need to be pre-cleaned to remove residual monomers and any target and non-target contaminants. The pre-cleaning involves extraction for 12 hours with Soxhlet with 50:50 acetone/hexane, after which they are dried for 12 hours. Some researchers have also performed triplicate batch extractions with the same solvent combination at room temperature and achieved an acceptable degree of cleaning (Jonker and Koelmans 2001). After cleaning, the POM strips are kept in a clean glass bottle at  $-4^{\circ}\text{C}$ , in the dark, to prevent recontamination from exposure to laboratory air and other sources.

### 2.2.2 Selection of POM: Sediment Ratio

While using a large mass of POM has the advantage of absorbing a greater mass of target contaminant, leading to improved detection limits, the accurate measurement of interstitial water concentrations requires that negligible depletion of the matrix or interstitial water concentration (described as <1% depletion) occurs when equilibrium is reached. For target contaminants, the introduction of a passive sampler will inevitably start depleting the

interstitial water, but desorption of the contaminant from the sediment will replenish the aqueous pool. To avoid depletive extractions, the sediment organic carbon-to-sampler ratio should be sufficiently large, because these are the two primary absorptive pools that compete for sorption of hydrophobic contaminants in a sediment system. As a general rule (assuming that sediment organic carbon and polymer matrices have similar partitioning characteristics), a ratio of 1:100 polymer mass to sediment organic carbon mass should reduce any depletion to an acceptable level of <1%.

If more accurate estimates of chemical-specific organic carbon normalized partition coefficient ( $K_{OC}$ ) (mL waer/g organic carbon) and  $K_{PS}$  values are available, the 1:100 ratio can be refined as:

$$\frac{(M_{PS} * K_{PS})}{(M_{OC} * K_{OC})} = \left( \frac{1}{100} \right) \quad [2-1]$$

where,  $M_{PS}$  is the mass of polymer, and  $M_{OC}$  is the mass of sediment organic carbon. Equation 2-1 can be reworked to solve for the mass of the passive sampler ( $M_{PS}$ ):

$$M_{PS} = 0.001 * M_{OC} * \frac{K_{OC}}{K_{PS}} \quad [2-2]$$

If detection limits and other logistical considerations, such as a lack of prior accurate estimates of  $K_{OC}$  or  $M_{OC}$ , do not allow for maintaining the depletion at <1%, it is possible to correct for the potential depletion as described in Fagervold et al. (2010). Such corrections are feasible when the depletion is still small (<10%) and within the range for which a linear relationship for partitioning characteristics of the sediment organic matter can be assumed. Also, when the goal of the  $C_{free}$  measurements is to assess site-specific native partition coefficients (e.g.,  $K_{OC}$ ), the

decreased matrix concentrations (i.e., post-deployment sediment concentrations) can be measured and accounted for in the partitioning calculation.

### 2.2.3 Selection of Sediment Mass to be used for $C_{free}$ Determinations

Key criteria that are involved in deciding how much sediment mass should be used include the concentration of the target contaminant in the sediment and the analytical detection limits. One approach for performing the calculation is to work backward from the analytical mass detection limits. For example, if the analytical detection limit is X ng/mL for a given target contaminant in the final solvent extract, and the desire is to stay 10 times above the detection limit, one can target a final concentration of 10X ng/mL as the minimum. Assuming a final extract volume of 1 mL, this amounts to a mass of 10X ng target contaminant sampled in the POM. The batch equilibrium experiments are designed such that not more than 1% of the target contaminant is transferred from the sediment into the passive sampler, as described above. Thus, the minimum sediment mass that is required should have 1000X ng of the target contaminant. So, the mass of sediment required will equal  $1000X/C_{sed}$  g, where  $C_{sed}$  [ng/g] is the concentration of the target contaminant in sediment. For most applications, this results in the range of 10–1000 g sediment (wet) per replicate measurement depending on the level of sediment contamination. For example, Hawthorne et al., (2009) used 10 to 15 grams of relatively highly PCB contaminated wet sediment combined with 30 mL of deionized water to perform their *ex situ* sediment-water slurry equilibrations (Figure 2-1). The sediment sample should be homogenized before distributing into at least duplicate samples ( $n = 2$ ) for the measurement of equilibrium interstitial water  $C_{free}$ .

### 2.2.4 Exposure Time and Conditions

A typical exposure time for well-mixed batch experiments with POM is one month. Results reported by Hawthorne et al. (2009) indicate adequate equilibration even for octachlorobiphenyls in that period of time in well-mixed batch systems. While sediment samples with high water content can be used directly to form a slurry, additional water may need to be added to form a free-flowing slurry for most sediments. Typical water content in a well-formed slurry is 80% water (Figure 2-1). Clean DI water can be used to supplement the water content for freshwater sediments. If necessary, water with appropriate salinity can be prepared by adding reconstituted seawater prepared from hypersaline brine or Instant Ocean salt mixture, as performed by Gomez-Eyles et al. (2013). Exposure bottles should be well mixed, typically on a shaker table or bottle roller mill during the equilibration. The purpose of the mixing is to reduce the aqueous boundary-layer thickness around the sediment particles and the passive sampler to enhance target contaminant mass transfer.

### 2.2.5 Use of Biocides to Inhibit Target Contaminant Biodegradation

For degradable target contaminants (e.g., PAHs), biocides such as sodium azide (100–1000 mg/L) (Cornelissen et al. 2006; Khalil et al. 2006; Zimmerman et al. 2004) or mercuric chloride are required to inhibit biological activity during the experiments. In addition, the experiments should be conducted in the dark or in amber bottles to reduce the chance of photodegradation of some target contaminants.



## 2.3 Field Use

### 2.3.1 *In situ* Deployment Device Designs

An important difference in the field deployment is the physical deployment device used to protect the sampler from harsh environmental conditions or damage during deployment and recovery in sediments. While POM is more rigid than other polymers, such as LDPE and PDMS, the thin POM strips can easily fold up during deployment if they are not adequately supported. Although unframed POM strips have been used by Cornelissen et al. (2008b) and Beckingham et al. (2013) for surface water measurements, for deployment within sediment, the POM sampler is typically encased in a stainless-steel fine mesh and a metal frame such as shown in Figure 2-2. Stainless steel is a suitable metal for use in field deployments, because it resists corrosion adequately. While galvanized iron or aluminum may work for short deployment periods, both are prone to corrosion, especially in saltwater environments. To date, POM samplers have been deployed by wading to the station or by divers as well as attaching POM passive samplers to metal frames fastened to a platform lowered into the seabed at depths exceeding diver limitations (e.g., 60 m) (see Figure 4-4c) (Fernandez et al., 2014). Additional details on field deployment is provided in Appendix F, Case Study 1. As noted in Section 1 (Figure 1-5), in areas where vandalism is a concern, rather than using surface buoys to mark passive samplers, lines can be returned to shore or the application of subsurface buoys may be considered.

## 2.4 Recovery and Processing

POM passive sampling strips deployed in laboratory or field exposures should be removed from any enclosures and rinsed with deionized water to remove attached sediment. The POM strips should be wiped gently with clean laboratory wipes to remove any attached biological growth, and rinsed again with DI water. Do not use any alcohol or solvent-soaked swabs. Note that some discoloration from iron oxide deposits may be difficult to remove, but it is not expected to influence the sorption of target contaminants. The strips should be wiped dry and stored in clean glass vials in a freezer at  $-4^{\circ}\text{C}$ , in the dark, until they are analyzed.



Figure 2-1. Polyoxymethylene passive sampler strip in a laboratory vial (40 mL) for an *ex situ* deployment in a water-sediment slurry for sampling interstitial waters (image provided by SB Hawthorne [University of North Dakota, Grand Forks, ND, USA]).

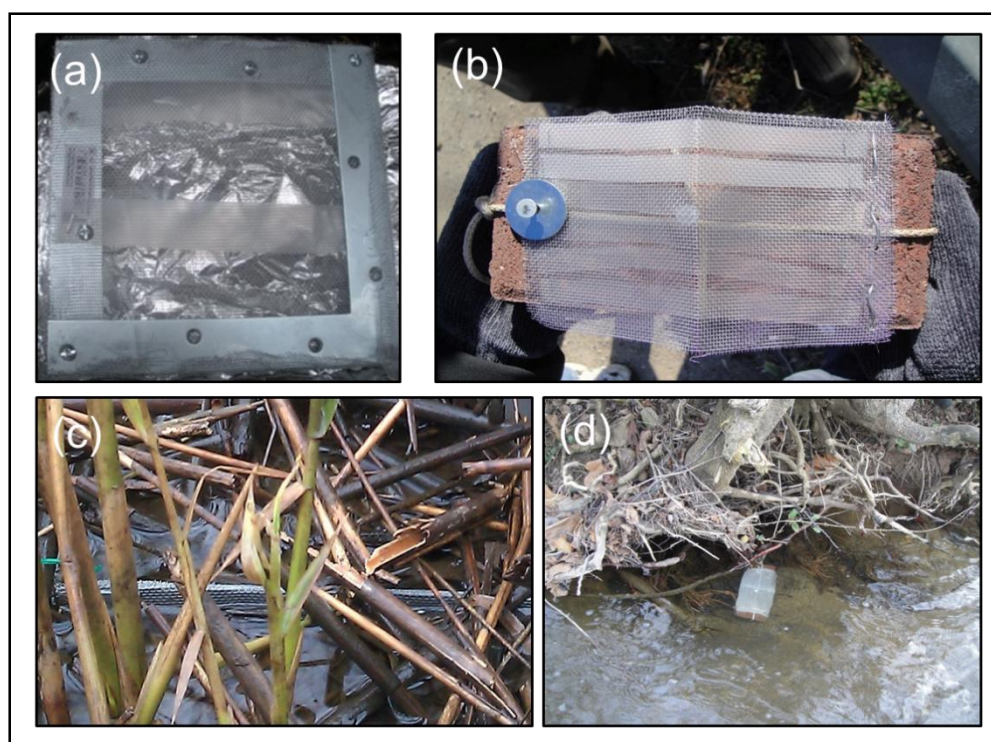

Figure 2-2. Polyoxymethylene passive sampler strips encased in (a) a stainless steel (SS) frame and (b) SS mesh for *in situ* deployment in sediments for sampling (c) interstitial waters and (d) surface waters.

## 2.5 Extraction and Instrumental Analysis

Section 7 discusses the extraction and instrumental analysis of POM.

## 2.6 Data Analysis

Section 8 discusses the analysis of passive sampler data with an emphasis on the calculation of the  $C_{\text{free}}$  of target contaminants.

## 2.7 Selection of Published POM-Water Partition Coefficients ( $K_{\text{POM}}$ )

As discussed in Section 8, a POM-water partition coefficients ( $K_{\text{POM}}$ ) (mL water/g POM) value is needed for calculating the  $C_{\text{free}}$  of the target contaminants. Several researchers have reported  $K_{\text{POM}}$  for a wide range of target contaminants. In all cases, the partitioning has been described by a linear isotherm for a wide range of aqueous concentrations. For this document, in this section, partition coefficients for POM are provided for PCBs and PAHs based on values reported by Ghosh et al. (2014) and first selected as part of a 2012 Society of Environmental Toxicology and Chemistry (SETAC) Pellston workshop on passive sampling (Appendix A). These values are recommended for use to ensure consistency across laboratories in the United States using POM to calculate  $C_{\text{free}}$  for PCBs (Table A-1) and PAHs (Table A-2). Further discussion of passive sampler partition coefficients is provided in Appendix B. This discussion includes alternative partition coefficients for PCBs and PAHs, as well as other target contaminants (e.g., selected pesticides, dioxins and furans) for which available data sets are limited and do not allow for the designation of consensus partition coefficients values at this time.

Along with the list of partition coefficients in Appendix A, correlations have been made between  $K_{\text{POM}}$  and octanol-water partition coefficient ( $K_{\text{OW}}$ ) to allow for the calculation of

$K_{\text{POM}}$  for target contaminants for which empirical partition coefficients are not available. The following correlations relate  $\log K_{\text{POM}}$  for PCBs and PAHs based on Hawthorne et al. (2009, 2011) to  $\log K_{\text{OW}}$  (Hawker and Connell 1988) for PCBs:

$$\log K_{\text{POM}} = 0.791 * \log K_{\text{OW}} + 1.02 \quad [2-3]$$

$(r^2 = 0.95)$

and, similarly, for PAHs,  $\log K_{\text{POM}}$  to  $\log K_{\text{OW}}$  (Hilal et al. 2004):

$$\log K_{\text{POM}} = 0.839 * \log K_{\text{OW}} + 0.314 \quad [2-4]$$

$(r^2 = 0.97)$

A discussion of the effects of temperature and salinity on the partitioning of the target contaminants to polymers can be found in Appendix C.

## 2.8 Empirical Determination of $K_{\text{POM}}$ Partition Coefficients

If reliable  $K_{\text{POM}}$  values for target analytes, such as described in this document, are not available, these partition coefficients may need to be determined experimentally or extrapolated from target contaminant  $K_{\text{OW}}$  values where appropriate within a class of compounds. The PCBs include 209 possible chemical structures (i.e., congeners) and an empirical  $K_{\text{POM}}$  may not be available for every congener. The following approach is an example of how  $K_{\text{POM}}$  values can be determined experimentally for a given PCB congener.

Sorption of PCBs to POM can be determined by measuring sorption isotherms at four different PCB concentrations. Distilled water (100–1000 mL), sodium azide (100 mg/L), and a 25-mg piece of the thinnest commercially available material (e.g., 38- and 76  $\mu\text{m}$  thick POM sheets; CS Hyde Company, Lake Villa, IL, USA) are added to the amber glass bottle with a Teflon-lined lid. The

volume of water chosen at each PCB concentration depends on the analytical detection limit for the target contaminants and the consideration that aqueous solubility of any target contaminant cannot be exceeded. Before use, POM samplers are pre-cleaned via a 12-hour ultrasonic or Soxhlet extraction using a 50:50 acetone/hexane solvent mixture after which they are dried for 12 hours. Individual PCB congeners or mixtures of congeners (e.g., Aroclors) can be purchased from vendors. For example, the PCB Aroclor 1242 is available from Sigma-Aldrich (St Louis, MO, USA) at an initial concentration of 1000 µg/mL in methanol. This mixture can be spiked into quadruplicate vials at four levels ranging from 0.6 to 60 µL and the bottles shaken horizontally at 32 rpm on a shaker for six months, in the dark, to ensure that the system reaches equilibrium (Cornelissen et al. 2008a). After this equilibration period, the POM samplers are carefully removed from the glass bottles and rinsed, dried, and extracted for two days in 12 mL of hexane followed by nine days in 12 mL of 50:50 acetone:hexane. An additional 16-hour Soxhlet extraction with 50:50 acetone hexane resulted in less than 1% of individual PCB congeners remaining in the POM. Mass balances performed after this period to assess recoveries were acceptable, ranging from 70% to 130%, with the majority between 95% and 100% for the two highest Aroclor 1242 concentrations, and 80% to 90% for the two lowest concentrations. Prior to hexane extraction of POM, surrogate standards of 3,5-dichlorobiphenyl (CB14), 2,3,5,6-tetrachlorobiphenyl (CB65), and 2,2',3,3',4,5',6-heptachlorobiphenyl (CB175) were added to monitor recovery. Extracts are combined and switched to hexane before PCB analytical quantification (e.g., gas chromatography/mass spectrometry (GC/MS)). Like the POM, the water phase is also extracted three times with hexane, and samples are prepared for instrumental analysis in an analogous fashion.

The measured POM and water concentrations determined at each spiking level are used to quantify the  $K_{POM}$  (L/Kg) according to the following equation:

$$K_{POM} = \frac{C_{POM}}{C_W} \quad [2-5]$$

where,  $C_{POM}$  (µg/g POM) is the POM sampler concentration, and  $C_{free}$  (µg/mL water) the freely dissolved concentration. To calculate an overall  $K_{POM}$  value for each congener, the average  $K_{POM}$  at each concentration is considered as an individual replicate, and then all values are averaged. This method has previously been identified as preferable to taking the slope of the non-logarithmic isotherm, because this method prevents dominance of higher concentrations (Jonker and Koelmans 2001).

## Section 3

# Passive Sampling with Polydimethylsiloxane (PDMS)

## 3.1 Introduction

Currently, the most common form of polydimethylsiloxane (PDMS) passive sampler, solid-phase microextraction (SPME) uses a hollow fused silica optical fiber coated with the polymer (Figure 3-1). Initially developed as a sample extraction tool for analytical chemistry, SPME with PDMS has been adapted as an environmental passive sampling technique (Arthur and Pawliszyn 1990; Kraaij et al. 2002; Mayer et al. 2000; Smedes and Booij 2012). The thin PDMS coating over a relatively long fiber renders higher surface area-to-volume ratio, which enables PDMS to reach equilibrium faster than PE or POM. For example, long fibers with proper protective casing can be used to monitor the vertical profile of sediment interstitial water contamination (Lampert et al. 2013; Lampert et al. 2011). Concern for the fiber's potential fragility should be addressed when deployments are in harsh environments. For field applications, the thinner fibers are not as robust as the relatively simple passive sampling polymer sheets (e.g., POM, LDPE) and are often deployed in a protected form to avoid loss or breakage (e.g., metal mesh, copper or stainless steel sheath or tubing).

Although not the focus of this document, there are two additional PDMS-based passive sampling techniques worth noting. The first is an *ex situ* method developed by Hawthorne et al. (2005) in which SPME fibers are placed into a small volume (i.e., < 10 mL) of isolated interstitial water treated to remove colloidal matter. Under these conditions, the SPME fiber absorbs freely dissolved target contaminants. This method is not an equilibrium passive sampling method like the others described for nonpolar organic target contaminants in this document as other environmental phases have been removed. The method rapidly accumulates target contaminants on the SPME fiber resulting in low detection limits. The second additional method is also an *ex situ* technique involving coating jars with a thin layer of PDMS (Reichenberg et al. 2008; Jahnke et al. 2012). Contaminated sediments added to the jars are rolled to establish equilibrium between the target contaminants and the PDMS coating. Coatings of different thicknesses of PDMS allow for the determination of equilibrium conditions.

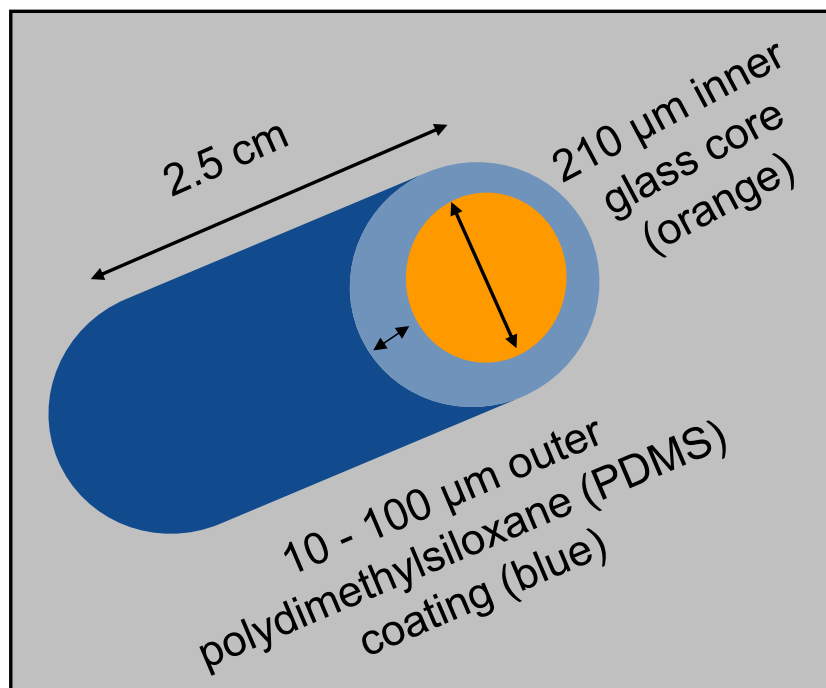

**Figure 3-1.** Schematic of solid phase microextraction fiber showing the outer coating of polydimethylsiloxane (from U.S. EPA 2012b). Dimensions are presented as examples only.

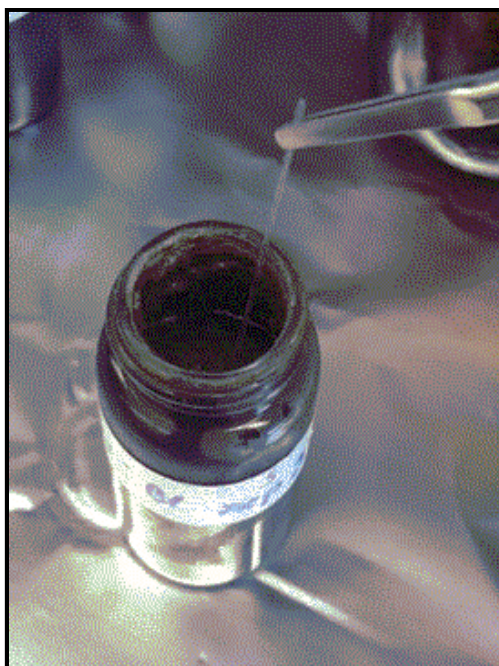

**Figure 3-2.** Insertion of a PDMS coated SPME fiber into whole sediments (in a 20 mL scintillation vial) for an *ex situ* deployment.

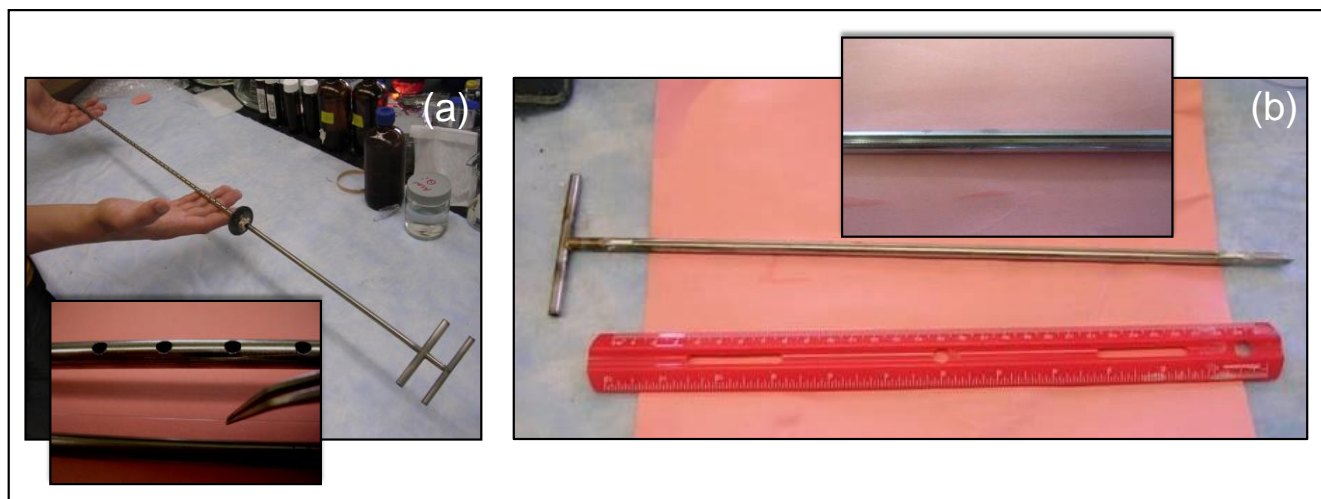

**Figure 3-3. Shielded and unshielded holders for PDMS coated SPME fibers with insets showing the SPME fiber for *in situ* deployments: (a) shielded modified push point type sampler with perforations and marker washer (91 cm in length) and (b) unshielded holder (36 cm in length).**

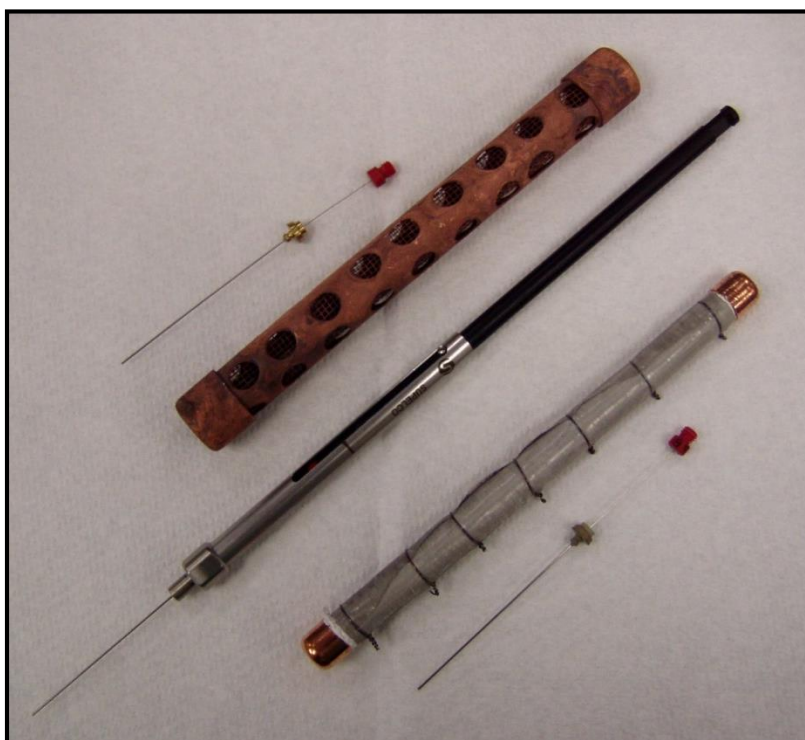

**Figure 3-4. SPME fibers configured to be wrapped in fine stainless steel mesh and fit inside copper (or stainless steel) tubes for *in situ* deployment in the water column or in sediments. SMPE fiber shown are extended from syringes during deployment (based on Maruya et al. 2009).**

## 3.2 Laboratory Preparation

### 3.2.1 Pre-cleaning and Ex situ Deployment

SPME fibers of various PDMS thicknesses are available commercially from vendors including Polymicro Technologies Inc. and Fiberguide Industries (Table 1-1).

Fibers need to be cleaned before each use by sonicating sequentially with a solvent, such as hexane, acetonitrile, or distilled water, that is appropriate for any potential contaminants that may interfere with subsequent analysis. After cleaning, aliquots of solvent can be collected and analyzed to ensure that interfering contaminants were removed. Cleaning procedures can be repeated until no interfering contaminants are detected. After cleaning, the fibers are blotted dry with a laboratory tissue.

In the laboratory, when working with sediment slurries in *ex situ* deployments, PDMS fibers with small diameters (<500  $\mu\text{m}$ ) are easier to locate and recover if inserted through a septum or placed in a metallic mesh bag before deploying in the slurry. Alternatively, a 3 to 12  $\mu\text{m}$  film of PDMS can be coated onto the inside of a glass vial, which avoids the problem of locating the PSD after the exposure (see Section 3.1; Reichenberg et al. 2008; Jahnke et al. 2012). Sheets consisting of PDMS are also commercially available from Altec Products Limited (Bude, UK) and Specialty Silicone Products, Inc. (Ballston Spa, NY, USA), but they have not been used commonly in North America and tend to be fairly thick (~500  $\mu\text{m}$ ).

When applying smaller fibers (<500  $\mu\text{m}$ ), it is effective to deploy the fibers using a syringe to guide them into the slurry. If using thicker fibers (>500  $\mu\text{m}$ ), the fibers can be placed directly into the slurry. Containers with the slurry and fibers can be shaken for an appropriate length of time (e.g., a week) on a shaker table to reach equilibrium. In the

laboratory, when using fibers with whole sediments, they can be placed directly and carefully into sediments without shielding and can be withdrawn and analyzed at any time (Figure 3-2). The fibers' relatively small size (<1 mm diameter) suggests that they can be deployed in intact sediments with minimal disturbance to the surrounding sediment. In coarse sediments, the fiber can be placed in copper or stainless steel containers (i.e., tubes, mesh bags) to protect them from breakage.

Also see Section 2.2 for further considerations when performing *ex situ* deployments with SPME fibers. Section 2.2 focuses on deployments with POM but the factors to consider are similar for SPME fibers.

## 3.3 Field Use

### 3.3.1 Pre-deployment Preparation

This discussion is based on the use of a modified push point sampler with the PDMS polymer (Figure 3-3). *Ex situ*, also called 'matrix SPME', requires pre-use preparation of the polymer, as well as any insertion tools, holders, or supports for the sorbent. Reible and Lotufo (2012) used a stainless-steel modified push point sampler (see Figure 3-3) (M.H.E. Products, East Tawas, MI, USA) for the deployment of PDMS-coated fibers composed of an inner holder and outer stainless steel shield component. The outer shield or sheath is slotted/screened to allow the exchange of interstitial water to the PDMS fiber. As discussed earlier, in shallow, fine-grained sediment environments, the outer sheath may not be needed (Reible and Lotufo 2012). Other configurations include versions used by Maruya et al. (2009) (see Figure 3-4) in which the SPME fiber is enclosed in a copper (or stainless steel) tube with a fine mesh window for water exchange. This style of sampler has also been used in laboratory deployments in aquaria containing sediments (Maruya et al. 2009).



Before loading the PDMS fiber into a holder or placing them directly into the sediments, the polymer and the holder must be cleaned of any potential contamination. The holder can often be scrubbed with hot water and detergent and then rinsed sequentially with solvents appropriate for the contaminants that may interfere with subsequent analysis (e.g., hexane, acetonitrile, distilled water, or others). The components are then dried (e.g., in an oven overnight). The solvents used for cleaning are typically the same as those used to extract the PDMS after the exposure, which ensures that the sampling equipment is free of contaminants that are extractable by the analysis solvent. Reible and Lotufo (2012) used acetonitrile as a primary cleaning solvent when analyzing for PAHs because acetonitrile was also used as the carrier solvent for analysis of PAHs by high performance liquid chromatography (HPLC) with fluorescent detection. Similarly, Reible and Lotufo (2012) used hexane as a primary solvent for PCBs analysis, because their GC/ECD analytical method used hexane as a carrier solvent.

For deployed devices, the cleaned fibers are laid into the groove of the inner holder of the modified sampler and affixed with approximately 1 cm of waterproof caulk (hydrocarbon-free silicon) at both ends. Caulk is used to hold the fiber in place, and can also be used to fill any gaps between the holder and the shield at the ends of the insertion tool, to eliminate any vertical water movement. Care should be taken to avoid any placement of silicon on the screened length or active measurement portion of the insertion tool. Also avoid placing too much silicon, so that the cured silicon hinders separation of the insertion tool from the fiber or outer sheath after field deployment. After the caulk dries, the inner holder is inserted into the outer sheath, with groove and fiber aligned with the screened side of the sheath. The handles on both the inner grooved holder and sheath are wrapped

together to maintain orientation of the fiber to the screened section of the outer sheath. The length of the fiber loaded into each insertion tool is documented, and the samplers are labeled via a waterproof marker.

### 3.3.2 *In situ Deployment*

For *in situ* field application of PDMS, the fiber should be placed in an outer holder to protect it from breakage. In coarse sediments (gravel, rocky, or filled with debris) the holder should include an external sheath to help protect the fiber. As discussed previously, the holder or sampler used herein is modified from a hand-held piezometer (i.e., push point sampler). Modifications include adding perforations in the outer sheath to allow water exchange, incorporation of a slit into the inner sheath to hold the SPME fiber, and adding a washer to mark the sediment/water interface (Figure 3-3a). Fibers can be left unshielded for short lengths (up to 30 cm) in soft sediments (Figure 3-3b). Other types of samplers or fiber holders are acceptable, as long as they can protect the fiber from breakage, do not interfere with water and fiber exchange, and can be easily deployed.

In the field, use of PDMS fibers is more complicated, because placement typically requires divers, and shielding to protect the fibers during placement. The modified push point sampler based system was found to be simple to deploy in all but the most difficult of subsurface environments (e.g., sediments armored by rock). The primary difficulty is ensuring proper vertical placement, particularly in soft sediments where the lack of resistance of the sediment makes it difficult to define the sediment/water interface. Retrieval by divers or remotely by pulling on an attached line has been demonstrated at multiple field locations. However, as noted in Section 1.7, using divers will involve special considerations including appropriate personal protective equipment (PPE) usage. Consulting with U.S. EPA

experts on diver based deployment and retrieval is recommended.

For *in situ* placement into sediment, the assembled SPME insertion devices are driven perpendicular into the sediment surface by divers at locations not accessible on foot. An alternative method uses a long, sleeved pipe to insert the sampler into the sediment from the surface. Samples can also be collected by conventional cylindrical or box corer and placed in the laboratory before insertion of the sampler. Sampling in the laboratory is similar to the field, except that the effects of field-related processes such as groundwater upwelling and tides will not be included.

All SPME insertion devices are marked during deployment to allow retrieval. This might include cording to surface-deployed buoys or cording run to a nearby shore. The samplers can be pushed into sediment by hand at easily accessible sites (e.g., onshore locations at low tide and shallow creeks). Deployment blanks (also considered a field blank) can be shipped to the field but not deployed, to assess possible sources of contamination to the sampler on site or during shipping. For SPME, the deployment blanks should be processed (i.e., transferred to vials and solvent added) at the time of deployment. A field blank can also be used for retrieval. No retrieval field blank is needed if the samplers are processed on site immediately after retrieval.

As noted in Section 1 (Figure 1-5) and above, in areas where vandalism is a concern, rather than using surface buoys to locate passive samplers, lines can be returned to shore or the application of subsurface buoys may be considered.

### 3.4 Recovery and Processing

All fibers are typically equilibrated *in situ* for 7 to 28 days before retrieval. The equilibrium time is chosen as a balance between using short

times to minimize sample disturbance or vandalism and the time required to achieve a significant fraction of equilibrium for highly hydrophobic contaminants. Full equilibration involves the initial depletion of the interstitial water surrounding the fiber and then slow re-equilibration with the surrounding media. The time required to achieve full equilibrium depends on the hydrophobicity of the target contaminant being analyzed, the dimensions of the PDMS polymer, and the mixing characteristics within the sediment. A highly hydrophobic contaminant (e.g., a tetrachloro- or higher chlorinated biphenyl), in a medium that is easily depleted due to low sorption capacity (e.g., sand), under conditions of limited transport (e.g., diffusion-controlled conditions) may require well in excess of 28 days to achieve full equilibrium. A less hydrophobic contaminant (e.g., 3- or 4-ring PAH) may reach equilibrium within a period of days in a typical fine-grained organic-rich, and therefore high-capacity, sediment. Lampert et al. (2015) discuss a modelling approach for estimating how much time is required to achieve equilibrium between the target contaminants and the PDMS polymer.

After deploying the fibers for the specified length of time in the sediment to be sampled, they are removed from the sediment. It is generally convenient to process the fibers immediately, to maximize sample integrity. Low-molecular-weight and volatile contaminants (e.g., naphthalene or less hydrophobic/more volatile chemicals) are not easily measured, due to minimal concentrations on the fiber and rapid volatilization on exposure to the atmosphere.

Samplers deployed in the field are first dismantled from the solid support (e.g., push point sampler). The sorbent fiber is removed, cleaned with water or a damp laboratory tissue to remove any sediment particles, and either placed on ice for shipment to the laboratory or

sectioned and placed into extracting solvent in the field. Due to the relatively slow kinetics of uptake or loss of target contaminants from the sorbent when exposed to water, quick rinsing will not alter the concentration on the sorbent. Processing of PDMS fibers onsite by sectioning and placing into auto-sampling vials with inserts prefilled with aliquots of solvent is an effective processing method that stabilizes the samples for shipment to the processing laboratory without concern for sample degradation during transport.

The passive sampling materials can be cut into different segment sizes based on the objectives of a given project. For example, sampling within the biologically active zone (e.g., 0–10 cm) would characterize exposure to benthic organisms, while sampling in deeper segments (e.g., 10–20 cm, 20–30 cm, etc.) may indicate potential migration from below into the biologically active zone. Vertical diffusion of contaminants along the PDMS fiber likely limits vertical resolution to 1–2 cm, depending on the time of exposure. Normally, adjacent 1- to 2-cm sample segments can be used as duplicate samples under most environmental conditions.

Any observances of color change and odor of the passive sampling material or solid support should be documented. Changes in color may be due to changes in the biogeochemistry of the sediment or the presence of non-aqueous-phase liquids (NAPLs) which can also be detected by odor. Note that contact with NAPL can affect the validity of the interstitial water measurements, because the passive sampling material may directly absorb the NAPL. This would cause the concentration in the polymer sorbent to be much higher than if the sorbent were exposed only to water equilibrated with the same NAPL phase. If NAPL contamination of the PDMS is suspected, the calculation of  $C_{\text{free}}$  should not be

performed as the derived values will likely be over-estimations.

### 3.5 Extraction and Instrumental Analysis

The SPME fibers can be liquid extracted like the other types of passive samplers (see Section 7). However, unique to SPME, the fibers can be cut into segments, followed by placement into an auto-sampling vial with an insert and aliquot of solvent, followed by analysis via direct injection into the analytical instrumentation (e.g., GC or HPLC) (see Section 7). The lack of additional processing steps when using direct injection is a major advantage of the method, reducing time, cost, and potential contaminant losses due to sample cleanup or extraction steps.

### 3.6 Data Analysis

See Section 8.

### 3.7 Selection of Published PDMS-Water Partition Coefficients ( $K_{\text{PDMS}}$ )

Several researchers have reported PDMS-water partition coefficients ( $K_{\text{PDMS}}$ ) for a wide range of target contaminants. In all cases, the partitioning has been described by a linear isotherm for a wide range of aqueous concentrations. For this section, partition coefficients for PDMS are provided for PCBs and PAHs based on values reported by Ghosh et al. (2014) and first selected as part of a 2012 Society of Environmental Toxicology and Chemistry (SETAC) Pellston workshop on passive sampling (Appendix A). These values are recommended for use to ensure consistency across laboratories in the United States using PDME to calculate  $C_{\text{free}}$  for PCBs (Table A-1) and PAHs (Table A-2). Further discussion of passive sampler partition coefficients is provided in Appendix B. This discussion includes alternative partition coefficients for PCBs and PAHs, as well as other target contaminants (e.g., selected pesticides, dioxins,

and furans) for which available data sets are limited and do not allow for the designation of consensus provisional partition coefficients at this time.

Along with the listing of partition coefficients in Appendix A, correlations have been made between  $K_{PDMS}$  and  $K_{OW}$  to allow for the calculation of  $K_{PDMS}$  (mL water/g PDMS) for target contaminants for which empirical partition coefficients are not available. The following correlations relate  $\log K_{PDMS}$  for PCBs and PAHs based on Smedes et al. (2009) to  $\log K_{OW}$  (Hawker and Connell 1988) for PCBs:

$$\log K_{PDMS} = 0.947 * \log K_{OW} + 0.017 \quad (r^2 = 0.89) \quad [3-1]$$

and, similarly, for PAHs,  $\log K_{PDMS}$  to  $\log K_{OW}$  (Hilal et al. 2004):

$$\log K_{PDMS} = 0.725 * \log K_{OW} + 0.479 \quad (r^2 = 0.99) \quad [3-2]$$

Partition coefficients for PCBs and PAHs were prepared using a particularly thick sheet of PDMS (J-Flex SR-TF). The values are consistent with PDMS-coated fibers (DiFilippo and Eganhouse 2010; Hsieh et al. 2011; Smedes et al. 2009). Also shown in these tables are partition coefficients for a different PDMS, Altesil, also measured by Smedes et al. (2009) to illustrate the potential variability of  $K_{PDMS}$  values from different sources. A discussion of the effects of temperature and salinity on the partitioning of the target contaminants to polymers can be found in Appendix C.

## Section 4

# Passive Sampling with Low-Density Polyethylene (LDPE)

## 4.1 Introduction

Low-density polyethylene (LDPE) is one of the most commonly used thermoplastics, with numerous product applications including bags, bottles, containers, and geomembranes (Lohmann 2012). This inexpensive material can be purchased in bulk and is available in thin sheets or film forms that can be easily cut to fit various experimental designs. The thin sheet or film form can maximize the surface-area-to-volume ratio, achieving low detection limits and faster equilibrium times (Adams et al. 2007; Lohmann, 2012, Apell et al. 2015). While LDPE use for laboratory or *ex situ* testing is possible (e.g., Lohmann et al. (2005) used LDPE to infer partition coefficient values of PAHs, PCBs and a dioxin), field deployment has been the primary application. The following discussion emphasizes polymer preparation and usage associated with *in situ* and *ex situ* observations.

## 4.2 Laboratory Use

### 4.2.1 Pre-Deployment Preparation

Low-density polyethylene is most easily purchased from hardware/painting stores in large sheets (e.g., drop cloth or plastic tarp material; Figure 4-1) with thicknesses of 13  $\mu\text{m}$  (0.5 mil), 25  $\mu\text{m}$  (1 mil), 51  $\mu\text{m}$  (2 mil) and 76  $\mu\text{m}$  (3 mil) depending on the user's need for strength (choose thicker) and desire for short deployment times (use thinner) (see Table 1-1). The sheet is cut into strips sized for the

environment and support frames/meshes to be used.

An organic solvent cleaning sequence is then used to prepare the LDPE (Figure 4-1). In this process, the samplers are completely submerged in the solvent. This process ensures that extractable oligomers, plasticizers, and contaminating organic chemicals are removed from the LDPE prior to use. All extractions are performed sequentially in the same container. Methylene chloride is placed into the extraction vessel and the LDPE strips are immersed in the container for 24 hours, to allow time for diffusive transfers out of the LDPE (placing the samplers on an orbital mixer will accelerate this process). The initial methylene chloride extract is discarded, and a second methylene chloride extraction is performed for 24 hours. The second methylene chloride extract is discarded and replaced by methanol in order to remove methylene chloride from the LDPE. Methanol immersion is also performed for 24 hours. The initial methanol extract is discarded and followed by a second methanol soak for 24 hours. Finally, the second methanol extract is discarded, and the LDPE undergoes three 24-hour soaks in the same extraction vessel with high quality water (e.g., free of DOC and HOCs) to remove residual methanol from the LDPE. The cleaned LDPE is stored in high quality deionized water in the extraction vessel until further processing. See Section 6 on the impregnation and use of PRCs prior to field deployment.

### 4.2.2 *Ex situ* Deployment

For the *ex situ* deployment of LDPE, the guidance provided in Section 2.2 for POM sheets can be applied. Given the similarity between LDPE and POM, nearly identical laboratory-based deployments can be performed.

### 4.3 Field Use

Shortly before deployment, the LDPE is cut into strips and the films fixed within a

deployment support system suited to fully expose the LDPE surface to its environmental surroundings while protecting the LDPE from damage. In the case of sediment bed testing, the LDPE can be held stretched out between a pair of metal frames (e.g., aluminum, stainless steel) (see Figure 4-2 for a specific design). The frames are connected together using nuts and bolts with the LDPE sheet pierced by the bolts. The bottom of the frame can be pointed to help with insertion into a sediment bed, and the upper portion can have holes that allow connection of recovery lines.

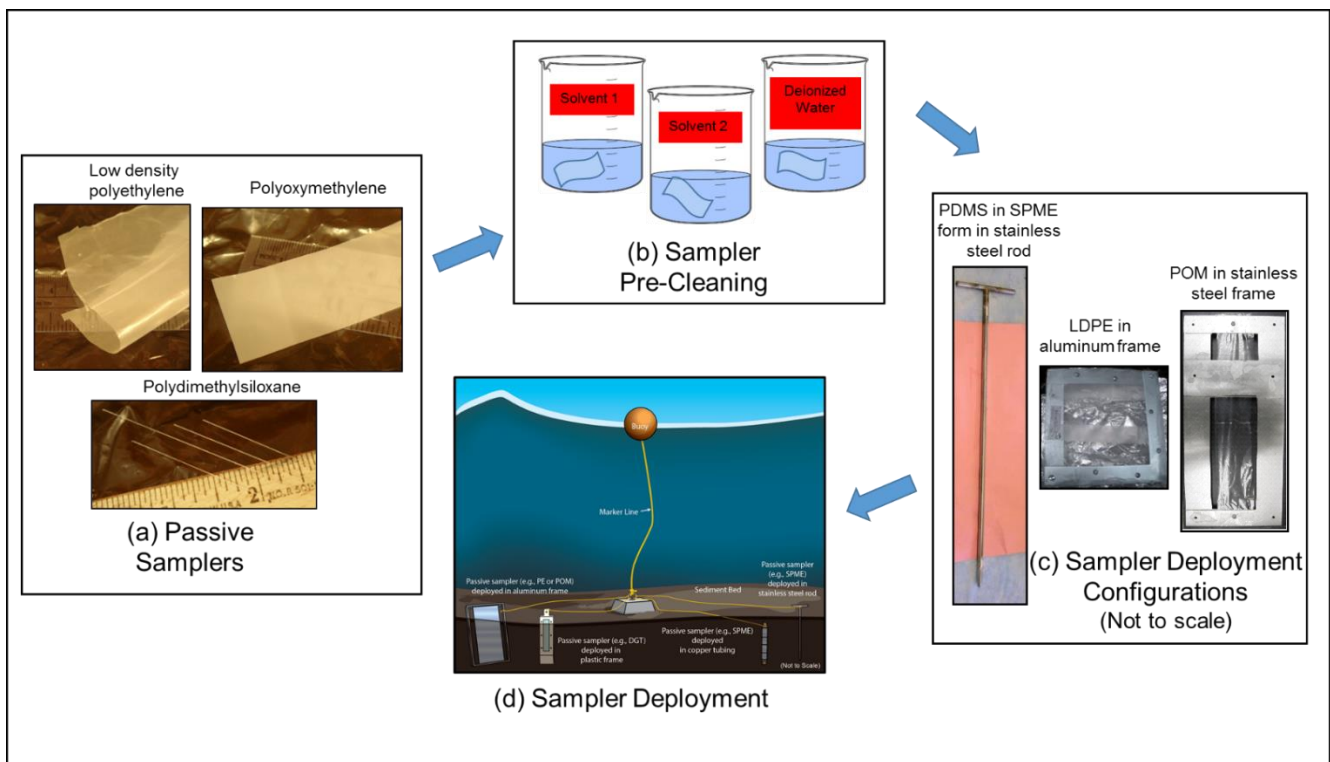

**Figure 4-1. Sequence of steps used to prepare passive samplers for *in situ* field deployment: (a) selection of passive samplers; (b) pre-cleaning of samplers with organic solvents and deionized water; (c) configuration of passive samplers for field deployment; and (d) deployment of passive samplers in the field (Also see Figure 1-5) .**

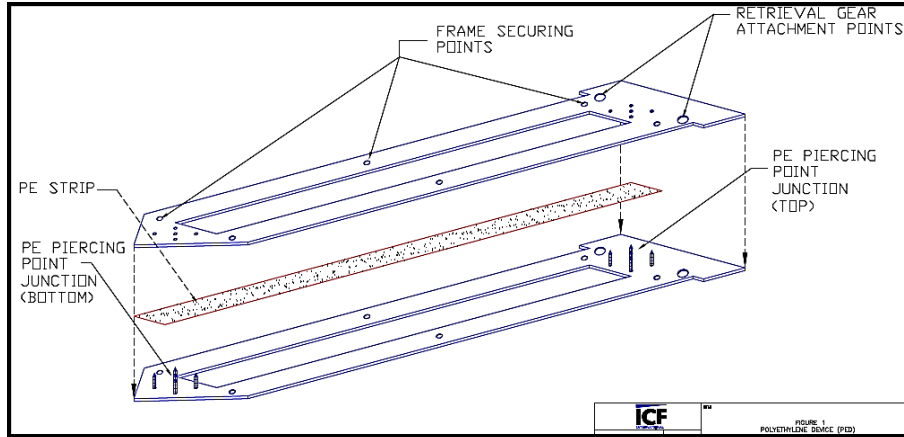

**Figure 4-2. Schematic of a LDPE passive sampling configuration using two aluminum sheet frames (blue) “sandwiching” a 50 cm strip of LDPE (red) positioned in a “window” for exposure to the water column and sediments during deployment (drawing by ICF International [Fairfax, VA, USA]).**

If one wants to deploy water-column samplers during the same field campaign, then the LDPE can be deployed by placing it inside a metallic mesh (e.g., aluminum, copper, stainless steel) (Figure 4-3). The mesh protects the LDPE from attack by aquatic organisms (we have observed that ribbons of LDPE deployed for a month had been chewed on). The mesh also enables grommets to be used that enable easy attachment to recovery gear.

After the LDPE is placed in the metal frame or mesh, the entire assembly is wrapped carefully and completely in solvent-cleaned, heavy-duty, metal foil. The wrapped samplers are also labeled on the outside for field crew identification, and then they are carefully arrayed in a clean shipping container (e.g., a cooler) on ice or ice packs.

For deployment in the field, additional equipment and lines are used. For example, for LDPE insertion into relatively shallow sediments (<5 m), the LDPE frame can be inserted and locked into a toggle-locking device (TLD), which is specifically designed for LDPE installations (Figure 4-4b). The LDPE is then lowered through the water

column to the surface of the sediment bed and driven into the sediment so that the LDPE strip within the frame is positioned across the sediment-surface water interface. The frame is then unlocked from the TLD and left in place. For deployments in moderate depth waters (e.g., approximately  $\leq 20$  m), divers can be used to insert the frames into the bed sediment. Finally, at still deeper locations, LDPE in the frame can be affixed to a deployment platform and the platform lowered from a vessel to the sediment surface, where the weight of the platform causes the frame to be inserted into the sediment bed (Figure 4-4c) (Fernandez et al. 2014; Fernandez 2009a, b). In addition, using a hydraulically operated device, the LDPE sampling frame can be mechanically pressed into the sediment (Figure 4-4d, Marine Sampling Systems, Burley WA). In all cases, recovery lines are attached to the support frame, and these lines are connected to nearby pilings, marker surface or subsurface buoys, or remote releasing devices. As noted in Section 1 (Figure 1-5) in areas where vandalism is a concern, rather than using surface buoys to locate passive samplers, lines can be returned to shore or the use of subsurface buoys may be considered.



**Figure 4-3. LDPE film deployed inside an aluminum mesh packet.**

LDPE is typically left in place for a period of weeks to months, depending on the target contaminants of interest. During the deployment, the target HOCs diffuse into the LDPE from the surrounding sediments. As discussed in Section 6, for field (*in situ*) deployment of LDPE, the use of performance reference compounds (PRCs) is highly recommended. While the target contaminants accumulate in the sample, the PRCs are simultaneously diffuse out of the LDPE. Use of these PRCs is essential, because the rates of mass transfer of contaminants from the environment into the LDPE sheets can be influenced by several environmental factors (Apell et al., 2015) (e.g., sorption coefficients of adjacent sediments; turbulence intensity in adjacent surface water, the uneven formation of growths, and precipitates that build up on the LDPE surface) (Figure 4-5).

#### 4.4 Recovery and Processing

On recovery from the field exposure, the LDPE, while still in the frame, should be cleaned carefully. While the formation of biofilms and epiphytic growth on LDPE surfaces does not prevent the polymer from accumulating target contaminants during deployment, these coatings can substantially complicate subsequent chemical analysis (see Section 7). Careful removal of adhering sediment or surface growths via water-wetted laboratory wipes may be necessary. Next, the LDPE is cut into the appropriate segment lengths (e.g., to acquire sections exposed to varying depths in the sediment bed and water column). The LDPE pieces, usually 10- to 100-mg quantities, are placed in pre-cleaned, amber glass vials or bottles with a drop of high purity deionized water for shipping. The water



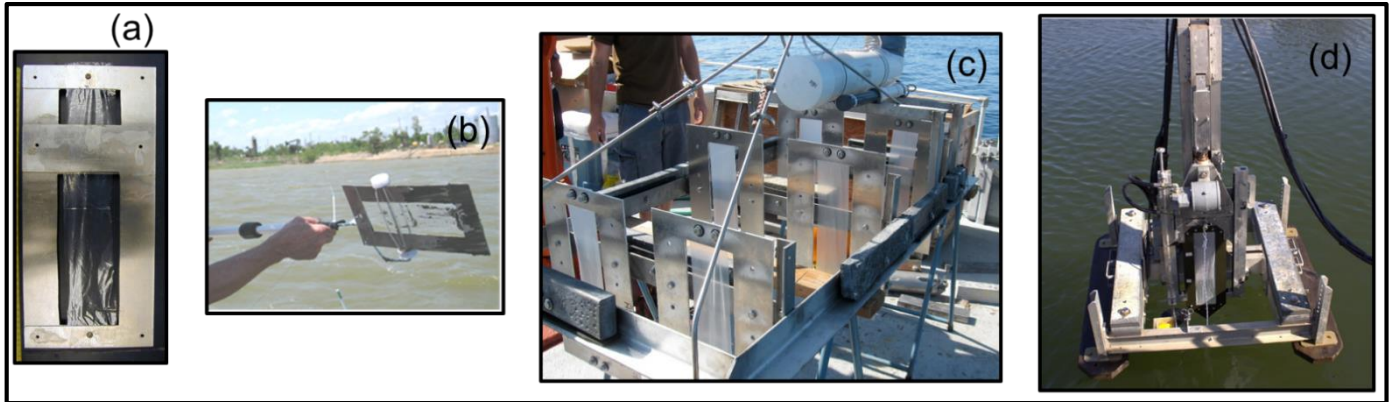

**Figure 4-4. Photographs of various systems for deploying LDPE in the water column and sediments in the field: (a) the LDPE film mounted in aluminum or stainless steel frame; (b) hand deployed system for shallow/tidal locations using a ~5 m long pole and toggle-locking device (TLD); (c) a weighted frame system (Fernandez et al. 2014) and (d) mechanically pressed system for deployments from vessels in deep water (>50 m). This type of LDPE sampler system can also be deployed in intermediate water depths (<35 m) by divers.**

**Figure 4-5. Photograph of LDPE in an aluminum frame after deployment in a freshwater lake sediment. The lower portion of the LDPE, which still appears transparent, was embedded below the sediment-water interface; in contrast, the LDPE in the lake bottom water was coated in material that may affect target contaminant uptake rates in the LDPE.**



is intended to cause the vessel to maintain 100% relative humidity, thereby limiting sorption of target contaminants to the walls of the glass vials. Alternatively, the LDPE can be placed between clean glass or metal plates or metal foil during transport and sectioned at the laboratory. Once back at the laboratory, the samplers are stored at  $-4^{\circ}\text{C}$  in the dark unless extractions can be started by submerging the PE in organic solvent.

#### 4.5 Extraction and Instrumental Analysis

See Section 7.

#### 4.6 Data Analysis

See Section 8.

#### 4.7 Selection of Published Low-Density Polyethylene-Water Partition Coefficients ( $K_{\text{LDPE}}$ )

Several researchers have reported LDPE-water partition coefficients ( $K_{\text{LDPE}}$ ). In all cases, the partitioning has been described by a linear isotherm for a wide range of aqueous concentrations. For this document, partition coefficients for LDPE are provided for PCBs and PAHs based on values reported by Ghosh et al. (2014) and first selected as part of a 2012 Society of Environmental Toxicology and Chemistry (SETAC) Pellston workshop on passive sampling (Appendix A). These values are recommended for use to ensure consistency across laboratories in the United States using LDPE to calculate  $C_{\text{free}}$  for PCBs (Table A-1) and PAHs (Table A-2). Further discussion of

passive sampler partition coefficients is provided in Appendix B. This discussion includes alternative partition coefficients for PCBs and PAHs, as well as other target contaminants (e.g., selected pesticides, dioxins, and furans), for which available data sets are limited and do not allow the designation of consensus provisional partition coefficients values at this time.

Along with the listing of partition coefficients in Appendix A, linear free energy relationships (LFERs) have been made between  $K_{\text{LDPE}}$  (mL water/g LDPE) and  $K_{\text{OW}}$  to allow for the calculation of  $K_{\text{LDPE}}$  for target contaminants for which empirical partition coefficients are not available. The following LFERs relate  $\log K_{\text{LDPE}}$  for PCBs and PAHs based on Smedes et al. (2009) to  $\log K_{\text{OW}}$  (Hawker and Connell 1988) for PCBs:

$$\log K_{\text{LDPE}} = 1.18 * \log K_{\text{OW}} - 1.26 \quad (r^2 = 0.95) \quad [4-1]$$

and, similarly, for PAHs,  $\log K_{\text{LDPE}}$  to  $\log K_{\text{OW}}$  (Hilal et al. 2004):

$$\log K_{\text{LDPE}} = 1.22 * \log K_{\text{OW}} - 1.36 \quad (r^2 = 0.99) \quad [4-2]$$

Alternatively, additional LFERs for LDPE with PCBs and PAHs are included in Appendix B.

A discussion of the effects of temperature and salinity on the partitioning of the target contaminants to polymers can be found in Appendix C.

## Section 5

# Passive Sampling with Diffusive Gradient in Thin Films (DGT)

## 5.1 Introduction

Users of this document should be aware that the DGT technology is not as established as the passive sampling technology for the hydrophobic organic contaminants. The DGT methodology included in this document for completeness in presenting the primary passive sampling technologies used in North America and to make the document user aware of the DGT approach while also recognizing that the technology is continuing to mature.

DGTs for sediments are composed of three layers of material that are stacked and exposed to the sediment (Figure 5-1). The outer layer (direct contact with sediment) is an organic membrane filter, which allows only dissolved metal species (e.g., cadmium, copper, nickel, lead, zinc) to interact with the gels within the DGT. Below the filter is a diffusion hydrogel (typically polyacrylamide, though agarose has also been used) of a known thickness, through which the metals diffuse at a known rate. Below the diffusion gel is a resin gel (Chelex-impregnated polyacrylamide) which binds metals passing through the diffusion gel and have high binding constants with the Chelex functional groups. The three materials are secured together in a plastic housing, inserted into the sediment, and rapidly begin accumulating any metals dissolved in the interstitial water. Because the resin gel is actively and rapidly accumulating metals, concentrations above analytical thresholds can typically be achieved after short deployment times (<24 hr). The pore size of both the filter and the polyacrylamide hydrogel effectively excludes any particulate and colloidal metals,

yet some DOC-bound metals can be sampled by the DGT (Davison and Zhang 1994; Zhang 2004; Warnken et al. 2008).

For metals that have high binding constants (and no kinetic limitations) with the resin functional group, for standard exposure times (hours to days) and for typical trace metal pore-water concentrations, the resin gel acts as an infinite sink for metals. This establishes a linear diffusion gradient through the diffusion gel (Figure 5-2). Diffusion kinetics in the gel are well described (Davison and Zhang 1994; Harper et al. 1998) and a concentration at the surface of the DGT ( $C_{DGT}$ ) can be calculated from the mass of metal bound to the resin gel (See Equation 8-4).

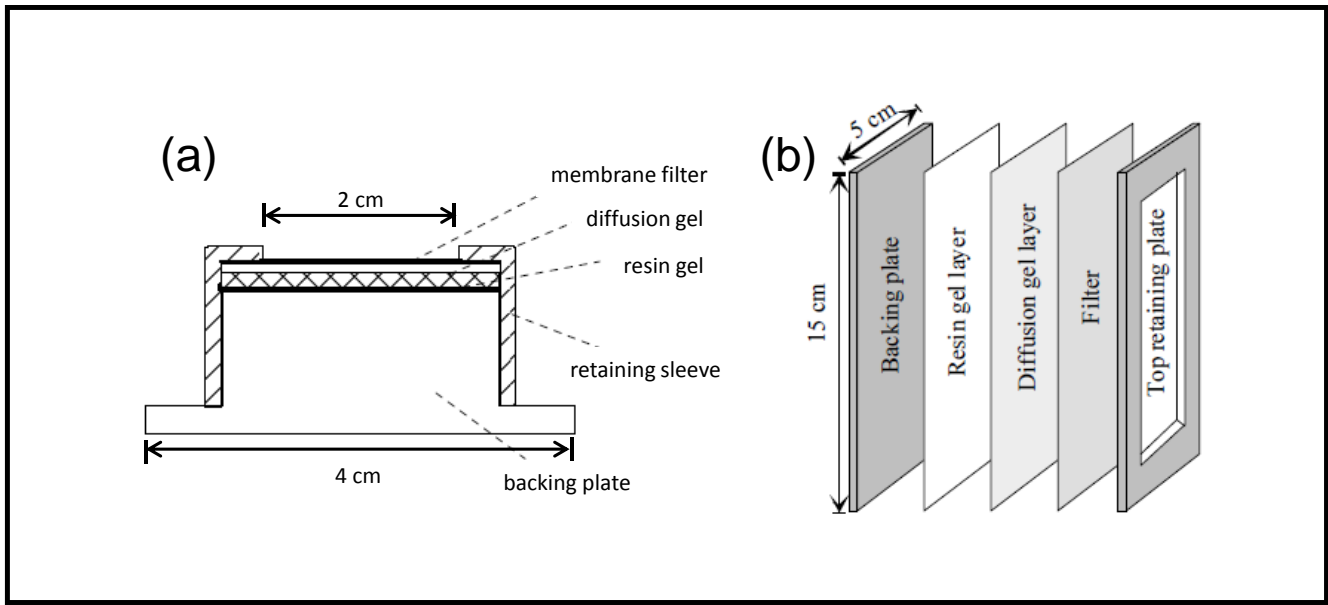

Figure 5-1. Schematic of commercial DGT disks in (a) cross-section and (b) DGT sediment probes in exploded view (based on images from DGT Research Ltd. website).

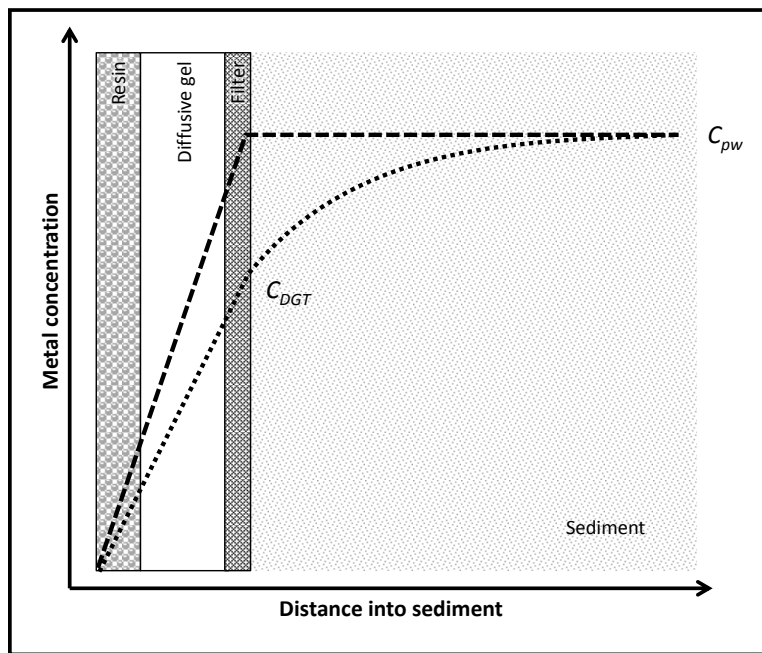
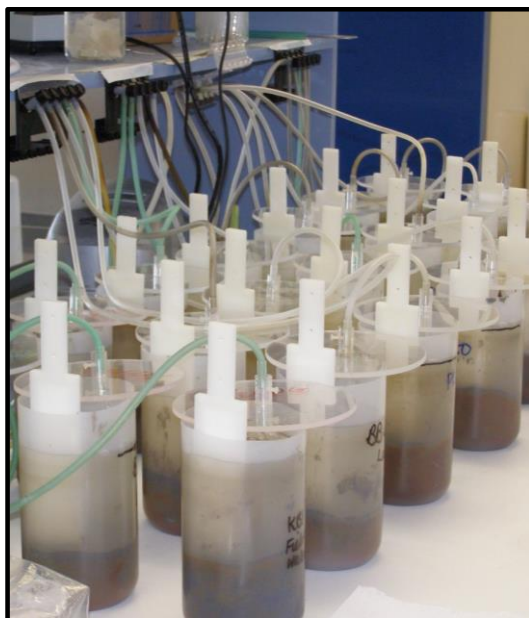

Figure 5-2. Theoretical diagram of metal concentrations in the DGT device and interstitial water during DGT exposure. With complete mixing (unlikely in sediments) or rapid resupply of metals from solid phases, the concentration at the DGT surface is identical to the concentration in the interstitial water ( $C_{pw}$  in the figure) (dashed line). When resupply is slower, the concentration at the surface of the DGT ( $C_{DGT}$ ) is lower than the interstitial water concentration (figure adapted from Harper et al. (1998)).

## 5.2 Preparation and Laboratory Use

Unlike POM, PDMS and LDPE which require some assembly prior to deployment, DGTs can be purchased as assembled units from the manufacturer or selected components can be ordered (e.g., resin gel) (DGT Research Ltd.) (see Table 1-1) for assembly by the user in standard or custom-built housings. Commercially available DGTs for use in sediments are available in two possible configurations: a DGT disk (Figure 1-4a) or a DGT probe (Figure 1-4b). The DGT probe can be inserted into the sediment vertically to assess the vertical distribution of metals (Figure 5-3), and the DGT disk can be placed on the sediment surface to measure metal flux to surface waters. Commercially available DGTs typically have a filter membrane with a pore size of  $0.45\ \mu\text{m}$ , diffusive hydrogel with a thickness of 0.8 mm, and resin impregnated gel with a thickness of 0.4 mm.

Prior to use, DGTs should be marked (probes only) and deoxygenated. DGT probes should be marked with a fine marker to denote the location of the sediment/water interface. The manufacturer recommends placing the mark  $\sim 1\text{--}2$  cm below the top of the window, but if the sediment is shallow or compacted, it may be more appropriate to place the mark lower. Note that the depth to which the DGT will accumulate metals is determined by the distance from the mark to the bottom of the window. It is recommended that DGTs be deoxygenated prior to use, which is particularly important for vertical probes that will likely interact with anoxic sediments. DGTs can be deoxygenated for 24 hours in trace metal clean  $0.01\text{M}$  NaCl that is gently bubbled with  $\text{N}_2$  or Ar gas.



**Figure 5-3. Photograph of the *ex situ* deployment of DGT samplers in simulated water column – whole sediment system (image provided by S Simpson [CSIRO, Sydney, Australia]).**

## 5.3 Field Use

DGTs have been used effectively *in situ* for both water column and sediment assessments of labile (e.g., Costello et al. 2012). DGTs should be used soon after deoxygenating, to minimize the introduction of oxygen into the sediment by DGT placement. DGTs are transported in sealed plastic bags in a cooler to the field site and deployed within 24 hrs. DGT disks are used by pressing the assembly gently onto the surface of the sediment. Disk assemblies are slightly negatively buoyant and will maintain contact with the sediment under static conditions. However, in flowing waters, it is necessary to weigh down the DGT disks or use the DGT probe assembly. The DGT probe assembly is inserted into the sediment vertically, with a smooth motion, until the marked line is at the sediment/water interface.

Be sure to note the time of DGT deployment and the temperature of the sediment (i.e., temperature is a variable in calculating the diffusion coefficient ( $D$ )). The DGT deployment time should be sufficiently long to accumulate a measureable quantity of metal on the resin but short enough to avoid depleting the supply of metal in the interstitial water (see below). In some cases, retrieval of replicate DGTs at different time points can yield useful information about metal dynamics. For single retrieval, a deployment time of ~24 hours has been used successfully and is recommended.

For sediment assessments, it is recommended that the vertical DGTs (with 15-cm by 1.8-cm exposure windows) be used and gently inserted approximately 10 cm into the sediment. The depth of penetration should be measured and then rechecked at retrieval. This approach allows for determination of the differences in labile metals associated with deep and surficial sediments, and also the overlying waters. If DGTs are deployed repetitively through time, then temporal changes also can be assessed (Costello et al. 2012). As noted in Section 1 (Figure 1-5), in areas where vandalism is a concern, rather than using surface buoys to locate passive samples, lines can be returned to shore or the use of subsurface buoys may be considered.

## 5.4 Recovery and Processing

After deployment, the DGTs are removed from the sediment and stored until processing. DGTs are removed gently from the sediment, and any adhering sediment particles are washed off with deionized water. If processing is not performed immediately (e.g., field-deployed DGTs), the DGT apparatus can be stored in a clean plastic bag and refrigerated.

For DGT disks, the plastic housing is removed by placing a flat-head screwdriver in the slot and twisting until the outer housing pops off. Without disassembling the probe, the filter and gels can be cut along the edges of the DGT housing window using a Teflon-coated razor. It is important to cut entirely through to the bottom of the gels, because the resin gel can easily deform. The entire gel and filter section is removed from the housing using plastic forceps and placed on an acid-cleaned Perspex or Lucite plate (i.e., polymethyl methacrylate (PMMA)). The membrane filter and diffusive gel are removed carefully and discarded. Using the Teflon-coated razor blade, carefully cut measured sections of the resin gel corresponding to the appropriate sediment depth. Sections can range from 1 to 20 mm, depending on the resolution required.

## 5.5 Extraction and Instrumental Analysis

See Section 7.

## 5.6 Data Analysis

See Section 8.

## Section 6

# Selection and Use of Performance Reference Compounds for Hydrophobic Organic Target Contaminants

## 6.1 Introduction

While many passive samplers used with hydrophobic organic contaminants have been shown to reach equilibrium with sediment in well-mixed slurry systems within a month, the time necessary to reach equilibrium under field-deployed (i.e., *in situ*) conditions is slow. Performance reference compounds (PRCs) can be used to estimate the extent of equilibrium of the target contaminant(s) and provide a method to then adjust measured accumulated target contaminant levels to equilibrium concentrations. In passive sampler deployments where the demonstration of target contaminant equilibrium with the passive sampler is not determined directly using temporal sampling or different polymer thicknesses, PRCs can be used. One clear benefit of using PRCs is that they take into consideration the effects on attaining equilibrium of biofilm growth and fouling on the passive sampler surface. Consequently, it is highly recommended that PRCs be applied to passive sampling deployments whenever possible. PRCs are chemicals that behave like the target contaminants and are loaded into the passive sampler polymer prior to the deployment (Huckins et al. 2002). A good PRC should (i) allow precise measurement of its loss, (ii) follow similar same kinetics bracketing the target analyte, and (iii) not occur in the environment (Fernandez et al. 2009a; Huckins et al. 2002). Performance reference

compounds have been used with LDPE and POM and less often than with PDMS-based systems. Because of the very small mass of PDMS associated with the SPME fiber, target contaminants are often considered to achieve equilibrium with it relatively rapidly compared to LDPE and POM. This PRC-free approach with PDMS has been explored in *in situ* deployments (e.g., Witt et al. 2013; Maruya et al. 2015) and is worth further careful investigation because of the time and cost savings (e.g., no need to use PRCs) that could be gained in some *in situ* passive sampler applications. However, it is critical that target contaminant equilibrium is demonstrated before this PRC-free approach is used *in situ* otherwise  $C_{\text{free}}$  may be underestimated resulting in an underestimation of exposure. PRCs are not used with DGT passive sampling and risk.

## 6.2 Using Performance Reference Compounds (PRCs)

### 6.2.1 Selecting PRCs

It is very important to avoid adding PRCs to the passive sampler that the analytical laboratory is using as surrogate (i.e., recovery) or injection standard (see Section 7). One subset of compounds should be used as PRCs, while reserving others for use as surrogate (recovery) compounds. Still other compounds

such as terphenyl for PAHs can be used as injection standards. While the process for choosing the appropriate PRCs for PCBs and PAHs is fairly clear, selecting PRCs for some sediment contaminants can become complicated. For example, the organochlorine pesticides DDT has been shown to degrade relatively quickly to form DDE or DDD under certain environmental situations. Given this, one should use the 4,4'- isomer of  $^{13}\text{C}$ -labelled DDT and the 2,4'-isomers of DDE and DDD as PRCs to allow the appearance of  $^{13}\text{C}$ -labelled 4,4'-DDE or 4,4'-DDD to be interpreted as arising from the degradation reaction of the  $^{13}\text{C}$ -labelled DDT PRC during the deployment.

Most often PRCs are selected because they share similar physiological characteristics (e.g., diffusion [based on molar volume and surface area]), with the target contaminant (Fernandez et al. 2009a; Huckins et al. 2002). In addition, the analytical instrumentation may be a selection factor. PRCs suitable for measurement using GC/MS include stable isotope-labeled (e.g.,  $^{13}\text{C}$ , or deuterated ( $\text{D}_x$ )) forms of the target contaminants of interest (e.g., PCBs and PAHs). Another class of PRCs exclusively for use with PCBs and quantifiable via GC/ECD, as well as GC/MS, are the rare PCB congeners (Tomaszewski and Luthy 2008) (Table 6-1). However, care must be taken when using the rare PCB congeners as PRCs. Such rare PRCs must be completely separated from target PCBs during GC analysis and/or their mass spectra do not include ions with mass-to-charge ratios ( $m/z$ ) that overlap with quantitation or confirmatory ions of co-eluting congeners. Another critical assumption when using them is that the rare congener does not occur in the environment due to prior contamination. Unfortunately, several studies have found that this assumption was not correct and the rare PCB congener was unusable as a PRC. In addition, gas chromatography may have difficulties separating all congeners in a sample from one another including the rare

congeners. Table 6-1 lists some common PRCs. These types of PRCs are commercially available from vendors including:

Accustandard (New Haven, CT, USA  
<http://www.accustandard.com/>);

Cambridge Isotopes Laboratory, Inc.  
(Tewksbury, MA, USA  
<http://www.isotope.com/>);

Qmx Laboratories (Thaxted, Essex, CM6 2PY  
UK <http://www.qmx.com/>);

Sigma Aldrich (St Louis, MO, USA  
<https://www.sigmaaldrich.com/>);

UltraScientific (North Kingstown, RI, USA  
<http://www.ultrasci.com/globalhome.aspx>);

Wellington Laboratories Inc. (Guelph, Ontario,  
Canada <http://well-labs.com/>).

### 6.2.2 Loading PRCs

The process for loading PRCs into a passive sampler polymer involves soaking the sampler in a volume of water or a methanol:water solution (80:20) (Booij et al. 2002) containing the PRCs (Figure 6-1). Performing this procedure in a glass bottle allows for the PRC solution to be “plated” on the glass wall, and the solvent to evaporate. The water (or methanol:water) is then added to the bottle, followed by the passive sampler(s). This approach avoids the PRC and organic solvent in which it is generally prepared (e.g., heptane, nonane) from forming a third phase in the water. The bottle(s) can then be closed and placed on a mixer (e.g., orbital shaker) to expedite the PRC loading process. Sufficient PRC equilibration time during this passive sampler preparation step is necessary to ensure uniform loading of the PRC across the entire polymer thickness. Therefore, while thicker passive samplers (e.g., LDPE or POM) are more robust for field use, it takes longer to load them with PRCs. Methanol added to the water



(e.g., 80:20 methanol:water) swells the passive sampler polymer to some extent, and equilibration takes somewhat less time than the water-only solutions (Booij et al. 2002).

Loading with PRCs using methanol:water has been applied with all three types of samplers (e.g., Perron et al. 2013a, 2013b, Thomas et al. 2014). However, such loading requires soaking the passive sampler in water to remove methanol after the PRC addition. If the PRCs were loaded from methanol:water solution, just before deployment, the PRC-loaded passive sampler is rinsed with high quality water, and then it is soaked in high quality water for 24 hours to remove methanol from the polymer. This methanol removal step is repeated twice to ensure complete methanol removal.

Equilibration times also vary for different PRC/passive sampler thickness combinations and the passive sampler to water phase ratio. For PAHs and PCBs in aqueous solution, at least a 30-day duration is needed to ensure homogeneous distributions of the PRCs throughout the entire thickness of the LDPE film, unless faster equilibration has been confirmed. Equilibration times from methanol:water solutions are typically completed within seven days (Booij et al. 2002). Confirmation of PRC loading equilibration can be performed by time course measures of PRC concentrations in the polymer

or by showing that concentrations of PRCs are the same for films of different thicknesses but the same masses. Once loaded with PRCs the samplers generally are stored in the PRC solution until shortly before deployment. It is critical to retain at least one (i.e., replicates are recommended) sample of PRC that is loaded in a passive sampler but not deployed. This passive sampler will be analyzed to determine the initial PRC concentrations in the polymer (PRC<sub>i</sub>) for later analysis. Ideally, replication of the undeployed passive sampler would match the replication used in the deployment design. For example, if three passive samplers were deployed at each field station, or three replicate chambers were used in the laboratory, then unique pieces of three passive sampler polymers would be prepared to determine PRC<sub>i</sub>.

While the medium and high K<sub>OW</sub> PRCs are relatively stable once accumulated by the passive sampler polymer, low K<sub>OW</sub> PRCs may start to exit the polymer via volatilization once they are removed from the PRC-loading solution. If the purpose of a deployment is focused on low K<sub>OW</sub> target contaminants (e.g., naphthalene) using low K<sub>OW</sub> PRCs, it is advisable to analyze sub-samples of the samplers to determine how much PRC has been lost prior to deployment.

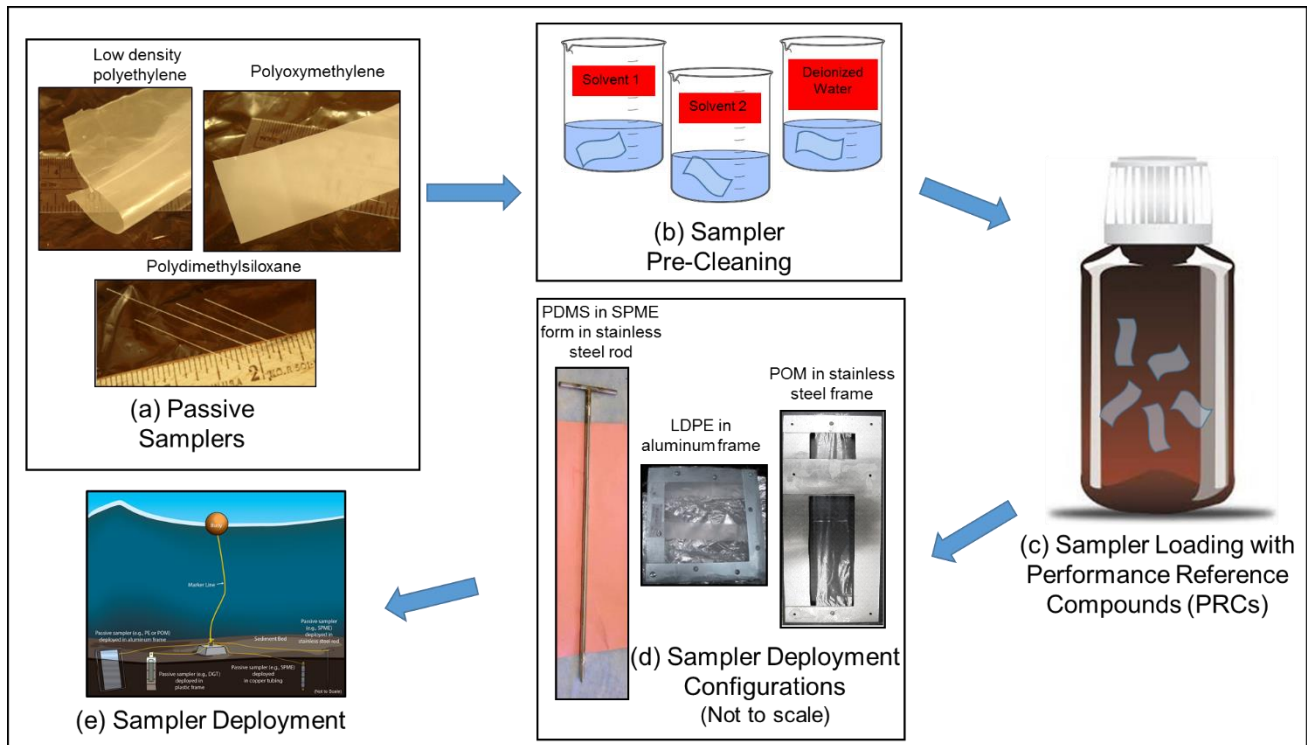

**Figure 6-1. Sequence of steps used to prepare passive samplers for field deployment: (a) selection of passive samplers; (b) pre-cleaning of samplers with organic solvents and deionized water; (c) loading of passive samplers with performance reference compounds (PRCs); (d) configuration of passive samplers for field deployment; and (e) deployment of passive samplers in the field (See also Figure 1-5).**

**Table 6-1. Example<sup>a</sup> performance reference compounds (PRCs), as well as surrogate standards (internal standards), and injection standards for different classes of contaminants when using low density polyethylene (LDPE) passive samplers.**

Target Contaminant	Performance Reference Compounds (PRCs)	Surrogates/Internal Standards	Injection Standards
Polycyclic aromatic hydrocarbons (PAHs)	D <sub>10</sub> -phenanthrene D <sub>10</sub> -pyrene D <sub>12</sub> -chrysene	D <sub>10</sub> -anthracene D <sub>10</sub> -fluoranthene D <sub>12</sub> -benz(a)anthracene	D <sub>10</sub> -acenaphthene D <sub>14</sub> - <i>m</i> -terphenyl D <sub>12</sub> -perylene
Polychlorinated biphenyls (PCBs)	<sup>13</sup> C <sub>12</sub> CB-28 <sup>13</sup> C <sub>12</sub> CB-52 <sup>13</sup> C <sub>12</sub> CB-101 <sup>13</sup> C <sub>12</sub> CB-153 <sup>13</sup> C <sub>12</sub> CB-180	<sup>13</sup> C <sub>12</sub> CB-19 D <sub>6</sub> CB-77 D <sub>5</sub> CB-116 CB-198 <sup>13</sup> C <sub>12</sub> CB-105 <sup>13</sup> C <sub>12</sub> CB-167 <sup>13</sup> C <sub>12</sub> CB-170 <sup>13</sup> C <sub>12</sub> CB-194	D <sub>6</sub> CB-77 D <sub>5</sub> CB-116
DDTs	2,4'-DDD 2,4'-DDE <sup>13</sup> C <sub>12</sub> 2,4'-DDD <sup>13</sup> C <sub>12</sub> 4,4'-DDT	CB-111 <sup>13</sup> C <sub>12</sub> CB-153 <sup>13</sup> C <sub>12</sub> 2,4'-DDT	D <sub>6</sub> CB-77 <sup>13</sup> C <sub>12</sub> CB-105 <sup>13</sup> C <sub>12</sub> CB-167

<sup>a</sup> This example assumes that gas chromatography/mass spectroscopy is the analysis method with detection limits of approximately 100 – 200 pg/100 mg LDPE.

### 6.2.3 Determining the Quantity of PRC to Load into Passive Samplers

To determine how much PRC should be loaded into a passive sampler for laboratory (*ex situ*) or field deployments (*in situ*), one should first estimate the expected concentration of the target contaminants in the sampler post-deployment. This estimate can be based on historical water or sediment interstitial water data or modeling interstitial water concentrations using equilibrium partitioning and measured sediment target contaminant concentrations. Following deployment, target contaminants and PRCs should have comparable concentrations, so that if dilution or further extract concentrating is necessary for analytical reasons, quantification of both the targets and PRCs is possible in the same analysis. Also, it is important to ensure that depleted PRC concentrations will be

quantifiable, given the sampler size and final extract concentrations. For example, if PRCs are loaded at 0.50 µg/g to a one gram passive sampler, it is important to make certain, given instrument detection limits, that it is possible to quantify 0.05 µg/g (i.e., ~50 ng/mL for 1 mL final extract volume, or ~25 ng/mL for a 0.5 g-sampler in a one milliliter final extract volume), in the event that 90% of a given PRC is depleted. In this instance, if concentrations of the target contaminants are on the order of 50 µg/g, it may be difficult to accurately quantify the loss of the PRCs and use them to adjust for equilibrium concentrations of target contaminants.

Once the loaded PRC concentration in the passive samplers and the number of samplers to be loaded have been determined, a loading or spiking solution volume and concentration can be calculated. First, determine the volume of

loading solution that is needed. Note that exceeding a 0.03 g polymer/mL loading solution ratio can result in problems with physically getting all of the polymer into the loading solution. Once the mass of PE and volume of loading solution have been determined, then the concentration necessary to load into the samplers can be estimated. First, determine the equilibrium concentration of each PRC in the loading solution, based on that PRC's concentration as needed in the passive sampler using the same partitioning approach applied to determine  $C_{\text{free}}$  from  $C_{\text{PS}}$  (based on Equation 1-3). The total amount of PRC needed can be determined by summing the mass of PRC in both the passive sampler polymer and the loading solution at equilibrium. To calculate the mass in the polymer, divide the equilibrium concentration by the total mass of polymers to be pre-loaded, and to calculate total mass in the loading solution, divide the solution's concentration by the total volume. If loading with a methanol/water solution (as opposed to just water), methanol:water partitioning coefficients ( $K_{\text{MS}}$ ) for LDPE and PDMS are given by Booij et al. (2002). To estimate  $K_{\text{MS}}$  for compounds not measured by Booij et al. (2002), an estimation can be performed by correlating the log  $K_{\text{OW}}$  to the log  $K_{\text{MS}}$  given in the same publication. Note that  $K_{\text{MS}}$  is not presented as a log value (Booij et al. 2002), and the units are mL/g.

To load the PRCs into the sampler, first prepare the loaded PRC solution. Make sure that the container in which you intend to load the samplers is sufficiently large for both the samplers and the loading solution. Once the PRC solution is ready, add the samplers one at a time, eliminate air bubbles on the polymers, and maximize the sampler solvent contact until all samplers are submerged in the loading solution. If there is a significant amount of headspace in the container, consider adding more solvent (i.e., water or methanol:water) —

although this will lower your spiking concentrations somewhat. Seal the container with a watertight, ground glass stoppered lid, and protect the solution from light (either in amber glass or cover with foil). To accelerate the loading process, place the container on an orbital shaker to agitate the loading solution and enhance transfer of PRCs into the passive sampler polymer. Generally, the loading period will be at least as long as the deployment period. As noted, if using the methanol:water solution to load the passive samplers, this solution causes the polymer matrix to expand, allowing faster loading, and the process will take less time than using a high quality water loading solution. However, one must plan on a day or two to leach methanol from the passive sampler before deployment. Once the loading process is complete, the samplers can be left in the loading solution (for water) or the leaching solution (for methanol-water) in the dark until the laboratory or field deployment. The time necessary to load the PRCs into a passive sampling polymer such that they reach equilibrium can be estimated using diffusion modeling but requires some sophistication and acquiring assistance from one of the technical contacts listed in Table 1-4 is highly recommended.

#### 6.2.4 Example Calculation

The following example describes (i) how much PRC to load into a given passive sampler, (ii) the amount of PRCs to add to the batch of samplers being deployed together, and (iii) the loading solution volume and concentrations of PRCs. The example assumes that the loading solution is pure water and not a solution containing a mixture of water and methanol. To load passive sampler polymers with PRCs in a water:methanol solution, see the methodology discussed in Booij et al. (2002).

In this simple example, based on equilibrium partitioning modeling, interstitial waters at a contaminated sediment site are

expected to have concentrations of PCB congener 52 (CB52) at about 10 ng/L interstitial water. Rearranging Equation 1-3, we can estimate the concentration of CB52 that would accumulate in a one kilogram LDPE:

$$C_{LDPE} = K_{LDPE} * C_{free} \quad [6-1]$$

where, the  $K_{LDPE}$  for CB52 is 354813 L/kg LDPE (Appendix A), and  $C_{free}$  is set equivalent to an equilibrium partition based estimate of 10 ng/L for the interstitial water concentration. In this case,  $C_{LDPE}$  is  $3.55 \times 10^6$  ng/kg LDPE, or 3.55  $\mu\text{g/g}$  LDPE. Given this result, the samplers will be loaded with 3.55  $\mu\text{g/g}$  LDPE using the PRC  $^{13}\text{C}$  CB52 (i.e., the best PRC for CB52). If during the deployment, the PRC is depleted by 90%, there would still be 0.355  $\mu\text{g/g}$  LDPE in the sampler, which is well above the equivalent instrumental detection limit for CB52 using GC/MS (i.e., for this example, 3550 ng/mL versus the detection limit of 50 ng/mL) using a LDPE density of 0.92 g/mL.

Next, the loading solution will be 2000 mL for 50 g of LDPE samplers ( $n = 50$  individual passive samplers are to be deployed). Again using Equation 1-3, modified for LDPE, the sampler loading solution concentrations can be determined:

$$C_{free} = \frac{C_{LDPE}}{K_{LDPE}} \quad [6-2]$$

Now,  $C_{free}$  is set equal to the loading solution concentration of the PRC  $^{13}\text{C}$  CB52, and  $C_{LDPE}$  is the 3.55  $\mu\text{g}$  of PRC  $^{13}\text{C}$  CB52 /g LDPE calculated above. Here, the loading solution concentration is determined to be 10  $\mu\text{g/L}$  loading solution. Given the results of this calculation and the volume of loading solution (2000 mL), 197.5  $\mu\text{g}$  of PRC  $^{13}\text{C}$  CB52 will be needed for preparing the loading solution. One vendor, Cambridge Isotope Laboratories, Inc.,

offers  $^{13}\text{C}$  CB52 in 40  $\mu\text{g/mL}$  organic solvent units of 1.2 mL or 3.0 mL which can be used to prepare the loading solution. For this example, 5 mL of the vendors  $^{13}\text{C}$  CB52 is required to prepare the loading solution.

#### 6.2.5 Chemical Analysis of PRCs following Deployment

Following recovery of the passive samplers, instrumental chemical analysis of the PRCs is performed as part of the analysis of the target contaminants (see Section 7). During the data analysis (Section 8), the post-deployment concentrations of the PRCs are determined ( $C_{PRC(f)}$ ). In addition, the sample from the non-deployed passive sampler is also analyzed to determine the initial concentration of PRCs ( $C_{PRC(i)}$ ) in the passive samplers. These two values are used to calculate the measured fraction of each PRC ( $f_{eq}^{mPRC^x}$ ) lost from the sampler section during its deployment (see Equation 8-3). As noted above, analyses would be performed in an effort to match the replication used in the field or laboratory deployments.

## Section 7

# Extraction and Instrumental Analysis of Target Contaminants from Passive Sampling

## 7.1 Introduction

Following deployment and storage of the passive samplers, chemical analysis is the next step in their processing. This part of the process is addressed in two steps in this section: first, the extraction of target organic contaminants and metals from the passive sampler polymer, and second, the actual instrumental chemical analysis of the resulting extracts (Table 7-1). Neither of these exercises is overly difficult. For example, extraction of the passive samplers is, in most cases, simpler than extracting sediments, soils, or tissues. However, the extraction procedures are not yet commonly performed in commercial laboratories, so they will be described here in detail (Figure 7-1).

Ideally, the POM and LDPE passive samplers deployed *in situ* will arrive refrigerated at the analytical laboratory in glass jars generally in coolers. The size of the jars will depend on the objectives of the investigation but will likely range from 20 mL to four liters in volume. The PDMS passive samplers deployed *in situ*, in the form of SPME fibers, will also arrive at the analytical laboratory in glass jars refrigerated but because of the SPME's small size, the jars will most often range in volume from 2 to 20 mL. For POM, LDPE and PDMS, the storage/transport jars should use clean foil as a lid liner (not a plastic polymer [e.g., Teflon]). The POM and LDPE films and SPME fibers can be processed in the field by the addition of organic solvent to

the glass jars holding the retrieved passive samplers. This initiates the extraction and reduces the loss of volatile target contaminants during transport and storage. It is extremely critical to confirm that vials and jars are firmly sealed and that solvent will not leak during transport. If the samplers require extensive cleaning at the laboratory, they should not have solvent added to them in the field. In addition, if the passive sampler cannot be processed in the field or upon arrival at the laboratory (which is recommended), they should be stored at or below 4.0 °C in the dark until processing can be started.

After recovery, the DGT samplers should be rinsed with deionized water prior to placement in a clean plastic bag. A few drops of deionized water is added to the interior of the bag to maintain moist conditions and prevent drying. When the DGT samplers arrive at the analytical laboratory they should be refrigerated (~4.0 °C) in the dark in the same plastic bag (but not frozen).

Regarding the instrumental chemical analysis, once extracted and reduced to an organic solvent extract for organic target contaminants, or an acid extract for target metal contaminants, the chemical analysis is identical procedurally and cost-wise to a water, sediment, soil, or tissue analysis. In fact, the passive sampler extracts may be easier to analyze because the polymers generally don't

require the degree of clean-up needed by sediment, soil, and tissue extracts. For organic target contaminants, one difference from conventional extracts and analyses, as discussed in Section 6, is that the passive sampler extracts may contain performance reference compounds that will need to be added to the analyte list of the analytical instrumental method.

Further, as with the rest of this document, the target contaminants consists of the conventional legacy pollutants, including the hydrophobic organic contaminants, polychlorinated biphenyls (PCBs) and polycyclic aromatic hydrocarbons (PAHs), and metals (e.g., cadmium, copper, nickel, lead, zinc). In part, this is because the extraction and analytical methods have been developed and standardized for these contaminants, and these methods can be revised easily for use with passive samplers. Further, these are the

classes of contaminants that occur at many contaminated sites around the country and drive monitoring and remediation efforts. As noted earlier, for organic target contaminants, other classes of contaminants can be measured with the assistance of passive sampling, including chlorinated pesticides such as DDT and its degradation products and the chlorinated dioxins and furans. However, data needed for the passive sampling of these target contaminants, like partition coefficients and analytical methods, are not readily available at present. This is not to suggest that methods for other classes of contaminants, including contaminants of emerging concern, are not available for use with passive samplers (e.g., Perron et al. 2013b). However, in many cases, greater method development would likely be needed, because standardized methods may not have been fully established.

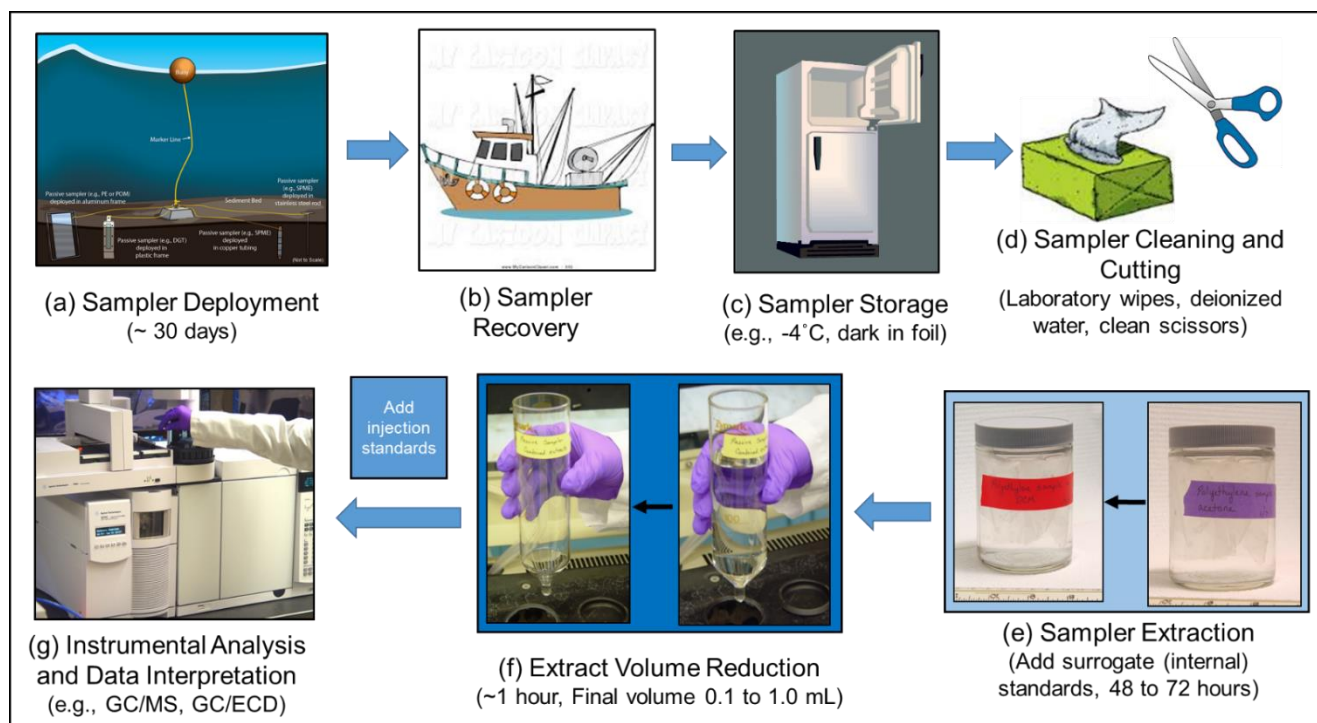

**Figure 7-1. Illustration of basic steps involved in preparing an *in situ* deployed passive sampler (e.g., LDPE) for extraction and instrumental chemical analysis for hydrophobic organic target contaminants: (a, b) conclude deployment (see also Figure 1-5) and recover samplers; (c) store and ship samplers on ice or refrigerated in closed glass vessels to the laboratory; (d) remove adhering sediment and biological growth using laboratory wipes and deionized water, and cut samplers to desired sizes for extraction; (e) at the laboratory, add surrogate standards (also called internal standards) and extraction solvent(s); (f) volume reduce solvent and add injection standards; and (g) analyze via gas chromatography/mass spectroscopy (GC/MS) or gas chromatography/electron capture detection (GC/ECD). *Ex situ* deployments are similar but steps A and B are performed in the laboratory.**



**Table 7-1. Summary of extraction and analytical methods for passive samplers discussed in this section including U.S. EPA methods for analyzing PCBs, PAHs, and metals, as well as other selected contaminant classes.**

<b>Target Contaminant</b>	<b>Passive Sampler</b>	<b>Extraction</b>	<b>Contaminant Class</b>	<b>Analytical Methods</b>
Hydrophobic Organic Contaminants	POM, PDMS, LDPE	Organic solvents (acetone, hexane, acetonitrile, methylene chloride)	Polycyclic aromatic hydrocarbons	Method 8310: HPLC Method 8270D or 8270-Selecting Ion Monitoring: SVOCs by GC/MS
			Polychlorinated biphenyls	Method 8082A: GC/ECD or GC/ECD Method 1668c: HRGC/HRMS Method 8270-Selected Ion Monitoring: GC/MS
			Chlorinated pesticides	Method 1699: Pesticides by HRGC/HRMS Method 8081B: Organochlorine pesticides by GC Method 8270D or 8270-Selected Ion Monitoring: SVOCs by GC/MS
			Polychlorinated dibenzodioxins/ Polychlorinated dibenzofurans	Method 8280B: HRGC/LRMS Method 8290A: HRGC/HRMS Method 1613B: HRGC/HRMS
Metals	DGT	Inorganic acids (Nitric acid)	Cadmium, copper, nickel, lead, zinc	Method 6020A (also APHA Method 3125): ICP-MS

## 7.2 Extraction for POM, PDMS, and LDPE

The general extraction procedure is basically the same for each type of passive sampler discussed in this document. Once received by the analytical laboratory, each type of passive sampler is amended with surrogate standards (also called internal standards) chosen to complement the target contaminants of interest to assess target analyte recoveries (see Table 6.1). Subsequently, the samplers are each submerged in a suitable solvent (e.g., methylene chloride) for at least 12 hours. A shaker table or some other suitable mechanical agitation is recommended for the extractions, to facilitate sampler-solvent contact and target contaminant transport. The extract is transferred to a large vessel suited for solvent evaporation, and then the sampler is re-extracted two more times with organic solvent, with the extracts combined for evaporative volume reduction, and eventual gas chromatography/mass spectroscopy (GC/MS) (or suitable) instrumental analysis. After the extraction, the sampler is air-dried and weighed. Before analysis, appropriate injection standards are added to the final extracts to allow for evaluation of the injection efficiency.

For strongly hydrophobic and low volatility target contaminants, there will be limited loss from polymers even if processing is conducted after shipment to a laboratory. For low hydrophobicity, volatile target contaminants, however, immediate processing may be necessary to minimize the losses. Volatile compounds such as naphthalene or similar should be processed rapidly in the field (i.e., transferred to a vial containing organic solvent) and tested for volatile losses from the thickness and sorbent employed. For example, substantial volatilization of naphthalene from 30  $\mu\text{m}$  thick PDMS exposed directly to the air occurs on the order of minutes (Reible and Lotufo 2012). Retention is maximized by using a thicker polymer or polymer with a

greater affinity for the target contaminant or by focusing on less volatile target contaminants. Evaporative losses can also be minimized by placing samplers in a sealed bag and cooling for shipment to the laboratory. For example, phenanthrene losses from 30  $\mu\text{m}$  PDMS were negligible over 24 hours when prepared in this manner (Reible and Lotufo 2012). Adding a small volume of deionized water will also limit volatilization.

The affinity for many target contaminants to the extraction solvents such as hexane, methanol, or acetonitrile is equal to or stronger than that of the polymers, and thus, extraction is complete as long as the volume of extraction solvent is much greater than the volume of polymer. For example, typically less than 1–10  $\mu\text{L}$  of PDMS sorbent is employed in a sample, so extraction with 10–100  $\mu\text{L}$  of solvent is sufficient to insure essentially complete extraction.

### 7.2.1 Extraction of POM

Text Box 7.2 provides a detailed description of the steps involved for the extraction of POM for PCBs and PAHs.

### 7.2.2 Extraction of PDMS

Text Box 7.1 provides a detailed description of the steps involved for the extraction of PDMS for PCBs and PAHs. For this description, the PDMS is assumed to be associated with an SPME fiber, rather than in a sheet configuration. If the PDMS is deployed in a sheet configuration, the polymer will be extracted in a similar way as POM and LDPE.

**Text Box 7-1. Outline of example procedures for extracting PAHs and PCBs from POM.****Extraction Procedure**

**Preliminary: After field or laboratory deployment, carefully remove sampler polymer from any deployment gear and clean by wiping with laboratory wipes**

1. The POM film is inspected for surface biofilms, particles, mud, oily coatings, and other residues. Biofilm mass should be removed using a clean wipe followed by a rinse with deionized water. Sedimentary debris is removed by rinsing with deionized water and careful surface scraping with a razor if necessary to remove adhered/embedded material. Oily coatings (e.g., hydrocarbon slicks) are removed by soaking clean wipes in hexane and using forceps to wipe both POM surfaces. This is a rapid and non-exhaustive rinsing performed immediately prior to immersion in organic solvent for the actual extraction. To limit the presence of water, POM surfaces are blotted dry if necessary.
2. To start the extraction, use clean, labeled, glass vials, one for each POM strip. The size of the polymer strips will vary depending on the expected concentration of target contaminants. For example, samplers exposed to sediment interstitial water will be smaller than samplers deployed in the water column. Add sufficient acetone/hexane (1:1 by volume) to each vial to completely submerge the POM strips. Use pesticide residue-grade solvents.
3. Add surrogate solution to each extraction vial (e.g., 30  $\mu\text{L}$  of 500  $\mu\text{g/L}$  of selected PCB congeners and PAH molecules added to 40 mL vial). Surrogate standard is also called internal standard. It is critical to avoid using surrogate (internal) and injection standards that may co-elute or interfere with performance reference compounds (PRCs) as discussed in Section 6.
4. Transfer each POM strip to one of the vials. Tightly cap the vials using Teflon-line caps.
5. Place POM extraction vials on an orbital shaker running at 30 rpm. Cover or use amber vials to prevent photo-degradation of light sensitive target contaminants. Note the time.
6. After a 24-hour extraction period, remove the vials from the shaker.
7. Prepare clean, labeled glass vials with a capacity approximately three times that of the extraction vials, one for each POM strip. From each of the extraction vials, transfer the solvent extract, but not the POM strip, to its corresponding large capacity vial. Cap, wrap (to reduce photodegradation), and freeze the vials.
8. Add fresh acetone/hexane (1:1 by volume) to each of the extraction vials still containing the POM strips. Cap, wrap, cover to prevent photodegradation, and place on the shaker for another 24 hours.
9. After the second 24-hour extraction, transfer the liquid extract of each strip to the corresponding large capacity vial containing the first day's extract (i.e., combine the first and second extracts of each strip). Cap, wrap, and freeze the large capacity vials.
10. Perform the third and final extraction by repeating steps 7 and 8.
11. Allow the extracted POM strips to dry, and record their weights using an analytical balance. This result is used to calculate the final target contaminant concentrations measured in the POM sampler in units of contaminant mass per POM mass (e.g., ng/g POM).
12. Using rotary evaporation or equivalent volume reduction equipment, reduce the final extracts in the large capacity vials and proceed with sample clean-up (if necessary) and instrumental analysis for selected PCB congeners and PAHs. The final volume will depend on the specific laboratory procedures: 1 to 2 mL is recommended.

**Extraction Procedure**

13. The solvent extracts are stored at -4°C in the dark until ready for instrumental analysis.
14. Before analysis, appropriate injection standards are added to the final extracts to allow for evaluation of losses during the injection and instrumental analysis (Table 6-1).

**Text Box 7-2. Outline of example procedures for extracting PAHs and PCBs from PDMS.****Extraction Procedures**

**Preliminary: The following description is for a modified push point sampler used in a field deployment applying SPME fibers (not PDMS sheets). However, the basic procedures are applicable to laboratory deployed PDMS samplers or field deployed PDMS samplers using configurations other than the push point sampler**

1. After removal from the field, the sampling device's inner rod is separated from the outer sheath. The SPME PDMS fiber is carefully removed from the inner rod using a single-edge razor, and adhering sediment, particles, biofilm, and any residue is removed from the SPME PDMS fiber using deionized water-wetted laboratory wipes. SPME PDMS fibers are then blotted dry before segmentation.
2. Laboratory and/or field blank and field-deployed SPME PDMS fibers are segmented, using a ceramic column cutter into predetermined lengths at points along the SPME PDMS fiber, which correspond to specific depths of interest from the sediment-water interface.
3. The SPME PDMS fiber segments are transferred to 2-mL glass amber vials (i.e., auto-sampler vials) that contain a 300- $\mu$ L glass vial insert. The inserts should be prefilled with the appropriate solvent (e.g., acetonitrile for PAHs, hexane for PCBs). The solvent volume should be sufficient for the complete immersion of the SPME PDMS fiber segment. Add surrogate standard to each 300  $\mu$ L glass vial insert.
4. The SPME PDMS fiber segments are left in the solvent for 12 to 24 hours and stored at -17°C until analysis. During transportation, the samples are kept at a temperature not to exceed 4°C.
5. The SPME PDMS fiber segments are removed from the solvent before analysis to avoid interference with the analytical equipment's injection needle.
6. The SPME PDMS fiber segments are allowed to dry and weighed using an analytical balance. This result is used to calculate the final target contaminant concentrations measured in the PDMS sampler in units of contaminant mass per PDMS mass (e.g., ng/g PDMS). For a given type of fiber, the volume and mass of the PDMS coating per unit length are known.
7. The solvent extracts are stored at -4°C in the dark until ready for instrumental analysis.
8. Before analysis, appropriate injection standards are added to the final extracts to allow for evaluation of losses during the injection and instrumental analysis (Table 6-1).

Unlike POM and LDPE, when used in the SPME configuration, PDMS can also be extracted by direct injection into a gas chromatograph's injection port. In this approach, the SPME fiber is inserted into the heated injection port, and the target contaminants evaporate directly from the fiber and enter the gas chromatographic column. This approach allows the entire mass of target contaminant to be extracted from the fiber during instrumental analysis at once, rather than a fraction of the mass as occurs when using conventional solvent extraction as described above. Consequently, the direct injection approach can result in much greater instrumental sensitivity for target contaminants. For example, estimated increases in instrumental sensitivity range from a factor of 10 to higher. This technique also results in the use of less organic solvents which is both an environmental sustainability and cost-savings goal. However, aspects of direct injection are not as well established as with conventional solvent extraction methods. For example, standards are analyzed via an external

calibration, rather than the more common and established internal calibration. In addition, in general, with direct injection, the samples are loaded into the instrument manually, unless an automated direct injection device is available.

While autosamplers are common for conventional injection loading of organic solvent extracts, autosamplers for direct injection are less common. In addition, the use of the direct injection technique may result in the increased loss of volatile target contaminants (e.g., naphthalene). Finally, with direct injection, if the analysis fails for any reason (e.g., instrumental error), the entire sample is lost; whereas with conventional solvent extracts, there frequently is more extract remaining that can be used.

### 7.2.3 *Extraction of LDPE*

Text Box 7.3 provides a detailed description of the steps involved for the extraction of LDPE for selected PCBs and PAHs.

**Text Box 7-3. Outline of example procedures for extracting PAHs and PCBs from LDPE.****Extraction Procedures**

**Preliminary: After field or laboratory deployment, carefully remove sampler polymer from any deployment gear and clean by wiping with laboratory wipes**

1. The LDPE film is inspected for surface biofilms, particles, mud, oily coatings, and other residues. Biofilm mass should be removed using a clean wipe followed by a rinse with deionized water. Sedimentary debris is removed by rinsing with deionized water and careful surface scraping with a razor if necessary to remove adhered/embedded material. Oily coatings (e.g., hydrocarbon slicks) are removed by soaking clean wipes in hexane and using forceps to wipe both LDPE surfaces. This is a rapid and non-exhaustive rinsing performed immediately prior to immersion in organic solvent for the actual extraction. To limit the presence of water, LDPE surfaces are blotted dry if necessary.
2. The LDPE is transferred to a pre-cleaned amber vial or bottle (size determined by dimensions of LDPE, typically 15–40 mL). Vials or bottles must be large enough for complete immersion of LDPE without excessive LDPE folding.
3. Known masses of surrogate compounds (also known as internal standard) (Table 6-3) in a methylene chloride compatible solvent are added to the vial or bottle. Typical additions are: 2.5–20 ng for aqueous samples and 50–250 ng for sediment samples, depending on target contaminants and their expected concentrations in the LDPE.
4. Methylene chloride is added to the vial to completely submerge the LDPE for a period of at least 12 hours.
5. The extract is transferred to a pre-cleaned glass concentration vessel leaving the passive sampler in the first vial. A second aliquot of methylene chloride is added to the extraction vial and agitated for >10 minutes. This step is repeated two more times with extracts being composited.
6. After the final extract transfer, the LDPE is allowed to air dry in the extraction vial and weighed on an analytical balance until a consistent LDPE mass is obtained. This result is used to calculate the final target contaminant concentrations measured in the LDPE sampler in units of contaminant mass per LDPE mass (e.g., ng/g LDPE).
7. Extracts are concentrated using rotary evaporation (or equivalent) down to suitable volumes for GC/MS analysis; the resultant concentrated extracts are transferred to smaller vials (e.g., for autosamplers) according to standard laboratory analytical practices.
8. The solvent extracts are stored at -4°C in the dark until ready for instrumental analysis.
9. Before analysis, appropriate injection standards are added to the final extracts to allow for evaluation of the total volume of extract analyzed (Table 6-3). Typical final extract volumes are 50–250 µL for water column–exposed LDPE and 1–10 mL for sediment-exposed LDPE.

### 7.3 Instrumental Chemical Analysis for POM, PDMS and LDPE

In general, once the passive sampler-based extracts have been generated, they can be analyzed for target contaminants using standard U.S. EPA methods (Table 7-1). Table 7-1 provides a tabulation of standard U.S. EPA methods by class of contaminants. However, for PCB analyses, only congener-level analysis can be used to convert polymer concentrations to  $C_{free}$ . Consequently, methods including SW846 Method 8082 (GC/ECD) for quantifying Aroclors and SW846 Method 8270/U.S. EPA Method 608 (GC/MS) for quantifying PCB homologs should not be used for passive sampler analyses. Although the standard methods listed in Table 7-1 are more frequently used by research and commercial laboratories, any method appropriate for the target contaminants and capable of analyzing a concentrated sample of extract can also be successfully employed.

One additional consideration for passive sampler extracts is the presence of performance reference compounds (PRCs) used to adjust measured passive sampler concentrations for non-equilibrium conditions (see Section 8). Use of PRCs means that the instrumental analytical method developed and applied by a research or commercial laboratory will need to include these PRCs in their calibration standards. Similarly, it is also important to select PRCs that will not interfere with the analysis of the surrogate (internal) and injection standards.

#### 7.3.1 Instrumental Detection Limits for POM, PDMS and LDPE

The minimum method detection limits (MDLs) for POM, PDMS, and LDPE are determined by three main factors: (1) final analytical detection limits, (2) mass of polymer used for sampling, and (3) partition coefficients for the selected polymer. These factors are expressed in the following equation series:

$$MDL = \frac{C_{Polymer\ DL}}{K_{PS}} = \frac{n_{Detection}}{V_{PS} * K_{PS}} = \frac{C_{WDL} * V_S}{V_{PS} * K_{PS}} \quad [7-1]$$

where,  $C_{Polymer\ DL}$  is the detection limit for the passive sampler concentration ( $\mu\text{g/g}$  polymer),  $K_{PS}$  is the passive sampler-water partition coefficient,  $n_{Detection}$  is the mass of contaminant detected ( $\mu\text{g}$ ),  $V_{PS}$  is the volume of the passive sampler polymer (mL),  $C_{OS}$  is the concentration in the organic solvent ( $\mu\text{g/mL}$  organic solvent), and  $V_{OS}$  is the volume of organic solvent (mL). Note that this equation calculates MDLs using  $K_{PS}$  in units of  $\text{mL}_W/\text{mL}_{PS}$ , which differs from the units used elsewhere in this document (e.g.,  $\text{mL}_W/\text{g}_{PS}$ ). While, the mass of polymer can be tailored to achieve a desired detection limit, the analytical detection limit and partition coefficients are determined by the properties of the target contaminant being measured. High-resolution mass spectrometry (HRMS) can provide very low detection limits but is more expensive than more commonly used analytical methods (i.e., low-resolution MS [LRMS]). For chlorinated organics, when and where possible, gas chromatography/electron capture detection (GC/ECD) provides reasonably good detection limits. Regular LRMS typically provides a factor of 5–10 higher detection limits compared to ECD for PCBs. However, as discussed in Section 6, often the optimum PRCs are the stable isotopically-labelled forms of the target contaminants (e.g.,  $^{13}\text{C}$  PCB congeners, deuterated PAH molecules). Unfortunately, the GC/ECD cannot distinguish between isotopically labelled and unlabelled PCB congeners and should not be used with these PRCs. In some cases, detection limits are reported along with log  $K_{ow}$  values for the chemical being discussed. For many of these

chemicals, the  $K_{ow}$  was determined using the SPARC program (<http://archemcalc.com/sparc-web/calc>). It is critical to note that SPARC log  $K_{ow}$  values may change with updates to the SPARC software and it is critical to record the date of when SPARC was used to generate log  $K_{ow}$  values. In addition, SPARC is no longer available free of charge. Consequently, it may be unrealistic for all users to operate this estimation software. Another source of physicochemical parameters, like  $K_{ow}$ , is the U.S. EPA's EPI Suite software (<https://www.epa.gov/tsca-screening-tools/epi-suite-estimation-program-interface>). This program can be downloaded free of charge, is gaining usage by the passive sampling community, and represents a viable alternative to using SPARC. Finally, Equation 7-1, is calculating MDLs under equilibrium conditions, when using PRCs to adjust for non-equilibrium conditions, the MDLs will be effectively raised.

### 7.3.1.1 Detection Limits for POM

Example detection limits for a range of potential target contaminants in POM and calculated practical quantitation limits (PQLs) in water are presented in Table 7-2. The MDL values for PCBs in POM are based on multiple measurements of a single PCB concentration using a GC/ECD and calculating MDL from the estimated standard deviation ( $MDL = 3.14 * \text{standard deviation}$ ). The aqueous PQL is then calculated by:  $PQL = 5 * MDL * (\text{mass of POM}) / (K_{POM})$ . For PAHs and chlorinated dioxins, the MDL is estimated based on the lowest analytical calibration standard.

### 7.3.1.2 Detection Limits for PDMS

Based on Equation 7-1, Table 7-3 summarizes the detection limits for PDMS for selected PAHs and PCBs. The detection limits are based on 2 cm segments of fiber extracted with 250  $\mu\text{L}$  of solvent in four possible configurations: (1) 1071  $\mu\text{m}$  outer diameter and 1000  $\mu\text{m}$  inner glass core diameter (1071/1000  $\mu\text{m}$ ), (2) 1060/1000  $\mu\text{m}$ , (3) 558.8/486  $\mu\text{m}$ , and (4) 230/210  $\mu\text{m}$ .



**Table 7-2. Representative target contaminant detection limits<sup>a</sup> for POM.**

Target Contaminant Class	Target Contaminant	Log K <sub>ow</sub> <sup>b</sup>	POM MDL (ng/g POM)	PQL 1g POM (pg/L)	PQL 0.2 g POM (pg/L)
PCBs	CB3	4.69	0.542	17	83
	CB6	5.06	0.05	0.37	1.8
	CB18	5.24	0.019	0.14	0.70
	CB53	5.62	0.048	0.29	1.5
	CB101	6.38	0.014	0.12	0.62
	CB153	6.92	0.011	0.05	0.23
	CB180	7.36	0.03	0.16	0.81
PAHs	Naphthalene	3.41	0.2	180	890
	Acenaphthalene	4.06	0.2	63	320
	Phenanthrene	4.74	0.2	13	63
	Anthracene	4.69	0.2	10	50
	Pyrene	5.25	0.2	5.4	27
	Chrysene	5.90	0.2	0.74	3.7
	Benzo[a]pyrene	6.54	0.2	0.22	1.1
Dioxins	2,3,7,8-TCDD	7.05	0.005	0.01	0.04

<sup>a</sup> PCB detection limits are based on typical GC/ECD analysis; PAH detection limits are based on typical GC/MS analysis; TCDD detection limits are based on typical HRGC/HRMS analysis. Detection limits reported here are for general guidance—actual detection limits will depend on the instrumental analytical method used.

<sup>b</sup> PCB log K<sub>ow</sub> values from Hawker and Connell (1988); PAH log K<sub>ow</sub> values were calculated using the SPARC program (<http://archemcalc.com/sparc-web/calc>) in June 2014; 2,3,7,8-TCDD log K<sub>ow</sub> value is from Sacan et al. (2005).

### 7.3.1.3 Detection Limits for LDPE

Using GC/MS to analyze extracts of 100 mg PE samples after reducing them to volumes of 100  $\mu$ L, the minimum method detection limits (MDLs) for PAH and PCB analyses are near 1 ng/g LDPE, and the practical quantitation limits (PQLs) are ~10 ng/g LDPE (Table 7-4).

Finally, these outcomes, when combined with the K<sub>LDPE</sub> of the specific target contaminants, indicate that one can practically detect ~ 10 picogram per liter (pg/L) concentrations of contaminants such as PAHs and PCBs in surface waters and sediment interstitial waters.

**Table 7-3. Representative target contaminant detection limits for PDMS.**

Target Contaminant	Log K <sub>ow</sub> <sup>a</sup>	PDMS <sup>b</sup> MDL (pg/L)			
		(1071/1000 µm)	(1060/1000 µm)	(558.8/486 µm)	(230/210 µm)
PAHs					
Naphthalene	3.41	12900	15300	24900	215000
Fluorene	4.20	39700	47000	76400	661000
Acenaphthene	4.06	8430	9980	16200	140000
Phenanthrene	4.74	397	470	764	6610
Anthracene	4.69	1940	2300	3740	32300
Fluoranthene	5.29	740	876	1430	12300
Pyrene	5.25	40.40	47.80	77.80	673
Chrysene	5.90	110.00	131.00	212.00	1840
Benz[a]anthracene	5.85	81.60	96.60	157.00	1360
Benzo[b]fluoranthene	6.58	39.30	46.50	75.60	655
Benzo[k]fluoranthene	6.50	8.09	9.58	15.60	135
Benzo[a]pyrene	6.54	43.40	51.30	83.50	723
Dibenz[a,h]anthracene	7.39	22.90	27.10	44.10	381
Benzo[g,h,i]perylene + Indeno(1,2,3-cd)pyrene	7.04 7.09	15.20	18.00	29.3	254
PCBs					
CB18	5.24	1228	1461	2373	20514
CB28	5.67	481	572	929	8032
CB52	5.84	332	395	641	5544
CB66	6.2	151	180	293	2529
CB101	6.38	102	122	198	1708
CB77	6.35	109	130	211	1823
CB118	6.74	46.6	55.5	90.1	779
CB153	6.92	31.5	37.5	60.9	526
CB138	6.83	38.3	45.6	74.1	640
CB187	7.17	18.3	21.7	35.3	305
CB180	7.36	12.1	14.4	23.3	202
CB170	7.27	14.7	17.5	28.4	245
CB209	10.5	0.012	0.014	0.02	0.2

<sup>a</sup> PCB log K<sub>ow</sub> values from Hawker and Connell (1988); PAH log K<sub>ow</sub> values were calculated using the SPARC program (<http://archemcalc.com/sparc-web/calc>) in June 2014.

<sup>b</sup> PDMS in SPME fiber configuration: 2 cm segment extracted with 250 µL of solvent with PAH analysis by fluorescent detection (U.S. EPA Method 8310) and PCB via ECD (U.S. EPA Method 8082) or GC/HRMS (U.S. EPA Method 1668).

**Table 7-4. Representative target contaminant detection limits for LDPE.**

Contaminant Class	Target Contaminant	Log K <sub>ow</sub> <sup>a</sup>	LDPE (ng/g LDPE) <sup>a</sup>	PQL (ng/g LDPE)	PQL (expressed as a water concentration, µg/L)
PCBs	CB52	5.84	1.4	6.8	20
	CB101	6.38	2.2	11	10
	CB153	6.92	2.6	13	3
	CB180	7.36	3.2	16	2
PAHs	Phenanthrene	4.5	1	5	500
	Pyrene	5.0	1	5	100
	Chrysene	5.7	1	5	20
	Benzo[a]pyrene	6.1	1	5	5

<sup>a</sup> Detection limits were calculated using PCB log K<sub>ow</sub> values from Hawker and Connell (1988) and PAH log K<sub>ow</sub> values are from Lohmann (2012).

#### 7.4 Extraction of DGT

After recovery from the exposure system, DGTs are disassembled and cut into vertical sections at the user required resolution (minimum 1 mm). The resin-embedded gel layer is the only section of the DGT that will be included in the extraction. The sections of resin gel layer are placed into acid-cleaned plastic centrifuge tubes for extraction. 1M HNO<sub>3</sub> is added to the gel sections for 24 hours to extract any accumulated metals. The size of tube and volume of acid used in the extraction are flexible; however, sufficient volume of acid must be added to completely immerse the resin gel in acid. Typically, for a 1-cm section of DGT, a 15 mL plastic centrifuge tube is used, and 1 mL of nitric acid.

#### 7.5 Instrumental Chemical Analysis of DGT

Extracted metals from DGTs are commonly analyzed using inductively coupled plasma mass spectrometry (ICP-MS), or less frequently, inductively coupled plasma optical emission spectrometry (ICP-OES), or flame atomic absorption spectrometry (AAS) (Table 7-1). ICP-MS has the lowest detection limits (see below) and requires the smallest sample

volume, which is why this method is preferred for sample analysis. DGT extractions are typically diluted to an appropriate sample volume and acidity (e.g., 10 mL) prior to analysis by ICP-MS. Analysis of extracted metals by ICP-MS (or other methods) follows standard approaches (e.g., US EPA Method 6020A, APHA Method 3125) (Table 7-1).

##### 7.5.1 Instrumental Detection Limits for DGT

DGT, which are not designed to reach equilibrium with the environment, have detection limits that vary based on local conditions (e.g., temperature, sediment porosity), the metal being sampled, deployment time, and size of the section. The primary way to improve overall detection limits for DGT is to use ICP-MS for chemical analysis; ICP-MS detection limits in extractions are <0.05 µg/L for most metals of environmental concern. For DGT deployments of >6 h and vertical sections >5 mm, ICP-MS on 10× diluted extracts will be able to measure any C<sub>DGT</sub> that exceeds 1 µg/L. Detection limits below 1 µg/L can be achieved by increasing deployment time, increasing section size, decreasing the extraction volume, or using DGTs with thinner diffusion gel layers.

## Section 8

# Data Analysis: Calculation of $C_{\text{free}}$ and $C_{\text{DGT}}$

## 8.1 Introduction

In this section, for hydrophobic organic contaminants, three methods are discussed for using the passive sampler concentration data for the target contaminants determined in Section 7, with instrumental analysis, to calculate the target contaminant's  $C_{\text{free}}$ . For the hydrophobic organic contaminant passive samplers (i.e., POM, PDMS, LDPE), there are four basic approaches for handling the data analysis (Figure 8-1). The first approach assumes that the target contaminants achieved equilibrium with the passive sampler and other environmental phases during the deployment. This assumption can be based on previous experience with the passive sampler, the deployment site, or the design of the passive sampler investigation. In this approach, relatively simple equations can be applied to calculate  $C_{\text{free}}$  using the passive sampler concentration ( $C_{\text{PS}}$ ) data. These equations are discussed below. The next two approaches directly determine if the passive sampler and target contaminants have achieved equilibrium. In one approach, multiple thicknesses of POM, PDMS and LDPE are deployed and the concentrations of target contaminants on a mass or volume of passive sampler basis are compared. When the mass of target contaminant is the same between different thicknesses as a function of time, equilibrium has been achieved. In the third approach, multiple samplers are deployed and collected at varying times to develop a time series. Like the multiple thicknesses approach, when the concentration of target contaminant in the passive samplers no longer changes

significantly with time, equilibrium has been reached. These two approaches benefit by providing definitive evidence that equilibrium has occurred between the target contaminants and the passive samplers. However, these approaches both require additional deployments of passive samplers and chemical analyses which will increase overall costs. For *ex situ* deployments, these methods may be worthwhile (see the discussion of different thicknesses of PDMS in Section 3.1) but in *in situ* deployments, the additional field effort and analytical chemistry may be prohibitively expensive.

In another approach, and the one recommended in this document, equilibrium is not assumed to have occurred among the target contaminants, the passive sampler, and other environmental phases. In this case, losses of the performance reference compounds (PRCs) discussed in Section 6 are used to adjust the passive sampler concentration data from non-equilibrium concentrations to equilibrium  $C_{\text{free}}$  values. The use of PRCs to calculate  $C_{\text{free}}$ , while scientifically sound, is still an evolving practice with the potential to become complicated because of the multiple variables included in the calculations. In order to build in a degree of consistency into the application of PRCs, the use of three standardized PRC correction calculators (PCCs) accessed via graphic user interfaces (GUIs) for (1) PDMS passive sampling in a SPME fiber configuration, (2) LDPE passive sampling in sediments, and (3) LDPE passive sampling in the water column

is encouraged to ensure that all of the PRC calculations are performed uniformly. Figure 8-2 provides a flow chart for selecting the appropriate GUI to use for calculating  $C_{\text{free}}$  based on the type of polymer deployed and the kind of deployment (i.e., water column versus sediments) for LDPE and POM. The LDPE GUI can be applied with POM recognizing that the input values have to be changed to reflect the POM-specific variables like POM and water diffusion coefficients and POM partition coefficients.

The PDMS GUI and an Excel spreadsheet version of the PDMS GUI can be downloaded from this web address:

<http://www.depts.ttu.edu/cweb/groups/reiblesgroup/downloads.html>

The sediment deployment LDPE GUI can be downloaded from the following web addresses:

<https://www.serdp-estcp.org/Tools-and-Training/Tools/PRC-Correction-Calculator>

and

<https://www.epa.gov/superfund/superfund-contaminated-sediments-guidance-documents-fact-sheets-and-policies>

Additional guidance on the sediment deployment LDPE GUI is located here:

<https://www.serdp-estcp.org/Program-Areas/Environmental-Restoration/Contaminated-Sediments/ER-200915>

Finally, the water column LDPE GUI and additional guidance can be downloaded from the following address:

<https://www.epa.gov/superfund/superfund-contaminated-sediments-guidance-documents-fact-sheets-and-policies>

Figure 8-3 illustrates the data entry points and lay-out of the PDMS GUI while Figure 8-4 provides an example output from the PDMS GUI. Figures 8-5 and 8-6 report information for the sediment LDPE GUI and Figures 8-7, 8-8 and 8-9 show similar information for the water column LDPE GUI. Note that some of the partition coefficients used by the sediment LDPE GUI differ from those provided in Appendix A of this document but that the PCC GUI allows the user to select which coefficients to use.

The PCCs discussed here are highlighted because GUIs have been developed to simplify their use. Booij and Smedes (2010) describe an alternative PCC that document users are encouraged to investigate. This PCC is spreadsheet-based and can be accessed by contacting the authors of Booij and Smedes (2010).

The approach for performing the DGT data analysis results in the calculation of  $C_{\text{DGT}}$  (Figure 8-1). This data analysis is unique for metals and is discussed below.

## 8.2 POM, PDMS, and LDPE Data Analysis

Figures 8-1 and 8-2 provide flowcharts for determining how to proceed with the data analysis of passive sampler concentration data. The starting point for the data analysis is to have the concentration of target contaminants in the various passive sampler media (e.g., POM, PDMS, LDPE, DGT gel). For example,  $x \mu\text{g CB52/g POM}$ .

### 8.2.1 Equilibrium Conditions

Under demonstrated or assumed equilibrium conditions, Equation 8-1 can be applied to calculate  $C_{free}$  for hydrophobic organic target contaminants using measured passive sampler concentrations  $C_{PS}$  (more specifically,  $C_{POM}$ ,  $C_{PDMS}$ ,  $C_{LDPE}$ ) and the appropriate partition coefficient ( $K_{PS}$ ) (more specifically,  $K_{POM}$ ,  $K_{PDMS}$ ,  $K_{LDPE}$ ):

$$C_{free} = \frac{C_{PS}}{K_{PS}} \quad [8-1]$$

### 8.2.2 Non-Equilibrium Conditions using PRCs

Because passive sampler deployments are commonly too short for target contaminants to achieve equilibration with their surroundings, particularly for larger, high  $K_{ow}$  target contaminants, PRCs were developed as a tool to estimate the degree of disequilibria between the target contaminants associated with the passive sampler and the rest of the environmental phases. The GUI discussed above calculate a simple variable, the fractional equilibria ( $f_{eq}$ ) (expressed as a decimal), which can be used to adjust the measured non-equilibrium passive sampler concentration ( $C_{PS}$ ), from Section 7, to equilibrium conditions:

$$C_{free} = \frac{\left[ \frac{C_{PS}}{f_{eq}} \right]}{K_{PS}} \quad [8-2]$$

However, before  $f_{eq}$  can be calculated with a GUI, it is necessary to estimate the actual  $f_{eq}$  based on the measured PRC concentrations in the deployed passive samplers and the non-deployed passive samplers:

$$f_{eq}^m PRC^x = \frac{(C_{PRC_i}^x - C_{PRC_f}^x)}{C_{PRC_i}^x} \quad [8-3]$$

where,  $f_{eq}^m PRC^x$  is the measured fractional equilibrium for PRC x (in contrast to the calculated  $f_{eq}$  generated by the GUIs for the target contaminants),  $C_{PRC_f}^x$  is the passive sampler concentration of PRC x ( $\mu\text{g/g}$  polymer) following deployment, and  $C_{PRC_i}^x$  is the passive sampler concentration of PRC x that was loaded with PRCs but not deployed (i.e., stored in the dark at  $-4^\circ\text{C}$  until chemical analysis with the deployed passive samplers). The  $f_{eq}^m PRC^x$  values, in decimal format, will be loaded into the PCCs via the GUIs.

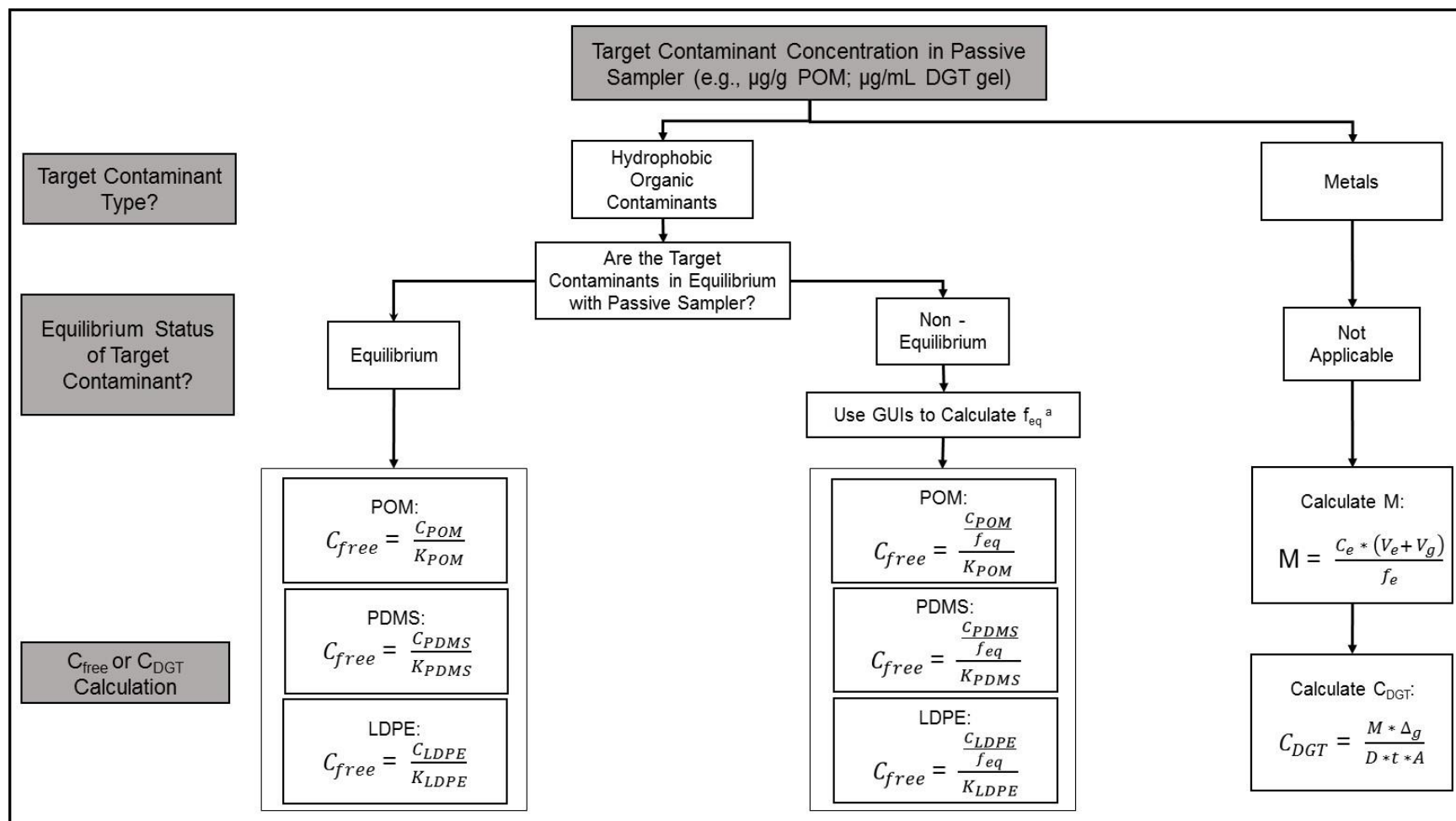
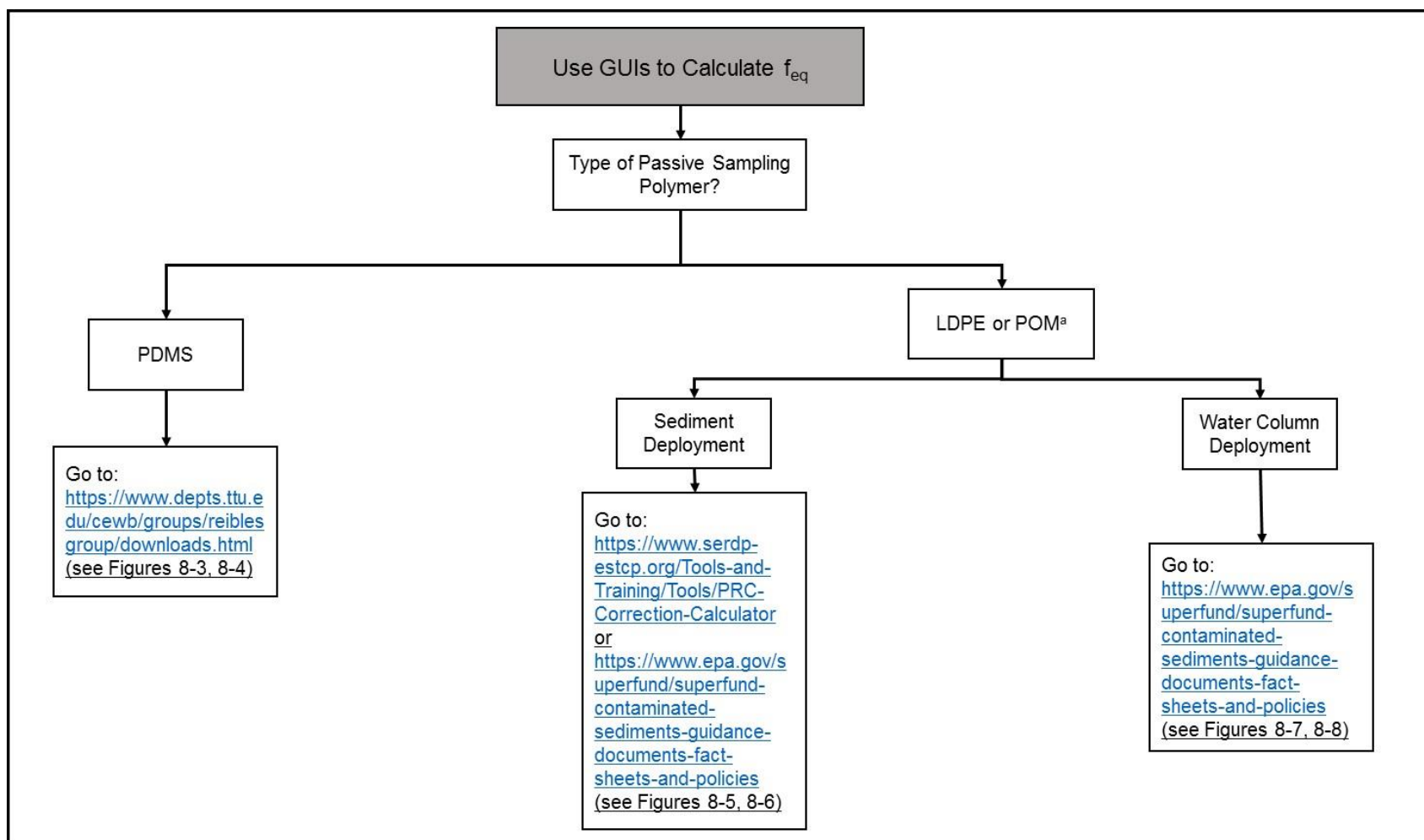

Figure 8-1. Flow chart of the approaches for analyzing passive sampler data to calculate  $C_{free}$  or  $C_{DGT}$ . <sup>a</sup> see Figure 8-2 for a flow chart for selecting the appropriate GUI.



**Figure 8-2. Flow chart for selecting the appropriate PRC Correction Calculator GUI for analyzing non-equilibrium hydrophobic organic contaminant passive sampling data to calculate  $C_{free}$ .<sup>a</sup> to use the GUIs cited in this figure with POM, the user will need to change the GUI's input values for the POM polymer.**



### 8.2.3 Example Calculations: Equilibrium versus Non-Equilibrium Conditions

Table 8-1 provides an example calculation of  $C_{\text{free}}$  for 11 PCB congeners and total PCBs from a sediment deployment, with the equilibrium assumption and non-equilibrium approaches using LDPE as the passive sampler and the sediment LDPE GUI. The equilibrium approach applied Equation 8-1 using  $\log K_{\text{LDPE}}$  taken from Appendix A. Values for CB77, CB126, and CB169 were not available in Appendix A and were calculated using Equation 4-1. The non-equilibrium approach used the sediment LDPE GUI to calculate  $f_{\text{eq}}$  values for all 11 PCB congeners based on the measured  $f_{\text{eq}}$  using the  $^{13}\text{C}$ -labelled PRCs (i.e.,  $^{13}\text{C}$ -CB28,  $^{13}\text{C}$ -CB101,  $^{13}\text{C}$ -CB180). When using the sediment LDPE GUI, the PRCs are selected from a dropdown menu, and the measured  $f_{\text{eq}}$  values are entered, as are the target contaminants. The GUI then requests the deployment duration and polymer thickness—in this case, 28 days and 25  $\mu\text{m}$ , respectively, and the type of PRC (i.e.,  $^{13}\text{C}$ ). The sediment LDPE GUI uses a default setting of 0.7 for the sediment porosity, unless the user enters another value. Once this information is entered, the GUI calculates and displays the  $f_{\text{eq}}$  for the target contaminants (Table 8-1). The user can then take the calculated  $f_{\text{eq}}$  and, using Equation 8-2, calculate the non-equilibrium-adjusted  $C_{\text{free}}$  for each target contaminant.

It is worth noting that, unless the samplers have been deployed for a very long time, the use of the non-equilibrium approach will almost always result in larger congener and total PCB  $C_{\text{free}}$  values than if one assumes equilibrium. For example, for the data in Table 8-1, the non-equilibrium congener  $C_{\text{free}}$  values were 13% to 80% greater in magnitude than the equilibrium approach  $C_{\text{free}}$  values. In addition, total PCB  $C_{\text{free}}$  was 19% larger for the non-equilibrium approach than for the equilibrium approach. Critically, the greatest divergence between approaches is for the higher molecular weight target contaminants (e.g., CB138, CB169, CB180), and these will frequently be the most readily bioaccumulated (although also typically having much lower  $C_{\text{free}}$  values) and sometimes the most toxic forms of a given target hydrophobic organic contaminant.

(1) Enter the PDMS thickness and deployment duration

(2) List of possible PRCs to select from

(3) After selecting PRCs, enter measured PRC ratio (i.e., measured  $f_{eq}^m$ ) values (in decimal format (e.g., 0.25)) and the type of PRC used in the deployment

In this box, the calculated  $f_{eq}$  values and a plot of the results will be presented

In this box, additional PMDS GUI options and background information are available

(4) Select target contaminants

(5) For the regression used to calculate the  $f_{eq}$  values, the intercept can be set to 1

(6) Press to calculate  $f_{eq}$  values

**Compound Properties**

Compound	logKow	logKf
Naphthalene	3.4100	2.9513
Acenaphthyl...	3.7100	3.1688
Acenaphthene	4.0600	3.4225
Fluorene	4.2000	3.5240
Phenanthrene	4.7400	3.9155
Anthracene	4.6900	3.8793

Figure 8-3. Primary data entry points and basic layout of the graphical user interface (GUI) for the PDMS PRC Correction Calculator

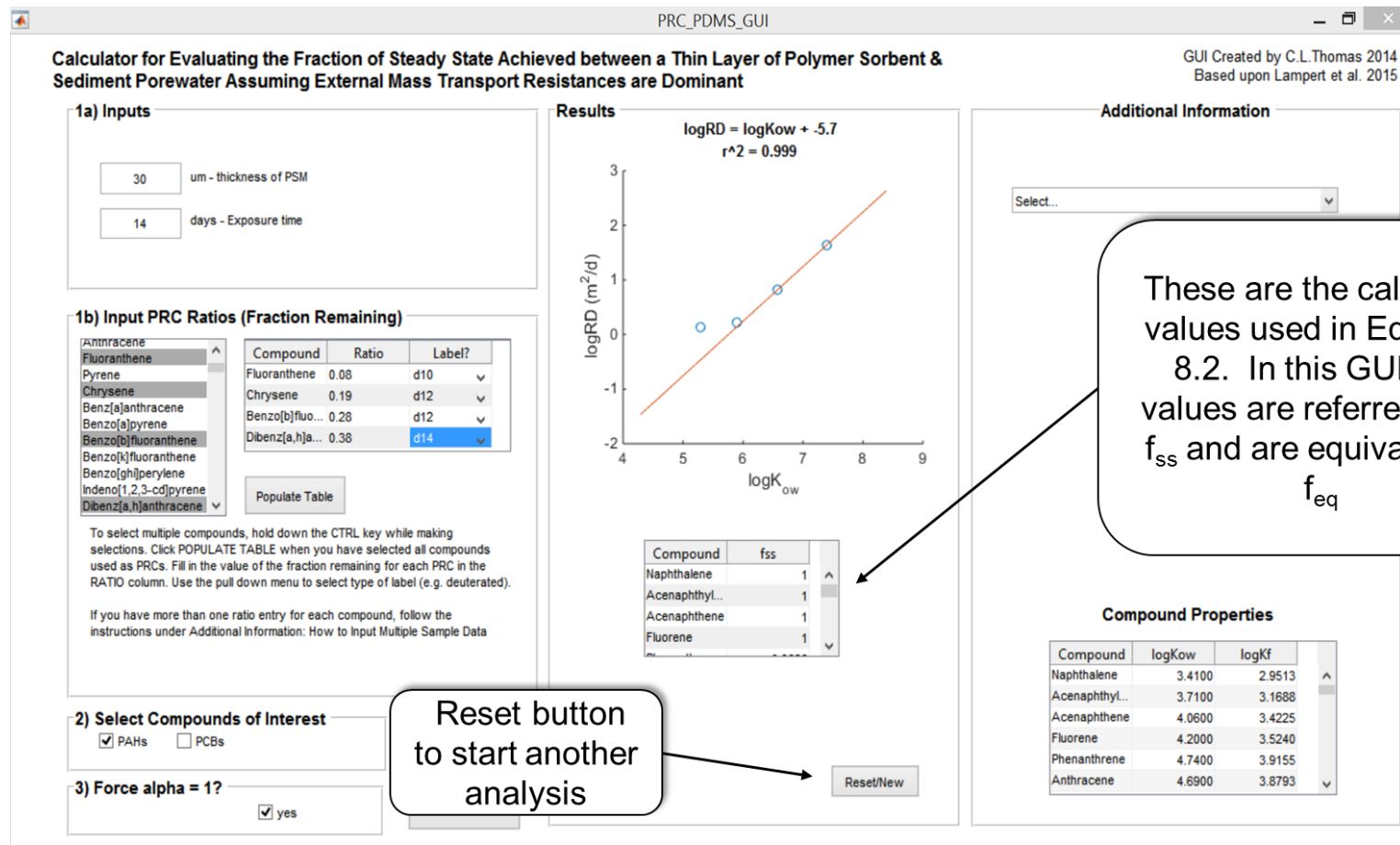
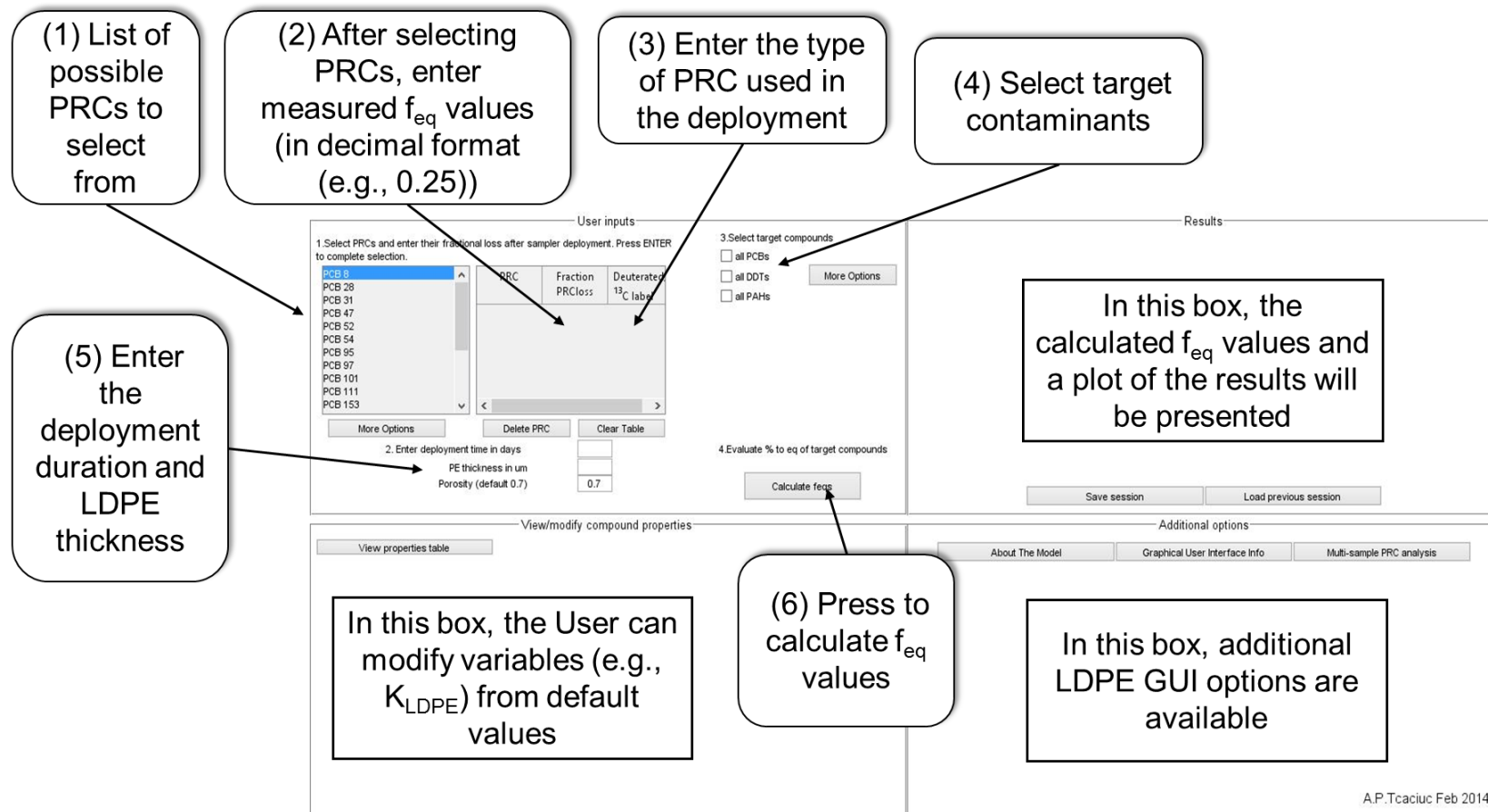

Figure 8-4. Example output from the GUI for the PDMS PRC Correction Calculator



**Figure 8-5. Primary data entry points and basic layout of the GUI for the sediment deployment LDPE PRC Correction Calculator**

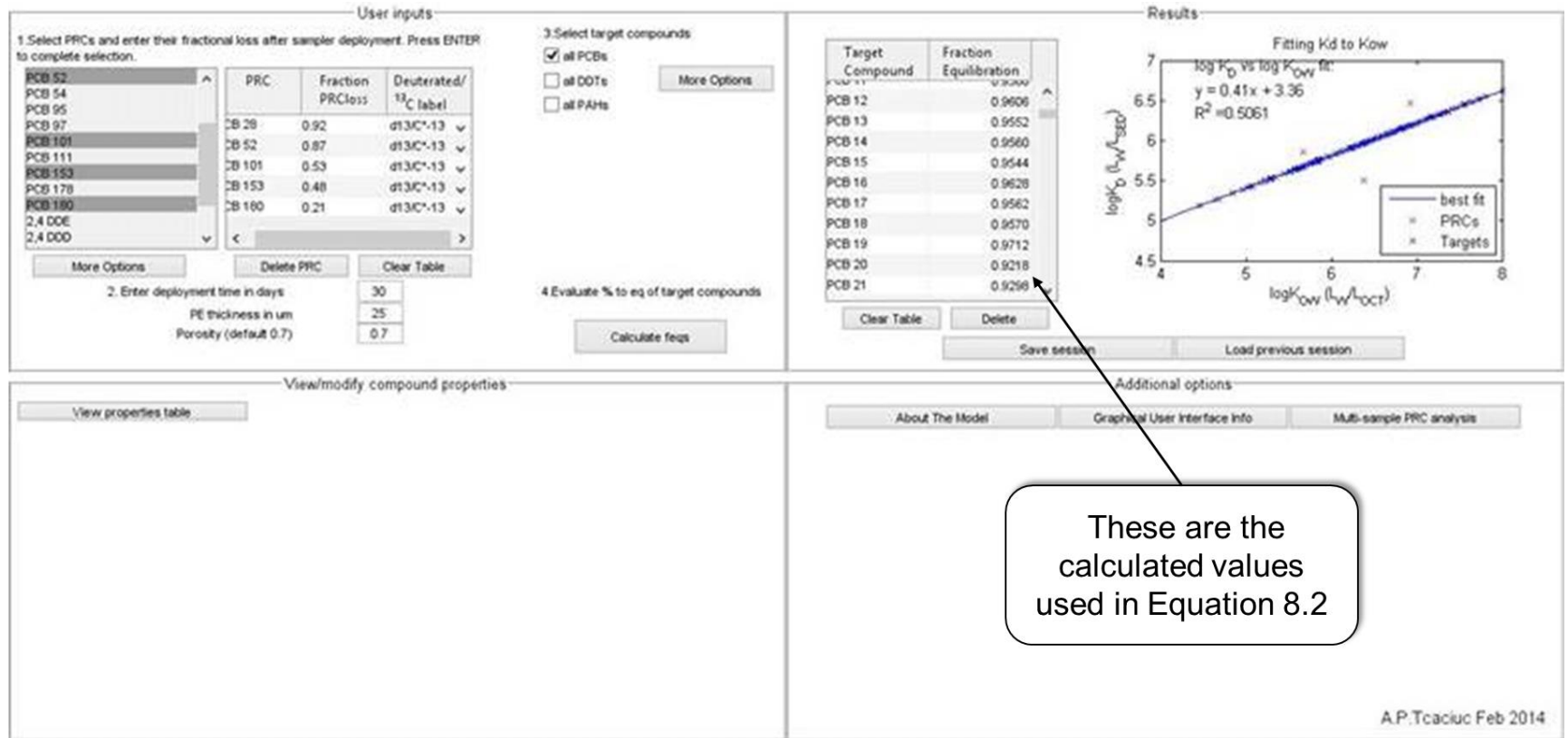
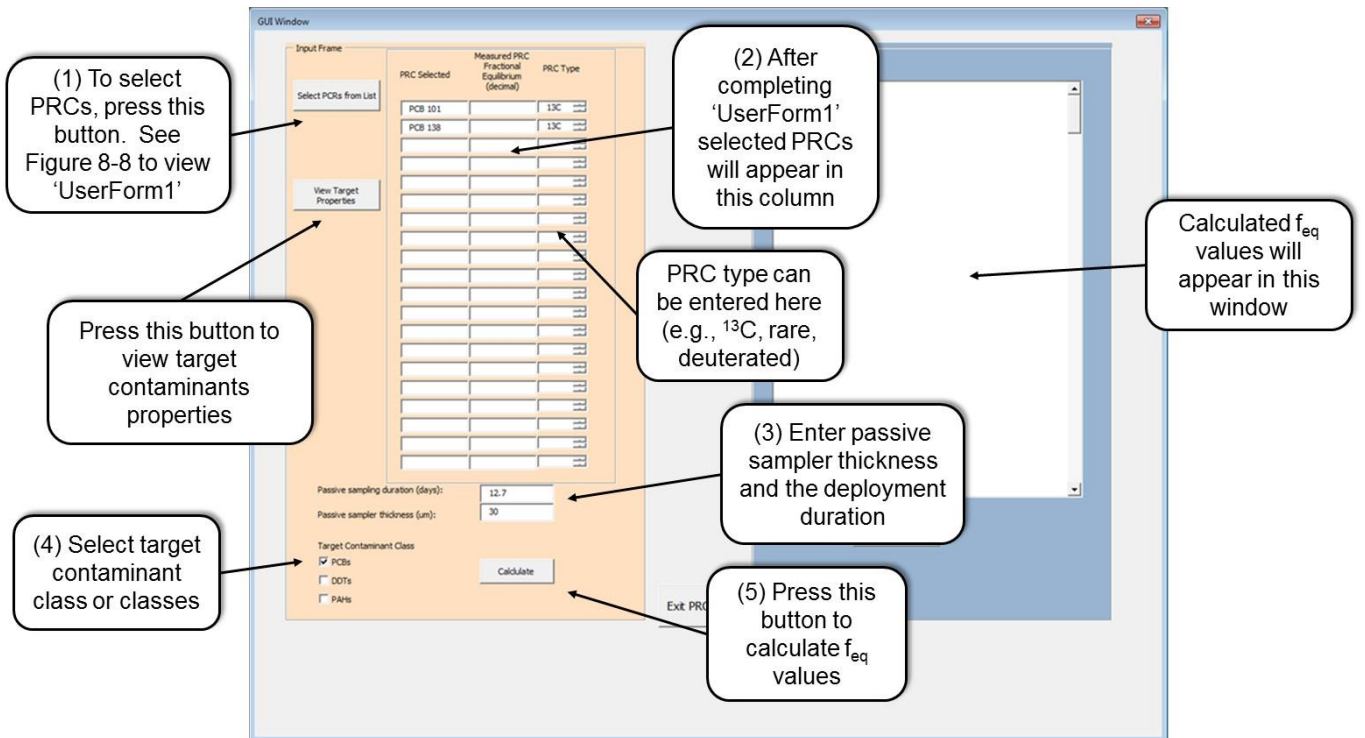
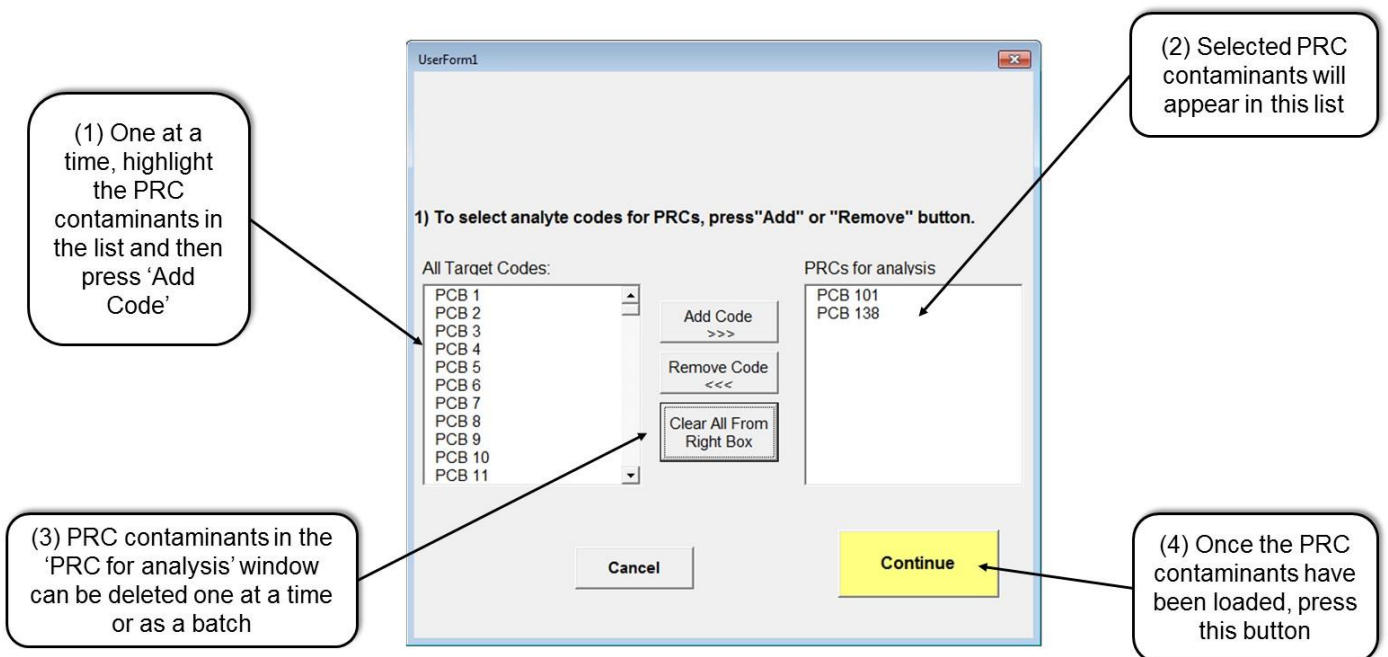

Figure 8-6. Example output from the GUI for the sediment deployment LDPE PRC Correction Calculator



**Figure 8-7. Primary data entry points and basic layout of the GUI for the water column deployment LDPE PRC Correction Calculator**



**Figure 8-8. Example of data entry window ('UserForm1') for the water column LDPE PRC Correction Calculator**

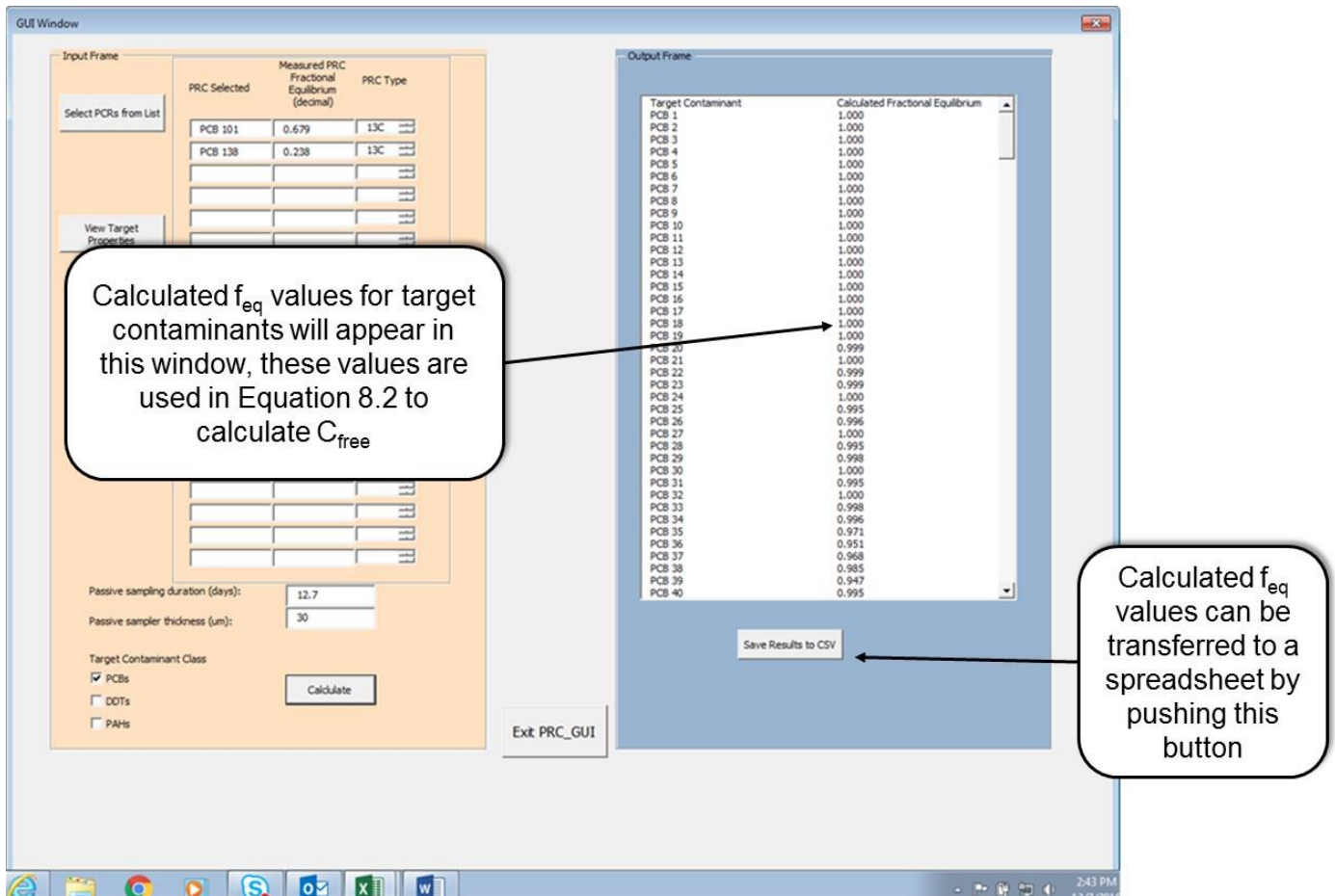

**Figure 8-9. Example output from the GUI for the water column deployment LDPE PRC Correction Calculator**

**Table 8-1. Example calculations of  $C_{free}$  for 11 PCB congeners and total PCBs using a LDPE passive sampler and the sediment LDPE GUI PRC Correction Calculator based on the equilibrium and non-equilibrium approaches discussed above.**

PRC or Target Contaminant <sup>a</sup>	Measured $C_{LDPE}$ ( $\mu\text{g/L}$ LDPE)	Log $K_{LDPE}$ <sup>b</sup>	Measured $f_{eq}$ based on PRCs	Calculated $f_{eq}$ based on LDPE PCC	Equilibrium assumed $C_{free}$ (pg/L) [Equation 8-1]	Non-Equilibrium PRC-based $C_{free}$ (pg/L) [Equation 8-2]
<sup>13</sup> C-CB28	-	-	0.90	-	-	-
<sup>13</sup> C-CB101	-	-	0.50	-	-	-
<sup>13</sup> C-CB180	-	-	0.25	-	-	-
CB28	120	5.4	-	0.87	4940	5670
CB52	67	5.55	-	0.83	1900	2290
CB66	53	5.95	-	0.72	597	829
CB77	12	6.24*	-	0.65	6.91	10.6
CB99	52	6.38	-	0.63	221	350
CB101	39	6.18	-	0.63	258	410
CB110	42	6.16	-	0.59	296	502
CB126	9	6.87*	-	0.40	1.21	3.04
CB138	35	6.82	-	0.42	53.4	127
CB169	5	7.50*	-	0.20	0.16	0.79
CB180	26	7.24	-	0.22	15.4	70.1
Total PCBs	-	-	-	-	8290	10300

<sup>a</sup> <sup>13</sup>C-labeled PCBs were the PRCs.

<sup>b</sup> From Appendix A unless \* is present indicating this value was calculated using Equation 4-2.



### 8.3 DGT Data Analyses

Following the extraction and analyses for metals discussed in Section 7, the metal concentrations in the DGT gel extract are used to calculate a mass associated with the resin gel ( $M$  in  $\mu\text{g}$ ) (Figure 5-1):

$$M = \frac{C_e * (V_e + V_g)}{f_e} \quad [8-4]$$

where,  $C_e$  is the metal concentration in the acid extract ( $\mu\text{g/mL}$ ),  $V_e$  is the volume of the acid extract plus any volume used for dilution (mL),  $V_g$  is the volume of the gel (mL), and  $f_e$  is the elution factor. For standard DGT disks (i.e., resin gel thickness of 0.4 mm),  $V_g$  is 0.196 mL. For the DGT probes,  $V_g$  can be calculated using the formula for the volume of a rectangular prism (i.e.,  $V_g = \text{length} * \text{width} * \text{height}$ ) ( $h = 0.04$  cm,  $w = 1.8$  cm); for example, a 1-cm vertical section length of gel has a volume of 0.072 mL. The elution factor may be necessary if 1M  $\text{HNO}_3$  does not completely extract all of the metal from the resin gel. For Zn, Cd, Cu, Ni, Pb, and Mn, a  $f_e$  value of 0.8 can be used, and for Fe, a  $f_e$  value of 0.7 can be used. Alternatively, matrix spikes can be performed to determine elution recoveries. With the mass on the resin gel calculated, the concentration of metal at the surface of the DGT device ( $C_{\text{DGT}}$  in  $\mu\text{g/mL}$ ) can be calculated as:

$$C_{\text{DGT}} = \frac{M * \Delta_g}{D * t_d * A} \quad [8-5]$$

where,  $\Delta_g$  is thickness of the diffusive gel and membrane filter (cm),  $D$  is the diffusion coefficient in the gel ( $\text{cm}^2/\text{s}$ ),  $t_d$  is the time of deployment (s), and  $A$  is the surface area of the DGT exposed to the sediment ( $\text{cm}^2$ ). For both disk and probe assemblies, standard DGTs have  $\Delta_g$  of 0.93 mm. Metal diffusion in the DGT gel increases with increasing temperature following a polynomial function.  $D$  in the

DGT diffusive gel has been calculated for 11 metals for temperatures from 1 to 35°C (Appendix D). For DGT disks,  $A$  is 3.14  $\text{cm}^2$ , and for DGT probes,  $A$  is determined by the size of the sectioned resin gel (e.g., 1.8  $\text{cm}^2$  for a 1-cm vertical section).

#### 8.3.1 Example DGT Calculations

As an example calculation, if a 1-cm section of a standard DGT probe ( $V_g = 0.072$  mL) was dissolved in 1 mL of nitric acid ( $\text{HNO}_3$ ),  $V_e = 1.0$  mL, and a Ni concentration in the extract of 869  $\mu\text{g/L}$  was analytically measured, using Equation 8-4, the nickel mass bound to the gel ( $M$ ) would be calculated as 1.16  $\mu\text{g}$ . Next, using Equation 8-5, if the DGT had been deployed for 23 h at 18.3°C, a  $C_{\text{DGT}}$  of 152  $\mu\text{g/L}$  would be calculated.

### 8.4 Case Studies

To illustrate the application of passive sampling, the following case studies are included in Appendix F of the document:

- **Case Study 1:** Lower Grasse River, New York, USA
- **Case Study 2:** Pacific Sound Resources Superfund Site (Marine Sediment Unit), Seattle, Washington, USA
- **Case Study 3:** Wyckoff/Eagle Harbor Superfund Site (East Harbor Operable Unit), Bainbridge Island, Washington, USA
- **Case Study 4:** United Heckathorn Superfund Site (Lauritzen Channel, Inner Richmond Harbor), California, USA
- **Case Study 5:** Site Assessment of Sediment Toxicity, San Diego Bay, California, USA
- **Case Study 6:** *Ex situ* Passive Sampling Measurement of Site-Specific Partitioning of PAHs and PCBs in Sediments

These case studies provide a comprehensive demonstration of the preparation, deployment, recovery, and data analysis of various types of passive samplers discussed in this document.

## Section 9

# Quality Assurance and Quality Control, and Other Considerations

## 9.1 Introduction

This section is intended to provide general guidance for addressing data quality and assurance considerations relative to passive sampling. The section is not exhaustive and is intended to allow research and commercial laboratories flexibility when preparing their

standard operating procedures for their specific facilities. Table 9-1 provides a summary of the quality assurance and quality control samples prepared for hydrophobic organic contaminant polymer passive samplers.

**Table 9-1. Summary of quality assurance and quality control samples prepared for hydrophobic organic contaminant polymer passive samplers.**

Quality Assurance/ Control Measure	Purpose	Comment
Deployment blank	Detect contamination of the sampler during deployment process	Also called a 'Field blank' and 'Trip blank'
Retrieval blank	Detect contamination of the sampler during retrieval process	Also called a 'Field blank' and 'Trip blank'; Not necessary if passive samplers are processed by addition to organic solvent immediately after on-site retrieval
Field solvent blank	Indicate contamination of solvent used during retrieval process	-
Field control samples	Indicate loss of solvent during transport related to the retrieval process	-
Field internal standards	Indicate loss of solvent during transport in each field sample related to the retrieval process	Standard added to each field sample (should not be a chemical found in the field or being used as a PRC)
Surrogate standards	Indicate performance of extraction	Also called an 'Internal standards'
PRC-loaded passive sampler reproducibility standards	Indicate reproducibility of PRC loading into passive samplers	

## 9.2 Hydrophobic Organic Contaminant Polymer-Specific Quality Assurance and Quality Control

### 9.2.1 *Polymer-Specific Deployment Blanks (i.e., trip blanks, field blanks)*

The polymers used for passive sampling have high partition coefficients for hydrophobic organics, so there is a significant chance of contaminating the polymers via exposure to the laboratory or field environment. Passive samplers used for measurement should be protected from the laboratory and field environment through adequate containment and storage in clean glass jars (i.e., solvent washed and muffled). Such contamination problems are especially important when measurements are being performed at low concentrations and background reference sites, and the types of target contaminants being measured are ubiquitous in the environment, such as low molecular weight PAHs. Thus, every passive sampling investigation should include an adequate set of laboratory and field blanks. The laboratory performing the passive sampling measurements should demonstrate the absence of contamination of field and laboratory blanks at the practical quantitation limits. In addition, the laboratory should demonstrate that no significant loss of loaded PRCs occurred before sampler deployment in the field. Maintaining loaded samplers at 4°C or less prior to deployment will limit PRC losses.

A deployment blank should be employed during the deployment. The deployment blank is a sampler that is shipped together with other samplers (i.e., deployed) to the field but is shipped back without being deployed. A retrieval blank is a sampler that is shipped together with the other samplers on retrieval, but is not needed if the samplers are processed immediately on retrieval. Both the recovery and retrieval blanks will include PRCs if the regular passive samplers being deployed and

retrieved include PRCs. The field blanks are used to assess possible presence of environmental contamination during deployment activities. Field blanks should have no significant peaks where PRCs, surrogate standards, injection standards, and target analytes occur (<0.1 ng/g passive sampler).

### 9.2.2 *Field Solvent Blanks*

For studies in which solvent will be added to vials containing the recovered samplers, a field solvent blank should be included. Field solvent blanks will be analyzed at the time of filling the vials for shipment (i.e., one at the start of filling the vials and one at the end where the same solvent source, has been used). If these contain target contaminants at significant levels, new vials will be filled from a separate source, and the process will be repeated. In addition, solvent blanks should be shipped with the samples at a frequency of 1 per 20 samples.

### 9.2.3 *Field Control Samples*

Field control samples are used to track the solvent volume change of contamination during transport if on-site processing of samplers is performed. The field control samples can be calibration standards or other solutions with known concentrations (note: if using calibration standards, these same standards should not be used for the analytical instrumental calibration). The field control samples are treated identically as other samples. At least five field control samples are needed for each deployment. They can be five different concentrations or five replicates of the same concentration if estimations of field concentrations are available. The average of the concentration change for all compounds in all field control samples should be within 15% to avoid the need to make solvent volume adjustments.

#### 9.2.4 *Field Internal Standards*

Although field control samples indicate solvent stability during transport, internal standards are recommended for field samples to indicate any changes in solvent loss in individual samples. Deuterated PAHs and  $^{13}\text{C}_{12}$ -labelled PCB congeners are good choices for internal standards. If an internal standard is used it should be included in the extraction vials. The chosen compound should not be present in the field in significant quantities and should not be used as a PRC. The average of the concentration changes for all internal standards added in each sample should be within 15% of a laboratory prepared field internal standard (assume no losses in this standard) to avoid the need to make solvent volume adjustments to account for losses while in the field.

#### 9.2.5 *Recoveries of Surrogate Standards (also known as Internal Standards)*

Surrogate standards should be recovered from passive sampling samples at 100%, plus or minus analytical precision, >70% to <120%. An exception may be relatively volatile compounds (e.g., mono-, dichlorobiphenyls) that can be lost in significant amounts when extracts are evaporated (e.g., recovery down to 60%). Typical surrogates used for PCB analysis in the GC/ECD analytical method are: PCB-14, PCB-65, and PCB-166.

#### 9.2.6 *PRC-Loaded Passive Sampler Reproducibility*

Individual batches of passive samplers loaded with PRCs should exhibit reproducible PRC concentrations (e.g., coefficient of variation <20%) in the passive sampler before deployment.

#### 9.2.7 *QC Samples for Chemical Analysis*

The QC samples for chemical analysis of PAHs and PCBs, including initial calibration, second-source standard check, and continued calibration verification checks should meet the acceptance criterion set in the analytical methods of each laboratory. These QC standards are not unique to passive sampling. A complete set of example guidelines for quality assurance and quality control (QA/QC) based on the U.S. Department of Defense Quality Management System (QMS) can be found in Appendix E. These guidelines are not intended as required but are provided as examples.

#### 9.2.8 *Specific Quality Assurance for POM*

When correct procedures are followed in the use of POM in passive sampling applications, the analytical results have high accuracy and reproducibility. Key to the success of any passive sampling approach is the accurate determination of polymer partitioning constants for the target contaminants of interest. A recent report by Arp et al. (2015) reviewed reported results from six studies for PCBs and three studies for PAHs and found that the majority of the differences could be attributed to different thicknesses of POM used (lack of equilibrium) and different extraction procedures applied. They report that when the correct thickness of POM ( $\leq 76 \mu\text{m}$ ) and a hexane-acetone mixture are used for the extraction of this polymer, the reported  $K_{\text{POM}}$  values for PCBs and PAHs are highly reproducible (e.g., within 0.2 log units). Thus, for POM, it is critical to ensure that the thickness of POM used is  $76 \mu\text{m}$  or less. Also, it is very important to use the same POM as used in the  $K_{\text{POM}}$  determination. This point is also true for PDMS and LDPE. The most widely used  $K_{\text{POM}}$  values are for the  $76 \mu\text{m}$  POM from CS Hyde Company (Table 1-1) which is made with an ethylene oxide copolymer.

Most of the published studies have reported use of POM in the determination of equilibrium aqueous concentrations in sediments based on *ex situ* laboratory experiments. At the time of this publication, there have been few studies of *in situ* application of POM with performance reference compound (PRC) corrections.

### 9.2.9 Specific Quality Assurance for PDMS

Use of PDMS can result in high analytical accuracy and reproducibility (Thomas et al. 2014). A calibration study of the PDMS fiber in prepared water with PAHs found that the linearity of the resulting calibration for mid-range HOCs was very high with  $r^2 = 0.99$  (Reible 2010). Coefficients of variation from the resulting linear curve were less than 20% for all PAH compounds except naphthalene. Naphthalene does not concentrate significantly on the PDMS fiber, and losses to air are rapid, making it difficult to measure naphthalene via PDMS without increasing the PDMS layer volume. Coefficients of variation by conventional extraction methods have also been seen to be 10% to 20%, suggesting that the levels of accuracy of the PDMS methods were essentially identical to that expected by conventional methods. Like POM, to ensure acceptable data quality assurance, it is very important, whenever possible, to use the same batch and thickness of PDMS for developing  $K_{PDMS}$  values as for performing actual deployments.

### 9.2.10 Specific Quality Assurance for LDPE

The first concern when using all of the polymers, including LDPE, is to quantify organic contaminants, especially in interstitial waters, as *accurately* as possible. Several investigations have been pursued to test this measurement for LDPE. First, Fernandez et al. (2009a, b) used *ex situ* testing with sediments from three sites (two in Boston Harbor and one in San Francisco Bay) to demonstrate that PRC-corrected measures of PAHs in interstitial

water were very close to direct measures of the PAHs in isolated interstitial waters, after making corrections for the presence of colloid-bound PAHs in the water samples. Further, Gschwend et al. (2011) used *ex situ* testing of PCB-contaminated sediments from Hunters Point in San Francisco Bay to test the accuracy of the LDPE approach. As an independent reference, air bridge sampling was used to avoid problems with other partitioning phases (e.g., colloids); a set of six replicates revealed that congener 101 (2, 2', 4, 5, 5'-pentachlorobiphenyl) was present at a little less than 1 ng/L in the interstitial water. Isolation of the interstitial water and its analysis suggested a concentration near 5 ng/L, until corrections for colloid-associations were used and lowered the estimated interstitial water concentration to about 2 ng/L. Using the commonly applied equilibrium partitioning modelling suggested a interstitial water concentration of 32 ng/L; this result was clearly divergent from the air bridges. Correcting this approach by using a sorption coefficient that included adsorption to black carbon measured in this sediment (see Lohmann et al. 2005) lowered the estimated interstitial water concentration to less than 0.5 ng/L. Finally, analyses of multiple LDPE samplers left in the sediment for a week, and another set for a month, resulted in PRC-corrected interstitial water concentrations of about 1 and about 0.5 ng/L, respectively. Clearly, the use of the LDPE samplers was much more accurate than equilibrium partitioning modelling, and the LDPE results matched the air bridges to within a factor of 2. Like POM and PDMS, to ensure acceptable data quality assurance, it is very important, whenever possible, to use the same batch and thickness of LDPE for developing  $K_{LDPE}$  values as for performing actual deployments.

### 9.2.11 *Passive Sampling Example Sampling and Analysis Project Plan (SAP) and Quality Assurance Project Plan (QAPP)*

Appendix G contains two documents that are intended to assist the reader in the preparation of future QAPPs involving passive sampling. The first document is the Sampling and Analysis Plan for River Mile 11 East (RM11E) Study Area. The RM11E study was conducted to supplement the Portland Harbor Superfund Site (Portland Harbor) Draft Investigation. The goal of the investigation was to collect interstitial water data for input into a sediment cap isolation model and to inform cap design.

Appendix G also includes a copy of the QAPP prepared for the 2011 deployment of LDPE samplers at the Palos Verdes Shelf Superfund site off the coast of Los Angeles (California, USA). Goals of the deployment were to investigate the release of target contaminants from the contaminated sediment into the water column.

## 9.3 DGT-Specific Quality Assurance and Quality Control

### 9.3.1 *DGT Quality Control*

There is a risk of contamination during preparation, transport, storage, and handling of the DGTs, so a field blank should be used to best account for this possible contamination (Knutsson et al. 2014). DGT field blanks should be extracted and analyzed using the same procedures completed for those deployed (Villanueva et al. 2013). For all deployments, at least (triplicate blanks are preferred) one extra DGT should be deoxygenated, marked, and processed in the same manner as all other DGTs with the exception of being exposed to sediment. This “control” DGT is used to verify that the solution used to deoxygenate the probes and any associated handling does not introduce any metal contamination to the

DGTs. Blank values should then be subtracted from the values obtained from the field deployed DGTs (Villanueva et al. 2013). Additionally, all equipment (e.g., storage vessel, forceps, centrifuge tubes, gel sectioning plate) should be acid-cleaned with >1M acid to ensure that no metals are introduced during use and processing.

### 9.3.2 *DGT Quality Assurance*

A potential concern with DGTs is uncertainty in the measurements including error in the thickness of the diffusive gel and the cross sectional diffusive area (Warnken et al. 2006). A recent paper suggested the measured values for diffusive gel thickness were 1.1%-2.2% smaller than their nominal value and sampling area was generally underestimated by 1.4  $\mu\text{m}$  (Kruzeder et al. 2015). When grouping the total uncertainties from DGT sampling under well-controlled experimental conditions, including sample preparation and analytical work, uncertainties of 0.3-3.3% for low target contaminant concentration case studies and 3-6% for higher target contaminant concentrations were identified (Kruzeder et al. 2015).

Understanding the diffusive boundary layer (DBL) that forms on the exposed side of the device can be important to the performance of effective DGT techniques (Turner et al. 2014). The DBL has been identified as a possible factor in ensuring accurate time-weighted average concentrations. For well-controlled laboratory experiments and/or *in situ* field deployments where absolute accuracy is not a concern, the DBL can generally be negated (Warnken et al. 2006). However, when accuracy and precision are important, the DBL should be estimated as effectively as possible and included in expanded DGT equations (see Turner et al. 2014, Warnken et al. 2006, Kruzeder et al. 2015). Accounting for the DBL is particularly important for longer term deployments and in systems with fluctuating

flows, high suspended particular matter, and/or biofouling, where the exclusion of the DBL in calculations can lead to significantly underestimated concentrations (Turner et al. 2014). Although actually measuring the DBL for DGTs is not readily possible, the thickness can be estimated in some circumstances. For example, if DGTs are deployed in systems with a high flowrate and elevated turbulence, the DBL will be close to zero. Also, if the DGT is oriented so that the surface of the filter membrane is perpendicular to the flow, the DBL will be negligible. For non-flowing systems, placing the DGT near the water surface where wind and wave action will mix the water, the DBL will approach smaller, less important values. Continuing to identify these key uncertainties and optimizing these areas should help reduce the uncertainties of DGT techniques (Knutsson et al. 2014).

## Section 10

# References

- Accardi-Dey A, PM Gschwend. 2002. Assessing the combined roles of natural organic matter and black carbon as sorbents in sediments. *Environ Sci Technol* 36: 21-29.
- Adams RG, Lohmann R, Fernandez LA, MacFarlane JK, Gschwend PM. 2007. Polyethylene devices: Passive samplers for measuring dissolved hydrophobic organic compounds in aquatic environments. *Environ Sci Technol* 41(4):1317–1323.
- Adams WJ, Kimerle RA, Mosher RG. 1985. Aquatic safety assessment of chemicals sorbed to sediments. In: Cardwell RD, Purdy R, Bahner RC, editors. Aquatic toxicology and hazard assessment: Seventh symposium. Philadelphia (PA): ASTM. ASTM STP 854. p 429–453.
- Ahn S, Werner D, Karapanagioti HK, McGlothlin DR, Zare RN, Luthy RG. 2005. Phenanthrene and pyrene sorption and intraparticle diffusion in polyoxymethylene, coke, and activated carbon. *Environ Sci Technol* 39:6516–6526.
- Allen HE, Fu G, Boothman W, DiToro DM, Mahony JD. 1991. Determination of acid volatile sulfide and selected simultaneously extractable metals in sediment. EPA/821/12-91/100. U.S. Environmental Protection Agency, Washington, DC.
- Ankley G, Di Toro D, Hansen D, Berry W. 1996. Assessing the ecological risk of metals in sediments. *Environ Toxicol Chem* 15:2053–2055.
- Apell JN, PM Gschwend. 2014. Validating the use of performance reference compounds in passive samplers to assess porewater concentrations in sediment beds. *Environ Sci Technol* 48:10301-10307.
- Apell JN, Tcaciuc AP and Gschwend, P.M. 2015. Understanding the rates of nonpolar organic chemical accumulation into passive samplers deployed in the environment: Guidance for passive sampler deployments. *Integr Environ Assess Manage* 12:486-492.
- Arp HP, Breedveld GD, Cornelissen G. 2009. Estimating the *in situ* sediment-porewater distribution of PAHs and chlorinated aromatic hydrocarbons in anthropogenic impacted sediments. *Environ Sci Technol* 43(15): 5576–5585.
- Arp HP, Hale SE, Krusa ME, Cornelissen G, Grabanski CB, Miller DJ, Hawthorne SB. 2015. Review of polyoxymethylene passive sampling methods for quantifying freely dissolved porewater concentrations of hydrophobic organic contaminants. *Environ Toxicol Chem* 34: 710–720.
- Arthur CL, Pawliszyn J. 1990. Solid phase microextraction with thermal desorption using fused silica optical fibers. *Anal Chem* 62(19):2145–2148.
- Babut MP, Ahlf W, Batley GE, Camusso M, Deckere ED, Besten PJD. 2005. International overview of sediment quality guidelines and their uses. In: Wenning RJ, Batley GE, Ingersoll CG, Moore DW. (Eds.) *Use of Sediment Quality Guidelines and Related Tools for the Assessment of Contaminated Sediments*. Society of Environmental Toxicology and Chemistry Press, Pensacola, FL. pp. 345–381.



- Baker RA. 1980a. *Contaminants and Sediments Vol 1—Fate and Transport, Case Studies, Modeling, Toxicity*. Ann Arbor Science, Ann Arbor, MI.
- Baker RA. 1980b. *Contaminants and Sediments Vol 2—Analysis, Chemistry, Biology*. Ann Arbor Science, Ann Arbor, MI.
- Bao LJ, You J, Zeng EY. 2011. Sorption of PBDE in low-density polyethylene film: implications for bioavailability of BDE-209. *Environ Toxicol Chem* 30(8):1731–1738.
- Barthe M, Pelletier E, Breedveld GD, Cornelissen G. 2008. Passive samplers versus surfactant extraction for the evaluation of PAH availability in sediments with variable levels of contamination. *Chemosphere* 71(8):1486–1493.
- Baudo R, Giesy J, Muntau H. 1990. *Sediments: Chemistry and Toxicity of In-Place Pollutants*. Lewis, Boca Raton, FL.
- Bayen SP, ter Laak TL, Buffle J, Hermens JLM. 2009. Dynamic exposure of organisms and passive samplers to hydrophobic chemicals. *Environ Sci Technol* 43(7):2206–2215.
- Beckingham B, Ghosh U. 2011. Field-scale reduction of CB bioavailability with activated carbon amendment to river sediments. *Environ Sci Technol* 45(24):10567–10574.
- Beckingham B, Ghosh U. 2013. Polyoxymethylene passive samplers to monitor changes in bioavailability and flux of PCBs after activated carbon amendment to sediment in the field. *Chemosphere* 91:1401–1407.
- Beckingham B, Buys D, Vandewalker H, Ghosh U. 2013. Observations of limited secondary effects to benthic invertebrates and macrophytes with activated carbon amendment in river sediments. *Environ Toxicol Chem* 32(7):1504–1515.
- Belzile N, De Vitre R, Tessier A. 1989. *In situ* collection of diagenetic iron and manganese oxyhydroxides from natural sediments. *Nature* 340:376–377.
- Booij K, Sleiderink HM, Smedes F. 1998. Calibrating the uptake kinetics of semipermeable membrane devices using exposure standards. *Environ Toxicol Chem* 17(7):1236–1245.
- Booij K, Smedes F, van Weerlee EM. 2002. Spiking of performance reference compounds in low density polyethylene and silicone passive water samplers. *Chemosphere* 46(8):1157–1161.
- Booij K, Smedes F. 2010. An improved method for estimating *in situ* sampling rates of nonpolar passive samplers. *Environ Sci Technol* 44:6789–6794.
- Brumbaugh WG, May T, Besser JM, Allert A, Schmitt C. 2007. Assessment of elemental concentrations in streams of the New Lead Belt in southeastern Missouri 2002–05. Scientific investigations report 2007–5057. U.S. Geological Survey. 57 pp.
- Burgess RM, Scott KJ. 1992. The Significance of in-place contaminated marine sediments on the water column: processes and effects. In; Burton GA (ed.) *Sediment Toxicity Assessments*. Lewis Publishers, Inc, Boca Raton, FL, pp. 129–165.
- Burgess RM, Berry DR, Mount DM, Di Toro WJ. 2013. Critical review: Mechanistic sediment quality guidelines based on contaminant bioavailability: Equilibrium partitioning sediment benchmarks (ESBs). *Environ Toxicol Chem* 32:102–114.
- Burton GA. 1992. *Sediment Toxicity Assessment*. Lewis Publishers, Inc, Boca Raton, FL.

- Burton GA. 2010. Metal bioavailability and toxicity in sediments. *Crit Rev Env Sci Tec* 40:852–907.
- Burton GA, Nguyen LTH, Janssen C, Baudo R, McWilliam RA, Bossuyt B, Beltrami M, Green A. 2005. Field validation of sediment zinc toxicity. *Environ Toxicol Chem* 24:541–553.
- Cantwell MG, Burgess RM, Kester DR. 2002. Release and phase partitioning of metals from anoxic estuarine sediments during periods of simulated resuspension. *Environ Sci Technol* 36:5328–5334.
- Carignan R, Rapin F, Tessier A. 1985. Sediment porewater sampling for metal analysis: A comparison of techniques. *Geochim Cosmochim Acta* 49:2493–2497.
- Carr, R.S. and M. Nipper (eds). 2003. *Porewater Toxicity Testing: Biological, Chemical, and Ecological Considerations*. SETAC Technical Publication. SETAC Press. Pensacola, FL.
- Chen S-J, Luo X-J, Mail B-X, Sheng G-Y, Fu J-M, Zeng EY. 2006. Distribution and mass inventories of polycyclic aromatic hydrocarbons and organochlorine pesticides in sediments of the Pearl River estuary and the northern South China Sea. *Environ Sci Technol* 40:709–714.
- Cornelissen G, Gustafsson O, Bucheli TD, Jonker MT, Koelmans AA, van Noort PC. 2005. Extensive sorption of organic compounds to black carbon, coal, and kerogen in sediments and soils: Mechanisms and consequences for distribution, bioaccumulation, and biodegradation. *Environ Sci Technol* 39(18):6881–6895.
- Cornelissen G, Breedveld GD, Kalaitzidis S, Christanis K, Kibsgaard A, Oen AMP. 2006. Strong sorption of native PAHs to pyrogenic and unburned carbonaceous geosorbents in sediments. *Environ Sci Technol* 40(4): 1197–1203.
- Cornelissen G, Pettersen A, Broman D, Mayer P, Breedveld GD. 2008a. Field testing of equilibrium passive samplers to determine freely dissolved native polycyclic aromatic hydrocarbon concentrations. *Environ Toxicol Chem* 27(3):499–508.
- Cornelissen G, Wiberg K, Broman D, Arp HP, Persson Y, Sundqvist K, Jonsson P. 2008b. Freely dissolved concentrations and sediment-water activity ratios of PCDD/Fs and PCBs in the open Baltic Sea. *Environ Sci Technol* 42(23):8733–8739.
- Cornelissen G, Cousins IT, Wiberg K, Tysklind M, Holmström H, Broman D. 2008c. Black carbon-dominated PCDD/Fs sorption to soils at a former wood impregnation site. *Chemosphere* 72:1455–1461.
- Costello DM, Burton GA, Hammerschmidt CR, Rogevich EC, Schlegel CE. 2011. Nickel phase partitioning and toxicity in field-deployed sediments. *Environ Sci Technol* 45:5798–5805.
- Costello DM, Burton GA, Hammerschmidt CR, Taulbee WK. 2012. Evaluating the performance of diffusive gradients in thin films for predicting Ni sediment toxicity. *Environ Sci Technol* 46:10239–10246.
- Dabrin A, Durand CL, Garric J, Geffard O, Ferrari BJD, Coquery M. 2012. Coupling geochemical and biological approaches to assess the availability of cadmium in freshwater sediment. *Sci Total Environ* 424:308–315.

- Daskalakis KD, TP O'Connor. 1995. Distribution of chemical concentrations in US coastal and estuarine sediment. *Mar Environ Res* 40:381–398.
- Davison W, Zhang H. 1994. In situ speciation measurements of trace components in natural waters using thin-film gels. *Nature* 367:546–548.
- Degryse F, Smolders E, Zhang H, Davison W. 2009. Predicting availability of mineral elements to plants with the DGT technique: A review of experimental data and interpretation by modelling. *Environ Chem* 6:198–218.
- Dickson KL, Maki AW, Brungs WA. 1987. *Fate and Effects of Sediment-Bound Chemicals in Aquatic Systems*. Pergamon Press, New York.
- DiFilippo EL, Eganhouse RP. 2010. Assessment of PDMS-water partition coefficients: Implications for passive environmental sampling of hydrophobic organic compounds. *Environ Sci Technol* 44(18):6917–6925.
- Di Toro DM, Zarba CS, Hansen DJ, Berry WJ, Swartz RC, Cowan CE, Pavlou SP, Allen HE, Thomas NA, Paquin PR. 1991. Technical basis for establishing sediment quality criteria for nonionic organic chemicals using equilibrium partitioning. *Environ Toxicol Chem* 10(12):1541–1583.
- Di Toro DM, JD Mahony, DJ Hansen, KJ Scott, AR Carlson, G T. Ankley. 1992. Acid volatile sulfide predicts the acute toxicity of cadmium and nickel in sediments. *Environ Sci Technol* 26: 96–101.
- Di Toro, DM, HE Allen, HL Bergman, JS Meyer, PR Paquin, RC Santore. 2001. A biotic ligand model of the acute toxicity of metals. I. Technical basis. *Environ. Tox. Chem.* 20: 2383–2396.
- Dong Z, Lewis CG, Burgess RM, Sine JP. 2015. The Gellyfish: An in-situ equilibrium-based sampler for determining multiple free metal ion concentrations in marine ecosystems. *Environ Toxicol Chem* 34:983–992.
- Environmental Security Technology Certification Program. 2016. *Integrating Passive Sampling Methods into Management of Contaminated Sediment Sites: A Guide for Department of Defence Remedial Project Managers*. ESTCP Project ER-201216. Alexandria, VA.
- Fagervold SK, Chai Y, Davis JW, Wilken M, Cornelissen G, Ghosh U. 2010. Bioaccumulation of polychlorinated dibenzo-p-dioxins/dibenzofurans in *E. fetida* from floodplain soils and the effect of activated carbon amendment. *Environ Sci Technol* 44(14):5546–5552.
- Fernandez LA, Harvey CF, Gschwend PM. 2009a. Using performance reference compounds in polyethylene passive samplers to deduce sediment porewater concentrations for numerous target chemicals. *Environ Sci Technol* 43(23):8888–8894.
- Fernandez LA, MacFarlane JK, Tcaciuc AP, Gschwend PM. 2009b. Measurement of freely dissolved PAH concentrations in sediment beds using passive sampling with low-density polyethylene strips. *Environ Sci Technol* 43(5):1430–1436.
- Fernandez LA, Lao W, Maruya KA, White C, Burgess RM. 2012. Passive sampling to measure baseline dissolved persistent organic pollutant concentrations in the water column of the Palos Verdes Shelf Superfund Site. *Environ Sci Technol* 46:11937–11947.

- Fernandez LA, Lao W, Maruya KA, Burgess RM. 2014. Calculating the diffusive flux of persistent organic pollutants between sediments and the water column on the palos verdes shelf superfund site using polymeric passive samplers. *Environ Sci Technol* 48:3925–3934.
- Feyte S, Tessier A, Gobeil C, and Cossa D. 2010. In situ adsorption of mercury, methylmercury and other elements by iron oxyhydroxides and organic matter in lake sediments. *Appl Geochem* 25:984–995.
- Friedman CL, Burgess RM, Perron MM, Cantwell MG, Ho KT, Lohmann R. 2009. Comparing polychaete bioaccumulation and passive sampler uptake to assess the effects of sediment resuspension on PCB bioavailability. *Environ Sci Technol* 43:2865–2870.
- Ghosh U, Weber AS, Jensen JN, Smith JR. 2000. Relationship between PCB desorption equilibrium, kinetics, and availability during land biotreatment. *Environ Sci Technol* 34(12):2542–2548.
- Ghosh U, Kane Driscoll S, Burgess RM, Jonker M-TO, Reible D, Gobas F, Choi Y, Aplitz SE, Maruya KA, Gala WR, Mortimer M, Beegan C. 2014. Passive sampling methods for contaminated sediments: Practical guidance for selection, calibration, and implementation. *Integr Environ Assess Manag* 10: 210–223.
- Gomez-Eyles JL, Yupanqui C, Beckingham B, Riedel G, Gilmour C, Ghosh U. 2013. Evaluation of biochars and activated carbons for in site remediation of sediments impacted with organics, mercury and methylmercury. *Environ Sci Technol* 47:13721–13729.
- Gschwend PM, MacFarlane JK, Reible DD, Lu X, Hawthorne SB, Nakles DV, Thompson T. 2011. Comparison of polymeric samplers for accurately assessing PCBs in pore waters. *Environ Toxicol Chem* 30(6):1288–1296.
- Gustafsson, Ö., Haghseta F, Chan C, MacFarlane JK, Gschwend PM. 1997. Quantification of the dilute sedimentary soot phase: Implications for PAH speciation and bioavailability. *Environ Sci Technol* 31:203–209.
- Haftka JJ, Govers HA, Parsons JR. 2010. Influence of temperature and origin of dissolved organic matter on the partitioning behavior of polycyclic aromatic hydrocarbons. *Environ Sci Pollut Res Int* 17:1070–1079.
- Hale SE, Martin TJ, Goss KU, Arp HP, Werner D. 2010. Partitioning of organochlorine pesticides from water to polyethylene passive samplers. *Environ Pollut* 158:2511–2517.
- Harper MP, Davison W, Zhang H, Tych W. 1998. Kinetics of metal exchange between solids and solutions in sediments and soils interpreted from DGT measured fluxes. *Geochim Cosmochim Acta* 62:2757–2770.
- Hawker DW, Connell DW. 1988. Octanol-water partition coefficients of polychlorinated biphenyl congeners. *Environ Sci Technol* 22(4):382–387.
- Hawthorne SB, Grabanski CB, Miller DJ, Kreitinger JP. 2005. Solid-phase microextraction measurement of parent and alkyl polycyclic aromatic hydrocarbons in milliliter sediment pore water samples and determination of  $k_{doc}$  values. *Environ Sci Technol* 39:2795–2803.
- Hawthorne SB, Azzolina NA, Neuhauser EF, Kreitinger JP. 2007. Predicting bioavailability of sediment polycyclic aromatic hydrocarbons to *Hyaella azteca* using equilibrium partitioning, supercritical fluid extraction, and pore water concentrations. *Environ Sci Technol* 41:6297–6304.

- Hawthorne SB, Miller DJ, Grabanski CB. 2009. Measuring low picogram per liter concentrations of freely dissolved polychlorinated biphenyls in sediment pore water using passive sampling with polyoxymethylene. *Anal Chem* 81(22):9472–9480.
- Hawthorne SB, Jonker MT, van der Heijden SA, Grabanski CB, Azzolina NA, Miller DJ. 2011. Measuring picogram per liter concentrations of freely dissolved parent and alkyl PAHs (PAH-34), using passive sampling with polyoxymethylene. *Anal Chem* 83(17):6754–6761.
- Hilal SH, Karickhoff SW, Carreira LA. 2004. Prediction of the solubility, activity coefficient and liquid/liquid partition coefficient of organic compounds. *QSAR Comb Sci* 23(9):709–720.
- Hsieh MK, Fu CT, Wu SC. 2011. Simultaneous estimation of glass-water distribution and PDMS-water partition coefficients of hydrophobic organic compounds using simple batch method. *Environ Sci Technol* 45(18):7785–7791.
- Huckins JN, Petty JD, Lebo JA, Almeida FV, Booij K, Alvarez DA, Cranor WL, Clark RC, Mogensen BB. 2002. Development of the permeability/performance reference compound approach for in situ calibration of semi-permeable membrane devices. *Environ Sci Technol* 36(1):85–91.
- Ingersoll C, Dillon T, Biddinger G. 1997. *Ecological Risk Assessment of Contaminated Sediments*. SETAC, Pensacola, FL.
- Jahnke A, P Mayer, MS McLachlan. 2012. Sensitive equilibrium sampling to study polychlorinated biphenyl disposition in baltic sea sediment *Environ Sci Technol* 46:10114–10122.
- Janssen EM, Oen AM, Luoma SN, Luthy RG. 2011. Assessment of field-related influences on polychlorinated biphenyl exposures and sorbent amendment using polychaete bioassays and passive sampler measurements. *Environ Toxicol Chem* 30(1):173–180.
- Jonker MT, Koelmans AA. 2001. Polyoxymethylene solid phase extraction as a partitioning method for hydrophobic organic chemicals in sediment and soot. *Environ Sci Technol* 35(18):3742–3748.
- Jonker MT, Van der Heijden SA. 2007. Bioconcentration factor hydrophobicity cutoff: An artificial phenomenon reconstructed. *Environ Sci Technol* 41:(21)7363–7369.
- Jonker MTO, SA van der Heijden, M Kotte, F Smedes. 2015. Quantifying the effects of temperature and salinity on partitioning of hydrophobic organic chemicals to silicone rubber passive samplers. *Environ Sci Technol* 49:6791–6799.
- Joshi C. 2010. Laboratory Assessment of Bioavailability Reduction of DDx by Sorbent Amendment to Sediment. Master of Science Thesis submitted to the Department of Civil and Environmental Engineering, University of Maryland Baltimore County. Maryland.
- Joyce AS, LM Portis, AN Parks, RM Burgess. 2016. Evaluating the relationship between equilibrium passive sampler uptake and aquatic organism bioaccumulation. *Environ Sci Technol* 50:11437–11451.
- Khalil MF, Ghosh U, Kreitinger JP. 2006. Role of weathered coal tar pitch in the partitioning of polycyclic aromatic hydrocarbons in manufactured gas plant site sediments. *Environ Sci Technol* 40:5681–5687.

- Knutsson J, Rauch S, Morrison GM. 2014. Estimation of Measurement Uncertainties for the DGT Passive Sampler Used for Determination of Copper in Water. *Intern J Anal Chem* 1:1–7.
- Kraaij R, Mayer P, Busser FJM, van het Bolscher M, Seinen W, Tolls J, Belfroid AC. 2002. Measured pore-water concentrations make equilibrium partitioning work a data analysis. *Environ Sci Technol* 37(2):268–274.
- Kreuzeder, A., Santner, J., Zhang, H., Prohaska, T., & Wenzel, W. W. (2015). Uncertainty evaluation of the diffusive gradients in thin films technique. *Environ Sci Technol* 49:1594–1602.
- Kukkonen JV, Mitra S, Landrum PF, Gossiaux DC, Gunnarsson J, Weston D. 2005. The contrasting roles of sedimentary plant-derived carbon and black carbon on sediment-spiked hydrophobic organic contaminant bioavailability to *Diporeia* species and *Lumbriculus variegatus*. *Environ Toxicol Chem* 24(4):877–885.
- Lampert DJ, Sarchet WV, Reible DD. 2011. Assessing the effectiveness of thin-layer sand caps for contaminated sediment management through passive sampling. *Environ Sci Technol* 45(19):8437–8443.
- Lampert DJ, Lu X, Reible DD. 2013. Long-term PAH monitoring results from the Anacostia River active capping demonstration using polydimethylsiloxane (PDMS) fibers. *Environ Sci Processes Impacts* 15(3):554–562.
- Lampert DJ, Thomas C, Reible DD. 2015. Internal and external transport significance for predicting contaminant uptake rates in passive samplers. *Chemosphere* 119:910–916.
- Larsson P. 1985. Contaminated sediments of lakes and oceans act as sources of chlorinated hydrocarbons for release to water and atmosphere. *Nature* 317:347–349.
- Lohmann R, Burgess RM, Cantwell MG, SA Ryba, MacFarlane JK and Gschwend PM. 2004. Dependency of polychlorinated biphenyl and polycyclic aromatic hydrocarbon bioaccumulation in *Mya arenaria* on both water column and sediment bed chemical activities. *Environ. Toxicol. Chem.*, 23:2551–2562.
- Lohmann R, Macfarlane JK, Gschwend PM. 2005. Importance of black carbon to sorption of native PAHs, PCBs, and PCDDs in Boston and New York harbor sediments. *Environ Sci Technol* 39(1):141–148.
- Lohmann R. 2012. Critical review of low-density polyethylene's partitioning and diffusion coefficients for trace organic contaminants and implications for its use as a passive sampler. *Environ Sci Technol* 46(2):606–618.
- Long ER, Chapman PM. 1985. A sediment quality triad: Measures of sediment contamination, toxicity and infaunal community composition in Puget Sound. *Mar Pollut Bull* 16(10):405–415.
- Luthy RG, Aiken GR, Brusseau ML, Cunningham SD, Gschwend PM, Pignatello JJ, Reinhard M, Traina SJ, Weber WJ, Westall JC. 1997. Sequestration of hydrophobic organic contaminants by geosorbents. *Environ Sci Technol* 31(12):3341–3347.
- Lydy MJ, Landrum PF, Oen AMP, Allinson, M, Smedes, F, Harwood AD, Li H, Maruya KA, Liu J. 2014. Passive sampling methods for contaminated sediments: State of the science for organic contaminants. *Integr Environ Assess Manag* 10:167–178.

- Mackay D, Shiu WY, Ma KC. 1992. *Illustrated handbook of physical-chemical properties and environmental fate for organic chemicals*. Lewis Publishers: Boca Raton, FL.
- Maruya KA, Zeng EY, Tsukada D, Bay SM. 2009. A passive sampler based on solid-phase microextraction for quantifying hydrophobic organic contaminants in sediment pore water. *Environ Toxicol Chem* 28(4):733–740.
- Maruya KA, Landrum PF, Burgess RM, Shine JP. 2012. Incorporating contaminant bioavailability into sediment quality assessment frameworks. *Integr Environ Assess Manage* 8(4):659–673.
- Maruya KA, Lao W, Tsukada D, Diehl DW. 2015. A passive sampler based on solid phase microextraction (SPME) for sediment-associated organic pollutants: Comparing freely-dissolved concentration with bioaccumulation. *Chemosphere* 137:192–197.
- Mayer P, Vaes WHJ, Wijnker F, Legierse KCHM, Kraaij R, Tolls J, Hermens JLM. 2000. Sensing dissolved sediment porewater concentrations of persistent and bioaccumulative pollutants using disposable solid-phase microextraction fibers. *Environ Sci Technol* 34(24):5177–5183.
- Mayer P, Tolls J, Hermens JL, Mackay D. 2003. Equilibrium sampling devices. *Environ Sci Technol* 37(9):184A–191A.
- Mayer P, Parkerton TF, Adams RG, Cargill JG, Gan J, Gouin T, Gschwend PM, Hawthorene SB, Helm P, Gesine W, You J, Escher B. 2014. Passive Sampling Methods for Contaminated Sediments: Scientific Rationale Supporting Use of Freely Dissolved Concentrations. *Integr Environ Assess Manage* 10:197–209.
- McDonough KM, Fairey JL, Lowry GV. 2008. Adsorption of polychlorinated biphenyls to activated carbon: equilibrium isotherms and a preliminary assessment of the effect of dissolved organic matter and biofilm loadings. *Water Res* 42, 575–584.
- Meyer JS. 2002. The utility of the terms “bioavailability” and “bioavailable fraction” for metals. *Mar Environ Res* 53:417–423.
- Muijs B, Jonker MT. 2011. Assessing the bioavailability of complex petroleum hydrocarbon mixtures in sediments. *Environ Sci Technol* 45(8):3554–3561.
- Muijs B, Jonker MT. 2012. Does equilibrium passive sampling reflect actual *in situ* bioaccumulation of PAHs and petroleum hydrocarbon mixtures in aquatic worms? *Environ Sci Technol* 46 (2):937–944.
- National Research Council. 1989. *Contaminated Marine Sediments—Ecological Considerations*, Pensacola, FL, SETAC Press, 346 pp.
- Naylor C, Davison W, Motelica-Heino M, Van Den Berg GA. 2004. Simultaneous release of sulfide with Fe, Mn, Ni and Zn in marine harbour sediment measured using a combined metal/sulfide DGT probe. *Sci Total Environ* 328:275–286.
- Oen AM, Janssen EM, Cornelissen G, Breedveld GD, Eek E, Luthy RG. 2011. In situ measurement of PCB pore water concentration profiles in activated carbon-amended sediment using passive samplers. *Environ Sci Technol* 45(9):4053–4059.
- Pagenkopf GK. 1983. Gill surface interaction model for trace-metal toxicity to fishes: Role of complexation, pH, and water hardness. *Environ Sci Technol* 17:342–347.

- Peijnenburg WJGM, Teasdale PR, Reible D, Mondon KJ, Bennett WS, Campbell PGC. 2014. Passive sampling methods for contaminated sediments: State of the science for metals. *Integr Environm Assess Manag* 10(2):179–196.
- Perron MM, Burgess RM, Ho KT, Pelletier MC, Friedman CL, Cantwell MG, Shine JP. 2009. Development and evaluation of reverse polyethylene samplers for marine phase II whole-sediment toxicity identification evaluations. *Environ Toxicol Chem/SETAC* 28(4):749–758.
- Perron MM, Burgess RM, Suuberg EM, Cantwell MG, Pennell KG. 2013a. Performance of passive samplers for monitoring estuarine water column concentrations: 1. Contaminants of concern. *Environ Toxicol Chem* 32(10):2182–2189.
- Perron MM, Burgess RM, Suuberg EM, Cantwell MG, Pennell KG. 2013b. Performance of passive samplers for monitoring estuarine water column concentrations: 2. Emerging contaminants. *Environ. Toxicol. Chem.* 32 (10):2190–2196.
- Pignatello JJ, Xing B. 1995. Mechanisms of slow sorption of organic chemicals to natural particles. *Environ Sci Technol* 30(1):1–11.
- Reible D. 2010. Final report on calibration study, April 26, 2010. University of Texas, Austin, TX 78712. Prepared for US EPA Region 10. Dallas, Texas.
- Reible D, Lotufo G. 2012. Demonstration and evaluation of solid phase microextraction for the assessment of bioavailability and contaminant mobility. ESTCP Project ER-200624. Available from: <http://www.serdp.org/content/download/15533/176851/file/ER-200624-Guidance%20Doc.pdf> Accessed March 2014.
- Reible DD, Lotufo G, Skwarski A, Lampert D, Lu X. 2012. Demonstration and evaluation of solid phase microextraction for the assessment of bioavailability and contaminant mobility - final report. ESTCP Project ER-200624. Available from: <http://www.serdp.org/content/download/15533/176851/file/ER-200624-Guidance%20Doc.pdf> Prepared for the Environmental Security Technology Certification Program. Arlington, VA.
- Reichenberg F, Smedes F, Jonsson JA, Mayer P. 2008. Determining the chemical activity of hydrophobic organic compounds in soil using polymer coated vials. *Chem Cent J* 2:8.
- Roulier J-L, Belaud S, Coquery M. 2010. Comparison of dynamic mobilization of Co, Cd and Pb in sediments using DGT and metal mobility assessed by sequential extraction. *Chemosphere* 79:839–843.
- Roulier J-L, Tusseau-Vuillemin M-H, Coquery M, Geffard O, Garric J. 2008. Measurement of dynamic mobilization of trace metals in sediments using DGT and comparison with bioaccumulation in *Chironomus riparius*: First results of an experimental study. *Chemosphere* 70:925–932.
- Rusina TP, Smedes F, Klanova J, Booij K, Holoubek I. 2007. Polymer selection for passive sampling: A comparison of critical properties. *Chemosphere* 68(7):1344–1351.
- Sacan MT, Ozkul M, Erdem SS. 2005. Physico-chemical properties of PCDD/Fs and phthalate esters. *SAR QSAR Environ Res* 16:443–459.
- Salomons W, de Rooij NM, Kerdijk, Bril J. 1987. Sediments as a source of contaminants? *Hydrobiologia* 149:13–30.



- Santore RC, Di Toro DM, Paquin PR, Allen HE, Meyer JS. 2001. Biotic ligand model of the acute toxicity of metals. 2. Application to acute copper toxicity in freshwater fish and Daphnia. *Environ Toxicol Chem* 20:2397–2402.
- Schwarzenbach RP, Gschwend PM, Imboden DM. 2003. *Environmental Organic Chemistry* 2nd Edition. Wiley-Interscience, New Jersey.
- Senn DB, Griscom SB, Lewis CG, Galvin JP, Chang MW, Shine JP. 2004. Equilibrium-based sampler for determining  $\text{Cu}^{2+}$  concentrations in aquatic ecosystems. *Environ Sci Technol* 38:3381–3386.
- Shiu W-Y, Ma K-C. 2000. Temperature dependence of physical–chemical properties of selected chemicals of environmental interest. II. Chlorobenzenes, polychlorinated biphenyls, polychlorinated dibenzo-p-dioxins, and dibenzofurans. *J Phys Chem Ref Data* 29:387–462.
- Simpson SL, Yverneau H, Cremazy A, Jarolimek CV, Price HL, Jolley DF. 2012. DGT-induced copper flux predicts bio-accumulation and toxicity to bivalves in sediments with varying properties. *Environ Sci Technol* 46:9038–9046.
- Smedes F, Geertsma RW, van der Zande T, Booij K. 2009. Polymer-water partition coefficients of hydrophobic compounds for passive sampling: Application of cosolvent models for validation. *Environ Sci Technol* 43(18):7047–7054.
- Smedes F, Booij K. 2012. Guidelines for passive sampling of hydrophobic contaminants in water using silicone rubber samplers. *ICES Techniques in Marine Environmental Sciences: No. 52*. International Council for the Exploration of the Sea. Copenhagen, Denmark.
- Sochaczewski L, Tych W, Davison B, Zhang H. 2007. 2D DGT induced fluxes in sediments and soils (2D DIFS). *Environ Model Softw* 22:14–23.
- Soriano-Disla JM, Speir TW, Gómez I, Clucas LM, McLaren RG, Navarro-Pedreño J. 2010. Evaluation of different extraction methods for the assessment of heavy metal bioavailability in various soils. *Water Air Soil Pollut* 213:471–483.
- Tankere-Muller S, Zhang H, Davison W, Finke N, Larsen O, Stahl H, Glud RN. 2007. Fine scale remobilisation of Fe, Mn, Co, Ni, Cu and Cd in contaminated marine sediment. *Mar Chem* 106:192–207.
- Tcaciuc AP, JN Apell and PM Gschwend. 2014. Passive Sampler PRC Calculation Software and User's Guide. Available at <https://www.serdp-estcp.org/Program-Areas/Environmental-Restoration/Contaminated-Sediments/ER-200915>.
- ter Laak TL, Barendregt A, Hermens JL. 2006. Freely dissolved pore water concentrations and sorption coefficients of PAHs in spiked, aged, and field-contaminated soils. *Environ Sci Technol* 40(7):2184–2190.
- Thomas C, Lampert D, Reible D. 2014. Remedy performance monitoring at contaminated sediment sites using profiling solid phase microextraction (SPME) polydimethylsiloxane (PDMS) fibers. *Environ Sci: Pro Impacts* 16:445–452.
- Tomaszewski JE, Luthy RG. 2008. Field deployment of polyethylene devices to measure PCB concentrations in pore water of contaminated sediment. *Environ Sci Technol* 42(16):6086–6091.

Turner GSC, Mills GA, Bowes MJ, Burnett JL, Amos S, Fones GR. 2014. Evaluation of DGT as a long-term water quality monitoring tool in natural waters; uranium as a case study. *Environ Sci: Proc Impacts* 16(3):393.

Tusseau-Vuillemin M-H, Gilbin R, Bakkaus E, Garric J. 2004. Performance of diffusion gradient in thin films to evaluate the toxic fraction of copper to *Daphnia magna*. *Environ Toxicol Chem* 23:2154–2161.

United States Environmental Protection Agency. 1996a. *EMAP – Estuaries Virginian Province Data 1990-1993*. <http://www.epa.gov/emap>. Office of Research and Development, Washington, DC.

United States Environmental Protection Agency. 1996b. *EMAP – Estuaries Louisianian Province Data 1991-1993*. <http://www.epa.gov/emap>. Office of Research and Development, Washington, DC.

United States Environmental Protection Agency. 1997a. *The Incidence and Severity of Sediment Contamination in Surface Waters of the United States, Volume 1: National Sediment Quality Survey*. EPA/823/R-97/006, Office of Water. Washington, DC.

United States Environmental Protection Agency. 1997b. *The Incidence and Severity of Sediment Contamination in Surface Waters of the United States, Volume 2: Data Summaries of Areas of Probable Concern*. EPA/823/R-97/007, Office of Water. Washington, DC.

United States Environmental Protection Agency. 1997c. *The Incidence and Severity of Sediment Contamination in Surface Waters of the United States, Volume 3: National Sediment Contamination Point Source Inventory*. EPA/823/R-97/008, Office of Water. Washington, DC.

United States Environmental Protection Agency. 1998. *EMAP – Estuaries Carolinian Province Data 1990–1993*. <http://www.epa.gov/emap>. Office of Research and Development. Washington, DC.

United States Environmental Protection Agency. 2003. *Procedures for the Derivation of Equilibrium Partitioning Sediment Benchmarks (ESBs) for the Protection of Benthic Organisms: PAH Mixtures*. EPA-600-R-02-013. Office of Research and Development. Washington, DC.

United States Environmental Protection Agency. 2004. *The Incidence and Severity of Sediment Contamination in Surface Waters of the United States, National Sediment Quality Inventory: Second Edition*. EPA-823-R-04-007. Office of Water. Washington DC.

United States Environmental Protection Agency. 2005a. *Contaminated Sediment Remediation Guidance for Hazardous Waste Sites*. EPA/540/R-05/012. Office of Solid Waste and Emergency Response. Washington, DC.

United States Environmental Protection Agency. 2005b. *Procedures for the Derivation of Equilibrium Partitioning Sediment Benchmarks (ESBs) for The Protection of Benthic Organisms: Metals Mixtures (Cadmium, Copper, Lead, Nickel, Silver and Zinc)*. EPA-600-R-02-011. Office of Research and Development. Washington, DC.

United States Environmental Protection Agency. 2005c. *Uniform Federal Policy for Quality Assurance Project Plans: Evaluating, Assessing, and Documenting Environmental Data Collection and Use Program*. EPA-505-B-04-900A. Intergovernmental Data Quality Task Force.

- United States Environmental Protection Agency. 2008. *Procedures for the Derivation of Equilibrium Partitioning Sediment Benchmarks (ESBs) for The Protection of Benthic Organisms: Compendium of Tier 2 Values for Nonionic Organics*. EPA-600-R-02-016. Office of Research and Development. Washington, DC.
- United States Environmental Protection Agency. 2012a. *Equilibrium Partitioning Sediment Benchmarks (ESBs) for the Protection of Benthic Organisms: Procedures for the Determination of the Freely Dissolved Interstitial Water Concentrations of Nonionic Organics*. EPA-600-R-02-012. Office of Research and Development. Washington, DC.
- United States Environmental Protection Agency. 2012b. *Guidelines for Using Passive Samplers to Monitor Nonionic Organic Contaminants at Superfund Sediment Sites. Sediment Assessment and Monitoring Sheet (SAMS) #3*. OSWER Directive 9200.1-110 FS. Office of Superfund Remediation and Technology Innovation/Office of Research and Development. Washington, DC.
- Uribe R, Mongin S, Puy J, Cecília J, Galceran J, Zhang H, Davison W. 2011. Contribution of partially labile complexes to the DGT metal flux. *Environ Sci Technol* 45:5317–5322.
- van der Geest HG, León Paumen M. 2008. Dynamics of metal availability and toxicity in historically polluted floodplain sediments. *Sci Total Environ* 406(3):419–425.
- van der Heijden SA, Jonker MT. 2009. PAH bioavailability in field sediments: comparing different methods for predicting *in situ* bioaccumulation. *Environ Sci Technol* 43(10):3757–3763.
- van der Veeken PLR, Chakraborty P, Leeuwen HPV. 2010. Accumulation of humic acid in DET/DGT gels. *Environ Sci Technol* 44:4253–4257.
- Villanueva JD, Le Coustumer P, Huneau F, Motelica-Heino M, Perez TR, Materum R, Stoll S. 2013. Assessment of trace metals during episodic events using DGT passive sampler: A proposal for water management enhancement. *Wat Res Manage* 27:4163–4181.
- Vinturella AE, Burgess RM, Coull BA, Thompson KM, Shine JP. 2004. Use of passive samplers to mimic uptake of polycyclic aromatic hydrocarbons by benthic polychaetes. *Environ Sci Technol* 38(4):1154–1160.
- Vrana B, Allan IJ, Greenwood R, Mills GA, Dominiak E, Svensson K, Knutsson J, Morrison G. 2005. Passive sampling techniques for monitoring pollutants in water. *TrAC* 24(10):845–868.
- Warnken KW, H. Zhang, and W. Davison. 2006. Accuracy of the diffusive gradients in thin-films technique: diffusive boundary layer and effective sampling area considerations. *Anal Chem* 78(11):3780–3787.
- Warnken KW, Davison W, and Zhang H. 2008. Interpretation of *in situ* speciation measurements of inorganic and organically complexed trace metals in freshwater by DGT. *Environ Sci Technol* 42:6903–6909.
- Wenning RJ, Batley GE, Ingersoll CG, Moore DW. 2005. *Use of Sediment Quality Guidelines and Related Tools for the Assessment of Contaminated Sediments*. SETAC, Pensacola, FL.

Witt G, Liehr GA, Borck D, Mayer P. 2009. Matrix solid-phase microextraction for measuring freely dissolved concentrations and chemical activities of PAHs in sediment cores from the western Baltic Sea. *Chemosphere* 74(4):522–529.

Witt G, Lang S-C, Ullmann D, Schaffrath G, Schulz-Bull D, Mayer P. 2013. Passive Equilibrium sampler for *in situ* measurements of freely dissolved concentrations of hydrophobic organic chemicals in sediments. *Environ Sci Technol* 47:7830–7839.

Zhang H, Davison W. 1995. Performance characteristics of the technique of diffusion gradients in thin-films (DGT) for the measurement of trace metals in aqueous solution. *Anal Chem* 67:3391–3400.

Zhang H, Davison W, Miller S, Tych W. 1995. *In situ* high resolution measurements of fluxes of Ni, Cu, Fe, and Mn and concentrations of Zn and Cd in porewaters by DGT. *Geochim Cosmochim Acta* 59:4181–4192.

Zhang H. 2004. *In-situ* speciation of Ni and Zn in freshwaters: Comparison between DGT measurements and speciation models. *Environ Sci Technol* 38:1421–1427.

Zhang H., Zhao FJ, Sun B, Davison W, McGrath SP. 2001. A new method to measure effective soil solution concentration predicts copper availability to plants. *Environ Sci Technol* 35(12): 2602–2607.

Zimmerman JR, Ghosh U, Millward RN, Bridges TS, Luthy RG. 2004. Addition of carbon sorbents to reduce PCB and PAH bioavailability in marine sediments: Physicochemical tests. *Environ Sci Technol* 38:5458–5664.

# Appendix A: Passive Sampler Partition Coefficients ( $K_{PS}$ ) for PCBs and PAHs

Polymer-water partition coefficients,  $K_{PS}$ , for PCBs and PAHs using the different passive sampling materials including PDMS, PE, and POM were published in proceedings from a workshop on passive samplers (Ghosh et al. 2014).  $K_{PDMS}$  values are based on the PDMS film J-Flex SR-TF from Smedes et al. (2009) and are consistent with PDMS coated fibers reported by Hsieh et al. (2011) and DiFilippo and Eganhouse (2010).  $K_{LDPE}$  values are from Smedes et al. (2009) and  $K_{POM}$  values are from Hawthorne et al. (2011). Regarding log  $K_{OW}$ s,

specific sources of values are described in Tables A-1 and A-2. The uncertainty in the log  $K_{OW}$  values is approximately a factor of two (i.e., 0.3 log units) from the different sources (e.g., Hilal et al. 2004; Mackay et al. 1992). When using the correlations between log  $K_{OW}$  and log  $K_{PS}$  discussed in Sections 2, 3 and 4 to generate new  $K_{PS}$  values, it is important to use the same source of log  $K_{OW}$  as used to derive the correlations.

**Table A-1. Provisional partition coefficients ( $K_{PS}$ ) (mL/g) for selected PCB congeners. Log  $K_{OW}$  values for PCB congeners are from Hawker and Connell (1988). Values reported are log mean  $\pm$  log standard error.**

Congener	Log $K_{OW}$	$K_{PDMS}^a$	Log $K_{LDPE}$	Log $K_{POM}$
CB4	4.65	4.39 $\pm$ 0.09	4.19 $\pm$ 0.12	4.57 $\pm$ 0.10
CB10	4.84	4.38 $\pm$ 0.09	4.23 $\pm$ 0.12	
CB14	5.28	4.82 $\pm$ 0.06	4.99 $\pm$ 0.11	
CB18	5.24	4.99 $\pm$ 0.08	4.9 $\pm$ 0.12	5.12 $\pm$ 0.07
CB21	5.51	5.13 $\pm$ 0.07	5.22 $\pm$ 0.11	
CB28	5.67	5.23 $\pm$ 0.06	5.4 $\pm$ 0.12	5.68 $\pm$ 0.09
CB29	5.60	5.16 $\pm$ 0.04	5.31 $\pm$ 0.07	
CB30	5.44	5.06 $\pm$ 0.06	5.13 $\pm$ 0.09	
CB31	5.67	5.20 $\pm$ 0.06	5.3 $\pm$ 0.10	5.51 $\pm$ 0.04
CB44	5.75	5.52 $\pm$ 0.06	5.48 $\pm$ 0.10	5.65 $\pm$ 0.07
CB47	5.85	5.53 $\pm$ 0.06	5.62 $\pm$ 0.10	5.59 $\pm$ 0.2
CB49	5.85	5.61 $\pm$ 0.05	5.67 $\pm$ 0.10	5.83 $\pm$ 0.06
CB50	5.63	5.51 $\pm$ 0.06	5.52 $\pm$ 0.09	
CB52	5.84	5.54 $\pm$ 0.06	5.55 $\pm$ 0.10	5.65 $\pm$ 0.06
CB55	6.11	5.65 $\pm$ 0.05	5.82 $\pm$ 0.09	
CB56	6.11	5.71 $\pm$ 0.07	5.9 $\pm$ 0.09	6.19 $\pm$ 0.21
CB66	6.20	5.69 $\pm$ 0.05	5.95 $\pm$ 0.09	6.08 $\pm$ 0.08

Congener	Log K <sub>ow</sub>	K <sub>PDMS</sub> <sup>a</sup>	Log K <sub>LDPE</sub>	Log K <sub>POM</sub>
CB78	6.35	5.67±0.06	6.03±0.08	
CB85	6.30	5.93±0.13	6.14±0.13	6.07±0.16
CB87	6.29	6.04±0.07	6.18±0.09	
CB97	6.29	5.93±0.06	6.1±0.06	6.23±0.2
CB99	6.39	6.10±0.06	6.38±0.06	6.17±0.04
CB101	6.38	6.01±0.06	6.18±0.07	
CB104	5.81	6.01±0.07	6.00±0.08	
CB105	6.65	6.07±0.07	6.44±0.08	6.38
CB110	6.48	6.02±0.07	6.16±0.09	6.2±0.11
CB118	6.74	6.09±0.06	6.53±0.06	6.32±0.14
CB128	6.74	6.44±0.07	6.74±0.07	6.35±0.24
CB137	6.83	6.54±0.06	6.93±0.05	
CB138	6.83	6.46±0.06	6.82±0.05	6.5
CB141	6.82	6.41±0.08	6.74±0.09	6.42±0.06
CB145	6.25	6.48±0.06	6.52±0.07	
CB149	6.67	6.40±0.07	6.59±0.08	6.11±0.22
CB151	6.64	6.38±0.09	6.55±0.10	6.25±0.26
CB153	6.92	6.45±0.08	6.81±0.08	6.64±0.19
CB155	6.41	6.63±0.07	6.88±0.07	
CB156	7.18	6.40±0.10	6.96±0.10	6.59
CB170	7.27	6.80±0.15	7.25±0.14	6.54
CB180	7.36	6.72±0.17	7.24±0.17	6.67±0.09
CB187	7.17	6.66±0.13	7.01±0.13	6.44±0.08
CB204	7.30	7.42±0.33	7.77±0.33	

<sup>a</sup> Based on J-Flex SR-TF form of PDMS

**Table A-2. Provisional partition coefficients ( $K_{ps}$ ) (mL/g) for selected PAHs. Log  $K_{ow}$  values for PAHs are from the SPARC program based on concepts discussed in Hilal et al. (2004). Values reported are log mean  $\pm$  log standard error.**

Compound	Log $K_{ow}$ <sup>a</sup>	$K_{PDMS}$ <sup>b</sup>	$K_{LDPE}$	$K_{POM}$
Naphthalene	3.41	2.9 $\pm$ 0.07	2.81 $\pm$ 0.14	3.05 $\pm$ 0.09
Acenaphthylene	3.71	3.07 $\pm$ 0.08	3.16 $\pm$ 0.14	3.78 $\pm$ 0.06
Acenaphthene	4.06	3.45 $\pm$ 0.06	3.62 $\pm$ 0.12	3.5 $\pm$ 0.04
Fluorene	4.20	3.58 $\pm$ 0.06	3.77 $\pm$ 0.11	3.83 $\pm$ 0.12
Phenanthrene	4.74	3.83 $\pm$ 0.05	4.22 $\pm$ 0.11	4.2 $\pm$ 0.07
Anthracene	4.69	3.91 $\pm$ 0.04	4.33 $\pm$ 0.12	4.31 $\pm$ 0.09
Fluoranthene	5.29	4.29 $\pm$ 0.03	4.93 $\pm$ 0.09	4.54 $\pm$ 0.09
Pyrene	5.25	4.38 $\pm$ 0.04	5.1 $\pm$ 0.07	4.55 $\pm$ 0.09
Chrysene	5.90	4.8 $\pm$ 0.05	5.78 $\pm$ 0.09	5.44 $\pm$ 0.12
Benz[a]anthracene	5.85	4.84 $\pm$ 0.04	5.73 $\pm$ 0.11	5.47 $\pm$ 0.1
Benz[a]pyrene	6.54	5.22 $\pm$ 0.04	6.75 $\pm$ 0.05	5.96 $\pm$ 0.03
Benz[b]fluoranthene	6.58			5.8 $\pm$ 0.03
Benz[k]fluoranthene	6.50	5.26 $\pm$ 0.02	6.66 $\pm$ 0.05	5.94 $\pm$ 0.04
Benzo[ghi]perylene	7.04	5.6 $\pm$ 0.13	7.27 $\pm$ 0.14	6.1 $\pm$ 0.09
Indeno[1,2,3-cd]pyrene	7.09	5.59 $\pm$ 0.19	7.4 $\pm$ 0.17	6.31 $\pm$ 0.1
Dibenz[a,h]anthracene	7.39	5.68 $\pm$ 0.14	7.32 $\pm$ 0.13	6.3 $\pm$ 0.12

<sup>a</sup> SPARC log  $K_{ow}$  values may change with updates to the SPARC software (<http://archemcalc.com/sparc-web/calc>) and it is critical to record the date SPARC was used to generate log  $K_{ow}$  values. Values reported in this table were generated in June 2014.

<sup>b</sup> Based on J-Flex SR-TF form of PDMS.

The polymer-water partition coefficients are dependent on the hydrophobicity of the target contaminant and the passive sampling material, but not on the amount of sorbent or its dimensions (if equilibrium was attained). Thick layers of sorbent may result in slow achievement of equilibrium, and the lack of equilibrium may be the cause of some reported  $K_{PS}$  that are lower than those shown in the appendix. Some effects of the manufacture and processing of the different polymers have been noted particularly in PDMS (Ghosh et al. 2014). Consistent deviations of 0.1–0.3 log units have been noted; for example, between PDMS from different manufacturers (Smedes et al. 2009). The larger deviations are noted for the more hydrophobic compounds (e.g., highly chlorinated PCBs). There are also occasional wide variations in reported  $K_{PS}$  for PDMS, particularly for highly hydrophobic compounds, which are exceedingly difficult to measure. Often, measurements have been reported that are somewhat lower than for  $K_{PS}$  for highly hydrophobic target contaminants due to the difficulty in achieving equilibrium with these compounds and the potential for losses of the contaminants to phases other than the polymer sorbent during measurement. The values presented here represent the best values available, and the reader is cautioned that attempts to refine these values for a particular polymer sorbent and contaminants should be undertaken only by experienced analysts recognizing the problems involved.

There is also evidence that the values of  $K_{PS}$  are dependent on the temperature and salinity of the aquatic system being measured. Most  $K_{PS}$  values are derived at 20–25°C and in deionized water. These variations are relatively small compared to other sources of uncertainty over the modest range of environmental temperatures typically of interest (~5–25°C) and with salinities up to the salinity of seawater. See Appendix C for further discussion.

The estimated values of  $K_{PS}$  are expected to be accurate within approximately 0.3 log units (factor of two), even for highly hydrophobic compounds and for different sorbent sources. The resulting error in  $K_{PS}$  is similar in magnitude to other environmental partition coefficients (e.g., the octanol-water partition coefficients ( $K_{OW}$ )). Like other environmental sampling approaches, the uncertainty in interstitial water or overlying water concentrations derived from  $K_{PS}$  values is also likely to be dominated by the uncertainty in whether a particular sample is representative of environmental conditions, rather than the specific value of  $K_{PS}$ .



# Appendix B: Additional Passive Sampler Partition Coefficient Information

When using the correlations between  $\log K_{OW}$  and  $\log K_{PS}$  discussed in Sections 2, 3 and 4 to generate new  $K_{PS}$  values, it is important to use the same source of  $\log K_{OW}$  as used to derive the correlations. The uncertainty in the  $\log K_{OW}$  values is approximately a factor of two (i.e., 0.3 log units) from the different sources (e.g., Hilal et al. 2004; Mackay et al. 1992).

## B.1 Polyoxymethylene

### B.1.1 Polychlorinated Biphenyls

For PCB congeners,  $K_{POM}$  values are close to  $K_{OW}$  values, as shown in Figure B-1 (Beckingham and Ghosh 2011). Table B-1 provides a comparison of  $K_{POM}$  values reported by a range of researchers using different thicknesses of POM. The  $K_{POM}$  values for the 500- $\mu\text{m}$ -thick POM were much smaller than the  $K_{POM}$  values reported subsequently for the thinner POM, likely indicating that the thicker POM did not come to equilibrium during a typical loading time frame. Much of the subsequent work with POM in the last five years has focused on the commercially-available 76  $\mu\text{m}$ -thick POM films.

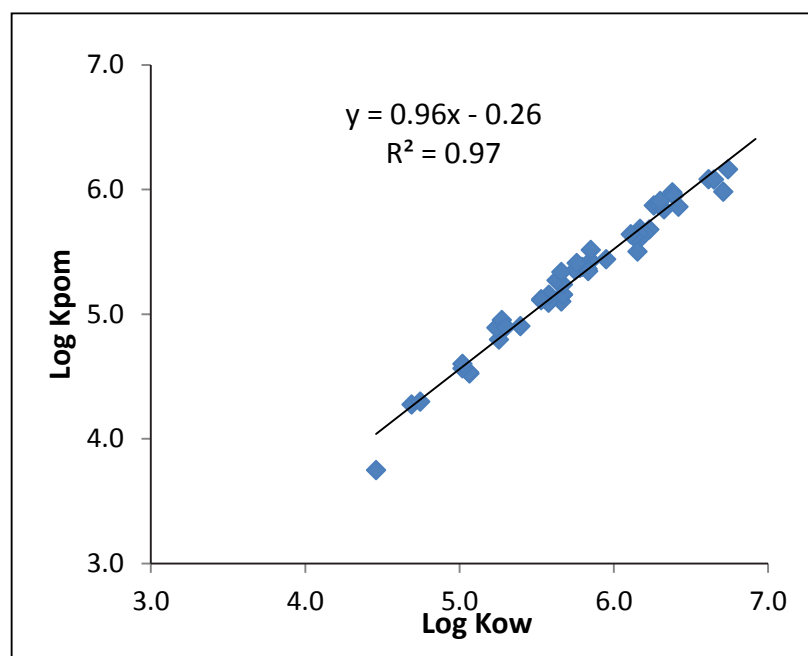

Figure B-1. Relationship between  $\log K_{POM}$  versus  $\log K_{OW}$  for several PCB congeners (Beckingham and Ghosh 2011).

**Table B-1. Comparison of  $K_{POM}$  values for selected CB congeners reported by different researchers. Values shown are the mean  $\pm$  the standard deviation (SD).**

Target Contaminant	Log $K_{ow}$ <sup>a</sup>	Log $K_{POM}$ (L/Kg)					
		Polymer Thickness ( $\mu\text{m}$ )					
		76 <sup>b</sup>	76 <sup>c</sup>	76 <sup>d</sup>	55 <sup>e</sup>	500 <sup>f</sup>	500 <sup>g</sup>
CB18	5.24	4.77	5.06 $\pm$ 0.08	5.12 $\pm$ 0.05	4.83 $\pm$ 0.04	3.90 $\pm$ 0.05	3.84 $\pm$ 0.13
CB19	5.02		4.63 $\pm$ 0.30				
CB22	5.58	5.10	5.34 $\pm$ 0.05	5.40 $\pm$ 0.06			
CB25	5.67		5.16 $\pm$ 0.21 <sup>f</sup>				
CB26	5.66	5.17	5.23 $\pm$ 0.12	5.41 $\pm$ 0.01			
CB28	5.67	5.18	5.33 $\pm$ 0.13	5.68 $\pm$ 0.06	5.09 $\pm$ 0.08	4.41 $\pm$ 0.05	
CB31	5.67	5.18	5.27 $\pm$ 0.12	5.51 $\pm$ 0.04			
CB40	5.66		5.81 $\pm$ 0.37				
CB42	5.76	5.27	5.76 $\pm$ 0.38	5.64 $\pm$ 0.12			
CB44	5.75	5.26	5.58 $\pm$ 0.16	5.65 $\pm$ 0.05			
CB45	5.53	5.05	5.69 $\pm$ 0.33	5.31 $\pm$ 0.03			
CB47	5.85	5.36	6.01 $\pm$ 0.46	5.59 $\pm$ 0.13			
CB51	5.63		5.32 $\pm$ 0.19				
CB64	5.95	5.45	5.62 $\pm$ 0.15	5.80 $\pm$ 0.02			
CB74	6.20	5.69	5.90 $\pm$ 0.23	6.13 $\pm$ 0.06			
CB83	6.26		5.82 $\pm$ 0.89 <sup>h</sup>				
CB91	6.13		5.32 $\pm$ 0.34 <sup>h</sup>				
CB97	6.29	5.78	5.93 <sup>h</sup>	6.23 $\pm$ 0.18			
CB99	6.39	5.87	6.78 $\pm$ 0.47 <sup>h</sup>	6.17 $\pm$ 0.04			
CB101	6.38	5.86	6.32 <sup>h</sup>	5.90 $\pm$ 0.04	5.93 $\pm$ 0.14	4.91 $\pm$ 0.10	
CB118	6.74		6.24 <sup>h</sup>	6.32 $\pm$ 0.14	6.32 $\pm$ 0.13	5.05 $\pm$ 0.08	

<sup>a</sup> Hawker and Connell (1988)

<sup>b</sup> Beckingham and Ghosh (2011)

<sup>c</sup> Hale et al. (2010)

<sup>d</sup> Hawthorne et al. (2009)

<sup>e</sup> Cornelissen et al. (2008b)

<sup>f</sup> Jonker and Koelmans (2001)

<sup>g</sup> McDonough et al. (2008)

<sup>h</sup> Compounds where the aqueous phase concentration was below the limit of detection for two or more of the four spiking concentrations

### *B.1.2 Polycyclic Aromatic Hydrocarbons*

Like CBs, several researchers have reported a range of  $K_{POM}$  values for PAHs as listed in Table B-2. Recent reports using thinner sheets of POM (55 and 76  $\mu\text{m}$ ) are more consistent and reliable compared to the earlier reports, especially with the thick sheets (500  $\mu\text{m}$ ) of POM due to uncertainties about reaching equilibrium.

### *B.1.3 DDT and other Chlorinated Pesticides*

Joshi (2010) used POM passive sampling to quantify  $C_{\text{free}}$  of DDTs and its degradation products (i.e., DDx) in sediment interstitial water. Sorption of DDx to POM was determined by measuring sorption isotherms at four different DDx concentrations. For all DDx compounds, the isotherms are linear, with an  $r^2 > 0.8$ . The averaged  $\log K_{POM}$  values ( $\pm$  standard deviation [SDs]), are given in Table B-3.

### *B.1.4 Dioxins and Furans*

Relatively few reports are available for the use of POM for the measurement of interstitial water concentrations of dioxins and furans. Cornelissen et al. (2008b) described the binding of dioxins and furans in soil at a former wood treatment site using POM. They reported the  $\log K_{POM}$  values for dioxins and furans, shown in Table B-4. Fagervold et al. (2010) used correlated with bioaccumulation by earthworms.

**Table B-2. Comparison of  $K_{POM}$  values for selected PAHs reported by different researchers. Values shown are the mean  $\pm$  the standard deviation (SD).**

Target Contaminant	Log $K_{ow}$ <sup>a</sup>	Log $K_{POM}$ (L/Kg)		
		Polymer Thickness ( $\mu$ m)		
		500 <sup>b</sup>	55 <sup>b</sup>	500 <sup>c</sup>
Naphthalene	3.41	2.6 $\pm$ 0.4	2.59 $\pm$ 0.14	-
Fluorene	4.20	2.94 $\pm$ 0.15	3.33 $\pm$ 0.10	-
Phenanthrene	4.74	3.21 $\pm$ 0.13	3.56 $\pm$ 0.07	3.29 $\pm$ 0.07
Anthracene	4.69	3.42 $\pm$ 0.12	3.8 $\pm$ 0.03	3.47 $\pm$ 0.10
Fluoranthene	5.29	3.67 $\pm$ 0.16	4.03 $\pm$ 0.06	3.73 $\pm$ 0.04
Pyrene	5.25		4.04 $\pm$ 0.07	
Benz[a]anthracene	5.85	4.33 $\pm$ 0.13	4.64 $\pm$ 0.13	4.51 $\pm$ 0.07
Chrysene	5.90	4.27 $\pm$ 0.15	4.51 $\pm$ 0.16	4.51 $\pm$ 0.09
Benz[b]fluoranthene	6.58	4.53 $\pm$ 0.11	4.81 $\pm$ 0.10	4.88 $\pm$ 0.13
Benz[k]fluoranthene	6.50		4.84 $\pm$ 0.08	
Benz[e]pyrene	-		4.87 $\pm$ 0.08	
Benz[a]pyrene	6.54		4.8 $\pm$ 0.2	
Benzo[ghi]perylene	7.04		4.92 $\pm$ 0.06	
Indeno[1,2,3-cd]pyrene	7.09		4.84 $\pm$ 0.05	

<sup>a</sup> Based on SPARC software (<http://archemcalc.com/sparc-web/calc>) in June 2014

<sup>b</sup> Cornelissen et al. (2008b)

<sup>c</sup> Jonkers and Koelmans (2001)

**Table B-3.  $K_{POM}$  values for selected DDTs and degradation products (DDxs) reported by Joshi (2010). Values shown are the mean  $\pm$  the standard deviation.**

Target Contaminant	Log $K_{ow}$ <sup>a</sup>	Log $K_{POM}$ (L/Kg)
4, 4' DDE	6.51	6.3 $\pm$ 0.4
2, 4'-DDD	6.00	5.8 $\pm$ 0.4
4, 4'-DDD	6.02	5.9 $\pm$ 0.4
2, 4'-DDT	6.79	6.0 $\pm$ 0.4
4,4'-DDT	6.91	6.0 $\pm$ 0.4

<sup>a</sup> Based on US Department of Health and Human Services, Toxicological Profile for DDT, DDE, and DDD ATSDR, September 2002, <http://www.atsdr.cdc.gov/ToxProfiles/tp35.pdf>.

**Table B-4. Log  $K_{POM}$  values for selected dioxins and furans reported by Cornelissen et al. (2008b,c, 2010). Values shown are the mean  $\pm$  the standard deviation.**

Target Contaminant	Log $K_{ow}$ <sup>a</sup>	Log $K_{POM}$ (L/Kg)	
		Cornelissen et al. (2008b)	Cornelissen et al. (2008c, 2010)
2-MCDF	5.3		
2,8-DCDF	5.5	5.32 $\pm$ 0.09 <sup>b</sup>	
1,6-DCDD	6.2	5.24 $\pm$ 0.07 <sup>b</sup>	
2,4,8-TCDF	6.9	5.65 $\pm$ 0.09 <sup>b</sup>	
1,3,6,8-TCDF	6.5	5.78 $\pm$ 0.35 <sup>b</sup>	
2,3,7,8-TCDF	6.41		5.74 <sup>b</sup>
2,3,7,8-TCDD	7.05		5.86 <sup>b</sup>
1,3,6,8-TCDD	6.8	5.79 $\pm$ 0.35 <sup>b</sup>	
1,2,3,7,8-PCDF	6.74		5.87 <sup>b</sup>
1,2,3,7,8-PCDD	7.06		6.00 <sup>b</sup>
1,2,3,8,9-PCDF	7.4	5.99 $\pm$ 0.43 <sup>b</sup>	
2,3,4,7,8-PCDF	6.8		5.90 <sup>b</sup>
1,2,3,4,6,9-HCDD	7.8	6.40 $\pm$ 0.32 <sup>b</sup>	
1,2,3,4,7,8-HCDF	7.46		6.00 <sup>b</sup>
1,2,3,4,7,8-HCDD	7.93		6.10 <sup>b</sup>
1,2,3,6,7,8-HCDF	7.56		6.01 <sup>b</sup>
1,2,3,6,7,8-HCDD	7.93		6.11 <sup>b</sup>
1,2,3,7,8,9-HCDF	7.44		6.06 <sup>b</sup>
1,2,3,7,8,9-HCDD	7.91		6.09 <sup>b</sup>
2,3,4,6,7,8-HCDF	7.43		6.03 <sup>b</sup>
1,2,3,4,6,7,8-HCDF	7.81		6.12 <sup>b</sup>
1,2,3,4,6,7,8-HCDD	8.42		6.21 <sup>b</sup>
1,2,3,4,6,7,9-HCDD	8	6.30 $\pm$ 0.29 <sup>b</sup>	
1,2,3,4,7,8,9-HCDF	7.92		6.17 <sup>b</sup>
OCDF	8.43	6.33 <sup>c</sup>	6.26 <sup>b</sup>
OCDD	8.85	6.46 <sup>c</sup>	6.30 <sup>b</sup>

<sup>a</sup> Based on Sacan et al. (2005)

<sup>b</sup> Measured values

<sup>c</sup> Extrapolated values

## B.2 Polydimethylsiloxane

### B.2.1 Polychlorinated Biphenyls and Polycyclic Aromatic Hydrocarbons

Tables B-5 and B-6 report alternative  $K_{PDMS}$  values for PCBs and PAHs. Other alternative sources of  $K_{PDMS}$  values not explicitly reported here include Reible and Lotufo (2012), Reible et al. (2012) and DiFilippo and Eaganhouse (2010).

**Table B-5.  $K_{PDMS}$  for selected PCB congeners using the Altel Sil sheet form of PDMS. Values reported are log mean  $\pm$  standard error.**

Target Contaminant	Log $K_{ow}$ <sup>a</sup>	Log $K_{PDMS}$ <sup>b</sup>
CB4	4.65	4.58 $\pm$ 0.09
CB10	4.84	4.55 $\pm$ 0.08
CB14	5.28	5.15 $\pm$ 0.03
CB18	5.24	5.24 $\pm$ 0.08
CB21	5.51	5.43 $\pm$ 0.06
CB28	5.67	5.54 $\pm$ 0.06
CB29	5.60	5.44 $\pm$ 0.04
CB30	5.44	5.25 $\pm$ 0.05
CB31	5.67	5.5 $\pm$ 0.06
CB44	5.75	5.82 $\pm$ 0.08
CB47	5.85	5.79 $\pm$ 0.08
CB49	5.85	5.89 $\pm$ 0.07
CB50	5.63	5.71 $\pm$ 0.07
CB52	5.84	5.82 $\pm$ 0.07
CB55	6.11	6.01 $\pm$ 0.07
CB56	6.11	6.05 $\pm$ 0.08
CB66	6.20	6.05 $\pm$ 0.07
CB78	6.35	6.07 $\pm$ 0.06
CB85	6.30	6.26 $\pm$ 0.15
CB87	6.29	6.36 $\pm$ 0.09
CB97	6.29	6.22 $\pm$ 0.08
CB99	6.39	6.39 $\pm$ 0.06
CB101	6.38	6.29 $\pm$ 0.07
CB104	5.81	6.18 $\pm$ 0.08
CB105	6.65	6.44 $\pm$ 0.09
CB110	6.48	6.32 $\pm$ 0.09
CB118	6.74	6.44 $\pm$ 0.07
CB128	6.74	6.78 $\pm$ 0.08
CB137	6.83	6.83 $\pm$ 0.07
CB138	6.83	6.78 $\pm$ 0.08
CB141	6.82	6.71 $\pm$ 0.09
CB145	6.25	6.66 $\pm$ 0.08
CB149	6.67	6.65 $\pm$ 0.08
CB151	6.64	6.59 $\pm$ 0.09
CB153	6.92	6.73 $\pm$ 0.09
CB155	6.41	6.8 $\pm$ 0.09
CB156	7.18	6.74 $\pm$ 0.11
CB170	7.27	7.11 $\pm$ 0.16
CB180	7.36	7 $\pm$ 0.17
CB187	7.17	6.89 $\pm$ 0.16
CB204	7.30	7.6 $\pm$ 0.35

<sup>a</sup> Based on Hawker and Connell (1988)

<sup>b</sup> From Smedes et al. (2009)

**Table B-6. Alternative  $K_{PDMS}$  values for selected PAHs. Values reported are log mean  $\pm$  log standard error.**

Target Contaminant	Log $K_{ow}$ <sup>a</sup>	Log $K_{PDMS}$ <sup>b</sup>	Log $K_{PDMS}$ <sup>c</sup>
Naphthalene	3.41	3.03 $\pm$ 0.06	3.23 $\pm$ 0.08
Acenaphthylene	3.71	3.26 $\pm$ 0.06	
Acenaphthene	4.06	3.62 $\pm$ 0.05	
Fluorene	4.20	3.78 $\pm$ 0.04	3.71 $\pm$ 0.04
Phenanthrene	4.74	4.11 $\pm$ 0.04	3.86 $\pm$ 0.05
Anthracene	4.69	4.21 $\pm$ 0.03	4.02 $\pm$ 0.04
Fluoranthene	5.29	4.62 $\pm$ 0.04	4.39 $\pm$ 0.11
Pyrene	5.25	4.69 $\pm$ 0.06	4.41 $\pm$ 0.08
Chrysene	5.90	5.26 $\pm$ 0.04	4.73 $\pm$ 0.17
Benz[a]anthracene	5.85	5.34 $\pm$ 0.08	4.79 $\pm$ 0.11
Benz[a]pyrene	6.54	5.71 $\pm$ 0.05	4.90 $\pm$ 0.16
Benz[e]pyrene			5.09 $\pm$ 0.10
Benz[b]fluoranthene	6.58		5.15 $\pm$ 0.16
Benz[k]fluoranthene	6.50	5.75 $\pm$ 0.04	5.15 $\pm$ 0.17
Benzo[ghi]perylene	7.04	6.03 $\pm$ 0.13	5.05 $\pm$ 0.11
Indeno[1,2,3-cd]pyrene	7.09	6.06 $\pm$ 0.18	5.17 $\pm$ 0.10
Dibenz[a,h]anthracene	7.39	6.24 $\pm$ 0.14	

<sup>a</sup> Based on SPARC program (<http://archemcalc.com/sparc-web/calc>) in June 2014

<sup>b</sup> From Smedes et al. (2009) using the Altel Sil sheet form of PDMS

<sup>c</sup> From Cornelissen et al. (2008b)

### B.2.2 Dioxins and Furans

**Table B-7. Log  $K_{PDMS}$  values for selected dioxins and furans reported by Cornelissen et al. (2008b, c, 2010). Log  $K_{OW}$  values are based on Sacan et al. (2005).**

Target Contaminant	Log $K_{OW}^a$	Log $K_{PDMS}$
2,3,7,8-TCDF	6.41	5.84
1,2,3,7,8-PCDF	6.74	5.95
2,3,4,7,8-PCDF	6.80	5.97
1,2,3,4,7,8-HCDF	7.46	6.05
1,2,3,6,7,8-HCDF	7.56	6.06
1,2,3,7,8,9-HCDF	7.44	6.10
2,3,4,6,7,8-HCDF	7.43	6.08
1,2,3,4,6,7,8-HCDF	7.81	6.15
1,2,3,4,7,8,9-HCDF	7.92	6.20
OCDF	8.43	6.27
2,3,7,8-TCDD	7.05	5.94
1,2,3,7,8-PCDD	7.06	6.05
1,2,3,4,7,8-HCDD	7.93	6.14
1,2,3,6,7,8-HCDD	7.93	6.15
1,2,3,7,8,9-HCDD	7.91	6.13
1,2,3,4,6,7,8-HCDD	8.42	6.23
OCDD	8.85	6.30

### B.3 Low Density Polyethylene

For LDPE,  $K_{LDPE}$  values have been measured by Adams et al. (2007) for nine PAHs, six PAHs, and a dioxin. Fernandez et al. (2009b) added seven more PAH values and 14 additional CB congeners. Perron et al. (2009, 2013a,b) measured coefficients for 26 CBs, 18 PAHs, seven PBDEs, triclosan, methyl triclosan and endosulfan. Smedes et al. (2009) assessed hexachlorobenzene, 41 CBs (Smedes et al. 2009), and 26 PAHs. Hale et al. (2010) added 14 chlorinated pesticides, as well as seven DDTs, and Bao et al. (2011) measured values for 11 PBDE congeners.

As the amount of available data increases, various investigators developed approaches for estimating  $K_{LDPE}$  values for new contaminants. For example, on the basis of a limited data set, Adams et al. (2007) developed the following

correlation of  $K_{LDPE}$  with  $K_{OW}$  (Adams et al. 2007):

$$\text{PAHs: } \log K_{LDPE} = 1.2 \times \log K_{OW} - 0.97 \quad (r^2 = 0.95, n = 8) \quad [\text{B-1}]$$

$$\text{PCBs: } \log K_{LDPE} = 1.8 \times \log K_{OW} - 4.9 \quad (r^2 = 0.97, n = 5) \quad [\text{B-2}]$$

Other correlations developed using expanded data sets are similar. For example, Lohmann (2012) found the following correlations:

$$\text{PAHs: } \log K_{LDPE} = 1.22 (\pm 0.046) \log K_{OW} - 1.22 (\pm 0.24) \quad (r^2 = 0.92, SE = 0.27, n = 65) \quad [\text{B-3}]$$

$$\text{PCBs: } \log K_{LDPE} = 1.14 (\pm 0.041) \log K_{OW} - 1.14 (\pm 0.26) \quad (r^2 = 0.91, SE = 0.24, n = 79) \quad [\text{B-4}]$$



# Appendix C: Effects of Temperature and Salinity on Polymer-Water Partition Coefficients

Passive samplers may find use in diverse environments and at different times of year, so one may expect that the data will reflect polymer-water partitioning at temperatures between 0 and 30°C and at salinities varying from 0‰ to 35‰. Hence, one may need to adjust  $K_{PS}$  values to reflect site conditions when the passive sampling is performed.

This discussion is focused primarily on low density polyethylene, although the experimental data for LDPE are limited it is more extensive than the other polymers. For example, Reible and Lotufo (2012) and Reible et al. (2012) reported for two PDMS SPME fibers (i.e., Fiberguide 230/210 and Polymicro Technologies Inc. 170/110) that temperatures ranging from 4 to 25°C had little effect on  $K_{PDMS}$  values. Recently, Jonker et al. (2015) investigated the effects of temperature (4 to 30 °C) and salinity (0 to 36 ‰) on PDMS film (Altweb AlteSil 500 µm thick) partition coefficients. They found significant effects caused by temperature and salinity resulting in reductions in  $C_{free}$  for several PCBs and PAHs, on average, by a factor of 1.6. The effect was most significant for higher  $K_{OW}$  chemicals. Jonker et al. (2015) provide an equation for adjusting the PDMS partition coefficient to account for the effects of temperature and salinity.

For LDPE, work has been performed to quantify the effects of temperature on  $K_{LDPE}$  values. First, the data indicate that temperature affects  $K_{LDPE}$  chiefly through the target contaminant's excess enthalpy of solution in water, since the excess enthalpy of solution of

hydrophobic compounds in hydrophobic media is generally small (Schwarzenbach et al. 2003). Consequently, the temperature effect can be estimated using:

$$K_{LDPE}(T) = K_{LDPE}(T_{ref}) * \exp [(\Delta H^E/R)(1/T - 1/T_{ref})] \quad [C-1]$$

where:  $K_{LDPE}(T)$  is the polyethylene-water partition coefficient at temperature,  $T$ ,  $K_{LDPE}(T_{ref})$  is the polyethylene-water partition coefficient at some reference temperature (e.g., 25°C),  $\Delta H^E$  is the excess enthalpy of solution for the target compound dissolved in water,  $R$  is the gas constant (8.31 J/mol K),  $T$  is the environmental temperature of interest (in K), and  $T_{ref}$  is the (laboratory) reference temperature at which the  $K_{LDPE}$  has been measured.

In tests of this approach, Adams et al. (2007) found that the temperature dependencies of  $K_{LDPE}$  values for phenanthrene, pyrene, and 2, 2', 5, 5'-tetrachlorobiphenyl (CB52) were consistent with the use of reported  $\Delta H^E$  values (Haftka et al. 2010; Shiu and Ma 2000). For example, using an excess enthalpy of aqueous solution for 2,2',5,5'-tetrachlorobiphenyl of +16 kJ/mol, one estimates that the reported  $K_{LDPE}$  (23°C) of log 5.4 (Hafka et al. 2010, Shiu and Ma 2000) should be increased by a factor of 1.6 for the case of a freshwater lake at 4°C to  $K_{LDPE}$  (4°C) of log 5.6. The measured value was log 5.5 (Adams et al. 2007).

In order to treat the effects of dissolved salts (i.e., seawater), the data also indicate that

one can use the target contaminant's Setchenow constant:

$$K_{LDPE,salt} = K_{LDPE} * 10^{K_s * [salt]} \quad [C-2]$$

where,  $K_s$  is the Setschenow constant (1/M), and [salt] is the salt concentration (M).

For example, assuming that  $K_s$  is  $0.28 \text{ M}^{-1}$  for phenanthrene and a measured  $K_{LDPE}$  of log 4.3 for this PAH, for an 0.5 M NaCl water solution (comparable to full-strength seawater), one finds that the  $K_{LDPE,salt}$  is expected to be 1.07 times greater than  $K_{LDPE}$  for phenanthrene. Experimental measurements confirmed this expectation (Adams et al. 2007). Using this approach, for the case of full-strength seawater, the dissolved salt would cause a small increase in the  $K_{LDPE}$  (phenanthrene) of about 40% to log 4.4.

# Appendix D: Diffusion Coefficients (D) for Metals used in DGTs

**Table D-1. Diffusion coefficients (D) for 11 metals in DGT diffusive gels in relation to temperature (T). Values are valid for temperatures from 1 to 35°C. Units for D and T are cm<sup>2</sup>/s and degrees C, respectively.**

Element	Equation
Ag	$D = (0.0027 \cdot T^2 + 0.2425 \cdot T + 6.3370) \cdot 10^{-6}$
Al	$D = (0.0009 \cdot T^2 + 0.0816 \cdot T + 2.1362) \cdot 10^{-6}$
Cd	$D = (0.0012 \cdot T^2 + 0.1046 \cdot T + 2.7376) \cdot 10^{-6}$
Co	$D = (0.0012 \cdot T^2 + 0.1017 \cdot T + 2.6709) \cdot 10^{-6}$
Cr	$D = (0.0010 \cdot T^2 + 0.0863 \cdot T + 2.2708) \cdot 10^{-6}$
Cu	$D = (0.0012 \cdot T^2 + 0.1067 \cdot T + 2.8002) \cdot 10^{-6}$
Fe	$D = (0.0012 \cdot T^2 + 0.1052 \cdot T + 2.7436) \cdot 10^{-6}$
Mn	$D = (0.0011 \cdot T^2 + 0.1005 \cdot T + 2.6270) \cdot 10^{-6}$
Ni	$D = (0.0011 \cdot T^2 + 0.0990 \cdot T + 2.5946) \cdot 10^{-6}$
Pb	$D = (0.0016 \cdot T^2 + 0.1377 \cdot T + 3.6107) \cdot 10^{-6}$
Zn	$D = (0.0012 \cdot T^2 + 0.1045 \cdot T + 2.7296) \cdot 10^{-6}$

# Appendix E: Example Quality Guidelines for Hydrophobic Organic Contaminant Analysis

**Table E-1. Example quality guidelines for hydrophobic organic contaminant analysis from the Department of Defense (DoD) Quality Management System (QMS) Version 5.0.**

QC Check	Minimum Frequency	Acceptance Criteria	Corrective Action	Flagging Criteria	Comments
Breakdown check (Endrin/DDT Method 8081 only)	Before sample analysis and at the beginning of each 12-hour shift.	Degradation of DDT and Endrin must each be $\leq 15\%$ .	Correct problem, then repeat breakdown checks.	Flagging is not appropriate.	No samples shall be run until degradation of DDT and Endrin is each $\leq 15\%$ .
Initial Calibration (ICAL) for all analytes (including surrogates)	At instrument set-up and after ICV or CCV failure, prior to sample analysis.	ICAL must meet one of the three options below:  Option 1: RSD for each analyte $\leq 20\%$  Option 2: linear least squares regression for each analyte: $r^2 \geq 0.9$  Option 3: non-linear least squares regression (quadratic) for each analyte: $r^2 \geq 0.99$ .	Correct problem then repeat ICAL.	Flagging is not appropriate.	Minimum 5 levels for linear and 6 levels for quadratic. Quantitation for multicomponent analytes such as chlordane toxaphene, and Aroclors must be performed using a 5-point calibration. Results may not be quantitated using a single point. No samples shall be analyzed until ICAL has passed.

QC Check	Minimum Frequency	Acceptance Criteria	Corrective Action	Flagging Criteria	Comments
Retention Time window position establishment	Once per ICAL and at the beginning of the analytical sequence.	Position shall be set using the midpoint standard of the ICAL curve when ICAL is performed. On days when ICAL is not performed, the initial CCV is used.	NA.	NA.	Calculated for each analyte and surrogate.
Retention Time (RT) window width	At method set-up and after major maintenance (e.g., column change).	RT width is $\pm 3$ times standard deviation for each analyte RT from the 72-hour study.	NA.	NA.	Calculated for each analyte and surrogate.
Initial Calibration Verification (ICV)	Once after each ICAL, analysis of a second source standard prior to sample analysis.	All reported analytes within established RT windows.  All reported analytes within $\pm 20\%$ of true value.	Correct problem, rerun ICV. If that fails, repeat ICAL.	Flagging is not appropriate.	No samples shall be analyzed until calibration has been verified with a second source.

QC Check	Minimum Frequency	Acceptance Criteria	Corrective Action	Flagging Criteria	Comments
Continuing Calibration Verification (CCV)	Before sample analysis, after every 10 field samples, and at the end of the analysis sequence with the exception of CCVs for Pesticides multi-component analytes (i.e. Toxaphene, Chlordane), which are only required before sample analysis.	<p>All reported analytes and surrogates within established RT windows.</p> <p>All reported analytes and surrogates within <math>\pm 20\%</math> of true value.</p>	<p>Recalibrate, and reanalyze all affected samples since the last acceptable CCV; or</p> <p>Immediately analyze two additional consecutive CCVs. If both pass, samples may be reported without reanalysis. If either fails, take corrective action(s) and re-calibrate; then reanalyze all affected samples since the last acceptable CCV.</p>	<p>If reanalysis cannot be performed, data must be qualified and explained in the case narrative.</p> <p>Apply Q-flag to all results for the specific analyte(s) in all samples since the last acceptable calibration verification.</p>	<p>Results may not be reported without a valid CCV. Flagging is only appropriate in cases where the samples cannot be reanalyzed.</p>
Method Blank (MB)	One per preparatory batch.	No analytes detected $> 1/2$ LOQ or $> 1/10$ the amount measured in any sample or $1/10$ the regulatory limit, whichever is greater.	Correct problem. If required, reprep and reanalyze MB and all samples processed with the contaminated blank.	<p>If reanalysis cannot be performed, data must be qualified and explained in the case narrative.</p> <p>Apply B-flag to all results for the specific analyte(s) in all samples in the associated preparatory batch.</p>	<p>Results may not be reported without a valid method blank. Flagging is only appropriate in cases where the samples cannot be reanalyzed.</p>

QC Check	Minimum Frequency	Acceptance Criteria	Corrective Action	Flagging Criteria	Comments
Laboratory Control Sample (LCS)	One per preparatory batch.	A laboratory must use the QSM Appendix C Limits for batch control if project limits are not specified. If the analyte(s) are not listed, use in-house LCS limits if project limits are not specified.	Correct problem, then reprep and reanalyze the LCS and all samples in the associated preparatory batch for failed analytes, if sufficient sample material is available.	If reanalysis cannot be performed, data must be qualified and explained in the case narrative. Apply Q-flag to specific analyte(s) in all samples in the associated preparatory batch.	Results may not be reported without a valid LCS. Flagging is only appropriate in cases where the samples cannot be reanalyzed.
Matrix Spike (MS)	One per preparatory batch.	A laboratory must use the QSM Appendix C Limits for batch control if project limits are not specified. If the analyte(s) are not listed, use in-house LCS limits if project limits are not specified.	Examine the project- specific requirements. Contact the client as to additional measures to be taken.	For the specific analyte(s) in the parent sample, apply J-flag if acceptance criteria are not met and explain in the case narrative.	If MS results are outside the limits, the data shall be evaluated to determine the source(s) of difference (i.e., matrix effect or analytical error).
Matrix Spike Duplicate (MSD) or Matrix Duplicate (MD)	One per preparatory batch.	A laboratory must use the QSM Appendix C Limits for batch control if project limits are not specified. If the analyte(s) are not listed, use in-house LCS limits if project limits are not specified. RPD $\leq 30\%$ (between MS and MSD or sample and MD).	Examine the project-specific requirements. Contact the client as to additional measures to be taken.	For the specific analyte(s) in the parent sample, apply J-flag if acceptance criteria are not met and explain in the case narrative.	The data shall be evaluated to determine the source of difference.

QC Check	Minimum Frequency	Acceptance Criteria	Corrective Action	Flagging Criteria	Comments
Surrogate Spike	All field and QC samples.	QC acceptance criteria specified by the project, if available; otherwise use QSM Appendix C limits or in-house LCS limits if analyte(s) are not listed.	Correct problem, then reprep and reanalyze all failed samples for all surrogates in the associated preparatory batch, if sufficient sample material is available. If obvious chromatographic interference with surrogate is present, reanalysis may not be necessary.	Apply Q-flag to all associated analytes if acceptance criteria are not met and explain in the case narrative.	Alternative surrogates are recommended when there is obvious chromatographic interference.
Confirmation of positive results (second column)	All positive results must be confirmed (except for single column methods such as TPH by Method 8015 where confirmation is not an option or requirement).	Calibration and QC criteria for second column are the same as for initial or primary column analysis. Results between primary and secondary column RPD $\leq 40\%$ .	NA.	Apply J-flag if RPD $>40\%$ . Discuss in the case narrative.	Use project-specific reporting requirements if available; otherwise, use method requirements if available; otherwise report the result from the primary column.



Table E-2. Organic analysis by high-performance liquid chromatography (HPLC)

QC Check	Minimum Frequency	Acceptance Criteria	Corrective Action	Flagging Criteria	Comments
Initial Calibration (ICAL) for all analytes (including surrogates)	At instrument set-up and after ICV or CCV failure, prior to sample analysis.	ICAL must meet one of the three options below:  Option 1: RSD for each analyte $\leq 20\%$  Option 2: linear least squares regression for each analyte: $r^2 \geq 0.99$  Option 3: non-linear least squares regression (quadratic) for each analyte: $r^2 \geq 0.99$ .	Correct problem, then repeat ICAL.	Flagging is not appropriate.	Minimum 5 levels for linear and 6 levels for quadratic. No samples shall be analyzed until ICAL has passed.
Retention Time window position establishment	Once per ICAL and at the beginning of the analytical sequence.	Position shall be set using the midpoint standard of the ICAL curve when ICAL is performed. On days when ICAL is not performed, the initial CCV is used.	NA.	NA.	Calculated for each analyte and surrogate.
Retention Time (RT) window width	At method set-up and after major maintenance (e.g., column change).	RT width is $\pm 3$ times standard deviation for each analyte RT from the 72-hour study.	NA.	NA.	Calculated for each analyte and surrogate.
Initial Calibration Verification (ICV)	Once after each ICAL, analysis of a second source standard prior to sample analysis.	All reported analytes within established RT windows.  All reported analytes within $\pm 15\%$ of true value.	Correct problem, rerun ICV. If that fails, repeat ICAL.	Flagging is not appropriate.	No samples shall be analyzed until calibration has been verified with a second source.

QC Check	Minimum Frequency	Acceptance Criteria	Corrective Action	Flagging Criteria	Comments
Continuing Calibration Verification (CCV)	Before sample analysis, after every 10 field samples, and at the end of the analysis sequence.	<p>All reported analytes and surrogates within established RT windows.</p> <p>All reported analytes and surrogates within <math>\pm 15\%</math> true value.</p>	<p>Recalibrate, and reanalyze all affected samples since the last acceptable CCV;</p> <p>or</p> <p>Immediately analyze two additional consecutive CCVs. If both pass, samples may be reported without reanalysis. If either fails, take corrective action(s) and re-calibrate; then reanalyze all affected samples since the last acceptable CCV.</p>	<p>If reanalysis cannot be performed, data must be qualified and explained in the case narrative. Apply Q-flag to all results for the specific analyte(s) in all samples since the last acceptable calibration verification.</p>	<p>Results may not be reported without a valid CCV. Flagging is only appropriate in cases where the samples cannot be reanalyzed.</p> <p>Retention time windows are updated per the method.</p>
Method Blank (MB)	One per preparatory batch.	No analytes detected $>1/2$ LOQ or $>1/10$ the amount measured in any sample or $1/10$ the regulatory limit, whichever is greater.	Correct problem. If required, reprep and reanalyze MB and all samples processed with the contaminated blank.	If reanalysis cannot be performed, data must be qualified and explained in the case narrative. Apply B-flag to all results for the specific analyte(s) in all samples in the associated preparatory batch.	<p>Results may not be reported without a valid method blank.</p> <p>Flagging is only appropriate in cases where the samples cannot be reanalyzed.</p>

QC Check	Minimum Frequency	Acceptance Criteria	Corrective Action	Flagging Criteria	Comments
Laboratory Control Sample (LCS)	One per preparatory batch.	<p>A laboratory must use the QSM Appendix C Limits for batch control if project limits are not specified.</p> <p>If the analyte(s) are not listed, use in-house LCS limits if project limits are not specified.</p>	<p>Correct problem, then reprep and reanalyze the LCS and all samples in the associated preparatory batch for the failed reported analytes, if sufficient sample material is available.</p>	<p>If reanalysis cannot be performed, data must be qualified and explained in the case narrative.</p> <p>Apply Q-flag to specific analyte(s) in all samples in the associated preparatory batch.</p>	<p>Results may not be reported without a valid LCS. Flagging is only appropriate in cases where the samples cannot be reanalyzed.</p>
Matrix Spike (MS)	One per preparatory batch.	<p>A laboratory must use the QSM Appendix C Limits for batch control if project limits are not specified.</p> <p>If the analyte(s) are not listed, use in-house LCS limits if project limits are not specified.</p>	<p>Examine the project-specific requirements. Contact the client as to additional measures to be taken.</p>	<p>For the specific analyte(s) in the parent sample, apply J-flag if acceptance criteria are not met and explain in the case narrative.</p>	<p>If MS results are outside the limits, the data shall be evaluated to determine the source(s) of difference (i.e., matrix effect or analytical error).</p>
Matrix Spike Duplicate (MSD) or Matrix Duplicate (MD)	One per preparatory batch.	<p>A laboratory must use the QSM Appendix C Limits for batch control if project limits are not specified.</p> <p>If the analyte(s) are not listed, use in-house LCS limits if project limits are not specified.</p> <p>RPD <math>\leq</math> 30% (between MS and MSD or sample and MD).</p>	<p>Examine the project-specific requirements. Contact the client as to additional measures to be taken.</p>	<p>For the specific analyte(s) in the parent sample, apply J-flag if acceptance criteria are not met and explain in the case narrative.</p>	<p>The data shall be evaluated to determine the source of difference.</p>

QC Check	Minimum Frequency	Acceptance Criteria	Corrective Action	Flagging Criteria	Comments
Surrogate Spike	All field and QC samples.	QC acceptance criteria specified by the project, if available; otherwise use QSM Appendix C limits or in-house LCS limits if analyte(s) are not listed.	Correct problem, then reprep and reanalyze all failed samples for all surrogates in the associated preparatory batch, if sufficient sample material is available. If obvious chromatographic interference with surrogate is present, reanalysis may not be necessary.	Apply Q-flag to all associated analytes if acceptance criteria are not met and explain in the case narrative.	Alternative surrogates are recommended when there is obvious chromatographic interference.
Confirmation of positive results (second column)	All positive results must be confirmed.	Calibration and QC criteria for second column are the same as for initial or primary column analysis.  Results between primary and secondary column/detector RPD $\leq$ 40%.	NA.	Apply J-flag if RPD >40%. Discuss in the case narrative.	Spectral match confirmation of a UV detector with a UV diode array detector (or vice versa) is not considered an acceptable confirmation technique. A second column confirmation is required.  Use project-specific reporting requirements if available; otherwise, use method requirements, if available; otherwise, report the result from the primary column.

# Appendix F: Case Studies

This appendix provides a set of six case studies illustrating the use of passive sampling at contaminated sediment sites.

## Case Study 1: Lower Grasse River, New York, USA

### Background

- Target Contaminants:  
Polychlorinated biphenyls (PCBs)
- Passive Sampler:  
Polyoxymethylene (POM)

### Site Narrative

According to Alcoa (2001), the main source of PCBs to the water column in the lower Grasse River in New York (USA) is diffusive flux from the sediment bed. PCBs desorb from the sediment, diffuse through interstitial water, and migrate past the sediment/water interface and into the overlying water. It has been determined that the mass transfer of CBs into the water column is twice as high during the summer months than during the rest of the year (Alcoa 2001).

In 2006, activated carbon (AC) was amended to river sediments over a 2000-m<sup>2</sup> area of the lower Grasse River where total concentrations of PCBs in surficial sediments were 2 to 4 µg/g dry wt. A comprehensive monitoring program was established to track the following changes in bioavailability over time: (1) measurements of AC distributions and (2) bioaccumulation of PCBs by freshwater invertebrates. POM samplers were deployed in field to measure PCB  $C_{\text{free}}$  in surface waters and interstitial waters (Beckingham and Ghosh 2013).

### Project Objectives

- To compare passive sampler measurements to changes in bioavailability measured with sediment invertebrate bioaccumulation tests (Beckingham and Ghosh 2013).

### Deployment and Retrieval of POM Samplers

POM strips obtained from the Norwegian Geotechnical Institute were cut to 55 µm thick, cleaned via Soxhlet extraction with hexane for 12 hours, air-dried in a fume hood, cut down to 0.2-g strips, and stored in a glass jar until deployment. The strips were attached with plastic wire ties to a rope and wire basket (Figure F-1) used for the bioaccumulation tests and positioned in duplicate on the surficial sediment (0 cm, bottom of the basket) and at 7.5, 30, and 60 cm in the water column above the sediment surface. The strips were retrieved after 14 days, rinsed with site water, and stored in glass vials at 4°C. Baseline measurements were taken in 2006, followed by continued monitoring events in 2007, 2008 and 2009. POM was deployed at an untreated background site and at an AC treated site in 2006 and 2007; POM deployments were extended to two additional sites in both areas in 2008 and 2009 (Beckingham and Ghosh 2013).

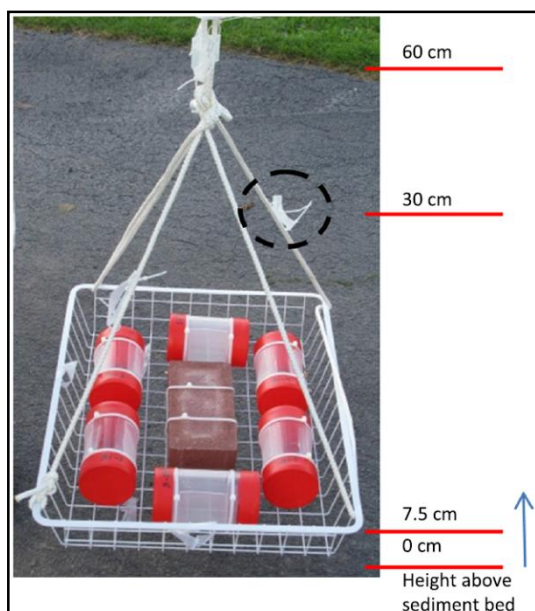

**Figure F-1. Deployment of POM strips in the field. POM strips were wire-tied to the basket and rope (Beckingham and Ghosh 2013).**

### *Analytical Methods*

The following is taken from Beckingham and Ghosh (2013). To process POM for CB analysis, strips were wiped clean and then extracted by agitating in 12 mL glass vials on a horizontal shaker with 10 mL hexane for five days (Cornelissen et al. 2008). Extracts were then spiked with surrogate standards (PCB congeners CB14 and CB65), concentrated to 1 mL, and cleaned by column chromatography. Columns consisted of disposable glass Pasteur pipettes (14.5 cm length  $\times$  6 mm diameter) plugged with glass wool containing  $\sim$ 0.7 g of 3% deactivated silica gel, and the CBs were eluted with 8 mL of hexane. Internal standards were added (CB30 and CB204), and CBs (90 individual and co-eluting congener peaks) were analyzed by gas chromatography with electron capture detection (GC-ECD) following a modified EPA method described in Ghosh et al. (2003). Surrogate

compound recovery was within acceptable criteria of  $100 \pm 30\%$ . However, an additional extraction with hexane:acetone (1:1, vol) of several POM strips found that  $\sim$ 8%–20% of total CBs remained after the initial 5-day hexane extraction. All data herein show results that have not been corrected to compensate for this systematic error. POM in batch tests was extracted with the same method to enable comparison to the field data. Aqueous concentrations were calculated according to Equation 8-1:

$$C_{free} = \frac{C_{POM}}{K_{POM}}$$

where,  $C_{free}$  is the freely dissolved concentration,  $C_{POM}$  is the amount accumulated in the polymer at equilibrium, and  $K_{POM}$  is the polymer-water distribution coefficient.

### *Results*

Results showed that sediments treated with AC behaved as a sink for CBs in the water column (Figure F-2); CB concentrations were lower at the sediment/water interface in treated areas (2007–2009) than in background sites, and lower than concentrations at treated areas in 2006, prior to AC amendment. In general, reduced uptake of PCB  $C_{free}$  homologs di-through penta- in POM passive samplers correlated with reduced uptake in invertebrates (Figure F-3) (Beckingham and Ghosh 2013).

The study ultimately showed that POM passive samplers can be effective tools for monitoring changes in PCB  $C_{free}$ , and that the bioavailability of PCBs is significantly reduced with the addition of AC (Beckingham and Ghosh 2013).

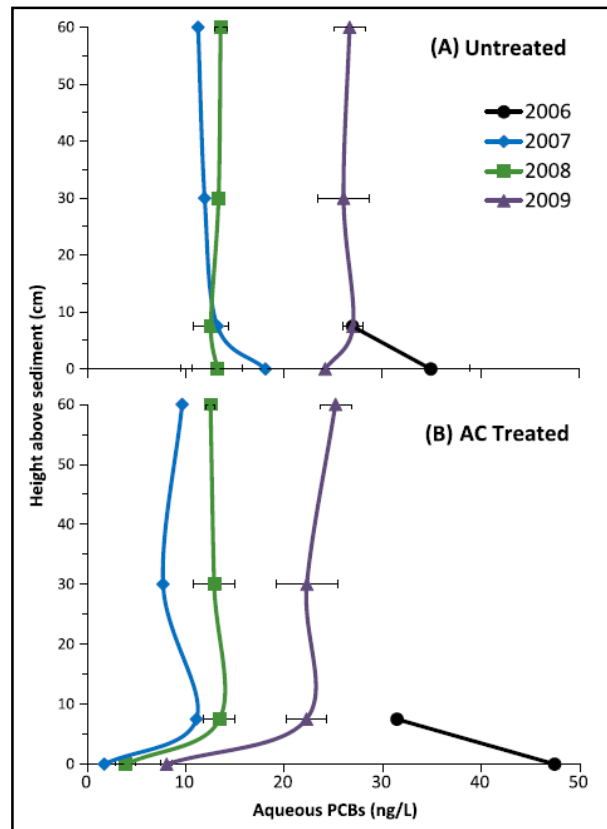

**Figure F-2. Gradient of total PCB  $C_{free}$  from the sediment/water interface into the water column in untreated (A) and AC treated (B) areas (Beckingham and Ghosh 2013).**

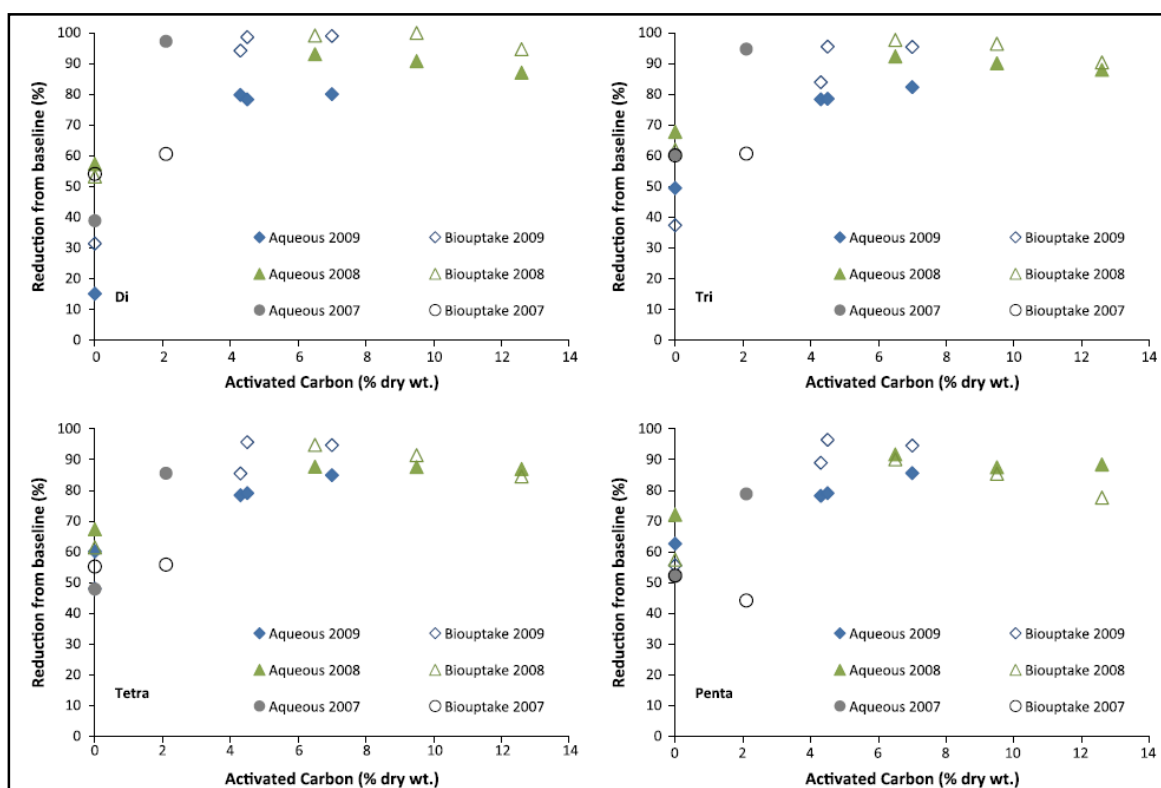

**Figure F-3. Percent reductions over time in aqueous concentrations determined by POM passive sampling at the sediment–water interface and bioaccumulation by freshwater oligochaetes, *L. variegatus*, from field deployments as a function of the applied activated carbon dose by PCB chlorination level (i.e., di, tri, tetra, penta) (Beckingham and Ghosh 2013).**

### Regulatory Use

POM passive samplers can be used to determine concentrations of PCBs that are bioavailable in sediments and overlying water.

### References

Alcoa. 2001. *Comprehensive Characterization of the Lower Grasse River*, vol. 1 – Main Report. Amended April 2001.

Beckingham B, Ghosh U. 2013. Polyoxymethylene passive samplers to monitor changes in bioavailability and flux of CBs after activated carbon amendment to sediment. *Chemosphere* 91:1401–1407.

Cornelissen G, Petterson A, Broman D, Mayer P, Breedveld GD. 2008. Field testing of equilibrium passive samplers to determine freely dissolved native polycyclic aromatic hydrocarbon concentrations. *Environ Toxicol Chem* 27:499–508.

Ghosh U, Zimmerman JR, Luthy RG. 2003. PCB and PAH Speciation among particle types in contaminated harbor sediments and effects on PAH bioavailability. *Environ Sci Technol* 37:2209–2217.



## Case Study 2: Pacific Sound Resources Superfund Site (Marine Sediment Unit), Seattle, Washington,

### *Background*

- Target Contaminants: Polycyclic aromatic hydrocarbons (PAHs), dibenzofuran, and 2-methylnaphthylene
- Passive Sampler: Solid-phase microextraction (SPME)—polydimethylsiloxane (PDMS)-coated fibers

### *Site Narrative*

The Pacific Sound Resources (PSR) Superfund site is located on Elliot Bay in Seattle, Washington (USA). PSR was a wood-treating facility that operated from 1909 to 1994, and the principal contaminants are creosote related including polycyclic aromatic hydrocarbons (PAHs). The site is divided into an upland area unit and a marine sediment unit. The upland area unit is approximately 10 hectares, with light non-aqueous-phase liquids (LNAPLs) contained by a slurry wall and recovery trench. Groundwater wells are positioned outside of the slurry wall to monitor for PAHs in groundwater. The marine unit is 23 hectares. Remedial actions included dredging, placement of a sediment cap, and institutional controls. The subtidal sediments were capped with material from the Lower Duwamish Waterway to variable depths: 2.3 meters (near shore), 1.1 meters (mid-shore), and 0.3 meters at the deepest part of the site.

Creosote-related contaminants remain in the subsurface and extend below the intertidal and subtidal zones as dissolved phase or NAPLs. In addition, low levels of PAHs, dibenzofuran and 2-methyl-naphthylene have been detected in groundwater wells outside the upland containment wall. Monitoring of cap bulk surface sediments had not detected PAHs; a

data gap was identified suggesting to the potential for dissolved PAHs and NAPLs to be released at water depths that would be logistically difficult to sample by conventional means (e.g., to 24 meters below mean low water). U.S. EPA Region 10 elected to deploy vertical-profiling SPME passive sampling to determine whether dissolved phase contaminants currently affect surface water quality at the site.

This site is an example where U.S. EPA scientific divers deployed and recovered the passive samplers insuring proper sampler placement and data quality and integrity.

### *Project Objectives*

This investigation has two objectives: (1) Collect and analyze interstitial water concentrations with passive samplers in areas with the potential for contaminated groundwater discharge to surface water and compare the results to surface-water quality criteria and (2) Collect and analyze surface sediment grab samples co-located with interstitial water samples, to evaluate sediment quality, determine compliance with sediment standards, and assess equilibrium partitioning between interstitial water and sediment-associated phases. If the theoretical interstitial water/sediment equilibrium is greatly exceeded, this could indicate advective discharge of contaminated groundwater.

### *Deployment and Retrieval of Passive Samplers*

Details of the preparation, deployment, retrieval, and analyses are found in the work plan for the site (EPA/USACE 2010). SPMEs were housed in a modified push point sampler assembly developed at the University of Texas (Figure F-4). The assembly consists of piezometers that have been modified to serve as a shielded sheath for SPME-PDMS coated glass fibers. Details of the sampler and SPME fiber preparation procedures can be found in Reible

and Lotufo (2012a). Before loading the SPME fibers, the sampling devices were cleaned and decontaminated.



**Figure F-4. SPME sampler in the laboratory (upper) and insertion into intertidal sediment in the field (lower) (figures from Reible and Lu (2011)).**

A total of 24 locations were sampled at PSR. Sample locations were down gradient from upland groundwater monitoring wells that contain NAPL or elevated concentrations of PAHs, or down gradient of known NAPL-affected areas beyond the slurry wall containment area. The SPME samplers were designed to sample interstitial water up to a depth of one meter below the cap/water interface in areas that were capped with 0.3 to 0.6 meters of material. Two additional samplers

were deployed to measure surface concentrations in the water column. The surface-water SPMEs were attached to the top of the modified push point sampler inserted into the sediment, with the additional SPME fiber suspended approximately 0.3 m above the sediment/water interface. An additional regional background SPME surface water sample was collected from an area with no known nearby sources of PAHs. For each location, surface sediment samples were also diver-collected following SPME insertion at a radial distance of 0.3 m from the SPME insertion location. A 0.3 m clearance was provided so that the sediment surface grab sampling did not affect the SPMEs following insertion.

All fibers were equilibrated *in situ* for seven days before retrieval. This time was chosen as a balance between using short times to minimize sample disturbance or the occurrence of vandalism and the time required to achieve equilibration. To account for non-equilibrium conditions, two types of fibers were deployed: (1) relatively thicker 1000/1071 fibers at all stations, and (2) simultaneously deployed smaller-diameter, (210/230), fast-uptake fibers. During retrieval, the SPME fibers were withdrawn from the sediment by the diver (Figure F-5) and processed immediately, on the boat, to reduce evaporative or other losses from the fiber.

The insertion tools were dismantled, and the fibers were removed from the sampler and wiped with damp tissue to remove sediment particles. The fibers were then cut into intervals for analysis as follows:

- Target depth 0–10 cm; sampled intervals at 3–5 and 5–7 cm
- Target depth 10–20 cm; sampled intervals at 13–15 and 15–17 cm
- Target depth 51–61 cm; sampled intervals at 53–55 and 55–57 cm

- Target depth 69–76 cm; sampled intervals at 70–72 and 72–74 cm



**Figure F-5. U.S. EPA scientific diver Brent Richmond collects a surface grab sample co-located with a SPME passive sampler at the PSR site (image taken by Sean Sheldrake).**

The bottom segment initially targeted the 0.8 to 1.0 m interval, but recovery of samples from this deeper interval was deemed to be inconsistent due to the silicone adhesive used to place the fibers within the insertion tool. Initial samples were collected from the 70- to 72-cm and 72- to 74-cm intervals, and subsequent samples were collected from the same intervals.

The fibers were added in the field to 2mL amber auto-sampling vials prefilled with 220  $\mu$ L of acetonitrile (acetonitrile is also the HPLC carrier phase) and a surrogate (internal) standard (benzo[a]fluorene). Sectioned samples were shipped overnight to the University of Texas at 4°C and were subsequently stored in a freezer at 0°C until analysis.

### **Analytical Methods**

The sixteen priority pollutant PAHs, dibenzofuran (DBF), and 2-methylnaphthalene (2-MNP) were analyzed by EPA Method 8310 (SW-846 3rd edition, 1986) with a Waters 2690 HPLC equipped with a fluorescence detector. Acenaphthylene is not detectable by the fluorescence detector and benzo[g,h,i]perylene and indeno[1,2,3-hcd]pyrene appeared to co-elute, as demonstrated in a previous calibration study (Reible and Lotufo 2012c).

The resulting SPME concentrations were converted to corresponding interstitial water  $C_{\text{free}}$  using Equation 8-1 (for PDMS) adjusted for non-equilibrium conditions.

### **Results**

Low-molecular-weight compounds, PAHs, naphthalene, dibenzofuran, 2-methylnaphthalene, fluorene, acenaphthylene, and phenanthrene exhibited very low concentrations in almost all samples. These were below compound-specific practical quantification limits and were not significantly different from deployment and retrieval blanks and surface-water samples. The concentrations of medium- and high-molecular-weight compounds in most samples were higher than the blanks, although still below the water quality criteria water-only effect concentration. The higher molecular weight compounds dibenz[a,h]anthracene and the co-eluting benzo[ghi]perylene + indeno[1,2,3-cd]pyrene suite were not detected in any sample. No clear vertical concentration gradients were observed in the cap.

**Regulatory Use**

EPA Region 10 concluded that, given that the interstitial water concentrations of PAHs were low and not clearly linked to site contaminants or migration from upland sites, the PSR sediment cap appeared to be functioning as designed and is effectively containing site contaminants.

**Site Contact**

Ravi Sanga, USEPA Region 10.  
John Wakeman, USACE Seattle District

**References**

EPA Method 8310 (SW-846) 3rd edition, 1986.

Reible D, Lu X. 2011. *Solid-Phase Microextraction Field Deployment and Analysis Pacific Sound Resources*. Report prepared for the USACE Seattle District and US EPA Region 10. University of Texas. February 14, 2011.

Reible D, Lotufo G. 2012a. *Demonstration and Evaluation of Solid Phase Microextraction for the Assessment Of Bioavailability and Contaminant Mobility*. ESTCP Project ER-200624. Available from:  
<http://www.serdp.org/content/download/15533/176851/file/ER-200624-Guidance%20Doc.pdf>.

Reible D, Lotufo G. 2012b. *Demonstration and Evaluation of Solid Phase Microextraction for the Assessment of Bioavailability and Contaminant Mobility*. Final Report. ESTCP Project ER-200624.

Reible D, Lotufo G. 2012c. *Final Report. Demonstration and Evaluation of Solid Phase Microextraction for the Assessment of Bioavailability and Contaminant Mobility*. ESTCP Project ER-200624. Available on the web at:  
<http://www.serdp.org/content/download/5137/72968/file/ER-0624-Lab-Rep.pdf>.

USEPA/USACE. 2010. *Solid Phase Microextraction Field Deployment and Analysis Work Plan Pacific Sound Resources Superfund Site*. Seattle, WA. U.S. Environmental Protection Agency Region 10, and the U.S. Army Corps of Engineers Seattle District. September 17, 2010. Available from:  
[http://www.epa.gov/region10/pdf/sites/psr/Field\\_Deployment\\_Work\\_Plan.pdf](http://www.epa.gov/region10/pdf/sites/psr/Field_Deployment_Work_Plan.pdf).

### **Case Study 3: Wyckoff/Eagle Harbor Superfund Site (East Harbor Operable Unit), Bainbridge Island, Washington, USA**

#### ***Background***

- Target Contaminants:  
Creosote-derived polycyclic aromatic hydrocarbons (PAHs)
- Passive Sampler:  
Solid-phase microextraction (SPME) - polydimethylsiloxane (PDMS)-coated fibers

#### ***Site Narrative***

The Wyckoff/Eagle Harbor Superfund Site, East Harbor Operable Unit (EHOU) is located on Bainbridge Island, Washington. The site is a former wood-treating facility that operated from the early 1900s through 1988; pressure treatment of utility poles with creosote and bunker oil began in 1910. Relevant completed remedial actions at the EHOU, to date, include:

- Placement of a subtidal sediment cap, completed in three phases between 1994 and 2002 (Figure F-6);
- Upland source control, completed in February 2001 by installation of a sheet-pile wall around the perimeter of the former process area;
- Construction of an exposure barrier system (EBS), completed in 2008, covering approximately 300 linear meters of West Beach and approximately 5.1 acres (2.06 hectares) from the southern edge of the existing subtidal cap; and
- Monitored natural recovery along the eastern intertidal area

Monitoring of the marine portions of the EHOU was conducted in 2011. The efficacy of the subtidal cap is monitored principally by collecting sediment grab and/or core samples,

chemical analyses, and comparison of the resultant values to site human health remedial action levels and the sediment management standards (HDR et al, 2012). An additional component of the 2011 monitoring was the evaluation of whether PAHs were advecting in interstitial water from the native contaminated sediments up through the cap and into the overlying water. Passive samplers co-located at sediment sampling locations were used to evaluate this potential pathway (Thomas et al. 2012).

#### ***Project Objectives***

- Evaluate whether near-surface cap interstitial water concentrations exceed water quality criteria effect concentrations for PAHs
- Identify vertical profiles in PAH interstitial water concentrations to ascertain whether dissolved phase contaminants are migrating through the subtidal cap
- Compare depth discrete interstitial water PAH concentrations determined by SPMEs with measures made using integrated interstitial water samples collected from bulk sediment measurements.

#### ***Deployment and Retrieval of Passive Samplers***

Details of the preparation, deployment, retrieval and analyses reported here are from the final report for the site (Thomas et al. 2012). SPMEs were housed in a modified push point sampling assembly developed by the University of Texas. The samplers are piezometers that have been modified to serve as a shielded sheath for the SPME-PDMS coated glass fibers. Details of the sampler and SPME fiber preparation procedures are found in Reible and Lotufo (2012).

Given the limited sampling period (7 days), two methods were used to evaluate uptake and estimate equilibrium dissolved concentrations of PAHs. Two distinct SPME fibers were used:

1000/1071- $\mu\text{m}$  fiber (115  $\mu\text{L}$  PDMS/m) and 1000/1060- $\mu\text{m}$  fiber (97.1  $\mu\text{L}$  PDMS/m). Second, deuterated PAHs were impregnated into the 1000/1071- $\mu\text{m}$  fiber as performance reference compounds (PRCs). The four PRCs were fluoranthene-d10, chrysene-d12, benzo[b]fluoranthene-d12, and dibenz[a,h]anthracene-d14.

To adequately evaluate potential interstitial water vertical profiles, cap thickness data were used to select the appropriate sampler length. Of specific interest are stations G-8 where there was only 0.61 m of capping material, and J9 where there was little to no capping material over the NAPL-contaminated sediments. Vertical profiles of PAH concentrations were obtained for depths of 30 to 90 cm from the sediment/water interface based on the relative cap thickness (Figure F-6). There were a total of 17 onsite deployments, and one offsite location to serve as a reference station. Surface water-column measurements were obtained using fibers deployed approximately 30 cm above the sediment/surface-water interface at three locations—two onsite and one offsite—in a nearby harbor located down gradient of the site (Figure F-7).

The SPME samplers were deployed and retrieved by EPA Region 10 divers (Figure F-8). Six of the 90-cm samplers were loaded with 1000/1071- $\mu\text{m}$  fibers spiked with PRCs to assess the fraction of equilibrium attained during the deployment. The deployed samplers and the two field blanks were processed by dismantling the samplers, removing the fibers using a thin metal blade, and wiping with a laboratory tissue dampened with deionized water to remove any particulate matter. The fibers were then sectioned into adjacent 2-cm fiber segments, placed in prefilled vial inserts containing acetonitrile, and shipped on ice back to the University of Texas in Austin.

### *Analytical Method*



The PDMS solvent extracts were transferred from the original vial insert to a new vial insert to avoid interference from the fiber during analysis. The PDMS solvent extracts were analyzed using high-performance liquid chromatography (HPLC) according to EPA Method 8310. Ultraviolet (UV) and fluorescence (FLD) detectors were used to quantify the EPA 16 priority PAHs. Chromatographic separation was conducted using a 1.0 mL/min isocratic flow composed of 3:7 (v:v) water:acetonitrile.

Limitations to this analytical method include: acenaphthylene cannot be analyzed by fluorescence detector, and the method detection limit (MDL) is 20  $\mu\text{g/L}$  with UV, and benzo[g,h,i]perylene and indeno[1,2,3-cd]pyrene coelute and must be reported as a single combined concentration.

The interstitial water  $C_{\text{free}}$  was determined based on the reported HPLC-measured concentration, the volume of solvent used to extract the fiber, the length of fiber sample, specific volume of the fiber, and PAH  $K_{\text{PDMS}}$ . The  $K_{\text{PDMS}}$  were determined by Reible (2010). Equilibrium correction factors were determined based on the PRC loss over the seven day sampling period, and were applied to all sampling locations to determine the absolute interstitial water  $C_{\text{free}}$  at those locations.

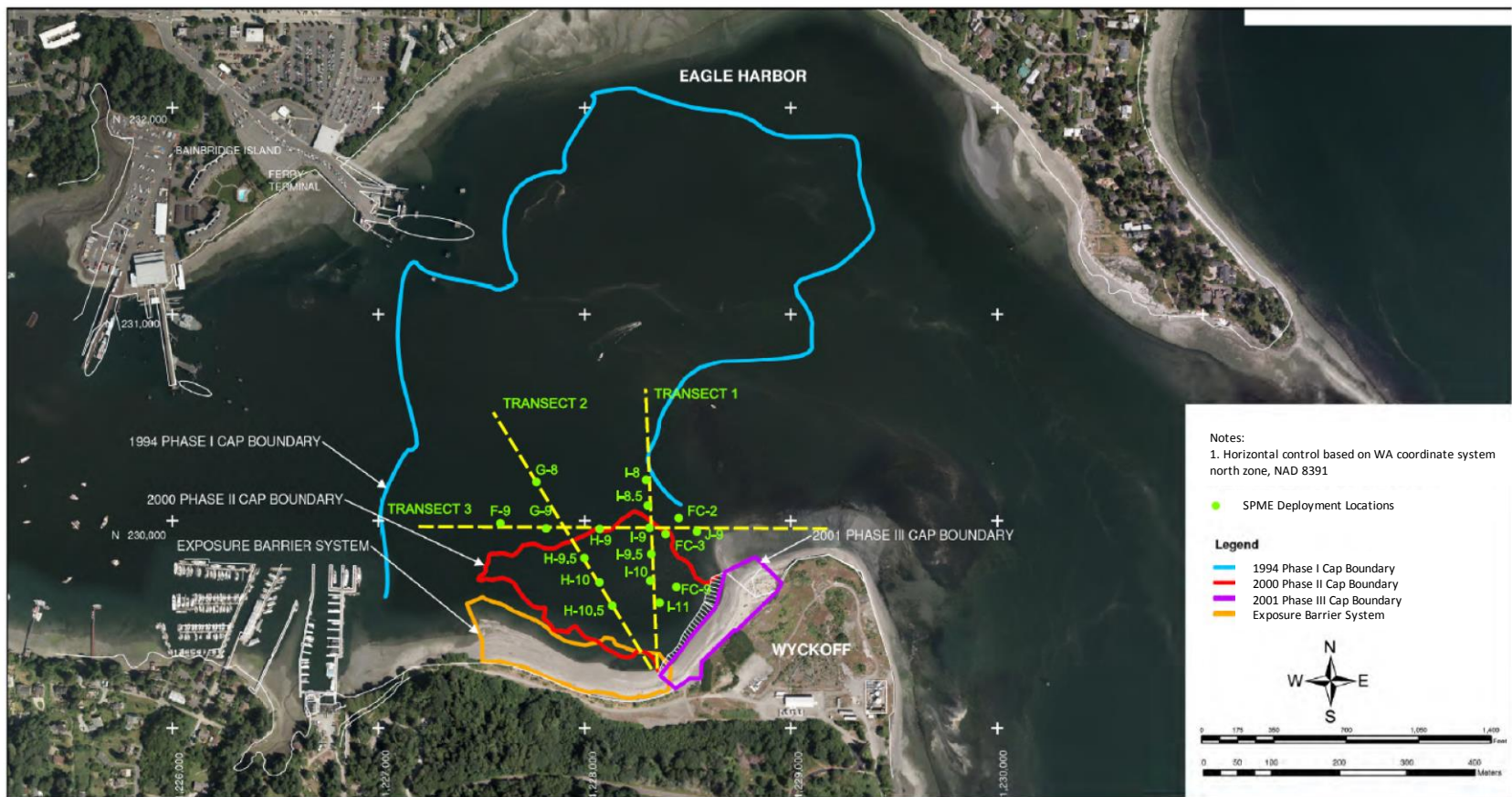
The resultant interstitial water concentrations were compared to EPA's Ambient Water Quality Criteria (AWQC) for PAHs, and to the measures of PAHs made in the overlying surface water. To compare the measured interstitial water concentrations to estimated interstitial water concentrations, the sampled SPME intervals were matched to the bulk sediment PAH and total organic carbon measures from a 2011 report (HDR 2012).



Project Name		Figure Name	
 	2011 OMMP Addendum East Harbor Operable Unit Wyckoff/Eagle Harbor Superfund Site	Locations of Intertidal and Subtidal Sediment Caps and Exposure Barrier System	Figure-2

**Figure F-6. Cap Boundary areas and SPME sampling locations. SPME sampling locations were placed on transects from the shore and were co-located with bulk sediment sampling locations. Two SPMEs were deployed in surface water ~ 0.3 m above the sediment surface between G-8 and H-9.5 (designated sample SW-1) and H-10 and H-10.5 (SW-2). (Base figure from HDR et al. (2012). Sampling location figure from Thomas et al. (2012)).**

## Results

No surface water or near surface interstitial water sample concentrations exceeded AWQC. In the evaluation of contaminant profiles, with one exception, all sampling locations showed no evidence of contaminant migration through the cap material. The exception was J9 where PAHs were detected at a depth of 33 cm below the sediment surface. The concentration of benzo(a)pyrene exceeded the AWQC. Location G-8 showed evidence of low levels of contamination but the profile data suggested that off-site surface sources were more likely responsible for the PAHs measured.

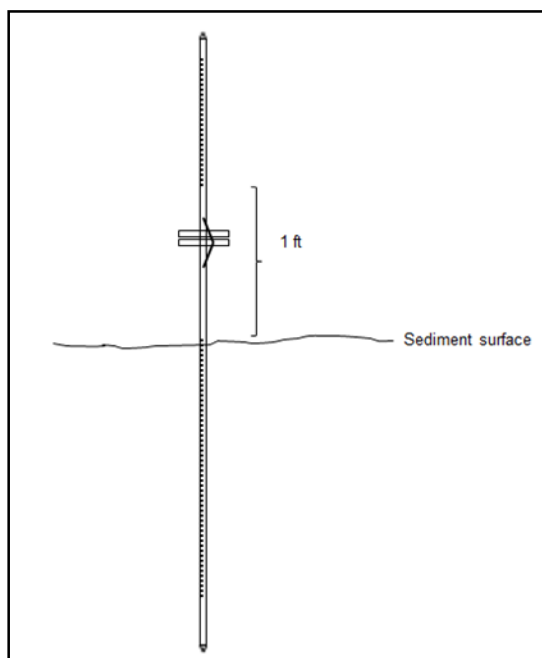

**Figure F-7. Surface-water SPME samplers were deployed 0.3 m above (i.e., one foot on the image) the sediment surface by attaching them to the top of an inserted sampler (Figure from Thomas et al. (2012))**



**Figure F-8. U.S. EPA scientific diver Brent Richmond places a SPME passive sampler at the Wyckoff Superfund Site (image by Sean Sheldrake).**

Measured (via SPME) and equilibrium partitioning (EqP) predicted concentrations were compared in the upper 10 cm of the cap where these analyses overlapped. A parity plot of the interstitial water concentrations derived from SPME samples and predicted from EqP is presented in Figure F-9 below. Data points for all locations, except for one sample at G-8, fell above the 1:1 parity line, indicating that sediment-phase concentrations using EqP over-predicted interstitial water concentration compared to measured SPME values.



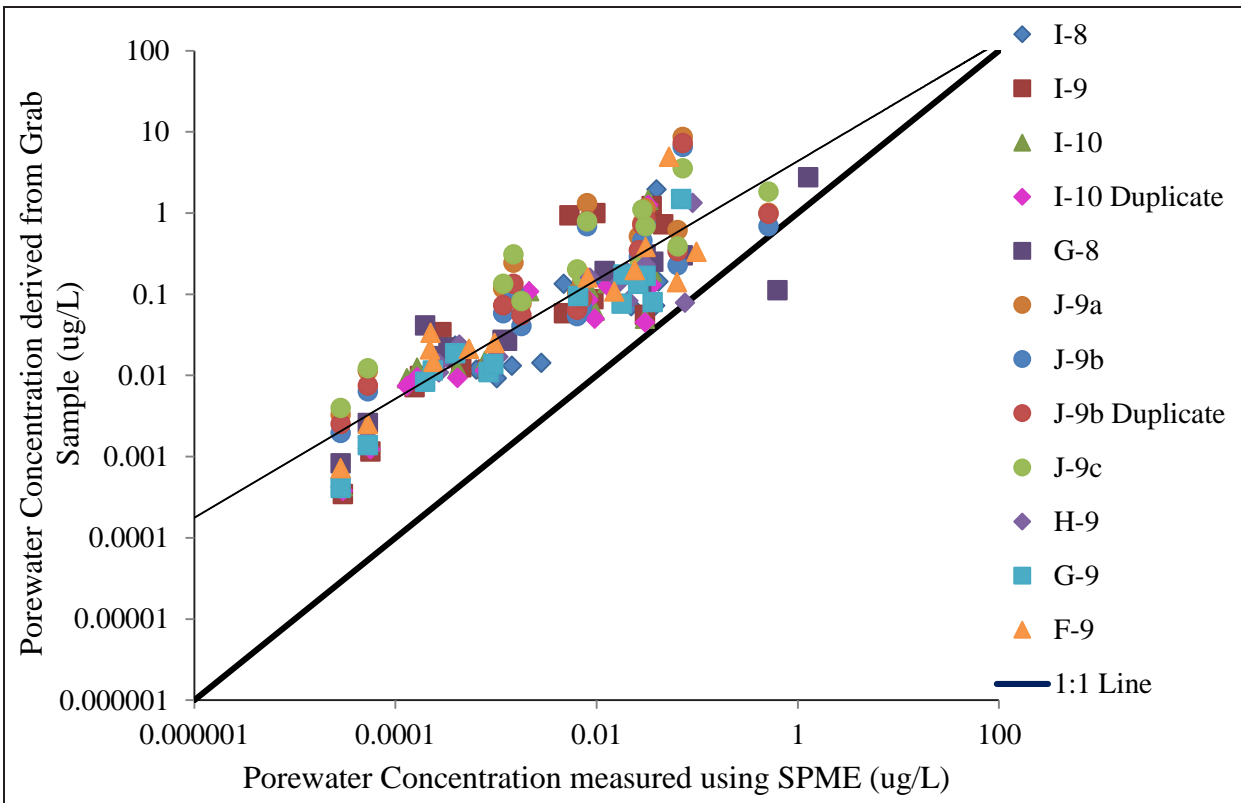

**Figure F-9. Parity plot of PAH concentrations between SPME interstitial water concentrations and interstitial water concentrations inferred by equilibrium partitioning from grab sample measurements (HDR et al. (2012)).**

### *Regulatory Use*

Efficacy of the subtidal cap was further demonstrated by the SPME data. Overall, the concentrations measured in surface samples did not exceed the AWQC, with the exception of location J-9. The OMMP report had shown there was little to no capping material over the contaminated native sediments at J-9 (HDR et al. 2012).

### *Costs*

Analytical costs were \$425/sample. This is based on a reported total cost of \$62,000 for 146 samples (Thomas et al. 2012). This cost represents only preparation and analysis time; the cost of the field deployment and retrieval by the EPA dive team was not available.

### *Site Contact*

Mandy Michelson, USACE Seattle District  
Howard Orlean, EPA Region 10, Washington.

## ***References***

HDR. 2012. *2011 year 17 monitoring report East Harbor Operable Unit Wyckoff/Eagle Harbor Superfund Site. Final dated September 7, 2012. Prepared for the U.S. Environmental Protection Agency, Region 10 Seattle WA, and the U.S. Army Corps of Engineers Seattle District.* Prepared by HDR Engineering Inc, Olympia WA; SEE LLC, Seattle, WA; Ken Taylor and Associates, Seattle, WA.

Reible, DD. 2010. SPME/PDMS calibration study. Final report to Northwest Division Seattle District US Army Corps of Engineers, April 2010.

Reible D, Lotufo G. 2012. *Demonstration and Evaluation of Solid Phase Microextraction for the Assessment of Bioavailability and Contaminant Mobility.* ESTCP Project ER-200624. Available from:  
<http://www.serdp.org/content/download/15533/176851/file/ER-200624-Guidance%20Doc.pdf>

Thomas C, Lu X, Reible D. 2012. Draft Wyckoff cap performance evaluation, solid-phase microextraction field deployment and analysis, Wyckoff/Eagle Harbor. University of Texas, Austin, TX.

## Case Study 4: United Heckathorn Superfund Site (Lauritzen Channel, Inner Richmond Harbor), California.

### Background

- Target Contaminants: DDT and degradation products (i.e., DDE and DDD), dieldrin
- Passive Sampler: Low-density polyethylene (LDPE)

### Site Narrative

The United Heckathorn Superfund site is located in the Richmond Inner Harbor of San Francisco Bay. The site includes an upland area (~5 acres) and a marine portion (~25 acres) that comprises two channels, the Lauritzen Channel and the Parr Channel. Between 1947 and 1966, onshore activities at this site included formulating, packaging, and shipping of DDT, dieldrin, and other pesticides. In 1996–1997, remedial action involved excavation and addition of a cap on the upland area, and dredging of both channels.

Post-remediation monitoring found that the remedial actions were not sufficient in the area of the Lauritzen Channel. In a five-year review published in 2011, EPA concluded that the levels of DDT in the sediments of the Lauritzen Channel were still hazardous for human and ecosystem health (US EPA, 2011). Further sampling efforts (2011–2014) at the site, including polyethylene passive samplers in the sediments and water column, were used to determine the source of the post-remediation DDT levels in the Lauritzen Channel sediments, and to inform clean-up decision making. This site is another example where U.S. EPA scientific divers from the Environmental Response Team deployed and recovered the passive samplers insuring proper sampler placement, and data quality and integrity.

### Objectives

- Delineate the problematic sediments in the Lauritzen Channel with the help of *in situ* LDPE samplers deployed at various locations in the channel
- Determine the direction and estimate the magnitude of the sediment-to-water flux based on the passive sampler deployed across the sediment/water interface
- Evaluate with a mass balance model for surface water in the channel, whether the calculated sediment-to-water fluxes can account for the observed concentrations of DDX (DDT and degrades DDE and DDD) in that water column

### Field Deployments

Polyethylene (PE) strips loaded with performance reference compounds (PRCs) were mounted in rectangular aluminum frames (Figure F-10). The samplers were deployed for 31 days at the sediment/water interface, at various sites across the channel (Figure F-11), at ten stations in 2013 [see Gschwend 2014]—and at eight stations in 2012 [see Gschwend and Burgess 2012]). With the help of divers, the samplers were pushed into the sediment bed, such that a portion of the LDPE strip remained above the sediment bed to sample the overlying bottom water. In addition, LDPE strips were deployed higher in the water column, to infer truly dissolved DDX concentrations. After retrieval, the LDPE strips were cleaned, sectioned into 5-cm pieces, and placed in VOA vials for extraction and analysis.

### Analytical Procedures

The sectioned LDPE strips were spiked with surrogate standards (also known as internal standards) and extracted three times with dichloromethane. The extracts were concentrated, exchanged to hexane, and spiked with injection compounds. Finally, the extracts

were analyzed using gas chromatography-mass spectrometry (GC-MS) with cold on column injections. Field blank samplers (i.e., LDPE strips mounted in frames and taken to the field but not deployed) were also analyzed to determine the initial PRC concentrations (procedures described in more detail in Gschwend 2014).

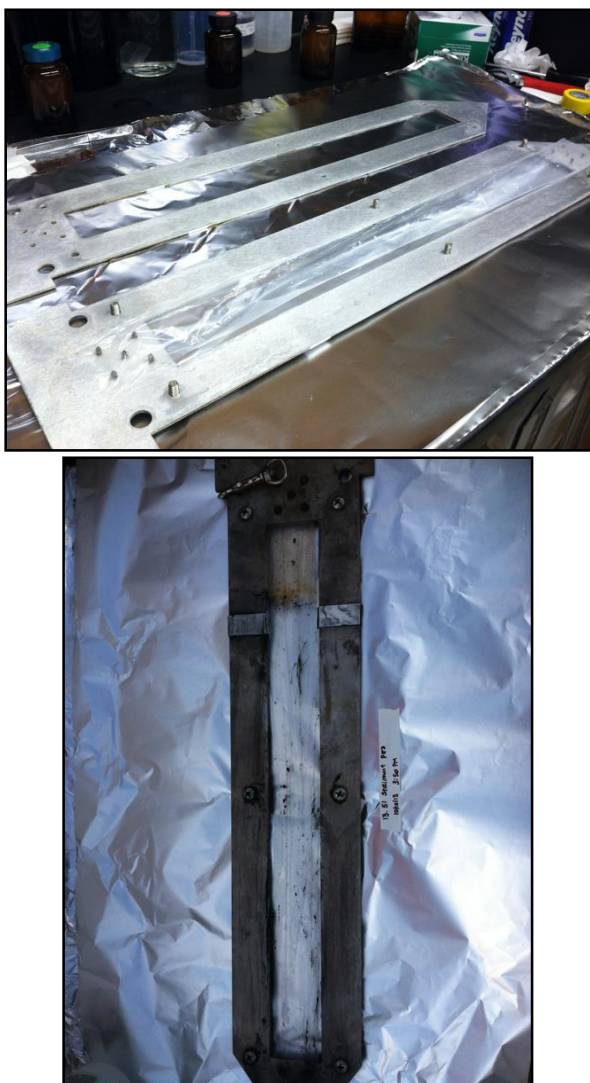

**Figure F-10.** Assembly of samplers prior to deployment (top), and a sampler after retrieval (bottom), showing the sediment/water interface right above the white tape mark. The total length of the LDPE window was ~50 cm.

To determine freely dissolved concentrations ( $C_{\text{free}}$ ), the measured concentrations of target analytes in the LDPE samplers were first corrected by the fractional equilibration calculated from the PRC loss. These LDPE concentrations were then adjusted by the low-density polyethylene-water partition coefficient of each analyte to ascertain the corresponding interstitial water or surface-water  $C_{\text{free}}$  (Equation 8-2).

### Results

Distribution of contaminants across the channel showed a gradient in concentration, with interstitial water concentrations exceeding 1000 ng/L of 4,4'-DDD in the northern-most parts of the channel and decreasing to ~10 ng/L of 4,4'-DDD in the southern-most sampling sites. The interstitial water concentrations were typically larger than the bottom-water concentrations, implying a flux out of the sediment. The differences between the interstitial water concentrations measured in the top sediment layer (5 cm) and the bottom water varied across the sampling sites, being larger in the northern than in the southern portion of the channel (Figure F-12).

Assuming that the sediment bed is the only source of contamination, and that the only removal of contaminants from the channel is due to the tidal action, a simple mass balance model was used to estimate the steady-state water-column concentration. Given the strong declining trend in interstitial water concentrations from north to south, the channel was split into four sections (or boxes), and an average sediment-to-water flux of DDT, DDE, and DDD was calculated for each box. Assuming that the tidal flushing displaced water between consecutive boxes, the steady-state concentrations of the DDX in the water column were calculated and compared to the measured concentrations from water column samplers.

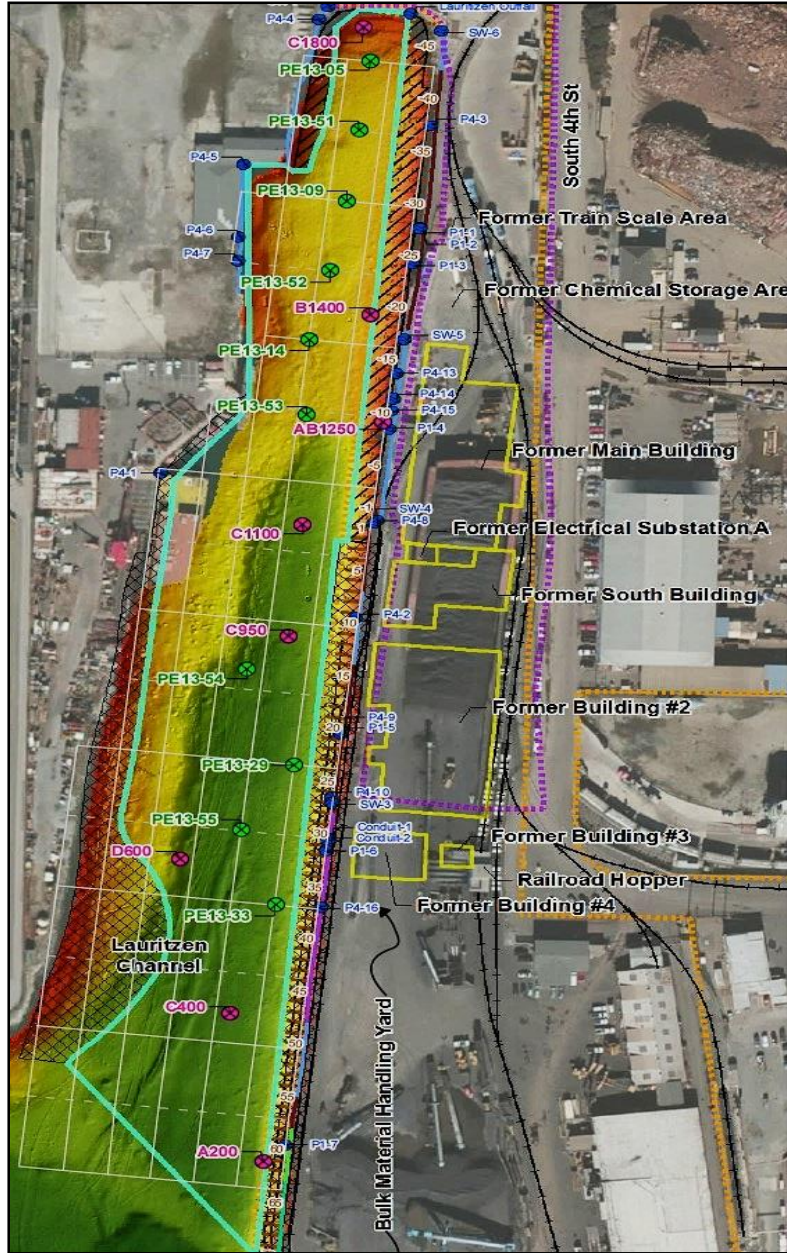
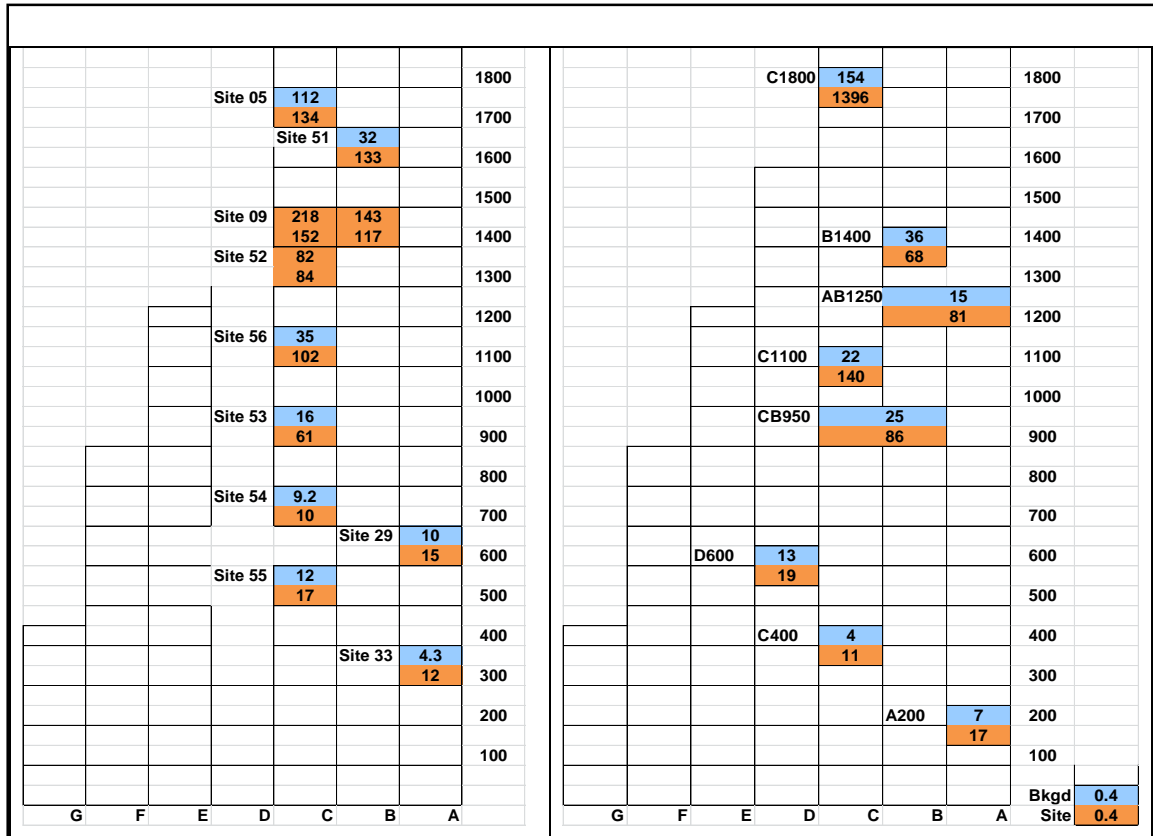

Figure F-11. Map of locations in Lauritzen Channel for deployment of samplers at the sediment/water interface in 2012 (pink) and 2013 (green).



**Figure F-12. Interstitial water (brown) and bottom water (blue) concentrations of 4,4'-DDD (ng/L), the most abundant DDX constituent, deduced using *in situ* LDPE samplers in September 2013 (left) and March 2012 (right). No bottom water concentrations could be measured at sites 09 and 53 because samplers were found fully buried at the time of retrieval.**

The mass balance model could fit the higher water column concentrations in the northern part of the channel, but the same model substantially underestimated concentrations in the south. This was particularly true for 4, 4'-DDT. This suggested the presence of an additional source of contamination to the channel, particularly in the southern part of the Channel. The signature of the contamination (4, 4'-DDT accounted for <3% of total DDX in the interstitial water, but was 15-33% in the water column for samples in the southern portion of the channel) supported the hypothesis of an additional source of unreacted insecticide (Gschwend, 2014).

### Regulatory Use

The passive sampler results were valuable with respect to delineating the contamination in the sediments of the Lauritzen Channel and establishing that the sediments of the channel (and particularly those in its north part) were a major source of the DDX contamination in the water column. Combined with mass balance modeling and "fingerprinting" of the DDX in the southern part of the system, a second source was strongly implied. The results were included in a focused feasibility study, which is part of ongoing efforts to remediate the site.

**Site Contact**

EPA Site Manager: Rachelle Thompson

415-972-3962

[thompson.rachelle@epa.gov](mailto:thompson.rachelle@epa.gov)

US EPA Region 9

Mail Code SFD

75 Hawthorne Street

San Francisco, CA 94105

**References**

USEPA (U.S. Environmental Protection Agency). 2011. Third five-year review report for United Heckathorn Superfund site, Richmond, Contra Costa County, California. September.

Gschwend, P.M., and Burgess, R.M. 2012. Application of passive samplers to assess dissolved DDTs in the Lauritzen Channel at the United Heckathorn site in Richmond Harbor, San Francisco Bay. Prepared for U.S. Environmental Protection Agency Region 9. November.

Gschwend, P. M. 2014. Application of polyethylene (PE) passive samplers to assess DDTs in the Lauritzen Channel at the United Heckathorn site in Richmond Harbor, San Francisco Bay. Included in *United Heckathorn Superfund Site, Richmond, California DDT Fate and Transport Study*, available at [http://yosemite.epa.gov/r9/sfund/r9sfdocw.nsf/3dc283e6c5d6056f88257426007417a2/d9263fb3f9c7358e88257d18005d365d/\\$FILE/Final\\_Heckathorn\\_DDT\\_FateAndTransport.pdf](http://yosemite.epa.gov/r9/sfund/r9sfdocw.nsf/3dc283e6c5d6056f88257426007417a2/d9263fb3f9c7358e88257d18005d365d/$FILE/Final_Heckathorn_DDT_FateAndTransport.pdf)

## Case Study 5: Site Assessment of Sediment Toxicity, San Diego Bay, California, USA

### Background

- Target Contaminants: Metals
- Passive Sampler: Diffusive gradients in thin films (DGTs)

### Site Narrative

The Sediment Ecotoxicity Assessment (SEA) Ring was developed as an integrated exposure and effects assessment system. Validation experiments were conducted in 2010 and 2011 in San Diego Bay, California as part of extensive proof-of-concept studies. During these studies, DGTs were deployed within SEA Ring exposure chambers (Figure F-13) to provide further assessment of labile fractions of metals in sediments (Burton et al. 2012).

Several pier areas in San Diego Bay have been listed as potentially at risk for aquatic life impacts. Four sediment locations were evaluated in San Diego Bay during the studies. Three locations used had historical data indicating sediment contamination and possibly contaminated upwelling groundwaters. A fourth location was the reference site. Test organisms deployed on the SEA Ring included the amphipod, *Leptocheirus plumulosus*, the polychaete, *Neanthes arenaceodentata*, the mysid, *Americamysis bahia*, and the clam, *Mercenaria mercenaria*. The SEA Rings contained up to 14 exposure chambers. Also, placing multiple species in a single chamber allowed for a minimum of four replicate chambers for each toxicity and bioaccumulation endpoint. Surface water and upwelling groundwaters were sampled and monitored with *in situ* water quality sensors for temperature, depth, dissolved oxygen, pH, salinity, conductivity, and oxidation-reduction potential. *In situ* interstitial water  $C_{\text{free}}$  was

measured using the solid-phase microextraction devices (SPMEs), DGTs, and Trident probe samplers for volatile organic compounds (VOCs), polycyclic aromatic hydrocarbons (PAHs), metals, and dissolved organic carbon.

### Project Objectives

- Improve on the efficiency and accuracy of site assessments of ecosystem risk and recovery (following remedial actions) by simultaneously measuring exposures of contaminants and effects in multiple species of benthic and pelagic organisms (overall).
- Provide information from the DGTs on labile metal exposures and their vertical and horizontal gradients at the test sites.

### Deployment and Retrieval of Passive Samplers

The DGTs were purchased from DGT Research, Ltd., and consisted of a diffusive gel protected by a plastic housing. DGTs were deployed within the SEA Ring surficial sediment exposure chambers using a custom holder at each of the four study locations. The DGTs were positioned vertically, so that the majority of the passive sampler would be buried in the sediment. About one-third of the device was exposed to the water column, and the remaining two-thirds contacted the sediment. The portion of the device exposed to the water column was to provide shallow interstitial water and overlying water measurements (Burton et al. 2012).

### Analytical Method

After 48 hours, the DGTs were removed, rinsed in deionized water, sectioned into 1-cm vertical slices, acidified, and analyzed for Cu, Zn, Ni, Pb, and Cd using EPA Method 200.8. Metal concentrations in elutriate were converted to DGT concentrations ( $C_{\text{DGT}}$ ) using temperature-specific diffusion coefficients (see Section 8).



## ***Results***

DGT deployments in contaminated sediments revealed gradients across the sites, with elevated levels of Zn, followed by Ni and Pb in the top 5 cm of sediments. Cu was recovered only in the deeper sediments. Toxicity and tissue residue results showed some relationships with PAHs collected in the SPMEs, but not with the labile fractions recovered in the DGTs. The metal concentrations observed in the interstitial waters were well below published toxicity thresholds. The infaunal bivalve tissue concentrations (21-day exposures) of metals suggested they were not causing toxicity.

## ***Regulatory Use***

DGTs can provide an additional line of evidence when evaluating sites that have multiple chemical contaminants and are being considered for remediation.

## ***Site Contact***

Gunther Rosen  
SPARWAR Systems Center Pacific  
53475 Strohe Rd., Bldg. 1111  
San Diego, CA 92152  
Tel 619-553-0886  
Gunther.rosen@navy.mil

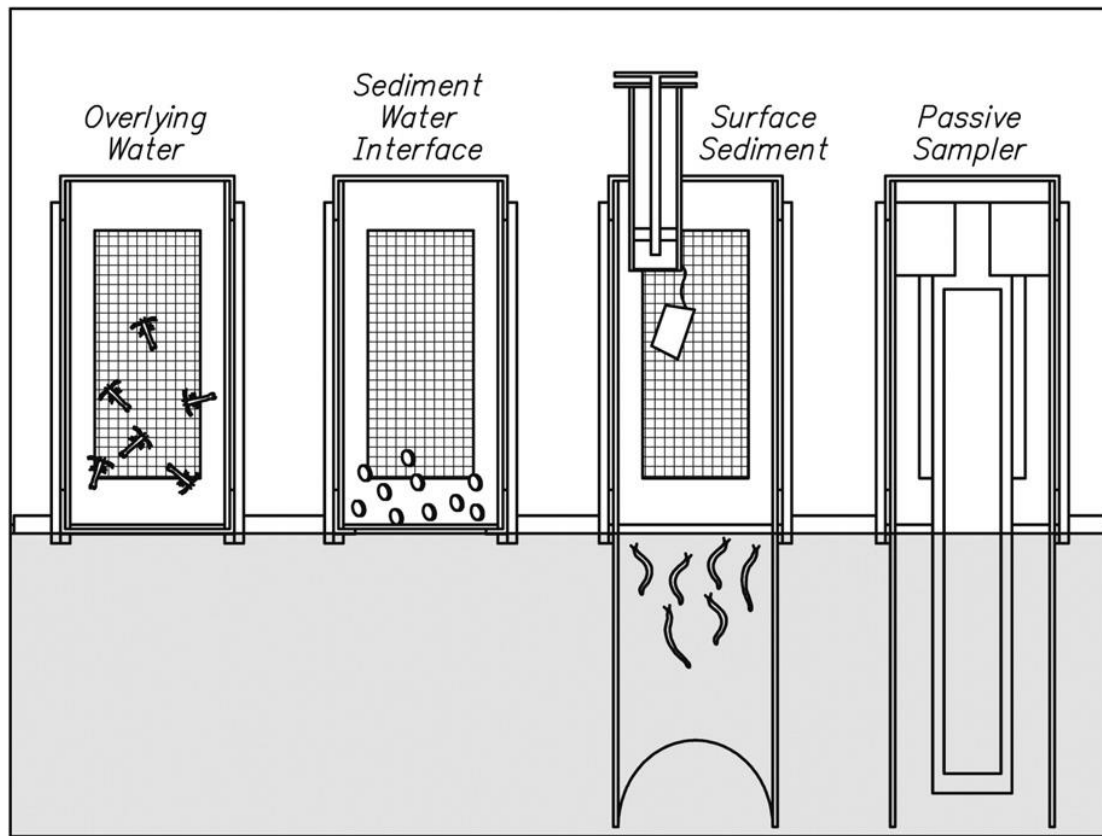

**Figure F-13.** Side view of the SEA Ring exposure chambers, including options for overlying water (WC), sediment/water interface (SWI), or surficial sediment (SED) exposures. Passive samplers are also integrated into chambers, as shown for DGT (Figure from Burton et al. (2012)).

### Reference

Burton Jr. GA, Rosen G, Chadwick DB, Greenberg MS, Taulbee WK, Lotufo GR, Reible DD. 2012. A Sediment Ecotoxicity Assessment Platform for in situ Measures of Chemistry, Bioaccumulation and Toxicity. Part 1: System Description and Proof of Concept. U.S. Navy Research. Paper 29.

## Case Study 6: *Ex situ* Passive Sampling Measurement of Site-Specific Partitioning of PAHs and PCBs in Sediments

### Background

- Target Contaminants:  
Polycyclic aromatic hydrocarbons (PAHs) and polychlorinated biphenyls (PCBs)
- Passive Sampler:  
Low density polyethylene – *ex situ* laboratory exposure

### Site Narrative

The South Wilmington Wetlands adjoining the Christiana River in Delaware has experienced historical waste disposal and impacts from past industrial and commercial activities. A 22 acre portion of the wetlands is under active investigation for potential ecological and human health concerns and options for a final remedy. Key contaminants of concern include PAHs, PCBs, a suite of metals, and pesticides. Initial site investigations indicated that several chemicals of concern present in the soils and sediments can potentially pose ecological risk to aquatic and terrestrial animals that can come in contact with the media. To advance the restoration process of the wetlands, it was determined that ‘preliminary remediation goals (PRGs)’ need to be set for the chemicals of concern allowing for conceptualization of the extent of the contamination problem and initiating evaluation of the potential remedial options for the site. Initial development of the site sediment guidelines were based on equilibrium partitioning sediment benchmarks (USEPA 2003 for PAHs and pesticides) which use organic carbon normalized partition constants ( $K_{OC}$ ) to convert water-only final chronic values (FCVs) to sediment phase Equilibrium Partitioning Sediment Benchmarks (ESB). A

very critical parameter in the calculation of the ESBs is the  $K_{OC}$ , which is often estimated for the site based on literature values. While the traditional practice uses default values for  $K_{OC}$ , recent work indicates that site specific values can often be several orders of magnitude different from default values (Hawthorne et al. 2006). U.S. EPA guidance on sediment risk assessment also cautions against the use of default values and provides suggestions for using site specific measurement of partition constants (U.S. EPA 2012a) to refine the assessment of risk. One of the reasons for the common use of default partitioning values in the past has been the difficulty and expense associated with accurate measurement of low concentrations of dissolved phase HOCs in sediments. However, recent advances in the use of passive sampling to measure equilibrium partitioning has made it possible to conveniently measure site-specific partitioning of a wide range of HOCs in sediments (U.S. EPA 2012b; Ghosh et al. 2014).

### Project Objectives

The primary objective of this study was to determine the site-specific equilibrium partitioning constants for PAHs and PCBs in sediments from the South Wilmington Wetlands and use those values to refine the development of PRGs for the site. It was anticipated that a site-specific assessment of partitioning would allow more accurate assessment of the risk posed by the chemicals of concern and the development of a more targeted management plan to reduce remaining risk.

### Laboratory Deployment

To allow accurate calculation of  $K_{OC}$  values for the strongly hydrophobic compounds, passive sampling technique was used to measure the equilibrium interstitial water concentration of PAHs and PCBs in the sediment. Briefly, the method involved

combining the wet sediment with a passive sampler in the laboratory for a period of one month. The samplers were introduced into the sediments used for the bioaccumulation experiment described below. The polyethylene passive sampler was pre-loaded with performance reference compounds (PRCs) to allow correction for non-equilibrium, especially for the strongly hydrophobic compounds. After the period of contact, the passive sampler was removed from the sediment, cleaned to remove any attached sediment particles, and extracted in hexane and acetone to measure PCBs and PAHs sorbed into the passive sampler. Values of passive sampler partition coefficients were used as described in Ghosh et al. (2014) to calculate the aqueous concentration in equilibrium with the sediment. Site-specific partition constants ( $K_{DS}$ ) for the compounds were then calculated by dividing the sediment phase concentration with the equilibrium aqueous phase concentration.

The bioaccumulation test method was based on USEPA (2000) where PCB uptake in the freshwater oligochaete (*L. variegatus*) was measured in laboratory beaker exposures as illustrated in Figure F-14.

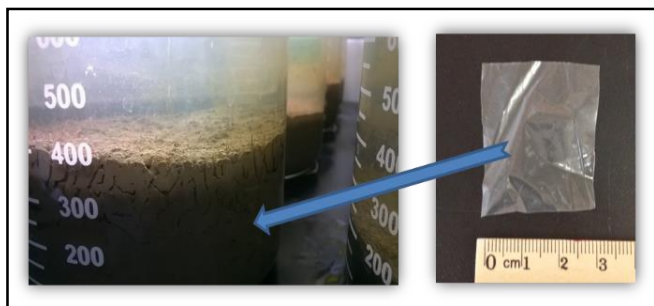

**Figure F-14. Laboratory bioaccumulation experiment using the freshwater oligochaete, *L. variegatus*, with polyethylene passive samplers inserted in exposure beakers to measure freely dissolved interstitial water concentrations of PAHs and PCBs.**

### ***Analytical Methods***

Sediment samples were extracted following U.S. EPA publication SW-846 method 3550B. PCB cleanup was based on U.S. EPA publication SW-846 methods 3630C (Silica gel cleanup), 3665A (sulfuric acid cleanup), and 3660B (Sulfur removal with copper). PCB and pesticide analysis was performed on an Agilent 6890N gas chromatograph (Restek, Bellefonte, PA, USA) with an electron capture detector and a fused silica capillary column (Rtx-5MS, 60 m x 0.25 mm i.d, 0.25  $\mu$ m film thickness). PCB standards for calibration were purchased as hexane solutions from Ultra Scientific (North Kingstown, RI, USA). Internal standards, 2,4,6-trichlorobiphenyl (PCB 30) and 2,2',3,4,4',5,6,6'-octachlorobiphenyl (PCB 204) were added to all samples. A total of about 90 PCB congeners or congener groups were measured using this method. In some cases coeluting peaks are identified and reported as the sum of congeners. A Hewlett Packard gas chromatograph (Model 6890) with a fused silica capillary column (HP-5, 30 m x 0.25 mm I.D.) and a mass spectrometer detector was used for PAH analysis based on EPA Method 8270.

### ***Results***

The total PAH concentration in sediments ranged from 0-40 mg/kg. The total PCB concentration in sediments ranged from 0-4.6 mg/kg. Out of the 15 samples, 11 were selected for partitioning and bioaccumulation measurements. The selection of the 11 samples was based on the objective of providing a range of concentrations of PCBs and PAHs in sediments, and also the availability of sufficient volumes of sediments for the studies. Partitioning measurements were performed for PCBs and PAHs, while only PCBs were measured in the bioaccumulation study. Site-specific partitioning and bioaccumulation measured for PCBs were extrapolated for the chlorinated pesticides based on a  $K_{OW}$

correlation. The organic carbon content of untreated sediment ranged from 2% to 6% with an average of 3.7% ( $\pm 1.5$ ).

Site-specific organic carbon normalized partition constants were calculated for PAHs and PCBs and compared to generic values used in the development of PRGs. The mean log  $K_{OC}$  values for PAHs were calculated from eight sediments with the highest PAH sediment concentrations. The low concentration samples were not used to avoid errors associated with calculating ratios with small, near-detection-limit numbers. As shown in Figure F-15, the measured  $K_{OC}$  values are nearly 2 orders of magnitude higher than the generic values often used in preliminary risk assessments (e.g., Karickhoff, S.W. 1981 and also those used in the calculation of draft PRGs for the site). Elevated  $K_{OC}$  values in industrially impacted sites have been observed previously. In a report based on the analysis of PAH partitioning in 117 sediment samples, Hawthorne et al (2006) reported 3-4 orders of magnitude range of site-specific  $K_{OC}$  values for individual PAHs.

The site specific  $K_{OC}$  values for PCBs were calculated from samples with the three highest sediment PCB concentrations. The measured  $K_{OC}$  values for PCBs was about an order of magnitude higher than  $K_{OC}$  values reported in Schwarzenbach et al. (2003) which is often used in site risk calculations. The measured bioaccumulation in worms was well predicted based on site-specific measurement of interstitial water concentrations in sediments and generic bioaccumulation factor values.

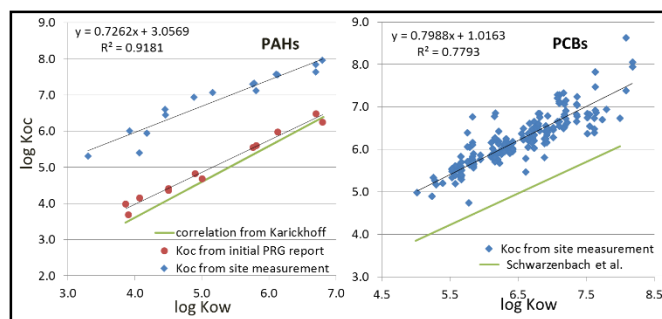

**Figure F-15. Measured site-specific partition constants for PAHs and PCBs in sediments compared to generic values based on Karickhoff et al. (1981) and Schwarzenbach et al. (2003), respectively.**

### Regulatory Use

The results from this study and refined PRG estimates were submitted to the Delaware Department of Natural Resources and Environmental Control and are being used for delineation of the area for active restoration and decision making on the final remedy for the site.

### Site Contact

Upal Ghosh, UMBC. [ughosh@umbc.edu](mailto:ughosh@umbc.edu)

### References

- Hawthorne SB, Grabanski CB, Miller DJ. 2006. Measured partitioning coefficients for parent and alkyl polycyclic aromatic hydrocarbons in 114 historically contaminated sediments: Part 1.  $K_{OC}$  values. *Environ Toxicol Chem* 25:2901–2911.
- Ghosh U, S Kane Driscoll, RM Burgess, M Jonker, D Reible, F Gobas, Y Choi, S Apitz, K Maruya, W Gala, M Mortimer, C Beegan 2014. Passive sampling methods for contaminated sediments: Practical guidance for selection, calibration and implementation. *Integr Environ Assess Manage* 10:210–223.

Karickhoff SW. 1981. Semi-empirical estimation of sorption of hydrophobic pollutants on natural sediments and soils. *Chemosphere* 10(8):833–846.

Lohmann R, Macfarlane JK, Gschwend PM. 2005. Importance of black carbon to sorption of native PAHs, PCBs and PCDDs in Boston and New York harbor sediment. *Environ. Sci. Technol.* 39:141–148.

Schwarzenbach RP, Gschwend PM, Imboden, DM. 2003. *Environmental Organic Chemistry*. John Wiley and Sons. Princeton, NJ.

U.S. EPA 2012a. *Equilibrium Partitioning Sediment Benchmarks (ESBs) for the Protection of Benthic Organisms: Procedures for the Determination of the Freely Dissolved Interstitial Water Concentrations of Nonionic Organics*. EPA/600/R-02/012. Office of Research and Development. Washington, DC.

U.S. EPA 2012b. *Guidelines for Using Passive Samplers to Monitor Organic Contaminants at Superfund Sediment Sites*. OSWER Directive 9200.1–110FS. Office of Research and Development. Washington, DC.

U.S. EPA. 2003. *Procedures for the derivation of equilibrium partitioning sediment benchmarks (ESBs) for the protection of benthic organisms: PAH mixtures*. EPA-600-R-02-013. Office of Research and Development, Washington, DC.

U.S. EPA. 2000. *Methods for Measuring the Toxicity and Bioaccumulation of Sediment Associated Contaminants with Freshwater Invertebrates*. EPA/600/R-99/064, Office of Research and Development, Washington, DC.

Werner D, Hale SE, Seokjoon K, Ghosh U, Luthy RG. 2011. Polychlorinated biphenyl sorption and availability in field-contaminated sediments. *Environ Sci Technol* 44:2809–2815.

# Appendix G: Example Quality Assurance Project Plan (QAPP)

Two examples of quality assurance project plans (QAPPs) are provided in Appendix G.

The first example is a interstitial water Sampling and Analysis Plan (SAP) that was prepared for the U.S. EPA's Region 10 as part of the River Mile 11 East (RM11E) Supplemental Remedial Investigation and Feasibility Study. The plan was prepared on behalf of the RM11E Group by Science and Engineering for the Environment, LLC (SEE), Dalton, Olmstead and Fuglevand, Inc. (DOF), and GSI Water Solutions, Inc. (GSI). The SAP was prepared in response to U.S. EPA's communications to the RM11E Group requiring the performance of a interstitial water investigation as part of the data gathering effort under the project work plan. PCBs were the focus of the study.

The second example was prepared for the U.S. EPA's Region 9 Superfund program for water column-based passive sampling research investigating the flux of dissolved chlorinated pesticides (i.e., DDTs) and PCBs from contaminated sediments into the water column. Note that standard operating procedures (SOPs) appended to the plan were prepared by the Southern California Coastal Water Research Project (SCCWRP), Costa Mesa, California, USA.

These documents can be found at these sites:

<https://www.epa.gov/superfund/superfund-contaminated-sediments-guidance-documents-fact-sheets-and-policies>.

and

<https://www.serdp-estcp.org/Featured-Initiatives/Cleanup-initiatives/Bioavailability>

Further guidance on the preparation of a QAPP is available from the Intergovernmental Data Quality Task Force document, *Uniform Federal Policy for Quality Assurance Project Plan. Evaluating, Assessing, and Documenting Environmental Data Collection and Use Programs. Part 1: UFP-QAPP Manual Final Version 1. March 2005*, EPA: EPA-505-B-04-900A DoD: DTIC ADA 42778. The document can also be downloaded from:

[https://www.epa.gov/sites/production/files/documents/ufp\\_qapp\\_v1\\_0305.pdf](https://www.epa.gov/sites/production/files/documents/ufp_qapp_v1_0305.pdf)