

Fluctuation of Indoor Radon and VOC Concentrations Due to Seasonal Variations

Fluctuation of Indoor Radon and VOC Concentrations Due to Seasonal Variations

Prepared for

U.S. Environmental Protection Agency
National Exposure Research Laboratory
Las Vegas, NV 89119

Prepared by

RTI International
3040 Cornwallis Road
Research Triangle Park, NC 27709

and

ARCADIS U.S., Inc.
4915 Prospectus Drive, Suite F
Durham, NC 27713

RTI Project Number 0213151.001

Although this work was reviewed by EPA and approved for publication, it may not necessarily reflect official Agency policy. Mention of trade names and commercial products does not constitute endorsement or recommendation for use.

U.S. Environmental Protection Agency
Office of Research and Development
Washington, DC 20460

Table of Contents

1.	Executive Summary	1-1
1.1	Background.....	1-1
1.2	Purpose and Objectives	1-1
1.3	Conclusions	1-2
1.3.1	Seasonal Variation and Influence of HVAC	1-2
1.3.2	Relationship Between Subsurface and Indoor Air Concentrations	1-3
1.4.3	Relationship Between Radon and VOCs.....	1-3
1.3.4	Conclusions: The Use of External Soil Gas Samples as a Surrogate Sampling Location.....	1-3
1.3.5	Conclusions: The Duration Over Which Passive Samplers (Solvent Extracted Radial Style Charcoal) Provided Useful Integration of Indoor Air Concentrations.....	1-4
1.3.6	Conclusions: Groundwater vs. Vadose Zone Sources as Controls on Indoor Concentrations at This Site.....	1-4
2.	Introduction	2-1
2.1	Background.....	2-2
2.1.1	Variability in Vapor Intrusion Studies	2-3
2.1.2	Vapor Attenuation Factors	2-7
2.1.3	Potential for Use of Radon as a Vapor Intrusion Tracer	2-8
2.1.4	Passive VOC Sampling	2-10
2.2	Objectives	2-14
2.2.1	Time Scale and Measurement of Independent and Dependent Variables	2-15
2.2.2	Data Quality Objectives and Criteria	2-16
3.	Methods.....	3-1
3.1	Site Description	3-1
3.1.1	Area Geology/Hydrogeology	3-1
3.1.2	Area Potential Sources	3-3
3.1.3	Building Description	3-7
3.1.4	Building Occupancy During Sampling	3-9
3.1.5	Initial Site Screening	3-9
3.1.6	Initial Conceptual Site Model.....	3-13
3.2	Building Renovation.....	3-14
3.2.1	HVAC Refurbishment and Operations.....	3-14
3.2.2	Plumbing Refurbishment and Sealing.....	3-17
3.3	Monitoring Infrastructure Installation (Wells, SGPs, Embedded Temperature Sensors).....	3-18
3.4	VOC Sampling and Analysis.....	3-23
3.4.1	Indoor (Passive, Summa Canister)	3-23
3.4.2	Subslab and Soil Gas (TO-17 and Summa Canister)	3-25
3.4.3	Online Gas Chromatograph.....	3-25
3.4.4	Groundwater.....	3-27
3.5	Radon Sampling and Analysis.....	3-27
3.5.1	Indoor Air Radon Sampling and Analysis.....	3-27
3.5.2	Subslab and Soil Gas Radon Sampling and Analysis	3-28
3.5.3	Continuous (Real-Time) Indoor Air Radon Sampling and Analysis	3-29
3.6	Physical Parameters Monitoring.....	3-29
3.6.1	On-Site Weather Station.....	3-29
3.6.2	Indoor Temperature.....	3-31
3.6.3	Soil Temperature	3-31

3.6.4	Soil Moisture	3-31
3.6.5	Potentiometric Surface/Water Levels.....	3-32
3.6.6	Differential Pressure.....	3-32
3.6.7	Air Exchange Rate	3-32
3.6.8	Crack Monitoring	3-33
4.	Results and Discussion: Quality Assurance Checks of Individual Data Sets.....	4-1
4.1	VOC Sampling—Indoor Air-Passive—Air Toxics Ltd. (ATL)	4-1
4.1.1	Blanks.....	4-1
4.1.2	Surrogate Recoveries.....	4-3
4.1.3	Laboratory Control Sample Recoveries	4-3
4.1.4	Duplicates.....	4-3
4.2	VOC Sampling—Subslab and Soil Gas (TO-17)—U.S. EPA.....	4-4
4.2.1	Blanks.....	4-4
4.2.2	Surrogate Recoveries.....	4-7
4.2.3	Laboratory Control Sample Recoveries	4-7
4.3	VOC Sampling—Subslab and Soil Gas (TO-17)—ATL	4-8
4.3.1	Blanks.....	4-8
4.3.2	Surrogate Recoveries.....	4-10
4.3.3	Laboratory Control Sample Recoveries	4-11
4.3.4	Duplicates.....	4-11
4.4	VOC Sampling—Subslab and Indoor Air (TO-15)—ATL	4-12
4.4.1	Blanks.....	4-12
4.4.2	Surrogate Recoveries.....	4-13
4.4.3	Laboratory Control Sample Recoveries	4-13
4.4.4	Duplicates.....	4-14
4.5	Online GC (Soil Gas and Indoor Air).....	4-14
4.5.1	Blanks.....	4-14
4.5.2	Initial Calibration	4-15
4.5.3	Continuing Calibration.....	4-15
4.5.4	Calibration Check via Comparison to Fixed Laboratory (TO-15 vs. Online GC).....	4-15
4.5.5	Agreement of Online GC Results with TO-17 Verification Samples	4-16
4.5.6	Agreement of Integrated Online GC Results with Passive Samplers.....	4-18
4.6	Radon.....	4-25
4.6.1	Indoor Air: Comparison of Electrets Field, ARCADIS to Charcoal Analyzed by U.S. EPA Radiation and Indoor Environment (R&IE) National Laboratory	4-25
4.6.2	Comparison of Average of Real Time Alphaguard to Electrets and Charcoal Canisters.....	4-28
4.6.3	Quality Assurance Checks of Electrets	4-30
4.7	On-Site Weather Station vs. National Weather Service (NWS).....	4-31
4.8	Database	4-33
4.8.1	Checks on Laboratory Reports.....	4-33
4.8.2	Database Checks	4-34
5.	Results and Discussion: VOC Concentration Temporal Trends and Relationship to HVAC	5-1
5.1	VOC Seasonal Trends Based on Weekly, Biweekly, and Monthly Measurements for 52+ Weeks.....	5-1
5.1.1	Indoor Air.....	5-1
5.1.2	Subslab Soil Gas.....	5-4
5.1.3	Shallow and Deep Soil Gas	5-8
5.2	Radon Seasonal Trends (based on Weekly Measurements).....	5-23

5.2.1	Indoor Air.....	5-23
5.2.2	Subslab and Wall Port Soil Gas	5-26
5.2.3	Deep Soil Gas.....	5-29
5.3	VOC Short-Term Variability (Based on Daily and Hourly VOC Sampling).....	5-35
5.3.1	Indoor air	5-35
5.3.2	Subsurface Soil Gas Data	5-41
5.4	Radon Short Term Variability (Based on Daily and More Frequent Measurements)	5-48
5.4.1	Indoor Air.....	5-48
5.4.2	Subslab, Wall Port, and Deeper Soil Gas Radon Data	5-52
5.5	Outdoor Climate/Weather Data	5-52
6.	Results and Discussion: Establishing the Relationship between VOCs and Radon in Subslab/Subsurface Soil Gas and Indoor Air	6-1
6.1	Correlation between Soil Gas VOC and Radon Concentrations	6-3
6.2	Correlation between the Indoor Air Concentration and Radon	6-15
6.3	Radon and VOC Soil Gas Spatial Distributions.....	6-16
6.4	Spatial Correlations in Radon and VOCs Analyzed Separately	6-18
6.5	Correlations in Indoor Air VOC and Radon Temporal Trends	6-22
7.	Results and Discussion: Attenuation of Soil Gas VOCs and Radon	7-1
7.1	Subslab to Indoor Air Attenuation Factor Temporal Range.....	7-1
7.2	Subslab Attenuation Factors for Each Side of the Duplex	7-3
7.3	Attenuation Factors Calculated for Each Side of the Duplex Using Subslab and Shallow Soil Gas Samples.....	7-6
8.	Results and Discussion: Can Near-Building External Samples Be Used as a Surrogate Sampling Location?.....	8-1
8.1	Comparison of External Soil Gas to Subslab Soil Gas.....	8-1
8.1.1	Chloroform	8-1
8.1.2	Tetrachloroethylene (PCE).....	8-2
8.1.3	Trichloroethylene (TCE)	8-3
8.1.4	Radon	8-4
8.2	Comparison of Wall Ports to Subslab External Soil Gas.....	8-5
9.	Results and Discussion: Over what durations do solvent extracted passive samplers provide useful integration of indoor air concentrations? (Is uptake rate constant?).....	9-1
9.1	Comparison of Daily to Weekly Samples	9-5
9.2	Comparison of Weekly to Biweekly Samples	9-8
9.3	Comparison of Weekly to Monthly Samples.....	9-9
9.4	Comparison of Weekly to Quarterly Samples	9-10
9.5	Comparison of Weekly to Semiannual and Annual Samples.....	9-10
9.5.1	Comparing Radiello Samplers to SKC Samplers.....	9-11
9.6	Conclusions	9-12
10.	Results and Discussion: Determine if observed changes in indoor air concentration of volatile organics of interest are mechanistically attributable to changes in vapor intrusion	10-1
10.1	Air Exchange Rate Results and Seasonal Variability—Does this Control Indoor Air Concentration?.....	10-1
10.2	Direct Differential Pressure Results—Are They Predictive of Indoor Air Concentrations by Themselves?	10-3
10.3	Inferred Driving Force from Temperature Differentials—Is This Predictive of Indoor Air Concentrations by Itself?.....	10-8
10.4	HVAC System Cycles	10-12

10.5	Trends in Subslab Concentration—Do They Predict Indoor Air Concentration Trends by Themselves?	10-16
10.6	Do Trends In Shallow and Deep Soil Gas Predict Indoor Air Concentrations?	10-16
10.7	Ambient Concentrations—Are They Significant?.....	10-17
10.8	Potentiometric Surface/Water Levels—Do They Predict Subslab Concentrations?	10-17
11.	Results and Discussion: Do groundwater concentrations control soil gas concentrations at this site? And thus indoor air concentrations?	11-1
11.1	Potentiometric Surface Changes (and Correlation to Local Surface Water Bodies)	11-1
11.2	Groundwater Concentration Trend.....	11-5
11.2.2	Is the Groundwater Concentration Trend Correlated to Potentiometric Surface?.....	11-8
11.2.3	Is the Groundwater Concentration Trend Correlated to Indoor Air Concentrations?.....	11-8
11.3	Soil Moisture Trends	11-8
11.3.1	Correlation with Rainfall Measurements.....	11-8
11.3.3	Relationship to Observed Stratigraphy.....	11-9
11.4	Correlation of Groundwater Concentration Changes to Deep Soil Gas	11-11
11.5	Revisions to Conceptual Site Model	11-14
12.	Results and Discussion: Special Studies	12-1
12.1	Summary of Temporary vs. Permanent Subslab Sampling Study	12-1
12.2	Summary of Fan Testing	12-1
12.2.1	Fan Test Objectives	12-3
12.2.2	Fan Test Experimental Methods.....	12-3
12.2.3	Fan Test Results and Discussion	12-4
12.2.4	Fan Test Lessons Learned	12-11
12.3	Testing Utility of Consumer-Grade Radon Device (Safety Siren Pro)	12-11
12.3.1	Consumer-Grade Radon Device Test Objectives.....	12-12
12.3.2	Consumer-Grade Radon Device Test Methods	12-12
12.3.3	Consumer-Grade Radon Detector Test Results and Discussion	12-12
13.	Conclusions and Recommendations	13-2
13.1	Conclusions	13-2
13.1.1	Seasonal Variation and Influence of HVAC	13-2
13.1.2	The Relationship Between Subsurface and Indoor Air Concentrations	13-2
13.1.3	The Relationship Between Radon and VOCs	13-3
13.1.4	The Use of External Soil Gas Samples as a Surrogate Sampling Location	13-3
13.1.5	The Duration Over Which Passive Samplers (Solvent Extracted Radial Style Charcoal) Provided Useful Integration of Indoor Air Concentrations	13-3
13.1.6	Groundwater vs. Vadose Zone Sources as Controls on Indoor Concentrations at this Site	13-4
13.2	Practical Implications for Practitioners	13-4
13.2.1	Sampling to Characterize Seasonal Variations.....	13-4
13.2.2	Using Fan Induced Depressurization in Vapor Intrusion Studies	13-5
13.2.3	Performance of Temporary Subslab Sampling Ports	13-5
13.2.4	Performance of Consumer Grade Radon Detector	13-6
13.3	Recommendations	13-6
13.3.1	Recommendations for Vapor Intrusion Research Generally	13-6
13.3.2	Recommendations Regarding Further Study of this Test Site	13-7
14.	References	14-1

Appendix A: Soil Boring Logs

Appendix B: Temporary vs. Permanent Subslab Port Study

List of Figures

2-1.	An overview of important vapor intrusion pathways (U.S. EPA, 2002a).....	2-2
2-2.	Soil gas and groundwater concentrations below a slab (Schumacher et al., 2010).....	2-6
3-1.	Lithological fence diagram showing the major soil types beneath the 422/420 house.....	3-2
3-2.	Aerial view of duplex, 420/422 East 28th Street, showing nearby sanitary and storm sewers.....	3-3
3-3.	East side of house (on right) and adjoining commercial quadraplex visible (left).	3-4
3-4.	Roof of adjacent commercial quadraplex.	3-4
3-5.	Looking toward southeast corner of adjacent commercial quadraplex.....	3-5
3-6.	Visual evidence of historic dry cleaners in area.	3-6
3-7.	Front view of house during summer 2011 sampling, with fan testing and weather station.....	3-7
3-8.	Front view of duplex under winter conditions showing designation of sides and HVAC setup.....	3-8
3-9.	422 (left) and 420 East 28th Street in January 2011.	3-8
3-10.	Test building floor plan showing sampling locations used in preliminary screening.....	3-11
3-11.	Basement supply register in newly installed HVAC system.	3-14
3-12.	Common returns from first and second floors in newly installed HVAC system.....	3-15
3-13.	Gas-fired forced hot air HVAC system installed in 422.	3-15
3-14.	Floor cracks in 422 basement, central area, contrast enhanced.	3-17
3-15.	Weathered cement in walls and floor cracks in 422, contrast enhanced.....	3-17
3-16.	Floor drain, 422, 1st floor laundry area.	3-18
3-17.	Nested monitoring well 1 and SGP1 are located immediately south of the 422 side front wall. SGP1-16.5 and MW-1A is by the wall, to the left of the sign. SGP1-9 and 1-13 as well as MW-1C are by the wall, to the right of the sign (next to the pile of bricks). SGP1- 3.5 and 1-6, and MW-1B are in the installation visible in the center foreground.....	3-19
3-18.	Exterior of test building showing utility corridors, ground surface cover, monitoring wells (MWs), soil gas points (SGPs), thermocouples (TCs), and moisture sensors (MSs).	3-20
3-19.	Interior floor plans of 420 and 422 East 28th Street showing sampling locations.....	3-21
3-20.	Interior SGP9 (top) and SSP-4 (bottom).....	3-22
3-21.	Wall port 2.	3-22
3-22.	Passive indoor air sampling rack: 422 first floor.	3-23
3-23.	Ambient sampler shelters on telephone pole near duplex.....	3-24
3-24.	Monitoring well MW-3, installed in the basement and completed on the first floor.....	3-27
3-25.	Front view of 420/422 duplex with location of weather station sensors indicated with red arrow.	3-30
3-26.	Calibrated crack monitor.....	3-33
4-1.	Correlation between radon measured using the electret and charcoal methods.....	4-27
4-2.	Aerial view of study house, showing potential influences on wind velocity; red arrow indicates study house.	4-32
4-3.	Comparison of National Weather Service Indianapolis temperature data to weather station at 422 East 28th Street.....	4-32
4-4.	Comparison of National Weather Service Indianapolis relative humidity to weather station at 422 East 28th Street.....	4-33
4-5.	Comparison of National Weather Service wind speed data to weather station at 422 East 28th Street.	4-33
5-1.	PCE in indoor and ambient air vs. time (7-day Radiello samples).	5-2

5-2.	Chloroform in indoor and ambient air vs. time (7-day Radiello samples).....	5-2
5-3.	PCE, benzene, and toluene in indoor and ambient air.	5-3
5-4.	PCE and chloroform in 422 first-floor indoor air; weekly, biweekly, and monthly duration Radiello samples.....	5-3
5-5.	Plot of subslab chloroform concentrations vs. time.	5-4
5-6.	Plot of subslab chloroform concentrations vs. time, first intensive sampling period.	5-5
5-7.	Plot of subslab PCE concentrations vs. time.....	5-6
5-8.	Plot of subslab PCE concentrations vs. time, first intensive sampling period.	5-6
5-9.	Plot of wall port chloroform concentrations vs. time.....	5-7
5-10.	Plot of wall port PCE concentrations vs. time.	5-8
5-11.	Chloroform concentrations at each of the SGP1 ports vs. time.	5-11
5-12.	PCE concentrations at each of the SGP1 ports vs. time.....	5-11
5-13.	Chloroform concentrations at each of the SGP2 ports vs. time.	5-12
5-14.	PCE concentrations at each of the SGP2 ports vs. time.....	5-12
5-15.	Chloroform concentrations at each of the SGP3 ports vs. time.	5-13
5-16.	PCE concentrations at each of the SGP3 ports vs. time.....	5-13
5-17.	Chloroform concentrations at each of the SGP4 ports vs. time.	5-14
5-18.	PCE concentrations at each of the SGP4 ports vs. time.....	5-14
5-19.	Chloroform concentrations at each of the SGP5 ports vs. time.	5-15
5-20.	PCE concentrations at each of the SGP5 ports vs. time.....	5-15
5-21.	Chloroform concentrations at each of the SGP6 ports vs. time.	5-16
5-22.	PCE concentrations at each of the SGP6 ports vs. time.....	5-16
5-23.	Chloroform concentrations at each of the SGP7 ports vs. time.	5-17
5-24.	PCE concentrations at each of the SGP7 ports vs. time.....	5-17
5-25.	Chloroform concentrations at SGP8 and 9 ports vs. time.....	5-18
5-26.	PCE concentrations at SGP8 and 9 ports vs. time.	5-18
5-27.	Chloroform concentrations at each of the SGP10 ports vs. time.	5-19
5-28.	PCE concentrations at each of the SGP10 ports vs. time.....	5-19
5-29.	Chloroform concentrations at each of the SGP11 ports vs. time.	5-20
5-30.	PCE concentrations at each of the SGP11 ports vs. time.....	5-20
5-31.	Chloroform concentrations at each of the SGP12 ports vs. time.	5-21
5-32.	PCE concentrations at each of the SGP12 ports vs. time.....	5-21
5-33.	Subslab PCE concentrations over a 1-week period during the first intensive round.	5-22
5-34.	Subslab PCE concentrations over a 1-week period during the second intensive round.	5-22
5-35.	Weekly electret readings for all locations.....	5-24
5-36.	Data for the downstairs continuously recording Alphaguard versus time.	5-25
5-37.	Data for the upstairs continuously recording Alphaguard versus time.	5-26
5-38.	This is a kriged radon image taken from subslab, wall, and multidepth soil gas data.	5-27
5-39.	Subslab Alphaguard data versus time.	5-28
5-40.	Wall port Alphaguard data versus time.....	5-28
5-41.	Kriged radon image taken from subslab, wall, and multidepth soil gas data.....	5-30
5-42.	Handheld Alphaguard data taken from soil gas ports at location 1 versus time.	5-31
5-43.	Handheld Alphaguard data taken from soil gas ports at location 4 versus time.	5-31
5-44.	Handheld Alphaguard data taken from soil gas ports at location 5 versus time.	5-32
5-45.	Handheld Alphaguard data taken from soil gas ports at location 7 versus time.	5-32
5-46.	Handheld Alphaguard data taken from soil gas ports at location 8 versus time.	5-33
5-47.	Handheld Alphaguard data taken from soil gas ports at location 9 versus time.	5-33
5-48.	Handheld Alphaguard data taken from soil gas ports at location 10 versus time.	5-34
5-49.	Handheld Alphaguard data taken from soil gas ports at location 11 versus time.	5-34
5-50.	Handheld Alphaguard data taken from soil gas ports at location 12 versus time.	5-35
5-51.	Online GC chloroform indoor air data for 422 first floor.	5-36

5-52.	Online GC chloroform indoor air data for 422 basement.	5-36
5-53.	Online GC chloroform indoor air data for 420 first floor.	5-38
5-54.	Online GC chloroform indoor air data for 420 basement.	5-38
5-55.	Online GC PCE indoor air data for 422 first floor.	5-39
5-56.	Online GC PCE indoor air data for 422 basement.	5-39
5-57.	Online GC PCE indoor air data for 420 first floor.	5-40
5-58.	Online GC PCE indoor air data for 420 basement.	5-40
5-59.	Online GC subsurface chloroform soil gas data—Phase 1 and Phase 2.	5-42
5-60.	Online GC subsurface chloroform soil gas data—Phase 1.	5-42
5-61.	Online GC subsurface chloroform soil gas data—Phase 2.	5-43
5-62.	Online GC subsurface PCE soil gas data—Phase 1 and Phase 2.	5-44
5-63.	Online GC subsurface PCE soil gas data—Phase 1.	5-44
5-64.	Online GC subsurface PCE soil gas data—Phase 2.	5-45
5-65.	Method TO-17 data for SSP-4.	5-46
5-66.	Online GC PCE measurements in SSP-4.	5-46
5-67.	Comparison of online GC measurements of PCE and chloroform in SGP9 at 6 ft.	5-47
5-68.	Electret indoor air radon concentrations for the first intensive round.	5-49
5-69.	Electret indoor air radon concentrations for the second intensive round.	5-49
5-70.	Radon concentrations from the downstairs stationary Alphaguard during the second intensive round.	5-50
5-71.	Radon concentrations from the upstairs stationary Alphaguard during the second intensive round.	5-50
5-72.	Electret indoor air radon concentrations for the third intensive round.	5-51
5-73.	Radon concentrations from the downstairs stationary Alphaguard during the third intensive round.	5-51
5-74.	Radon concentrations from the upstairs stationary Alphaguard during the third intensive round.	5-52
5-75.	Temperature records from the external temperature monitor and the HOBO devices at seven indoor locations on the 422 and 420 sides of the house.	5-54
5-76.	Indoor temperature as recorded inside the 422 second floor office.	5-55
5-77.	Stacked hydrological graph with depth to water in feet (top—red circles), discharge at Fall Creek in ft ³ /s (middle—blue line), and rainfall in inches (bottom—green line).	5-56
5-78.	Plot of barometric pressure (inches of Hg) external to the 422/420 house over time.	5-57
5-79.	Barometric pressure (Pa) on the 422 side of the house over time.	5-58
6-1.	Temporal trends and cross-correlograms of chloroform (red), PCE (green), and radon (blue) for SGP11 at 6 ft bls.	6-4
6-2.	Temporal trends and cross-correlograms of chloroform (red), PCE (green), and radon (blue) for SGP1 at 9 ft bls.	6-5
6-3.	Temporal trends and cross-correlograms of chloroform (red), PCE (green), and radon (blue) for SGP4 at 9 ft bls.	6-6
6-4.	Temporal trends and cross-correlograms of chloroform (red), PCE (green), and radon (blue) for SGP4 at 13 ft bls.	6-7
6-5.	Temporal trends and cross-correlograms of chloroform (red), PCE (green), and radon (blue) for SGP5 at 9 ft bls.	6-8
6-6.	Temporal trends and cross-correlograms of chloroform (red), PCE (green), and radon (blue) for SGP7 at 9 ft bls.	6-9
6-7.	Temporal trends and cross-correlograms of chloroform (red), PCE (green), and radon (blue) for SGP8 at 6 ft bls.	6-10
6-8.	Temporal trends and cross-correlograms of chloroform (red), PCE (green), and radon (blue) for SGP9 at 6 ft bls.	6-11

6-9.	Temporal trends and cross-correlograms of chloroform (red), PCE (green), and radon (blue) for SGP10 at 6 ft bls.	6-12
6-10.	Temporal trends and cross-correlograms of chloroform (red), PCE (green), and radon (blue) for SGP11 at 6 ft bls.	6-13
6-11.	Temporal trends and cross-correlograms of chloroform (red), PCE (green), and radon (blue) for SGP12 at 6 ft bls.	6-14
6-12.	Cross-correlation plots for the time series of log-VOCs and radon by indoor air location.	6-15
6-13.	Comparison of nearly collocated subslab and shallow internal soil gas ports.	6-17
6-14.	Concentration distributions ($\mu\text{g}/\text{m}^3$ [VOCs] or pCi/L [radon]) and significance tests for nearly collocated subslab and shallow internal soil gas ports.	6-18
6-15.	Evaluation of spatial effect north and south basement by VOC and radon for 422 East 28th St.—cumulative distribution plots where the x axis represents concentration ($\mu\text{g}/\text{m}^3$ or pCi/L) and the y-axis concentration.	6-19
6-16.	Evaluation of spatial effect north and south basement by VOC and radon for 420 East 28th Street—cumulative distribution plots where the x axis represents concentration ($\mu\text{g}/\text{m}^3$ or pCi/L) and the y-axis concentration.	6-19
6-17.	Cross-correlation between north and south basement indoor air by VOCs and radon.	6-20
6-18.	Comparison of temporal trends at north and south basement sampling locations.	6-21
6-19.	Autocorrelation function for chloroform, PCE, and radon by location (site and north/south basement).	6-23
7-1.	Subslab (or 9-ft soil gas) to indoor air AFs for individual sample locations, with the number of calculated AFs in each case indicated by the number directly below each whisker.	7-2
7-2.	Subslab to indoor air attenuation factors, calculated for each side of the duplex using only subslab points.	7-4
7-3.	Range of weekly chloroform and PCE concentrations in indoor air, subslab, and 9-ft interior soil gas samples over study period, with the number of calculated AFs in each case indicated below the whiskers.	7-5
7-4.	Attenuation factors vs. time: calculated for each side of the duplex using subslab soil gas ports and the shallowest of the nested interior soil gas ports.	7-7
8-1.	Box and whisker plots of chloroform distribution in soil gas at varying depths (concentration is log scale).	8-2
8-2.	Box and whisker plots of PCE distribution at various depths.	8-3
8-3.	Box and whisker plots of TCE distribution at various depths.	8-4
8-4.	Box and whisker plots of radon concentration at various depths.	8-5
9-1.	Kernal densities of % <i>Bias</i> for important VOCs.	9-4
9-2.	The effect of vapor pressure on sorbent performance.	9-5
10-1.	422 subslab vs. basement differential pressure (positive values indicate greater pressurization of the subslab and thus flow toward the basement).	10-4
10-2.	Basement vs. upstairs differential pressure (positive values indicate pressurization of the basement relative to the upstairs).	10-5
10-3.	Deep vs. shallow soil gas differential pressure beneath 422 East 28th Street (positive values indicate a greater pressure in the deep soil gas relative to the shallow soil gas).	10-5
10-4.	Basement vs. exterior (above grade) differential pressure at 422 East 28th Street (positive values indicate that the basement pressure is higher than the pressure in exterior air).	10-6
10-5.	Subslab vs. basement differential pressure at 420 East 28th Street (positive values indicate higher pressure in subslab than in the basement, thus flow toward the basement).	10-7
10-6.	Exterior barometric pressure measurements over time, 420/422 East 28th Street.	10-7
10-7.	Stack effect driving force for 422 East 28th Street over time.	10-9
10-8.	Stack effect driving force 420 (unheated) side over time.	10-9
10-9.	Summer and fall interior and ambient temperatures.	10-10

10-10. PCE concentrations in indoor air vs. stack effect driving force (log scale of concentration).	10-11
10-11. Chloroform concentrations in indoor air vs. stack effect driving force (log scale of concentration).	10-11
10-12. Radon concentrations (electret measurements) in indoor air vs. stack effect driving force.	10-12
10-13. Differential pressure measurements graphed with HVAC system on/off cycles; HVAC system status at times when basement vs. exterior differential pressure was observed is annotated.	10-14
10-14. Selected period of indoor and ambient temperature data, green arrow marks December 18 to December 23 HVAC system outage.	10-14
10-15. Selected period of indoor and ambient temperature data, green arrow shows March 11 to March 16 period of HVAC outage.	10-15
10-16. PCE, online GC data, 422 side, larger data points used to mark periods of heating system failure.	10-15
10-17. Average depth to water at house, discharge of nearby creek (USGS) and rainfall at house compared (intensive sampling rounds shown with vertical lines).	10-18
10-18. Storm and sanitary sewers near the test duplex at 420/422 East 28th Street.	10-19
10-19. Floor drain in first floor laundry room on 422 side of duplex.	10-20
11-1. Stacked graph presenting depth to water in feet (top—red circles), discharge at Fall Creek in ft ³ /s (middle—blue line), and rainfall in inches (bottom—green line).	11-2
11-2. Monitoring well water data for PCE versus time.	11-6
11-3. Flooded SGP water data for PCE versus time.	11-7
11-4. Soil moisture: irrometer moisture data in centibars for the interior and exterior of the 422/420 house.	11-10
11-5. Lithological fence diagram showing some of the major soil types beneath the 422/420 house.	11-10
11-6. Lithological fence diagram showing some of the major soil types beneath the 422/420 house.	11-11
11-7. PCE concentrations at each of the SGP1 ports over time.	11-12
11-8. PCE concentrations at each of the SGP2 ports vs. time.	11-12
11-9. PCE concentrations at each of the SGP5 ports over time.	11-13
11-10. PCE concentrations at each of the SGP6 ports over time.	11-13
11-11. PCE concentrations at SGP8 and SGP9 ports over time.	11-14
11-12. Temporal plot of log indoor air concentration for VOCs ($\mu\text{g}/\text{m}^3$) and radon (pCi/L) by sample location over the study period.	11-16
12-1. Fan test matrix.	12-4
12-2. Fan position in stairwell (note plastic sheet over doorway).	12-4
12-3. Differential pressure before, during, and after fan tests (fan tests denoted by vertical bars).	12-5
12-4. Radon on second floor before, during and after fan tests (fan tests denoted by vertical bars).	12-6
12-5. VOC Field instrument data before, during, and after fan tests (fan tests denoted by vertical bars).	12-7
12-6. Note height of basement window and vent (sealed for this study).	12-8
12-7. Subslab and soil gas VOC data during fan test period.	12-9
12-8. VOC data before, during, and after fan testing, Method TO-15.	12-10
12-9. Comparison of fan test responses of radon, PCE, and chloroform in 422 basement.	12-11
12-10. Comparison of electret and Safety Siren results.	12-13

List of Tables

2-1.	VOC Indoor Air Sampling Method Options.....	2-13
2-2.	Factors Causing Temporal Change in Vapor Intrusion and How They Are Observed and Measured.....	2-15
2-3.	Data Quality Objectives and Criteria.....	2-17
3-1.	Preliminary Indoor Air VOC Screening Results—Fan Off, Basement	3-10
3-2.	Preliminary Indoor Air Radon Screening—Fan Off, Basement	3-12
3-3.	VOC Results ($\mu\text{g}/\text{m}^3$) for Subslab and Soil Gas at 422 E. 28th St., Indianapolis—Fan Off	3-12
3-4.	VOCs ($\mu\text{g}/\text{m}^3$) in Indoor Air and Subslab Soil Gas, 420 & 422 E. 28th St., Indianapolis—Fan On.....	3-12
3-5.	Radon (pCi/L) in Indoor Air & Subslab Gas at 420 & 422 E. 28th St. Indianapolis— Fan Off and On	3-12
3-6.	Groundwater Screening Data	3-13
3-7.	Soil Analysis from MW-1 Boring at Multiple Depths.....	3-13
4-1.	Indoor Air Passive Field Blank Summary—Radiello 130.....	4-1
4-2.	Indoor Air Passive Trip Blank Summary—Radiello 130	4-2
4-3.	Indoor Air Passive Laboratory Blank Summary—Radiello 130	4-2
4-4.	Indoor Air Passive Surrogate Summary—Radiello 130	4-3
4-5.	Indoor Air Passive LCS Summary—Radiello 130	4-3
4-6.	Indoor Air Passive Laboratory Precision (LCS/LCSD) Summary—Radiello 130.....	4-4
4-7.	Subslab and Soil Gas—EPA Field Blank Summary—TO-17	4-5
4-8.	Subslab and Soil Gas—EPA Trip Blank Summary—TO-17	4-6
4-9.	Subslab and Soil Gas—EPA Laboratory Blank Summary—TO-17.....	4-6
4-10.	Subslab and Soil Gas—EPA Fridge Blank Summary—TO-17	4-7
4-11.	EPA TO-17 Surrogate Recovery Summary	4-7
4-12.	EPA TO-17 LCS Summary	4-8
4-13.	Subslab and Soil Gas—ATL Field Blank Summary—TO-17	4-9
4-14.	Subslab and Soil Gas—ATL Trip Blank Summary—TO-17	4-10
4-15.	Subslab and Soil Gas—ATL Lab Blank Summary—TO-17.....	4-10
4-16.	ATL TO-17 Surrogate Recovery Summary.....	4-11
4-17.	ATL TO-17 LCS Summary	4-11
4-18.	ATL TO-17 Laboratory Precision (LCS/LCSD) Summary.....	4-12
4-19.	Subslab and Indoor Air—ATL Lab Blank Summary—TO-15.....	4-13
4-20.	ATL TO-15 Surrogate Recovery Summary.....	4-13
4-21.	ATL TO-15 LCS Summary	4-14
4-22.	ATL TO-15 Laboratory Precision (LCS/LCSD) Summary.....	4-14
4-23.	Interlaboratory Results: Spiked Verification Samples.....	4-17
4-24.	Interlaboratory Statistics: Spiked Verification Samples	4-18
4-25.	Comparison of Online GC to Radiello Results.....	4-19
4-26.	Comparison between Electrets and Charcoal Canisters at the 422/420 EPA House from January 19–26, 2011	4-26
4-27.	Comparison of Electret and Charcoal Canister Data from April 27, 2011, to May 4, 2011	4-26
4-28.	Comparison of Charcoal and Electret Radon December 28, 2011, to January 4, 2012	4-27
4-29.	Comparison between 422 Base N Alphaguards and Electrets from March 30, 2011, and May 18, 2011	4-28
4-30.	Comparison of Real-Time Alphaguard to Integrated Electret August through October	4-28
4-31.	Comparison of Real-time Alphaguards to Integrated Electret Measurements December 28, 2011 to January 4, 2012	4-29

4-32.	Comparison of Real-Time Alphaguard to Integrated Electret Measurements January through March.....	4-30
5-1.	Frequency of Nondetects (%) by Soil Gas Point or Cluster.....	5-9
5-2.	Frequency of Nondetects by Depth and Compound	5-9
5-3.	Summary Meteorological Data for Central Indiana.....	5-53
6-1.	Counts of Records with Flag by VOCs and Flag Type for Soil Gas	6-1
6-2.	Counts of Records with Flag by VOCs and Flag Type for Indoor Air	6-2
6-3.	Comparison of Mean and Median Concentrations in North and South Sampling Locations, 422 Side of Duplex.....	6-22
9-1.	Summary Statistics for % <i>Bias</i> by Comparison Period and VOC	9-3
9-2.	Summary Statistics Individual Concentration Measurements by VOC and Period.....	9-6
9-3.	Summary Statistics for % <i>Bias</i> Comparing Daily vs. Weekly Period and VOC	9-7
9-4.	Evaluation of Daily vs. Weekly Differences	9-8
9-5.	Evaluation of Weekly vs. Biweekly Differences (Outlier Included)	9-9
9-6.	Evaluation of Weekly vs. Biweekly Differences (Outlier Removed).....	9-9
9-7.	Evaluation of Weekly vs. Monthly Differences.....	9-10
9-8.	Evaluation of Weekly vs. Quarterly Differences	9-10
9-9.	Evaluation of Weekly vs. Semiannual Differences	9-11
9-10.	Evaluation of Weekly vs. Annual Differences.....	9-11
9-11.	Average % <i>Bias</i> for Average Weekly Radiello Measurements Compared with Semiannual and Annual Modified SKC 575 Charcoal Badges	9-12
10-1.	April/May 2011 Air Exchange Rate Measurement Results.....	10-1
10-2.	September 2011 Air Exchange Rate Measurement Results.....	10-2
10-3.	National Survey of Air Exchange Rates, Reprinted from the <i>EPA Exposure Factor Handbook</i> (U.S. EPA, 2011).....	10-2
10-4.	Drain Sampling Data April 13–April 21, 2011 ($\mu\text{g}/\text{m}^3$)	10-21
10-5.	<i>NY Times</i> Database Report on Indianapolis Drinking Water Showing Relative Concentrations of PCE and Chloroform	10-21
11-1.	External Soil Gas Locations and Their Flooded Status during Different Times	11-3
11-2.	Internal Soil Gas Locations and Their Flooded Status during Different Times.....	11-4
11-3.	Groundwater Monitoring Well Information.	11-5
12-1.	Quality Objectives and Criteria for Special Studies	12-2
12-2.	Comparison of Safety Siren, Alphaguard, and Electret Data.....	12-13

Notice

The information in this document has been funded wholly by the United States Environmental Protection Agency under contract number EP-C-11-036 to the Research Triangle Institute. It has been subjected to the Agency's peer and administrative review and has been approved for publication as an EPA document. Mention of trade names or commercial products does not constitute endorsement or recommendation for use.

Acknowledgments

This project was conceived, directed, and managed by Brian Schumacher and John Zimmerman of US EPA NERL. Robert Truesdale (RTI International) and Chris Lutes (ARCADIS) led the project, with report input by Brian Cosky (ARCADIS), Breda Munoz and Robert Norberg (RTI), Heidi Hayes (Air Toxics Ltd.), and Blayne Hartman (Hartman Environmental Geoscience). The authors would also like to thank the following for their valuable input to the project:

- Leigh Riley Evens, Executive Director, Jackie Nytes, Former Executive Director, and Nate Lichti, Assistant Director, Mapleton-Fall Creek Development Corporation, who loaned the house used for this work.
- Dale Greenwell EPA NRMRL and Ron Mosley (retired), radon and equipment support
- Gregory Budd, US EPA Radiation and Indoor Environments National Laboratory, radon QC sample analysis and instrument support
- Ausha Scott, analytical support, Air Toxics Ltd.
- Alan Williams and Jade Morgan, U.S. EPA NERL, TO-17 analytical support
- Robert Uppencamp ARCADIS – field, data interpretation, and site selection support; Sara Jonker, ARCADIS, field support
- Rebecca Forbort and Valerie Kull, ARCADIS, Shu-yi Lin, RTI, data management and analysis
- Scott Forsberg, Harvard School of Public Health, air exchange rate measurement support
- Susan Beck and Sharon Barrell, RTI, document preparation and editing support.

Table of Contents

1. Executive Summary 1-1

 1.1 Background..... 1-1

 1.2 Purpose and Objectives 1-1

 1.3 Conclusions 1-2

 1.3.1 Seasonal Variation and Influence of HVAC 1-2

 1.3.2 Relationship Between Subsurface and Indoor Air Concentrations 1-3

 1.4.3 Relationship Between Radon and VOCs..... 1-3

 1.3.4 Conclusions: The Use of External Soil Gas Samples as a Surrogate Sampling
 Location..... 1-3

 1.3.5 Conclusions: The Duration Over Which Passive Samplers (Solvent Extracted
 Radial Style Charcoal) Provided Useful Integration of Indoor Air
 Concentrations..... 1-4

 1.3.6 Conclusions: Groundwater vs. Vadose Zone Sources as Controls on Indoor
 Concentrations at This Site..... 1-4

1. Executive Summary

1.1 Background

Vapor intrusion is the migration of subsurface vapors, including radon and volatile organic compounds (VOCs), from the subsurface to indoor air. Vapor intrusion has emerged as a priority VOC exposure pathway at many hazardous waste sites nationwide. Vapor intrusion occurs because of the pressure and concentration differentials between indoor air and soil gas. Indoor environments are often negatively pressurized with respect to outdoor air and soil gas, and this pressure difference allows soil gas with subsurface vapors to flow into indoor air through advection. In addition, concentration differentials may cause VOCs to migrate from areas of higher to lower concentrations through diffusion, which also causes vapor intrusion.

The vapor intrusion exposure pathway extends from the contaminant source, which can be free product or contaminated groundwater, to indoor air exposure points. Contaminated matrices therefore may include groundwater, soil, soil gas, and indoor air. VOC contaminants of concern typically include halogenated solvents such as trichloroethene (TCE), tetrachloroethene (PCE), and chloroform, and degradation products of TCE and PCE including dichloroethenes and vinyl chloride. Petroleum hydrocarbons, such as the aromatic VOCs benzene, toluene, and xylenes, can also cause vapor intrusion. Radon is a colorless radioactive gas that is released by radioactive decay of radionuclides in soil, where it migrates into homes through vapor intrusion in a similar fashion to VOCs. This project will focus on the vapor intrusion of halogenated VOCs, which are relatively recalcitrant (resistant) to biodegradation in aerobic soils and groundwater, and radon, which has a radioactive half-life of about 3.8 days.

1.2 Purpose and Objectives

The main purpose of this work assignment is to better characterize the spatial and temporal variability of vapor intrusion by collecting a full year's dataset of weekly measurements of subslab soil gas, external soil gas, and indoor air, on a single house that is impacted by vapor intrusion of radon and VOCs. By examining both short-term and long-term (average annual) concentrations, the project will provide valuable information on how to best take and evaluate measurements to estimate long-term, chronic risk for VOCs. We also studied the relationship between radon and VOC vapor intrusion in a house affected by both. The radon literature could provide valuable lessons for VOC vapor intrusion if there is a relationship, and radon, being much cheaper to measure than VOCs, could be an important tool in improving the investigation and mitigation of VOC vapor intrusion. Finally, we investigated the long-term performance of modified sorbent-based measurement techniques for time-integrated measurements of indoor air VOCs.

The project investigated distributional changes in VOC and radon concentrations in the indoor air, subslab, and subsurface soil gas from an underground source (groundwater source and/or vadose zone source) adjacent to a residence or small commercial building. The time frame of this study is 2 years in order to evaluate the effects due to seasonal variations on radon and VOC vapor intrusion.

There were four primary objectives for this research effort:

1. Identify any seasonal fluxes in radon and VOC concentrations as they relate to a typical use of HVAC in the building.
2. Establish relationship between subslab/subsurface soil gas and indoor air concentrations of VOCs and possibly radon.
3. Determine relationship of radon to VOC concentrations at a given site.

4. Examine if near-building external samples could be used as a surrogate sampling location.

Five secondary objectives were also addressed by the study:

1. Evaluate the duration over which solvent-extracted passive samplers provide useful integration of indoor air concentrations (i.e., over what duration is the uptake rate constant?).
2. Characterize the near-building environment sufficiently to explain the observed variation of VOCs and radon in indoor air.
3. Determine whether the observed changes in indoor air concentration of volatile organics of interest can be mechanistically attributed to changes in vapor intrusion.
4. Confirm that the two analytical laboratories (Air Toxics and U.S. Environmental Protection Agency [EPA]) can produce soil gas VOC data with sufficient agreement, that the variance between laboratories is not significant compared with the variance within laboratories or the changes in the underlying phenomena being observed.
5. Evaluate the extent to which groundwater concentrations and/or vadose zone sources control soil gas and indoor air VOC concentrations at this site.

Characteristics of the experimental design and data quality objectives (DQOs) developed to meet these objectives are provided in Section 2 of this document.

1.3 Conclusions

The conclusions of this study represent the fruit of an intensive study of a single early 20th century duplex in a particular geological setting—glaciofluvial deposits in Indianapolis, IN. Few other VOC vapor intrusion studies have collected a dataset of comparable detail, and those have been conducted in buildings of significantly different age or geological context.¹

1.3.1 Seasonal Variation and Influence of HVAC

- Lower VOC concentrations were observed in indoor air in summer. These VOC concentrations in indoor air are controlled not only by “building envelope-specific” factors, but they are also significantly influenced by seasonal variations in subsurface concentration distributions, especially in shallow/subslab soil gas where a weaker seasonal trend was observed.
- In indoor air, peak concentrations were seen in different months of the 2011 winter for PCE (January) and chloroform (March) on the first floor of this duplex. Temporal trends for chloroform and PCE differed markedly in fall 2011/winter 2012 between the heated and unheated sides of the duplex: the unheated side showed a much steeper decline in spring than the heated side. Thus, complex data patterns for multiple VOCs in the same structure can be expected even in the absence of occupant-related sources or activities.
- Stack-effect driving force calculations based on measurements of indoor/outdoor temperature differential were predictive of indoor air concentrations. These stack effects included not only the winter stack effect but also solar stack effects observed during summer and early fall. The cooling effect of window air conditioners appeared to provide some protection against vapor intrusion, at least for radon, during the summer months.

¹ Johnson, Op. Cit. also numerous case studies compiled in U.S. EPA (2012c).

- A repeatable seasonal effect of higher concentrations during winter was seen for chloroform and radon, but not all winters are equal. Winter 2011 and winter 2012 were very different climactically, and peak PCE concentrations observed in January 2011 were not equaled in 2012. Inter-year climatic variations are well known even by lay stakeholders, but their role in vapor intrusion studies may be underappreciated.

1.3.2 Relationship Between Subsurface and Indoor Air Concentrations

- PCE, chloroform, and radon have different spatial patterns in soil gas at this site.
- PCE and chloroform appear to have deep sources.
- Soil gas VOCs at some, but not all, high concentration sampling ports display a similar temporal pattern to that observed in indoor air, with higher concentrations during winter months.
- Sewer lines and laterals likely play some role in contaminant fate and transport in this system. Elevated concentrations of PCE and chloroform are present in the headspace of sewer gas. Their role in lateral transport through the vadose zone and into the subslab of the duplex will be elucidated through future geophysical studies.
- There is a strong seasonal component to the PCE and chloroform indoor concentrations (see Section 11). The seasonal component appears to be correlated to the strength of the stack effect, but it is not the only variable that controls indoor air concentrations.

1.4.3 Relationship Between Radon and VOCs

- Long-term (weekly and greater) radon concentrations in subslab air were more stable than VOC concentrations, presumably because the shallow soils themselves were the dominant source of radon and VOCs originate at a greater depth/distance.
- Radon concentrations in indoor air showed approximately an order of magnitude short term (< 1 day) variation—greater short-term variation than was observed for VOCs.
- The 1-week integration time dataset for radon had less seasonal variability than VOCs in indoor air.
- Statistical cross-correlation testing found that radon and VOCs were positively cross-correlated at several indoor air sampling locations (5% critical level). In laymen’s terms, we are quite confident that when radon concentrations go up, VOC concentrations will also go up in indoor air. Some cross-correlations of radon and VOCs were observed at soil gas ports, but these cross-correlations were less consistent/strong.
- Radon provided a qualitative indication that soil gas was entering this house. Thus, radon would have been a useful aid to VOC data interpretation if the house had been occupied and had numerous potential indoor sources. However, long-term radon exposure would not have completely predicted VOC exposure in this house over all time scales.

1.3.4 Conclusions: The Use of External Soil Gas Samples as a Surrogate Sampling Location

- High concentrations of VOCs and radon were seen in tight loams directly under building (subslab ports and 6-ft soil gas ports) but not in external soil gas above the level of the basement floor (3.5 ft bls).
- External soil gas samples collected at 6 ft bls, the depth of the basement floor, had substantial VOC concentration variability and would have underpredicted subslab concentrations.
- In deep soil gas (13 and 16.5 ft), there was close agreement between the mean chloroform and radon concentrations at points underneath the building and outside of the building. In deep soil

gas, PCE concentrations appeared lower on average and more variable for the points outside of the building than for the points beneath the building.

1.3.5 Conclusions: The Duration Over Which Passive Samplers (Solvent Extracted Radial Style Charcoal) Provided Useful Integration of Indoor Air Concentrations

- Excellent agreement was observed between numerical averages of successive 7-day exposure samples with the results of single passive samplers exposed for 14 days (almost always within $\pm 30\%$) for all compounds, despite dramatic temporal variability. This suggests uniform uptake rates for these time periods.
- The PCE, benzene, hexane, and toluene passive samplers tested provide good integration over durations from 7 to 28 days. Chloroform integration was less effective for durations greater than 2 weeks.
- The PCE and toluene passive samplers provide good integration of concentrations over durations from 7 to 364 days.
- Temporal variability in 1-week duration indoor VOC samples over the course of a year of $>20\times$ were observed. For certain less-volatile compounds, passive samplers allow cost-effective acquisition of long-term average concentration data.
- Vapor pressure predicted well the relative durations over which different compounds could be collected with the passive samplers.

1.3.6 Conclusions: Groundwater vs. Vadose Zone Sources as Controls on Indoor Concentrations at This Site

- The potentiometric surface at this house responds within days to rain events.
- Chloroform concentration trends visually correlate with hydrogeological changes.
- Chloroform concentrations in soil gas peak have their highest concentrations just above the water table.
- Chloroform is present in highest concentration in deep soil gas. Substantial chloroform has been historically detected in groundwater on a site 200 ft to the southwest. Chloroform was also detected in groundwater at this house in preliminary sampling. Further studies are planned to determine if the lack of detections in recent groundwater samples on site indicate migration through deep soil gas from off-site sources or losses in the sampling and analysis process. Chloroform attenuation is substantial between the area just above the water table and the 6-ft-depth below the structure. Chloroform is also substantially attenuated between subslab air and indoor air.
- PCE is apparently widely spatially distributed in site groundwater at concentrations well below the current $5\ \mu\text{g/L}$ MCL.² The calculated volatilization from these shallow groundwater concentrations matches observed deep soil gas concentrations. Only a moderate degree of attenuation occurs in those deep soil concentrations as they are drawn toward the basement of the structure. Substantial attenuation occurs in the upper 6 ft of the site external soil gas, which is composed of finer grained materials than the soils. Substantial attenuation also occurs across the building envelope between subslab and indoor air.
- The relative importance of the potential sources of PCE and chloroform—historic drycleaners, the adjacent commercial/industrial quadraplex, and storm sewers/drinking water disinfection—is unclear.

² <http://water.epa.gov/drink/contaminants/index.cfm>

Table of Contents

2. Introduction2-1

2.1 Background.....2-2

2.1.1 Variability in Vapor Intrusion Studies2-3

2.1.2 Vapor Attenuation Factors2-7

2.1.3 Potential for Use of Radon as a Vapor Intrusion Tracer2-8

2.1.4 Passive VOC Sampling2-10

2.2 Objectives.....2-14

2.2.1 Time Scale and Measurement of Independent and Dependent Variables2-15

2.2.2 Data Quality Objectives and Criteria2-16

List of Figures

2-1. An overview of important vapor intrusion pathways (U.S. EPA, 2002a).....2-2

2-2. Soil gas and groundwater concentrations below a slab (Schumacher et al., 2010).....2-6

List of Tables

2-1. VOC Indoor Air Sampling Method Options.....2-13

2-2. Factors Causing Temporal Change in Vapor Intrusion and How They Are Observed and Measured.....2-15

2-3. Data Quality Objectives and Criteria.....2-17

2. Introduction

Vapor intrusion is the migration of subsurface vapors, including radon and volatile organic compounds (VOCs), from the subsurface to indoor air. Vapor intrusion has emerged as a priority VOC exposure pathway at many hazardous waste sites nationwide. Vapor intrusion occurs due to the pressure and concentration differentials between indoor air and soil gas. Indoor environments are often negatively pressurized with respect to outdoor air and soil gas, and this pressure difference allows soil gas with subsurface vapors to flow into indoor air through advection. In addition, concentration differentials may cause VOCs to migrate from areas of higher to lower concentrations through diffusion, which also causes vapor intrusion.

The vapor intrusion exposure pathway extends from the contaminant source, which can be free product or contaminated groundwater, to indoor air exposure points. Contaminated matrices, therefore, may include groundwater, soil, soil gas, and indoor air. VOC contaminants of concern typically include halogenated solvents such as trichloroethene (TCE), tetrachloroethylene (PCE), and chloroform, and degradation products of TCE and PCE, including dichloroethylenes and vinyl chloride. Petroleum hydrocarbons, such as the aromatic VOCs benzene, toluene, and xylenes, can also cause vapor intrusion. These contaminants can be present in the vapor phase, dissolved phase, as a free phase (nonaqueous phase liquid or NAPL), or in a sorbed phase on soil or aquifer materials. Vapor intrusion of halogenated VOCs has been identified as an important exposure pathway at many contaminated sites, including Comprehensive Environmental Response, Compensation, and Liability Act (CERCLA), Resource Conservation and Recovery Act (RCRA), and Brownfield sites. Vapor intrusion also has occurred at leaking petroleum underground storage tank (UST) sites but is less prevalent because petroleum hydrocarbons are biodegradable.

Radon is a colorless radioactive gas that is released by radioactive decay of radionuclides in soil. Radon can migrate into homes through the vapor intrusion pathway in a similar fashion to VOCs. Radon is high in areas where the radioactive precursors to radon occur at relatively high concentrations in soil (as with the subject house of this investigation) and affects many more homes across the United States than halogenated VOCs. Low-cost testing and effective mitigation methods are available for radon, and the pathway has been studied extensively by EPA and other organizations.

This project focused on halogenated VOCs, which are relatively recalcitrant (resistant) to biodegradation in aerobic soils and groundwater, and radon, which has a radioactive half-life of about 3.8 days. Of the predominant two VOCs found in this house (chloroform and PCE), PCE is generally considered quite recalcitrant, with an aerobic half-life in groundwater of 1 to 2 years (Howard et al., 1991). Studies of chloroform biodegradation under aerobic conditions are mixed, with some showing recalcitrance (e.g., a 0.2 to 5-year half-life in Howard et al., 1991) and others showing moderate cometabolic biodegradation with methylene chloride and chloromethane as sequential degradation products (AFCEE, 2004; ATSDR, 1997).

Current practice for evaluating the vapor intrusion pathway involves a combination of mathematical modeling and direct measurements in groundwater, external soil gas, subslab soil gas, and indoor air. No single line of evidence is considered definitive, and direct measurements can be costly, especially where significant spatial and temporal variability require repeated measurements at multiple locations to accurately assess the chronic risks of long-term VOC exposure. The main focus of this work assignment is to better characterize this variability by collecting a full year's dataset of weekly measurements of subslab soil gas, external soil gas, and indoor air, on a single building that is impacted by vapor intrusion of radon and VOCs. By examining both short-term and long-term (average annual) concentrations, the project provides valuable information on how to best take and evaluate measurements to estimate long-term, chronic risk for VOCs. We further elucidate the relationship between radon and VOC vapor

intrusion in a house affected by both. The radon literature could provide valuable lessons for VOC vapor intrusion if there is a relationship, and radon, being much cheaper to measure than VOCs, could be an important tool in improving the investigation and mitigation of VOC vapor intrusion.

2.1 Background

An overview of the VOC vapor intrusion pathway is shown in **Figure 2-1**; the building in which exposure occurs is shown in the center. Three main routes of VOC migration have been defined:

1. Movement of VOC vapors from shallow soil sources through the unsaturated (vadose) zone
2. Transport of VOCs through groundwater, followed by partitioning of VOCs from the most shallow layer of groundwater into vadose zone soil gas
3. Vapor movement through preferential pathways such as utility corridors

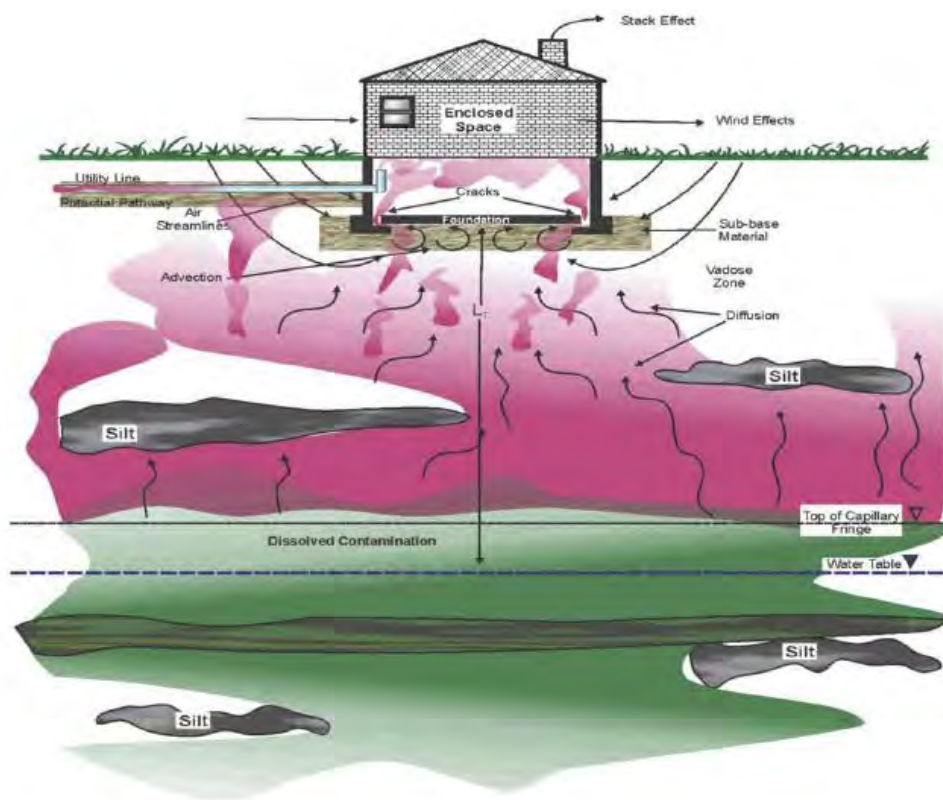

Figure 2-1. An overview of important vapor intrusion pathways (U.S. EPA, 2002a).

In portions of these three routes, advective forces predominate and in others diffusive forces dominate transport.

The final step of vapor intrusion typically involves soil gas moving from immediately below the building slab into the indoor air. This subslab space is often significantly more permeable than the bulk vadose zone soil, either because a gravel drainage layer was intentionally used or the soils have shrunk back from the slab in places. In those cases, the subslab space is expected to serve as a common plenum allowing the lateral mixing of VOCs that reach the building through multiple pathways. In other cases, the subslab space may not be so interconnected, resulting in differing subslab VOC concentrations at different locations across the slab.

Vapor and liquid transport processes and their interactions with various geologic and physical site settings (including building construction and design), under given meteorological conditions, control migration through the vapor intrusion pathway. Variations in building design; construction, use, and maintenance; site-specific stratigraphy; subslab composition; temporal variation in atmospheric pressure; temperature; precipitation; infiltration; soil moisture; water table elevation; and other factors combine to create a complex and dynamic system. Important factors controlling vapor intrusion at many sites include (NJ DEP, 2005):

- Biodegradation of VOCs as they migrate in the vadose zone,
- Site stratigraphy,
- Soil moisture and groundwater recharge,
- Fluctuations in water table elevation, and
- Temporal and inter-building variations in the operation of ventilation systems in commercial/industrial buildings.

The U.S. Environmental Protection Agency (U.S. EPA) Office of Research and Development (ORD) has developed a subslab sampling protocol (U.S. EPA, 2005a). The available information to date indicates that properly placed subslab sampling can significantly increase the reliability of vapor intrusion estimates and environmental decisions. One important reason is that assessment of subslab VOCs allows the investigator to forensically determine the contributions to indoor air from the soil gas immediately underlying the slab. However, one disadvantage of subslab sampling is its intrusiveness to the occupants of the building. In addition, if a subslab probe is not properly installed, it could provide a preferential route for contaminant migration. Also, if the space beneath a slab is not interconnected and well mixed, individual samples may not give an accurate picture of VOC concentrations beneath the slab.

This project explored and further developed several promising cost-effective techniques to evaluate the vapor intrusion pathway and improve data quality. Two primary tools were investigated: (1) using modified sorbent-based measurement techniques for time-integrated measurements of indoor air VOCs and (2) using radon as a tracer for assessing VOC vapor intrusion. The project also investigated measurements of pressure differentials (subslab vs. indoor), meteorological conditions, crack size, and air exchange rates in the context of the chemical-specific measurements described above. These physical measurements are not stand-alone tools nor are they the emphases of the current research program, but are necessary supporting tools for developing a conceptual understanding of spatial variability, temporal seasonal effects, and a mass balance around a building subject to vapor intrusion.

2.1.1 Variability in Vapor Intrusion Studies

This project focuses on observing changes in vapor intrusion over a 2-year period. In order to express quantitatively our goals for this project, it is necessary to understand the causes and typical ranges of spatial and temporal variation in various matrices studied for vapor intrusion assessment.

Through measurements of radon and VOC vapor intrusion under various conditions, several studies have provided insight into the complexity of temporal variability in indoor air concentrations attributable to vapor intrusion—the primary focus of this work. Nazaroff et al. (1987) studied how induced-pressure variations can influence radon transport from soil into buildings with roughly hourly resolution. In a more recent study, Mosley (2007) presented the results of experiments, showing that induced building-pressure variations influence both the temporal and spatial variability of both radon and chlorinated VOCs in subslab samples and in indoor air (hourly sampling for radon). Schuver and Mosley (2009) have also reviewed numerous studies of radon indoor concentrations, in which multiple repeated indoor air samples were collected with hourly, daily, weekly, monthly, 3-month, and annual sample durations for study

periods of up to 3 years; however, soil gas datasets with such detailed measurements of both radon and VOCs are rare.

Several radon studies have demonstrated that barometric pressure fluctuations can affect the transport of soil gas into buildings (Robinson and Sextro, 1997; Robinson et al., 1997). The impact of barometric pressure fluctuations on indoor air is influenced by the interaction of the building structures and conditions, as well as other concurrent factors, such as wind (Luo et al., 2006, 2009). Changes in atmospheric conditions (e.g., pressure, wind) and building conditions (e.g., open doors and windows) may temporarily over- or under-pressurize a building. Based on long-term pressure differential datasets acquired by ARCADIS and EPA's National Risk Management Research Laboratory (NRMRL) at an Indianapolis study site at which both radon and VOCs are being measured in both subslab and indoor air, other factors that may cause temporal and spatial variability in soil vapor and indoor air concentrations include

- fluctuation in building air exchange rates due to resident behavior/HVAC operations,
- fluctuations in outdoor/indoor temperature difference, and
- rainfall events and resultant infiltration and fluctuations in the water table elevation.

The pressure difference between a house-sized building and the surrounding soil is usually most significant within 1 m to 2 m of the structure, but measurable effects have been reported up to 5 m from the structure (Nazaroff et al., 1987). Temperature differences or unbalanced mechanical ventilation are likely to induce a symmetrical pressure distribution in the subsurface, but the wind load on a building adds an asymmetrical component to the pressure and distribution of contaminants in soil gas.

Folkes et al. (2009) summarize several large groundwater, subslab, and indoor air datasets collected, with sampling frequencies ranging from quarterly to annually during investigations of vapor intrusion from chlorinated VOC plumes beneath hundreds of homes in Colorado and New York. They analyzed these datasets to illustrate the temporal and spatial distributions in the concentration of VOCs. In a study of the vapor intrusion pathway at the Raymark Superfund site, DiGiulio et al. (2006) showed that measured concentrations of chlorinated VOCs in subslab exhibited spatial and temporal variability between neighboring houses and within individual houses. Similar variability in subslab chlorinated VOC concentrations within and between houses has been observed during vapor intrusion evaluations of several sites in New York State (Wertz and Festa, 2007).

In scenarios with coarser soils (e.g., sands, gravels), the soil gas permeability is high, and changes in building pressurization may affect the airflow field and the resultant soil vapor concentration profiles near buildings. In scenarios with fine-grained soils (e.g., silts, clays), the soil gas permeability is low and soil gas flow rates (Q_s) may be negligible and not affect the subsurface concentration. Nevertheless, in both soil-type scenarios, over-pressurization of the building may still significantly reduce the indoor air concentration due to the reversal of soil gas flow direction from the building into the soil (Abreu and Johnson, 2005, 2006).

A wind-induced, non-uniform pressure distribution on the ground surface on either side of a house may cause spatial and temporal variability in the subslab soil vapor concentration distribution if the wind is strong and the soil gas permeability is high (Luo et al., 2006, 2009). In addition, during or after a rainfall event, the subsurface beneath the building may have a lower moisture content than the adjacent areas due to water infiltration.

Spatial Variability

Spatially, reports of several orders of magnitude variability without apparent patterns between indoor air and subslab concentrations for adjacent structures in a neighborhood are very common (see, for example, Dawson, 2008). Six orders of magnitude in subslab concentration variability were reported by Eklund and Burrows (2009) for one building of 8,290 sq ft. As shown in **Figure 2-2**, Schumacher and coworkers observed more than three orders of magnitude concentration variability in shallow soil gas below a slab over 50 lateral ft (Schumacher et al., 2010), suggesting a strong effect of impervious surfaces both in limiting soil gas exchange with the atmosphere and in maintaining relatively high concentrations of VOCs in shallow groundwater. Schumacher and others (2010) also observed two orders of magnitude concentration variability with a depth change of 10 ft in the unsaturated zone within one borehole. Lee and others (2010) observed two orders of magnitude variability in subslab concentration within a small townhouse. Studies by McHugh and others (2007) have generally found markedly less variability in indoor air concentrations than in subslab concentrations, probably due to the greater degree of mixing in the indoor environment.

Temporal Variability

Temporal variability has been summarized by ITRC (2007), which states in Section D.4.10:

Variations in soil gas concentrations due to temporal effects are principally due to temperature changes, precipitation, and activities within any overlying structure. Variations are greater in samples taken close to the surface and dampen with increasing depth. In 2006 there were a number of studies on temporal variation in soil gas concentrations, and more are under way or planned in 2007 by USEPA and independent groups. To date these studies have shown that short-term variations in soil gas concentrations at depths 4 feet or deeper are less than a factor of 2 and that seasonal variations in colder climates are less than a factor of 5 (Hartman 2006). Larger variations may be expected in areas of greater temperature variation and during heavy periods of precipitation, as described below.

IBM, Endicott, New York

Recent data from a large site in Endicott, New York, collected over a 15-month period showed soil gas concentration variations of less than a factor of 2 at depths greater than 5 ft bgs.

- *Temperature. Effects on soil gas concentrations due to actual changes in the vadose zone temperature are minimal. The bigger effect is due to changes in an overlying heating or HVAC system and the ventilation of the structure due to open doors and windows. In colder climates, worse-case scenarios are most likely in the winter season. The radon literature suggests that temporal variations in soil gas are typically less than a factor of 2 and that seasonal effects are less than a factor of 5. If soil gas values are more than a factor of 5 below acceptable levels, repeated sampling is likely not necessary regardless of the season. If the measured values are within a factor of 5 of allowable risk levels, then repeated sampling may be appropriate.*



Measured Soil Gas Profile for TCE – Phase 2

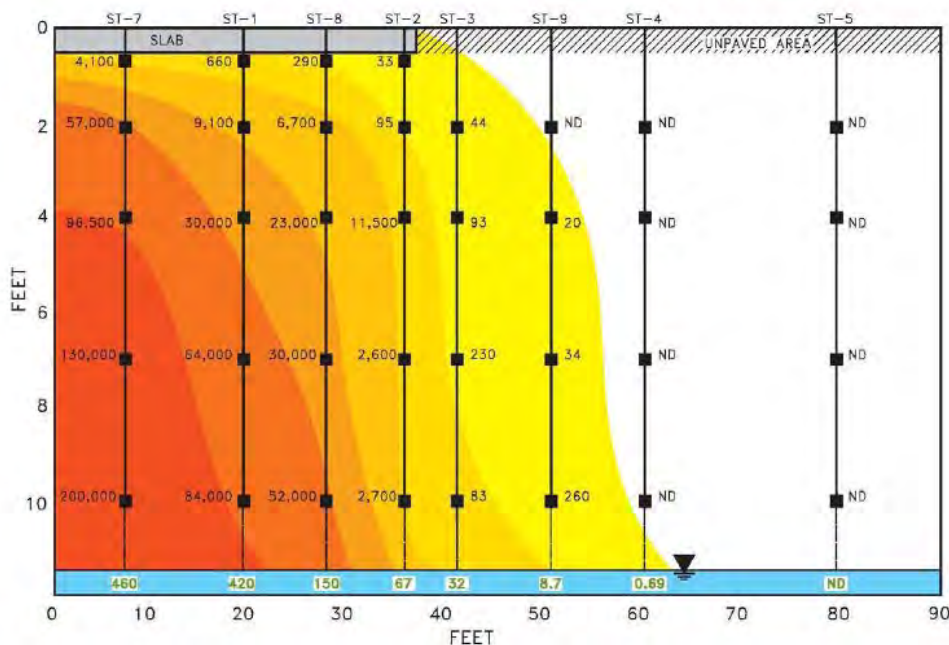

Figure 2-2. Soil gas and groundwater concentrations below a slab (Schumacher et al., 2010).

- Precipitation.** Infiltration from rainfall can potentially impact soil gas concentrations by displacing the soil gas, dissolving VOCs, and by creating a “cap” above the soil gas. In many settings, infiltration from large storms penetrates into only the uppermost vadose zone. In general, soil gas samples collected at depths greater than about 3–5 feet bgs or under foundations or areas with surface cover are unlikely to be significantly affected. Soil gas samples collected closer to the surface (<3 feet) with no surface cover may be affected. If the moisture has penetrated to the sampling zone, it typically can be recognized by difficulty in collecting soil gas samples. If high vacuum readings are encountered when collecting a sample or drops of moisture are evident in the sampling system or sample, measured values should be considered as minimum values.
- Barometric Pressure.** Barometric pressure variations are unlikely to have a significant effect on soil gas concentrations at depths exceeding 3–5 feet bgs unless a major storm front is passing by. A recent study in Wyoming (Luo et al. 2006) has shown little to no relationship between barometric pressure and soil gas oxygen concentrations for a site with a water table at ~15 feet bgs.

In summary, temporal variations in soil gas concentrations, even for northern climates, are minor compared with the conservative nature of the risk-based screening levels. If soil gas values are a factor of 5–10 times below the risk-based screening levels, there likely is no need to do repeated sampling unless a major change in conditions occurs at the site (e.g., elevated water table, significant seasonal change in rainfall).....

And in Section D.8 of the same document ITRC notes:

Short-term temporal variability in subsurface vapor intrusion occurs in response to changes in weather conditions (temperature, wind, barometric pressure, etc.), and the variability in indoor air samples generally decreases as the duration of the sample increases because the influences tend to average out over longer intervals. Published information on temporal variability in indoor air quality shows concentrations with a range of a factor of 2–5 for 24-hour samples (Kuehster, Folkes, and Wannamaker 2004; McAlary et al. 2002). If grab samples are used to assess indoor air quality, a factor of safety (at least a factor of 5) should be used to adjust for short-term fluctuations before comparing the results to risk-based target concentrations. Long-term integrated average samples (up to several days) are technically feasible, using a slower flow rate this is the USEPA recommended approach for radon monitoring). Indoor air sampling during unusual weather conditions should generally be avoided.

In Section D.11.8, ITRC goes on to discuss the effect of meteorological changes on vapor intrusion:

A variety of weather conditions can influence soil gas or indoor air concentrations. The radon literature suggests that temporal variations in the soil gas are typically less than a factor of 2 during a season and less than a factor of 5 from season to season). . . Forensic approaches were used at the Redfield Rifles site in Colorado to determine whether the source of subslab contaminants was in the vadose zone or the overlying structure (McHugh, De Blanc, and Pokluda 2006). D-28 Endicott, New York and Casper, Wyoming are in agreement with the radon results. For soil gas, the importance of these variables will be greater the closer the samples are to the surface and are unlikely to be important at depths greater than 3–5 feet below the surface or structure foundation.

Measurement Variability

Beyond spatial and temporal variability, the underlying uncertainty of the measurements used to assess vapor intrusion must also be considered. Many measurements of vapor intrusion, both in indoor air and subslab soil gas have traditionally relied on Summa canister samples analyzed by methods TO-14/TO-15 (U.S. EPA, 1996, 1999). Method TO-15 specifies an audit accuracy of 30% and a replicate precision of 25% as performance criteria. But even those figures do not fully convey the interlaboratory variability observed for these methods when applied to the low concentrations typical of indoor air studies. As Lutes and coworkers (2010) reported:

- *In two recent TO-15 or 8260 interlaboratory comparisons administered by the company ERA for gas phase samples the acceptance range for tetrachloroethylene results were:*
 - *4.31–22.3 ppbv (July–Sept 2009 study)*
 - *31.6–74.1 µg/L (October–November 2007 study)*
- *For comparison in a 2007 TO-14/TO-15 study conducted by Scott Specialty Gasses, the reported values for toluene reported by 12 labs varied from 3.1 to 18.6 ppb.*

2.1.2 Vapor Attenuation Factors

One common way of evaluating the impact of subsurface vapors on indoor air quality is to compute the ratio of indoor air concentration to subslab soil vapor concentration. EPA has defined the resulting “attenuation factor” as follows: “The attenuation factor, α , is a proportionality constant relating indoor air concentrations ($C_{\text{indoor air}}$) to the concentrations of vapors in soil gas ($C_{\text{soil gas}}$) or groundwater ($C_{\text{groundwater}}$) concentrations.” For soil gas to indoor air, the equation is as follows:

$$C_{\text{indoor air}} = \alpha_{\text{SG}} \times C_{\text{soil gas}} .$$

For groundwater, a similar equation is used, except that the dimensionless Henry's Law Constant (H) is used to convert the dissolved VOC concentration in groundwater to the corresponding equilibrium vapor concentration:

$$C_{\text{indoor air}} = \alpha_{\text{GW}} \times C_{\text{groundwater}} \times H.$$

A larger α indicates less attenuation and a smaller value indicates more attenuation. The greater the attenuation factor, the greater the indoor concentration.

Within any one given site, the attenuation factors

- between groundwater and indoor air typically vary 2 to 3 orders of magnitude and
- between external soil gas and indoor air typically vary 2 to 4 orders of magnitude.

Subslab soil gas and indoor air typically vary 2 to 4 orders of magnitude (Dawson and Schuver, 2010).

2.1.3 Potential for Use of Radon as a Vapor Intrusion Tracer

Radon, a naturally occurring radioactive gas, is a potentially useful surrogate for assessing VOC vapor intrusion because the physics of radon intrusion into indoor air is nearly identical to VOC vapor intrusion. Radon is ubiquitous in the soil and present at measurable quantities throughout the United States. Indeed, much of the research in VOC vapor intrusion is an expansion of earlier work on radon intrusion. It is less expensive to measure radon than VOCs, and the radon measurements could be a useful screening tool to target buildings for additional vapor intrusion assessment.

Radon provides a nearly unique tracer for vapor intrusion because its presence in the indoor environment is usually a result of radon in the soil gas immediately surrounding a building. In general, the entry mechanisms are believed to be the same for VOCs and radon in soil gas. Thus, measured radon entry rates should be a good predictor of relative entry rates for VOCs. The advantages of using radon as a tracer for vapor intrusion characterization include:

- Measurements of radon are easier, more accurate and precise, and much less expensive than canister measurements of VOCs (typically less than 10% of the VOC analysis cost). Passive indoor sampling for radon costs approximately \$5 to \$20 per sample. Active radon sampling (indoor air and subslab) uses some of the same equipment and setup as for VOCs. This minimizes sampling times and cost.
- High levels of indoor radon identify buildings as vulnerable to soil gas entry.
- Because of the low sampling/analytical costs, it is possible to increase the number of field measurements. This, in turn, increases confidence in the field evaluation.
- Because mitigation systems are the same for radon and VOCs, and because radon and VOCs behave similarly in the vicinity of the building, radon measurements before and after installation of vapor intrusion mitigation systems may be useful for assessing mitigation system performance for VOCs as well.

In summary, the limited data gathered to date suggest that radon measurement may be an inexpensive, reliable surrogate for VOC measurement when characterizing vapor intrusion and may significantly enhance vapor intrusion characterization and decision making, particularly when used in conjunction with subslab sampling. However, several key aspects and assumptions of this approach need to be verified before it can be put into widespread use.

For radon to be a valuable tracer:

- Radon detection in building interiors should be quantitatively possible across the wide range of subslab concentrations encountered in the United States. Ideally these measurements can be made with inexpensive passive methods (i.e., charcoal or electrets).
- Radon route and mechanism of entry should be similar to that of VOCs of interest, once both species are present in the subslab soil gas. This would imply that the subslab attenuation factors for radon and VOCs are similar.
- Variance in the natural vadose zone (unsaturated soil) radon concentration across a given building footprint should be low enough to allow radon to be a useful indicator.
- Concentrations of radon and the VOCs of concern should be well correlated in subslab soil gas. This would not necessarily be expected based on the fact that radon and VOCs have different sources. However, they may indeed be approximately correlated if the VOC(s) of interest and radon are both widely dispersed in deep soil gas. In this case, the concentrations of both radon and VOCs at various locations in the subslab may be controlled primarily by the ratio of flow from the deep soil gas to the flow from ambient air (in which both VOC and radon concentrations would be expected to be low).
- Interior sources of radon should be negligible.

The loss rates to sink effects in the indoor environment should be similar or negligible for radon and VOCs so that the air exchange rate forms the primary control on indoor air concentration once vapor intrusion has occurred.

To our knowledge, this concept was first applied in a relatively small study (Cody et al., 2003) at the Raymark Superfund Site in Connecticut. The study compared the intrusion behavior of radon and individual VOCs by determining attenuation factors between the subslab and indoor (basement) air in 11 houses. The results indicated that the use of radon measurements in the subslab and basement areas was promising as a conservative predictor of indoor VOC concentrations when the subslab VOC concentrations were known. Further work at the Raymark site (U.S. EPA, 2005b) statistically compared basement and subslab concentration ratios for radon and VOCs associated with vapor intrusion. Of six test locations, three showed that basement/subslab concentration ratios for radon and VOCs associated with subsurface contamination were similar. Three had statistically different ratios, suggesting that further research was needed to evaluate the usefulness of radon in evaluating vapor intrusion. Conservative VOCs (those believed to be associated only with subsurface contamination) were a better predictor of other individual volatile compounds associated with vapor intrusion than was radon.

A three-building complex, commercial case study of the radon tracer approach was published by Wisbeck et al. (2006). Radon and indoor air attenuation factors were calculated for five sampling points and were generally well correlated. Subslab radon concentrations varied by approximately a factor of 10 across the five sampling points.

Results of an earlier test program at Orion Park Housing units at Moffett Field have been preliminarily reported (Mosley, 2007). Results showed:

- Low levels of radon can be measured with sufficient accuracy to be used in analysis of vapor intrusion problems.
- Radon is a promising, low-cost surrogate for soil gas contaminants; however, as with VOCs themselves, the complete distribution under the slab must be known in order to properly interpret its impact on indoor measurements.

- Unexpectedly, the subslab areas under each unit were segmented. The four subslab sampling points installed in one unit were not in good communication with one another. An introduced tracer, SF₆, moved very slowly and not very uniformly under the slab.
- Results showed that for sites where subslab soil conditions lead to interrupted flow and poor communication beneath the slab, a subslab measurement at a single point is not very reliable for estimating potential vapor intrusion problems. The average value of subslab measurements at several locations also may not yield a reliable estimate of indoor concentrations. When subslab communication is poor, one must identify a connection between subslab contaminants and a viable entry path.

The potential usefulness of the radon tracer was studied in 2007–2010 by EPA NRMRL at Moffett Field in California and in the Wheeler building in Indianapolis. These studies are summarized in three draft peer-reviewed papers that have been submitted for EPA internal review:

- *Vapor Intrusion Evaluation Using Radon as a Naturally Occurring Tracer.* In this paper we compile data from five study sites where radon has been used in VOC vapor intrusion investigations and attenuation factors were calculated. A total of 17 buildings are included in the dataset, a mix of commercial and residential, in a wide variety of geographical areas within the United States. Some correlation between radon and VOC attenuation factors was seen, but it was not perfect.
- *Randomized Experiment on Radon Tracer Screening for Vapor Intrusion in a Renovated Historical Building Complex.* This study focused on a renovated former industrial facility now being reused as residential, public, and office space. Fifty locations within the complex were originally screened for radon using passive sampling techniques. Two subsets of these sample locations were selected for passive VOC sampling, one randomly and the other based on the radon information. The upstairs radon-guided samples were significantly higher in TCE than the randomly selected locations. The portions of the building complex where the radon guidance appeared to provide predictive power were understandable in terms of the building design and the concept of the open basement serving as a common plenum.
- *Case Study: Using Multiple Lines of Evidence to Distinguish Indoor and Vapor Intrusion Sources in a Historic Building :* This paper uses datasets developed at the Southeast Neighborhood Development Corporation (SEND) Wheeler Arts Building site in Indianapolis, Indiana, to demonstrate the use of multiple lines of evidence in distinguishing indoor from subsurface sources in a complex multiuse, multiunit building. The use of radon as a quantitative tracer for vapor intrusion source discrimination is shown as well as the use of differential pressure data as an additional line of evidence. Box and whisker plots of the distribution of indoor air pollutants on multiple floors are used to distinguish pollutants with predominant subslab sources from those with predominant indoor sources. Those pollutants, which the box and whisker analysis suggests have indoor sources, are also corroborated from the literature as having very common indoor sources expected in this building, including arts and crafts activities, human exhalation, consumer products, and tobacco smoking.

2.1.4 Passive VOC Sampling

Sorbent-based methods are an emerging technology for vapor intrusion assessment. Current standard practices for indoor air VOC monitoring in the United States include the use of ultra-clean, passivated, and evacuated (i.e., under a negative pressure) stainless steel canisters for sample collection. Practitioners frequently use 8- to 48-hour integrated samples with Summa canisters in an attempt to average over an exposure period. This is the U.S. “gold standard” for indoor air analysis, but it is expensive to implement. Professional experience, including that gathered under WA 4-46 but not yet published, shows that the

flow controllers currently used in commercial practice are subject to substantial flow rate and final pressure errors when set for integration times in excess of 24 hours (Hayes, 2008).

Active and passive sorbent sampling techniques are already in use in the United States for personal air monitoring for industrial workers and are outlined in both OSHA Sampling and Analytical Methods (<http://www.osha.gov/dts/sltc/methods/toc.html>) and NIOSH Manual of Analytical Methods (<http://www.cdc.gov/niosh/nmam/>). Typical sampling scenarios involve the collection of active or passive samples to monitor a single chemical used in the workplace over a period of up to 10 hours. These methods are designed to meet OSHA PELs, which are typically in the parts per million (ppm) range and consequently several orders of magnitude higher than risk-based indoor air screening levels and not suitable for ambient air measurements without modification.

Active sorbent methods (e.g., TO-17) have also been published by EPA for VOC measurements in ambient air (U.S. EPA, 1999). However, in those methods, air samples are normally actively collected over 1 hour, using a sample pump with a sampling rate of 16.7 mL/min to 66.7 mL/min, yielding total sample volumes between 1 and 4 L. Sampling intervals can be extended beyond 1 hour; however, care must be taken to ensure breakthrough volumes are not exceeded in order to quantitatively retain the compounds of interest on the sorbent tube. Given the minimum pump flow rate cited in TO-17 of 10 mL/min, the practical upper limit for chlorinated VOCs using a multi-bed thermal desorption sorbent tube is on the order of 10 L (Marotta et al., 2012) up to 20 L for select VOCs yielding a corresponding maximum collection period of 8 to 24 hours.

One way to lower the detection limits and control day-to-day variability is to sample over a longer period of time. Recent studies have shown that it may be feasible to use passive sorbent samplers to collect a continuous indoor air sample over several weeks. This approach would provide a lower detection limit, be cost-effective, and result in a time-integrated composite sample. Laboratory and field evaluations of such an approach for ambient and indoor air applications have been published and showed promising results for sampling durations of up to 14 days. Exposure of badge-type charcoal passive samplers to controlled atmospheres of 10 ppb to 200 ppb benzene, toluene, and m-xylene showed good performance when deployed for 14 days (Oury et al., 2006). A field study published by Begerow and others (1999) showed comparability between two charcoal-based passive sampler geometries, badge and tube-style for 4-week indoor and outdoor air samples. Field evaluations were also conducted using radial charcoal and thermal desorption Radiello® samplers to determine performance over a 14-day period. Ambient BTEX measurements using the Radiello samplers compared well to active sorbent sampling results (Cocheo et al., 2009).

During testing at Orion Park, Moffett Field in California by EPA NRMRL APPCD, EPA Region IX, and ARCADIS compared measurements of VOCs by Method TO-15 to three different sorbent systems:

1. Radial: Activated Charcoal (with CS₂ extraction: GC/MS)
2. Radial: Carbograph 4 (TO-17: Thermal Desorption [TD] GC/MS)
3. Axial: Chromosorb 106 thermal desorption tube (TO-17: TD GC/MS)

Testing was also performed at the Wheeler site in Indianapolis comparing Summa canisters to Radiello solvent-extracted samplers. Across the two sites, the Radiello solvent extracted showed good agreement to TO-15 and precision at both sites for chlorinated compounds. Agreement was poor for polar compounds: ethanol, MEK, MIBK, and acetone. Radiello thermal desorption correlated well with Summa TO-15 but gave noticeably lower concentrations, suggesting that 2 weeks is too long an integration time for these samplers. The agreement of the axial (tube) method was inferior (Mosley, 2008; Lutes, 2010).

Table 2-1 compares the characteristics of commercially available passive sampler geometries and available sorbent configurations. The geometry of the sampler (radial, badge, or tube) largely determines the sampling rate or uptake rate, with the radial design resulting in the highest sampling rate and the tube-style the lowest sampling rate. The permeation sampler relies on permeation of the vapor-phase compound through the polydimethylsiloxane (PDMS) membrane and adsorption to the sorbent bed behind the membrane. The greater the sampling rate, the greater the mass of VOCs adsorbed onto the sorbent bed. In addition to the passive geometries available, sorbent pairings fall into two main categories—charcoal based and thermally desorbable. Charcoal-based materials are characterized as very strong sorbents with a large surface area and a corresponding high adsorption capacity. To efficiently extract adsorbed compounds for measurement in the laboratory, an aggressive solvent extraction is required. The thermally desorbable sorbents are generally much weaker than charcoal with a smaller surface area, allowing for analysis of the adsorbed compounds through thermal extraction. As **Table 2-1** shows, when comparing the same passive geometry, the thermally desorbed model provides the lowest detection limits, while the charcoal-based solvent-extracted system allows for longer sampling times as well as a greater dynamic range because the high capacity of the charcoal minimizes sorbent saturation under conditions of high analyte or background matrix.

European agencies have developed standard methods for passive sampling for VOCs that are applicable to the range of concentrations and durations to be tested in this project:

- Methods for the Determination of Hazardous Substances (MDHS) 88: *Volatile Organic Compounds in Air: Laboratory Method Using Diffusive Samplers, Solvent Desorption and Gas Chromatography*, December 1997. Published by the Health and Safety Executive of the United Kingdom: <http://www.hse.gov.uk/index.htm>.
- Methods for the Determination of Hazardous Substances (MDHS) 80: *Volatile Organic Compounds in Air: Laboratory Method Using Diffusive Solid Sorbent Tubes, Thermal Desorption and Gas Chromatography*, August 1995. Published by the Health and Safety Executive of the United Kingdom: <http://www.hse.gov.uk/index.htm>
- Ambient air quality—Standard method for measurement of benzene concentrations – Part 4: Diffusive sampling followed by thermal desorption and gas chromatography, EN 14662-4:2005. Published by the European Committee for Standardization.
- Ambient air quality—Standard method for measurement of benzene concentrations – Part 5: Diffusive sampling followed by solvent desorption and gas chromatography, EN 14662-5:2005. Published by the European Committee for Standardization. (Also published as the British Standard BS EN 14662-5:2005)
- Indoor air quality—Diffusive samplers for the determination of concentrations of gases and vapors—Guide for selection, use, and maintenance, EN 14412:2004. Published by the European Committee for Standardization.

Given the wide range of sampling durations required for this project, several diffusive sampler configurations are recommended to meet anticipated project objectives for indoor air measurements. For short-term samples (less than 7 days), the sampler must have sufficient sensitivity to measure the low VOC concentrations that are expected in the indoor air. Thermally desorbable sorbents paired with a badge or radial-style geometry can effectively be used for the 24-hour samples and yield low reporting limits. The badge style is recommended over the radial style given the larger number of chlorinated compounds for which sampling rates have been generated and validated. For durations of greater than 7 days, stronger sorbents with higher adsorptive capacity are recommended, which require solvent extraction. Although the solvent extraction is less sensitive than thermal desorption, the high sampling rate of the radial sampler geometry over durations of 7 to 30 days will result in sample reporting limits essentially equivalent or lower than those generated using the thermal desorption technique.

Table 2-1. VOC Indoor Air Sampling Method Options

Parameter	Whole Air	Sorbent-Active	Sorbent-Diffusive						
			Radial: Charcoal (Radiello 130)	Radial: TD sorbent (Radiello 145)	Badge: Charcoal type (SKC 575, 3M OVM3500)	Badge: TD sorbents selected by deployment time: (SKC Ultra I, II, III)	Tube: TD sorbents (e.g., Chromosorb 106)	Permeation: Charcoal type (WMS™)	Permeation: TD sorbent (WMS™)
Collection media	Summa Canister (TO-15)	Multi-bed ATD sorbent tubes (TO-17)	Radial: Charcoal (Radiello 130)	Radial: TD sorbent (Radiello 145)	Badge: Charcoal type (SKC 575, 3M OVM3500)	Badge: TD sorbents selected by deployment time: (SKC Ultra I, II, III)	Tube: TD sorbents (e.g., Chromosorb 106)	Permeation: Charcoal type (WMS™)	Permeation: TD sorbent (WMS™)
Ease of deployment	Good	Good	Excellent	Excellent	Excellent	Excellent	Excellent	Excellent	Excellent
Media and shipping cost	high	medium	low	high	low	medium	medium	low	low
Method and analysis	TO-15 GC/MS	TO-17 GC/MS	Solvent Extraction GC/MS or GC/FID	TO-17 GC/MS	Solvent Extraction GC/MS or GC/FID	TO-17 GC/MS	TO-17 GC/MS	Solvent Extraction GC/MS	TO-17 GC/MS
Estimated analytical reporting limit	0.05–0.1 µg/m ³	1–10 ng	100–200 ng	1–10 ng	75–200 ng	1–10 ng	1–10 ng	50–200 ng	1–10 ng
Expected sampling rate	0.5–3.5 mL/min	10–200 mL/min	~60 mL/min	~25 mL/min	~10 mL/min SKC ~30 mL/min 3M	~10 mL/min	~0.5 mL/min	~0.5–5 mL/min	~0.5–5 mL/min
Recommended sampling duration	Typically 24 hours	8–24 hours	Up to 30 days	Up to 7 days for chlorinated solvents	Up to 4 weeks	1–7 days	In general, up to 4 weeks).	Up to 30 days	Up to 30 days
Estimated sample reporting limits ^a	~0.05 (SIM)–0.1 µg/m ³	~0.1–1 µg/m ³	~0.1–0.4 µg/m ³	~0.005–0.05 µg/m ³	~0.25–2 µg/m ³	~0.01–0.1 µg/m ³	~0.2–2 µg/m ³	~1–40 µg/m ³	~1–40 µg/m ³
Applicable range of chlorinated solvents (based on available sampling rates)	TCE/PCE and all breakdown products including vinyl chloride (VC)	TCE/PCE and all breakdown products including VC	TCE, PCE, 111-TCA, chloroform	TCE, PCE, 111-TCA	Validated for a wide range of chlorinated solvents for 8 hours, several for up to 30 days.	TCE, PCE, DCE, 111-TCA, chloroform, 12-DCA, cis-12-DCE, trans-12-DCE, 11-DCA.	TCE, PCE, 111-TCA	TCE, PCE, and most breakdown products	TCE, PCE, and most breakdown products

^a Normalized to a 7-day period for diffusive samplers.

Very few studies have evaluated VOC measurements using diffusive samplers beyond 30 days, and determining if this is possible is one objective of this study. The sorbent selection, the sampler geometry, and the target chemical's volatility all may have a significant impact on the successful application of diffusive samplers to extended deployment periods. The few published studies evaluating sampling intervals greater than 30 days are largely focused on the measurement of BTEX (Bertoni et al., 2001; Brown and Crump, 1993), and the stability of chlorinated compounds on sorbents in the presence of humidity and the variability of the sampling rate past 30 days are not well understood for any of the diffusive samplers under consideration for this study.

Given the previous studies and the existence of standard methods for this application in Europe, the 1- and 2-week Radiello passive samplers for VOCs are considered sufficiently accurate and precise to be the primary VOC measurement tool in this project and are used as a basis of comparison for longer duration samples.

2.2 Objectives

The main goal of this project is to investigate distributional changes in VOC and radon concentrations in the indoor air, subslab, and subsurface soil gas from an underground source (groundwater source and/or vadose zone source) adjacent to a residence or small commercial building. The time frame of this study is over a year (about 14 months) in order to evaluate the effects due to seasonal variations on radon and VOC vapor intrusion.

There are four primary objectives for this research effort:

1. Identify any seasonal fluxes in radon and VOC concentrations as they relate to a typical use of HVAC in the building.
2. Establish the relationship between subslab/subsurface soil gas and indoor air concentrations of VOCs and possibly radon.
3. Determine the relationship of radon to VOC concentrations at a given site.
4. Examine if near-building external samples could be used as a surrogate sampling location.

Five secondary objectives have also been defined:

1. Evaluate the duration over which solvent-extracted passive samplers provide useful integration of indoor air concentrations (i.e., over what duration is the uptake rate constant?).
2. Characterize the near-building environment sufficiently to explain the observed variation of VOCs and radon in indoor air.
3. Determine whether the observed changes in indoor air concentration of volatile organics of interest can be mechanistically attributed to changes in vapor intrusion.
4. Confirm that the two analytical laboratories (Air Toxics and US EPA) can produce soil gas VOC data with sufficient agreement, that the variance between laboratories is not significant compared with the variance between laboratories or the changes in the underlying phenomena being observed.
5. Evaluate the extent to which groundwater concentrations and/or vadose zone sources control soil gas and indoor air VOC concentrations at this site.

Characteristics of the experimental design and data quality objectives developed to meet these objectives are described below.

2.2.1 Time Scale and Measurement of Independent and Dependent Variables

In our overall study design, we used weekly measurements to observe our dependent variable—indoor air concentration. We expected the indoor air concentration to be dependent on the flux from vapor intrusion from soil gas. Our dependent variable is thus controlled by a series of independent variables with different time cycles that affect the vapor intrusion process, including barometric pressure, soil moisture, soil temperature, water level, HVAC operation, and air temperature.

In the course of this study, we monitored or measured most of these independent variables or their surrogates and different frequencies balancing on the general desire for continuous measurements against logistic considerations. **Table 2-2** considers these time-scale issues and the implications they may have for our test matrix. Figures in Nazaroff and Nero (1988) show examples of how such independent variables controlled indoor radon concentrations in previous studies.

Table 2-2. Factors Causing Temporal Change in Vapor Intrusion and How They Are Observed and Measured

Independent Variables/Causes of Variability	Expected Time Cycle	Indoor VOC & Soil Gas Measurement Intervals Available to Observe at These Time Scales	Measurements of Independent Variables Available
HVAC system on/off	<ul style="list-style-type: none"> ▪ 10 min–1 hour 	None: all measurements 24 hours or longer	Measurement with data logger was planned every five minutes within heating season.
Diurnal temperature/wind (night/day)	<ul style="list-style-type: none"> ▪ 24 hour 	None: all measurements 24 hours or longer	Weather station: at least one data point per hour
Barometric pumping from weather fronts	<ul style="list-style-type: none"> ▪ 2–3 days typical 	Weekly, except for daily samples and continuous measurements during intensive periods.	Weather station: ambient pressure logging with at least one point per hour.
Water table fluctuations	<ul style="list-style-type: none"> ▪ Barometric pressure: 2–3 days ▪ Major rain events: irregular ▪ Seasonal climate: monthly ▪ Surface events: blasting, railroad operations, etc.: minutes, irregular 	Monthly integrated indoor air samples	Monthly water-level measurements
Soil and groundwater temperature change	<ul style="list-style-type: none"> ▪ Annual/seasonal 	Weekly, biweekly, and quarterly samples of indoor air and soil gas	Soil temperature logging with thermocouples: one or more points per hour. Groundwater temperature monthly during sampling.
Vadose zone moisture change	<ul style="list-style-type: none"> ▪ Seasonal major rain events? 	Weekly samples of indoor air and soil gas	Once per hour at 5 depths
Stack-effect, heating vs. cooling season	<ul style="list-style-type: none"> ▪ Daily and seasonal 	Weekly samples of indoor air and soil gas	Differential pressures, indoor temperatures: 15-minute rolling average

2.2.2 Data Quality Objectives and Criteria

Table 2-3 summarizes the data quality objectives and criteria for this project. Each objective is expressed first qualitatively, and then each objective is expressed in quantitative and statistical terms where possible. The measurements that were used to achieve each objective are also listed. More details on the measurements to be made are given in Section 3 of this report.

Table 2-3. Data Quality Objectives and Criteria

Task Order Objective	Measurements Used	Study Question	Performance or Acceptance Criteria
Primary (Explicit) Objectives			
A-1. Determine relationship of radon to VOC concentrations in soil gas and in indoor air.	Radon and VOC measurements in indoor air and soil gas (subslab and subsurface).	<ul style="list-style-type: none"> Is there a statistically significant correlation of radon to VOC concentrations for each medium? 	<p><i>Replicate measurements:</i> +/-30%</p> <p><i>Completeness:</i> Number of measurements in medium is adequate to draw quantitative conclusions.</p>
B-1. Establish attenuation between subslab and indoor air concentrations of VOCs and radon.	Radon and VOC measurements in subslab soil gas and basement indoor air.	<ul style="list-style-type: none"> What is the range and mean of the subslab to indoor air attenuation factors for VOCs and radon? Is there a statistical relationship? 	<p><i>Replicate measurements:</i> +/-30%</p> <p><i>Attenuation factor range:</i> 2-4 orders of magnitude.</p> <p><i>Completeness:</i> Adequate measurements for quantitative conclusions.</p>
C-1. Examine whether external soil gas samples near building can be used as surrogates for subslab, and at what depth.	Correlated (by time) external soil gas sampled between 4 ft and 16 ft bgs, subslab soil gas, and indoor air.	<ul style="list-style-type: none"> At what depth does the external soil gas adequately predict average subslab and indoor air concentrations, using EPA attenuation factors? What is the statistical goodness of fit between predicted and actual indoor air values? 	<p><i>Replicate measurements:</i> +/-30%, based on several orders of magnitude variability in soil gas and subslab attenuation factors.</p> <p><i>Attenuation factor range:</i> 2-4 orders of magnitude.</p> <p><i>Completeness:</i> Adequate measurements for quantitative conclusions.</p>
D-1. Identify seasonal variations in radon and VOC vapor intrusion flux (i.e., indoor air concentrations) and relate to the use of home HVAC system.	Weather information, VOC and radon concentration time series in indoor air, differential pressure, air exchange rate.	<ul style="list-style-type: none"> Are there statistically significant seasonal trends in radon and VOC indoor air concentrations? If so, do they correlate with HVAC operation and differential pressures across the slab? Are there alternative factors? 	<p><i>Replicate measurements:</i> +/-30%, based on 2x-5x expected seasonal variability in indoor air concentration.</p> <p><i>Completeness:</i> Adequate measurements for quantitative conclusions.</p>

(continued)

Table 2-3. Data Quality Objectives and Criteria (continued)

Task Order Objective	Measurements Used	Study Question	Performance or Acceptance Criteria
Secondary (Implicit) Objectives			
Implicit-1. Determine sample duration limits for solvent-extracted passive indoor air samplers (i.e., is uptake rate constant over time?).	Solvent-extracted passive sorbent samples with varying duration at same location: weekly, biweekly, monthly, quarterly, annually. 1-week samples are the standard for comparison.	<ul style="list-style-type: none"> Are the integrated concentrations measured with 1-week samples statistically equivalent to those measured for longer periods? 	<p><i>Replicate measurements:</i> +/-30%, based on typical risk assessment safety factors of at least one order of magnitude.</p> <p><i>Completeness:</i> Adequate measurements for quantitative conclusions.</p>
Implicit-2. Determine if observed changes in indoor air concentration of volatile organics of interest are mechanistically attributable to changes in vapor intrusion	Indoor concentration, pressure differential, concentrations in immediate subslab soil gas samples, concentrations in the shallow soil gas samples immediately adjacent to the basement walls, concentrations in ambient air.	<ul style="list-style-type: none"> Is the observed variance in indoor air concentration correlated to changes in differential pressure across the slab, immediate subslab concentration, soil gas concentration immediately adjacent to the basement walls, or some combination of these? Is the observed variance in indoor air concentration correlated to changes in ambient air concentration? 	<p>+/-30% accuracy for soil gas and indoor air concentration. +/-0.5 Pa for differential pressure (expected range +10 Pa to -10 Pa).</p> <p>Indoor air, immediate subslab soil, and soil gas concentrations outside the basement wall were measured weekly. Differential pressure was measured more frequently. Thus, an analysis of which factors contribute to the variance in 52 measurements of the independent variable is possible.</p>
Implicit-3. Characterize the near building environment sufficiently to allow future 3D modeling of this site	All measurements in the text matrix contribute, including soil lithological logging, utility corridor mapping, characterization of soil TOC and bulk density, building air exchange rate.	<ul style="list-style-type: none"> Since an extensive modeling exercise is not currently funded, a formal numerical criterion for model fit to field data is not being established at this time. 	The planned dataset is as or more extensive than any known vapor intrusion dataset on a single building. The accuracy requirements for the principal measurements defined in the other objectives are anticipated to be adequate for future modeling as well.
Implicit-4. Confirm that the two analytical laboratories (Air Toxics and US EPA) can produce soil gas VOC data with sufficient agreement, that the variance between laboratories is not significant compared to the changes in the underlying phenomena being observed	Collocated or split duplicate soil gas samples analyzed by both laboratories. A set of replicate soil gas samples were acquired by following normal soil gas sampling purge procedures for this project. Then four samples were collected in rapid sequence. Samples A and C were submitted to Air Toxics, samples B and D to EPA for analysis.	<ul style="list-style-type: none"> Do the Air Toxics and EPA analyses of duplicate/collocated soil gas samples agree with each other to +/-30%? Is the variability between duplicates analyzed by two different laboratories significantly greater than duplicates analyzed by any one laboratory? 	We plan to acquire at least 5 quartets of split samples for analyses by the two laboratories.

(continued)

Table 2-3. Data Quality Objectives and Criteria (continued)

Task Order Objective	Measurements Used	Study Question	Performance or Acceptance Criteria
<p>Implicit-5. Evaluate the extent to which groundwater concentrations control soil gas concentrations at this site and thus indoor air concentrations.</p>	<p>Measurement of VOCs in groundwater, soil gas at various depths and indoors.</p>	<ul style="list-style-type: none"> ▪ Is the temporal variability in immediate subslab soil gas concentration primarily attributable to the variability in deep soil gas concentration? ▪ Is the temporal variability in deep soil gas concentration primarily attributable to the temporal variability in groundwater concentration? ▪ Is the temporal variability in indoor air concentration primarily attributable to the temporal variability in groundwater concentration? ▪ Does the three-dimensional pattern of subslab and external soil gas concentrations suggest that the primary source of VOCs to indoor air is migrating from a groundwater source (between 16 ft bgs) or a source in the vadose zone? This can be evaluated by determining if the highest soil gas concentrations in subslab soil gas are matched or exceeded by deep soil gas or shallow soil gas external to the house. 	<p>Each measurement is expected to be +/- 30% accuracy or better. Because only two groundwater well clusters are planned, data analysis for this objective focuses on those two clusters and the soil gas sampling points most proximate to them. Each of the groundwater wells were sampled monthly.</p>

Table of Contents

3.	Methods.....	3-1
3.1	Site Description	3-1
3.1.1	Area Geology/Hydrogeology	3-1
3.1.2	Area Potential Sources	3-3
3.1.3	Building Description	3-7
3.1.4	Building Occupancy During Sampling	3-9
3.1.5	Initial Site Screening	3-9
3.1.6	Initial Conceptual Site Model.....	3-13
3.2	Building Renovation.....	3-14
3.2.1	HVAC Refurbishment and Operations.....	3-14
3.2.2	Plumbing Refurbishment and Sealing.....	3-17
3.3	Monitoring Infrastructure Installation (Wells, SGPs, Embedded Temperature Sensors).....	3-18
3.4	VOC Sampling and Analysis.....	3-23
3.4.1	Indoor (Passive, Summa Canister)	3-23
3.4.2	Subslab and Soil Gas (TO-17 and Summa Canister)	3-25
3.4.3	Online Gas Chromatograph.....	3-25
3.4.4	Groundwater.....	3-27
3.5	Radon Sampling and Analysis.....	3-27
3.5.1	Indoor Air Radon Sampling and Analysis.....	3-27
3.5.2	Subslab and Soil Gas Radon Sampling and Analysis	3-28
3.5.3	Continuous (Real-Time) Indoor Air Radon Sampling and Analysis	3-29
3.6	Physical Parameters Monitoring.....	3-29
3.6.1	On-Site Weather Station.....	3-29
3.6.2	Indoor Temperature.....	3-31
3.6.3	Soil Temperature	3-31
3.6.4	Soil Moisture	3-31
3.6.5	Potentiometric Surface/Water Levels.....	3-32
3.6.6	Differential Pressure.....	3-32
3.6.7	Air Exchange Rate.....	3-32
3.6.8	Crack Monitoring	3-33

List of Figures

3-1.	Lithological fence diagram showing the major soil types beneath the 422/420 house.....	3-2
3-2.	Aerial view of duplex, 420/422 East 28th Street, showing nearby sanitary and storm sewers.....	3-3
3-3.	East side of house (on right) and adjoining commercial quadraplex visible (left).	3-4
3-4.	Roof of adjacent commercial quadraplex.	3-4
3-5.	Looking toward southeast corner of adjacent commercial quadraplex.....	3-5
3-6.	Visual evidence of historic dry cleaners in area.	3-6
3-7.	Front view of house during summer 2011 sampling, with fan testing and weather station.....	3-7
3-8.	Front view of duplex under winter conditions showing designation of sides and HVAC setup	3-8
3-9.	422 (left) and 420 East 28th Street in January 2011.	3-8
3-10.	Test building floor plan showing sampling locations used in preliminary screening.....	3-11
3-11.	Basement supply register in newly installed HVAC system.	3-14
3-12.	Common returns from first and second floors in newly installed HVAC system.....	3-15
3-13.	Gas-fired forced hot air HVAC system installed in 422.....	3-15

3-14.	Floor cracks in 422 basement, central area, contrast enhanced.	3-17
3-15.	Weathered cement in walls and floor cracks in 422, contrast enhanced.....	3-17
3-16.	Floor drain, 422, 1st floor laundry area.	3-18
3-17.	Nested monitoring well 1 and SGP1 are located immediately south of the 422 side front wall. SGP1-16.5 and MW-1A is by the wall, to the left of the sign. SGP1-9 and 1-13 as well as MW-1C are by the wall, to the right of the sign (next to the pile of bricks). SGP1-3.5 and 1-6, and MW-1B are in the installation visible in the center foreground.....	3-19
3-18.	Exterior of test building showing utility corridors, ground surface cover, monitoring wells (MWs), soil gas points (SGPs), thermocouples (TCs), and moisture sensors (MSs).	3-20
3-19.	Interior floor plans of 420 and 422 East 28th Street showing sampling locations.....	3-21
3-20.	Interior SGP9 (top) and SSP-4 (bottom).....	3-22
3-21.	Wall port 2.	3-22
3-22.	Passive indoor air sampling rack: 422 first floor.	3-23
3-23.	Ambient sampler shelters on telephone pole near duplex.....	3-24
3-24.	Monitoring well MW-3, installed in the basement and completed on the first floor.....	3-27
3-25.	Front view of 420/422 duplex with location of weather station sensors indicated with red arrow.	3-30
3-26.	Calibrated crack monitor.....	3-33

List of Tables

3-1.	Preliminary Indoor Air VOC Screening Results—Fan Off, Basement	3-10
3-2.	Preliminary Indoor Air Radon Screening—Fan Off, Basement	3-12
3-3.	VOC Results ($\mu\text{g}/\text{m}^3$) for Subslab and Soil Gas at 422 E. 28th St., Indianapolis—Fan Off	3-12
3-4.	VOCs ($\mu\text{g}/\text{m}^3$) in Indoor Air and Subslab Soil Gas, 420 & 422 E. 28th St., Indianapolis—Fan On.....	3-12
3-5.	Radon (pCi/L) in Indoor Air & Subslab Gas at 420 & 422 E. 28th St. Indianapolis— Fan Off and On	3-12
3-6.	Groundwater Screening Data.....	3-13
3-7.	Soil Analysis from MW-1 Boring at Multiple Depths.....	3-13

3. Methods

3.1 Site Description

We selected a vacant residential duplex at 420/422 East 28th Street in Indianapolis for testing. This house lies in the Mapleton-Fall Creek neighborhood (IndyGov, 2012). This area of Indianapolis was initially a farming settlement known as Mapleton founded in the 1840s. The primary residential development in this area occurred in the late 1800s and early 1900s. Commercial development on the immediate cross street, Central Avenue, began in the 1920s.

3.1.1 Area Geology/Hydrogeology

Several soil borings were advanced in the area immediately surrounding the house, during monitoring well (MW) construction and soil gas port (SGP) installation. SGP1A, SGP1B, and SGP1C, as well as MW-1A and MW-1B, were installed on April 29, 2010. All additional SGPs and MWs on the exterior of the house were installed between August 30 and September 1, 2010. SGPs and MW-3 located below the footprint of the house were installed in September 2010. Three-dimensional visualizations of subsurface lithology are presented in **Figure 3-1**. Boring logs are included in **Appendix A**.

In the southern portion of the property, topsoil extends down to about 0.5 to 1 ft. Beneath the topsoil is sand or silt mixed with cinders, coal fragments, or ash to about 1.5 ft. From 1.5 ft to between 5 and 6 ft is silt or silty sand with varying amounts of clay. Some trace gravels start at about 7 ft, and underlying that layer are sands and gravels to between 15 and 16 ft. Beneath the sand and gravel layer is generally sand.

To the east side of the property, at the surface, are soils with a visibly high organic content and a gravel or a concrete sidewalk. Underlying the surface soil from 1 to 3 ft is sand or clayey sand, with some gravel and coal fragments in some borings. Beneath that layer down to 7 ft is predominantly clay with some sand or silt. Underlying that layer is a layer of sand with some clay and gravel down to about 12 to 14 ft. From 14 to 16.25 ft is a layer of sand with gravel to 16.5 ft.

To the north side of the property, the first foot is fill, sand, and gravel. From 1 to 3 ft is brick, with sand and weathered brick to 3.5 ft. The brick constituent in this location is possibly a remnant of a former exterior basement stairwell. From 3.4 to 6.25 ft is a silty, sandy clay. From 6.5 to 8 ft is sand, with sand, gravel, and some clay down to 12 ft. From 12 to 16 ft is all sand.

On the west side of the property, the first half-foot beneath the surface is the concrete sidewalk. Underlying that to 1.25 ft is fill, cinders, and gravel. From 1.25 to 6.75 ft is a silty, sandy clay with trace gravel. The layer beneath that to 15.5 ft is sand and gravel with some clay followed by sand to the end of the boring at 16.5 ft. See Section 6.1 for additional information on site soils.

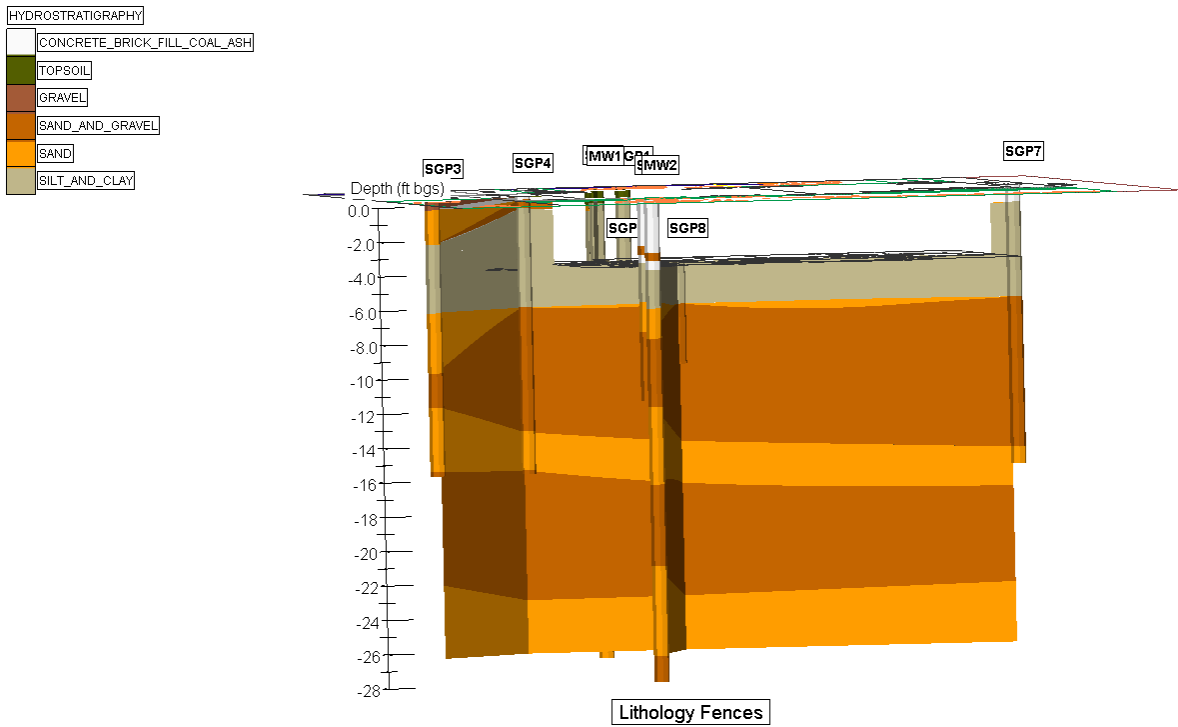
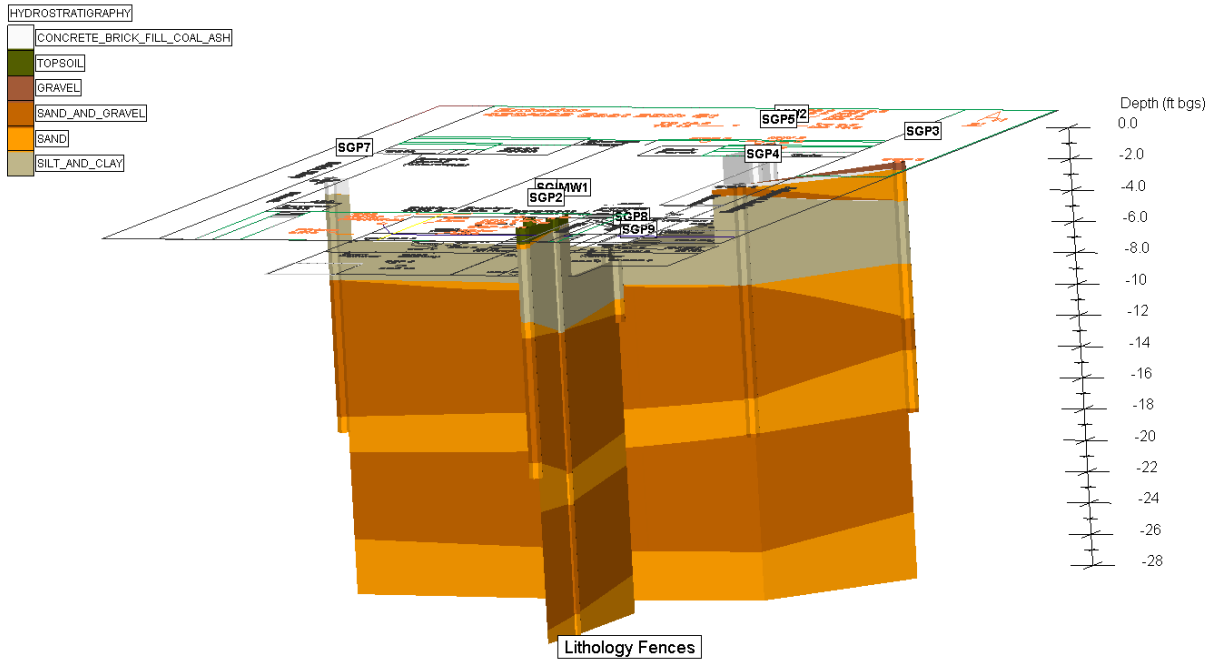

Figure 3-1. Lithological fence diagram showing the major soil types beneath the 422/420 house.

In the top figure, the view is toward the north from the street in front of the house. The bottom figure shows a view toward the south from the backyard. The empty white area at the top of the soil figure represents the house basement. In the immediate vicinity of the house, silt and clay (brown) are present until 7.5 to 8 ft below land surface (b/s). After that, sand and gravel (burnt orange) alternate with layers of sand (orange).

3.1.2 Area Potential Sources

The site location, as illustrated in **Figure 3-2**, is bounded to the south by 28th Street, to the west by North New Jersey Street, and to the east by Central Avenue. There is a large stream, Fall Creek, approximately 300 ft to the south of the site toward which groundwater generally trends. Across the street south of the site, there is a parking lot and to the east there is an open field. Across an alley to the west of the site, there is an open lot with a grassy area and a paved parking lot. Adjacent to the north side of the site there are backyards of the residential buildings along Central Avenue.



Figure 3-2. Aerial view of duplex, 420/422 East 28th Street, showing nearby sanitary and storm sewers.

Immediately adjacent to the studied duplex (approximately 10 ft east) lies a small commercial/residential quadraplex (**Figures 3-3, 3-4, and 3-5**) with a diverse, primarily commercial history dating back to 1930. The four portions of the building are numbered as 424 East 28th Street, 426 East 28th Street, 2802 Central Avenue, and 2804 Central Avenue.



Figure 3-3. East side of house (on right) and adjoining commercial quadraplex visible (left).



Figure 3-4. Roof of adjacent commercial quadraplex.



Figure 3-5. Looking toward southeast corner of adjacent commercial quadruplex.

Among the historic uses of parts of that building were a pharmacy and beauty supply, radio, fur, and detector companies. Regarding most of the businesses that occupied that space, only their names are currently known and those names do not match any businesses with a current local or Internet presence. Thus, chemical uses, though probable, are not documented. The back part of the adjacent building at 2804 Central Avenue has historically been occupied by “Wolf Fur Co.” Later in 1954, the same location was occupied by the “Avideo Detectors Telaveta.” In 1930, it was occupied by “Gould & Schildmoler ENEN” and “Home Radio Co.” The records for the adjacent buildings (424 to 428 East 28th Street and 2802 to 2804 Central Avenue) show a number of drug store and beauty shop uses. There are substantial gaps in the records for these properties; there seems to be little or nothing reported about what was occupying these locations between 1970 and 2000.

There were 9 to 10 historic laundry cleaners located less than a quarter of a mile to the north of the 422/420 house, and one was a quarter of a mile to the west (**Figure 3-6**). These laundry cleaners were listed as hand and steam laundries, pressers, and driers. The most recent laundry was present in 1970 (Environmental Data Resources (EDR) Radius Map, June 15, 2010). In the fall of 2010, we observed Mapleton-Fall Creek Development Corporation (MFCDC) staff excavating an underground storage tank that appeared to contain product at a dry cleaner several blocks upgradient from the 422/420 house.

There were three historic gas stations or auto service and repair shops within a quarter of a mile to the north as well. The most recent auto repair shop was present in 1990 (EDR Radius Map, June 15, 2010).



Figure 3-6. Visual evidence of historic dry cleaners in area.

The property southwest of the intersection of East 28th Street and Central Avenue was historically mildly impacted with petroleum hydrocarbons and managed as a Brownfield named “Mapleton-Fall Creek Site” or “Fall Creek Central Project.” This site was closed after tank and soil removal. One round of volatile organic compound (VOC) groundwater data was acquired at that location that showed detectable chloroform (8.9 to 22.1 $\mu\text{g/L}$ in a June 2005 sampling event). These previous studies showed that the study area has sand and gravel geology from approximately 7 to 25 ft below land surface (bls) and groundwater at approximately at 16 ft bls. The upper 7 ft of the stratigraphy is heterogenous, variously described as including fill materials, loam, and silty and moist sandy clay.

Based on the general topography of the area and professional experience in this portion of Indianapolis, groundwater is thought to flow from the north of the 422/420 house south of the house to Fall Creek. Thus, many of the historic laundries or auto shops that are potential contaminant sources are generally upgradient of the studied house.

The 422/420 duplex is located between Central Avenue and its associated alleyway on 28th Street. The immediate area receives a moderate amount of traffic, but the Central Avenue/Fall Creek Parkway intersection is very busy throughout most of the day. Traffic could be a contributing factor to petroleum-based contaminants in surface soils.

3.1.3 Building Description

3.1.3.1 Building Age, Condition, and HVAC

The tested house located at 422/420 East 28th Street, Indianapolis, IN (**Figure 3-7**) is an early twentieth century duplex, dating from before 1915 because it is present on the 1915 Sanborn map of the area. Based on the mirrored floor plans of the two sides, it is likely that the house was always a duplex. Construction is wood frame on a brick foundation with a poured concrete basement floor. Interior floor materials include tile, carpet, and wood flooring.



Figure 3-7. Front view of house during summer 2011 sampling, with fan testing and weather station.

The duplex at 422/420 was previously vacant and is now owned by Mapleton-Fall Creek Development in Indianapolis. Before our involvement, the house had been vandalized and stripped of all valuable metals and fixtures. In all likelihood, the house was never to be restored for use. An operative from the Indianapolis ARCADIS office acquired the use of the house for the duration of the project. The vandalism and theft of household items included the following: all copper wiring and tubing, most plumbing fixtures, and many outlets. Vandals destroyed the previous HVAC unit, probably in an attempt to obtain any valuable metals. We restored power to the house in September 2010. A gas-fired forced air HVAC unit was installed on the 422 side in October 2010 by Edward's Electric for use in this project (**Figure 3-8**). The house had no air conditioning (AC) system, and we chose to install window-mounted units, which would have been the likely type used by any tenants in this house.

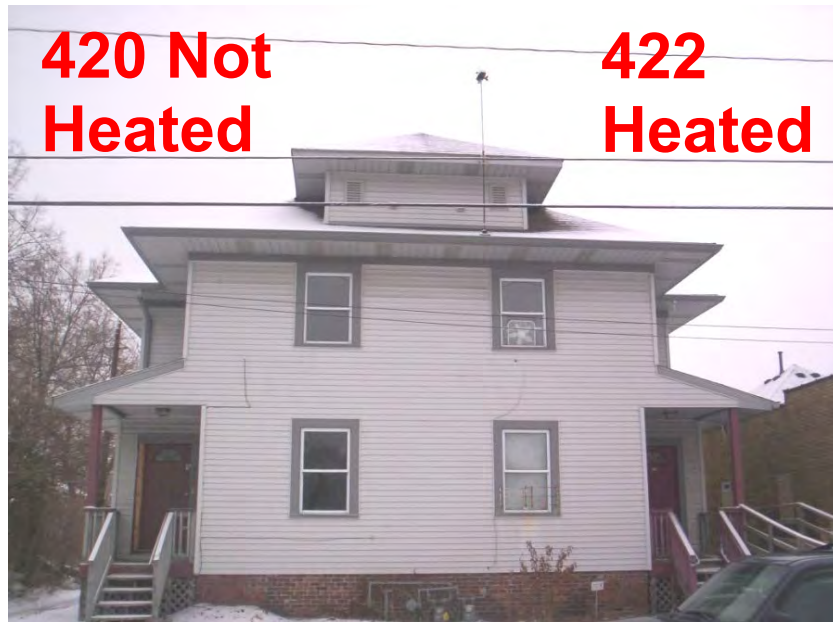

Figure 3-8. Front view of duplex under winter conditions showing designation of sides and HVAC setup.



Figure 3-9. 422 (left) and 420 East 28th Street in January 2011.

There are internal and external visual clues indicating (**Figure 3-9**) the house has been updated several times. For example, visual clues suggest that a previous HVAC unit had been installed that was not native

to the house's original construction. In the basement, there is evidence of former coal chutes (possibly) and cisterns on both the 420 and 422 sides. The probable coal chutes and old windows had been blocked by cinder blocks before ARCADIS occupancy. The cisterns had also been cemented over. Comments made by electricians in the basement suggest that at one time the house had been heated by an old style furnace, indicated by cemented-over holes in the walls, but that the furnace had been gone for some time.

3.1.3.2 Building Utilities/Potential Entry Points

The electric lines connect to the house at the northwest corner of the 420 side. Because all original wiring native to the house had been removed by vandals before the project, we had to have the junction box rewired to the city electrical line and run new lines within the house to new outlets at designated points. The gas line connects only to the furnace from an access line in the south wall of the 422 side. Both the electrical lines and the gas line were emplaced by Edward's Electrical during the furnace installation and enter the house at the original entry points for each utility.

Sanitary sewer lines run immediately south of the house along East 28th Street. Sanitary and combined sewer lines run less than one block east and west of the house along Central Avenue and New Jersey Street (see previous **Figure 3-2**). There is a sewer line running beneath the basement floor along the length of the 422 side from north to south that was buried and cemented over sometime after the floor's original construction. PVC drain lines join this sewer line, running laterally from the plumbing on both sides of the duplex. The HVAC unit drains condensation into a floor grill leading to the lateral. A nonfunctional water line enters the house from the south. Large, cinder-blocked portions of the north interior basement walls of both sides of the duplex along with brick strata in borings have been observed. We interpret these cinder-blocked walls to be vestigial entranceways to the basement from a time when the basement was accessed from the back yard, rather than from an interior basement door.

3.1.4 Building Occupancy During Sampling

The initial concept for the 422/420 house was to create an environment free from lifestyle-related indoor air sources, but operated as though the space were occupied, to simulate a living environment. The 422/420 house was borrowed from MFCDC, which owns the property. It was thought that the house would eventually be torn down because it had been previously abandoned and vandalized. We thought that the house would be ideal because it had no occupants, limited use beyond the project, an ideal location, and vapor intrusion was present.

Because the house was in poor condition and the house had no occupants, we could make any alterations to the house necessary to set up ports, wells, and sensors for observations. Changes were made without having to consider the occupants' comfort. For example, the fan testing (to be described in Section 12.2) would have been inconvenient for a homeowner.

To more closely simulate a living environment, a field scientist worked on-site during most normal work weeks during the year of intensive sampling, for several months before intensive sampling began, and during many off times as the need required. The intent was to have an individual who would open doors and windows, move through the environment, and make temperature adjustments when the seasons dictated, similar to the way a homeowner would. The constant close proximity of the worker to the work zone also allowed for quick responses to environmental changes. A second floor bedroom on the 422 side of the duplex was minimally modified and used as an office for the sampling staff member.

3.1.5 Initial Site Screening

A preliminary indoor air screening evaluation was conducted March 15 to 17, 2010, where basement indoor air samples were collected and analyzed for VOCs and radon. A second radon sampling was conducted from March 27 through April 1, 2010. The heat and the fan were off during these sampling

events. The VOC and radon results are presented in **Tables 3-1** and **3-2**, respectively. Detected concentrations of perchloroethane (PCE), chloroform, and radon were at levels of 2.8 $\mu\text{g}/\text{m}^3$ for PCE, 3.3 $\mu\text{g}/\text{m}^3$ for chloroform, and 4.98 pCi/L for radon.

Initial sampling for subslab and soil gas VOC evaluation took place May 6–7, 2010. The heat and fan were off during this sampling event. The results are presented in **Table 3-3** and indicate higher PCE concentrations in subslab and deep soil gas. Therefore, it was unclear if the VOC impact at the site is from groundwater source, from a deep vadose zone source, or from both.

A confirmatory sampling event took place June 23 through June 25, 2010, for VOCs, and June 23 through July 14, 2010, for radon. At this sampling event, a fan was turned on during sampling to create or increase the differential pressure that could enhance the vapor intrusion. Samples were taken from indoor air (first floor and basement) and from the subslab; no soil gas samples were taken in this event. All sampling locations used in this initial screening are presented in **Figure 3-10**. The results for the VOC and radon screening analysis are presented in **Tables 3-4** and **3-5**, respectively.

Table 3-1. Preliminary Indoor Air VOC Screening Results—Fan Off, Basement

Duration (min)	420 E. 28thSt., Indianapolis		422 E. 28thSt., Indianapolis	
	1003392-01A		1003392-02A	
	File: 2879	f031909	File: 2878	f031910
Compound	ng	$\mu\text{g}/\text{m}^3$	ng	$\mu\text{g}/\text{m}^3$
t-1,2-Dichloroethene*	1.6	0.024	2.0	0.030
cis-1,2-Dichloroethene*	<2.0	<0.030	13	0.19
Chloroform*	16	0.27	198	3.3
1,1,1-Trichloroethane	<5.5	<0.096	7.3	0.127
Benzene	160	2.0	160	2.0
1,2-Dichloroethane*	4.7	0.070	5.2	0.078
Trichloroethene	4.6	0.059	17	0.21
Toluene	340	3.9	342	4.0
Tetrachloroethene	52	0.71	202	2.8
Ethylbenzene	51	0.69	51	0.69
m,p-Xylene	160	2.1	160	2.1
o-Xylene	59	0.84	58	0.81
Styrene	16	0.21	14	0.18
1,3,5-Trimethylbenzene*	37	0.59	33	0.52
1,2,4-Trimethylbenzene	17	0.27	15	0.23

* Estimated sampling rate

Note: No vinyl chloride was identified.

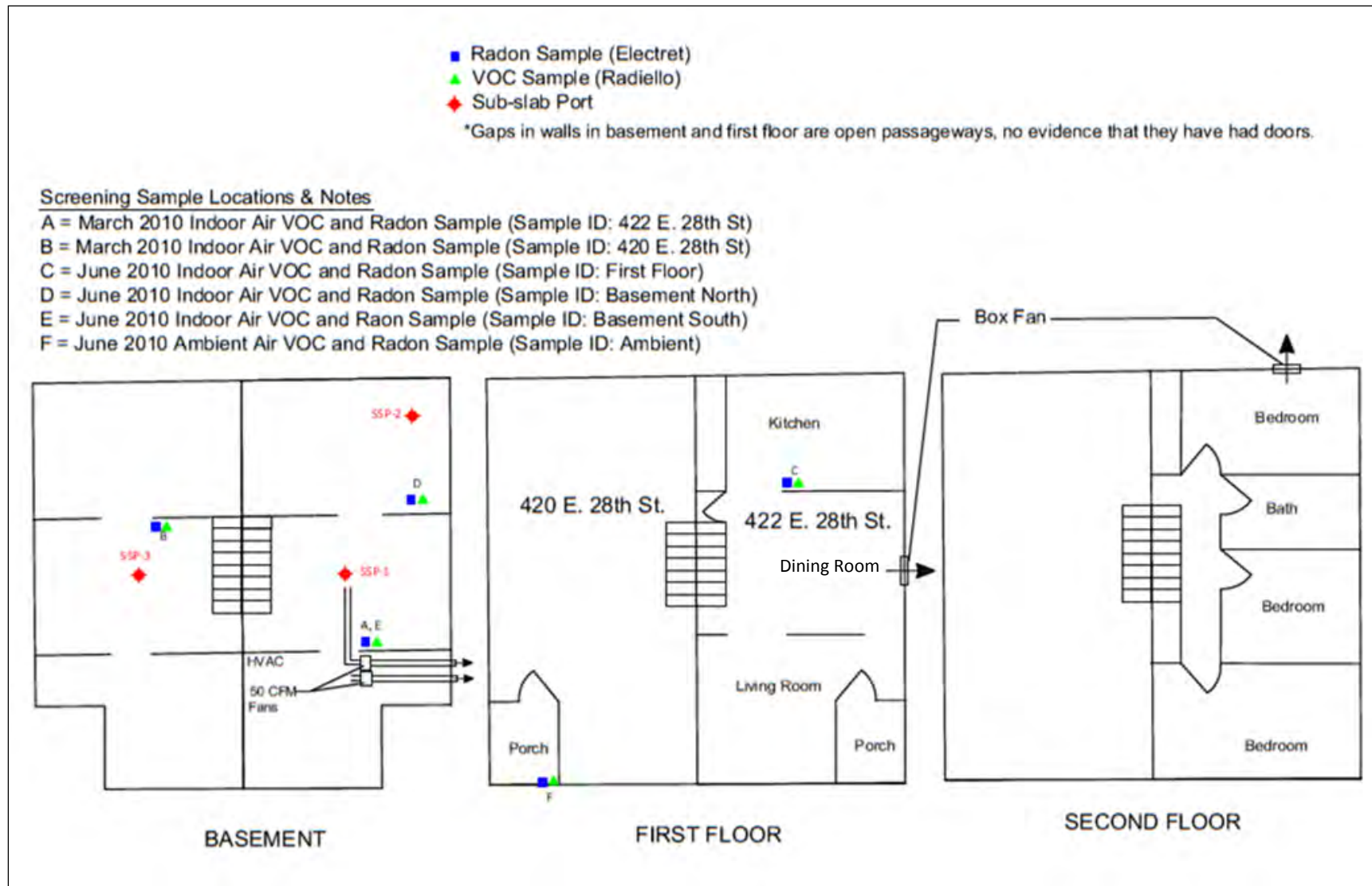

Figure 3-10. Test building floor plan showing sampling locations used in preliminary screening.

Table 3-2. Preliminary Indoor Air Radon Screening—Fan Off, Basement

Sample ID	Start Test Start Date/Time	Finish Test End Date/Time	Days	Radon pCi/L
422 E. 28th St.	3/26/10 9:32	4/1/10 15:32	6	3.5
420 E. 28th St.	3/26/10 9:38	4/1/10 15:38	6	4.2
422 E. 28th St.	3/15/10 14:34	3/17/10 14:32	2	5.0
420 E. 28th St.	3/15/10 14:42	3/17/10 14:41	2	3.5

Table 3-3. VOC Results ($\mu\text{g}/\text{m}^3$) for Subslab and Soil Gas at 422 E. 28th St., Indianapolis—Fan Off

Location	Date	Carbon Disulfide	Chloroform	PCE
SSP-1 (subslab center, 422 E. 28th St.)	5/7/2010	<36	<56	170
SSP-2 (subslab northeast, 422 E. 28th St.)	5/7/2010	<34	<53	<73
SGP1B (9 ft)	5/6/2010	43	140	100
SGP1A (13 ft)	5/6/2010	<34	130	90
SGP1C (16.5 ft)	5/6/2010	43	120	130

The data presented in **Table 3-4** and **Table 3-5** show a significant increase in indoor air and subslab concentrations when the fan is on, indicating that vapor intrusion was enhanced by building under-pressurization.

Table 3-4. VOCs ($\mu\text{g}/\text{m}^3$) in Indoor Air and Subslab Soil Gas, 420 & 422 E. 28th St., Indianapolis—Fan On

Location	Date	Carbon Disulfide	Chloroform	PCE
Indoor air FF (First floor, 422 E. 28th St.)	6/23–25/2010	Not analyzed	6.9	3.6
Basement north (422 E. 28th St.)	6/23–25/2010	Not analyzed	64	49
Basement south (422 E. 28th St.)	6/23–25/2010	Not analyzed	27	24
SSP-1 (subslab center, 422 E. 28th St.)	6/23–25/2010	<35	<55	330
SSP-2 (subslab NE, 422 E. 28th St.)	6/23–25/2010	<35	<55	<76
SSP-3 (subslab, 420 E. 28th St.)	6/23–25/2010	<35	<55	<77

Table 3-5. Radon (pCi/L) in Indoor Air & Subslab Gas at 420 & 422 E. 28th St. Indianapolis—Fan Off and On

Location	Fan Off (Mar–Apr/2010)	Fan On (Jun–Jul/2010)
Indoor air (basement 420 E. 28th St.)	3.5	Not measured
Indoor air FF (first floor, 422 E. 28th St.)	Not measured	2.5
Basement north (422 E. 28th St.)	5.0	7.8
Basement south (422 E. 28th St.)	Not measured	13
SS-1 (subslab center, 422 E. 28th St.)	Not measured	530
SS-2 (subslab NE, 422 E. 28th St.)	Not measured	1,100
SS-3 (subslab, 420 E. 28th St.)	Not measured	220

Groundwater had detectable but very low PCE and chloroform (**Table 3-6**), although the data are suspect because of the qualifiers related to the very low levels of analytes in the sample. **Table 3-7** shows that the soils analyzed were predominantly sandy and alkaline.

Table 3-6. Groundwater Screening Data

Sample ID	Concentration (ng/mL)			
	Chloroform		PCE	
MW-1A-1	1.9	BU	0.61	BU
MW-1A-4	2.2	BU	0.60	BU
MW-1B-1	2.9	U	0.61	BU
MW-1B-2	2.8	U	0.49	BU
MW-1B-3	3.0	U	0.53	BU
MW-1B-4	2.8	U	0.46	BU
B - ng of analyte detected in sample is not greater than 10 times the ng of analyte detected in the method blank				
U - ng of analyte detected in the sample is below the lowest calibration curve concentration of 25 ng				
Method blank	0.26		0.37	

Table 3-7. Soil Analysis from MW-1 Boring at Multiple Depths

Sample ID	Field Moisture %	pH	Carbon and Nitrogen Analysis		Pipette Particle Size Analysis				% C Removed in Particle Size Pretreatment (organic carbon)
			% Nitrogen	% Carbon (inorganic)	% Sand	% Silt	% Clay	Total %	
TO-97 7-10 ft	11.58	8.18	0.032	5.156	83.97	14.22	1.81	100	0.3233
TO-97 10-12 ft	17.49	8.26	0.027	6.021	79.39	17.59	3.01	100	0.2255
TO-97 12-15 ft	14.21	8.33	0.029	6.033	78.22	19.25	2.52	100	0.1976
TO-97 15-17 ft	17.55	8.45	0.023	3.726	96.35	2.96	0.69	100	0.1124

3.1.6 Initial Conceptual Site Model

The initial conceptual site model for this structure was that a vapor intrusion source was most likely present in shallow and subslab soil gas due to historical dry cleaning facilities and adjacent commercial uses. Radon impacts were suspected because Marion County, Indiana, is in EPA's Zone 1—highest risk for radon. Detectable concentrations of chlorinated hydrocarbons were detected during initial site screening and responded to depressurization of the structure by fans.

The source of VOCs observed at this duplex was initially suspected to be transport of contaminants either

- through a groundwater pathway from upgradient dry cleaners or
- released into the shallow vadose zone during the operations of the adjacent commercial quadraplex.

Later discussions also suggested that an additional potential source is likely disinfection by-products in city drinking water.

3.2 Building Renovation

3.2.1 HVAC Refurbishment and Operations

Because project objectives included evaluating the effects of a central heater and air conditioners, we wished to use the 420 side of the duplex as a “control” without heating, and because the house had been extensively vandalized, Edward’s Electric was hired to install new ductwork with a new gas-fired forced hot air HVAC unit on the 422 side only. The furnace ran initially from November 19, 2010, until June 22, 2011, and then again from November 19, 2011, until June 1, 2012. The system is illustrated in **Figures 3-11** through **3-13**.



Figure 3-11. Basement supply register in newly installed HVAC system.

Window-mounted AC units were initially installed in two upstairs windows on both the 422 and 420 sides of the house. However, thieves broke into the house, stealing the initial four AC units on July 12 and 15, 2011. After a security system upgrade, two replacement AC units were installed in two of the 422 upstairs windows. Therefore, during the summer of 2011 there were periods when:

- both sides of the duplex were cooled with air AC (June 29, 2011, until July 12, 2011),
- neither side of the duplex was cooled with AC (before June 29, 2011, and after July 15, 2011, until August 3, 2011), and
- the 422 side was cooled but the 420 side was not (August 3, 2011, until October 24, 2011).

Part of the intent behind using this formerly vacant house is that we could operate it under nearly normal residential conditions without having to consider the residents or consumer product-related sources, because there were none. These conditions allowed us to control the environment (avoiding indoor sources of contaminants, adjusting environmental conditions at will, adding data collection devices, etc.) without having to consider occupant permission, inconvenience, or potential tampering. The house environment was kept as residents might keep it, but an ARCADIS operative was only on-site during the work week, with occasional weekend work, as opposed to full-time occupancy.

Because of its age, the 422/420 duplex building envelope is particularly leaky. However, every effort was made at the beginning of the project to further the simulation that this was a normal house. We endeavored to make any repairs necessary to put the house in a state similar to one in which an actual resident of limited means would live. Any holes made by vandals in pipes or walls were sealed with foam (Great Stuff) or medium density flat (MDF) board, with enough time before sampling began to allow for drying and ventilation. When holes were made to install wiring, SGPs, MWs, gas chromatography (GC) tubing, or any utility meant for this project, we attempted to seal openings so there was no additional air communication between normally partitioned areas. New ductwork was installed with the new HVAC on the 422 side, so there were no unusual air leaks between floors. Some ductwork is partially in place on the 420 side but not connected. A new front door on the 422 side was installed in an attempt to minimize leakage. But no attempt was made to go beyond what a normal homeowner would normally do. As a result, the heated/cooled side maintained a moderate temperature in the high 60s/low 70s (Fahrenheit) in the winter, and high 70s/low 80s (Fahrenheit) in the summer.

Despite these repairs, potential air entry points still exist as in any home, especially of the age of this duplex. These entry points could include the edges of any of the windows or doors, exposed brick work, and cracks (**Figures 3-14** and **3-15**). In the basement, entry could be through bricks in the basement walls, potentially through cracks in the cement floor, and possibly through the sewer lateral in the floor.



Figure 3-14. Floor cracks in 422 basement, central area, contrast enhanced.



Figure 3-15. Weathered cement in walls and floor cracks in 422, contrast enhanced.

3.2.2 Plumbing Refurbishment and Sealing

Initially in early to mid-2010 before sampling, the house had a strong odor of sewage. Two causes were located and addressed well before sampling began:

- A hole was found on the top of a sewer drain line running horizontally along the basement ceiling. It was taped and later foamed to seal it.
- A vagrant had used an upstairs toilet despite the lack of running water in the house or visible water in the toilet. This issue was addressed by adding a large quantity of kitty litter (bentonite). This measure appeared to solve the odor issue.

However, a decision was made that complete repair of the plumbing system of the home was not necessary for the project purposes and would be costly.

On approximately March 31, 2011, a sewer gas odor was detected in the residence that had not been previously noted. The likely source was dried-out traps in the water pipes. Olfactory observations suggested that the primary source of sewer gas infiltration was a floor drain (**Figure 3-16**), and the drain was initially covered with a metal plate as a temporary measure.

There are many circumstances in occupied houses that allow openings for sewer gas infiltration. It seems that it is relatively common for home inspectors to encounter them during property transactions. Entrance of VOCs through sewer lines is a widely recognized aspect of the vapor intrusion problem.

At that time, all sewer and water connections were surveyed, and several were sampled with passive Radiellos from March 14, 2011 to April 21, 2011. The only VOC results of potential significance came from a drain in the 422 kitchen, likely used as a washer drain. After this sampling, on May 10, 2011, all open lines were sealed, some with both bentonite and cement plugs.

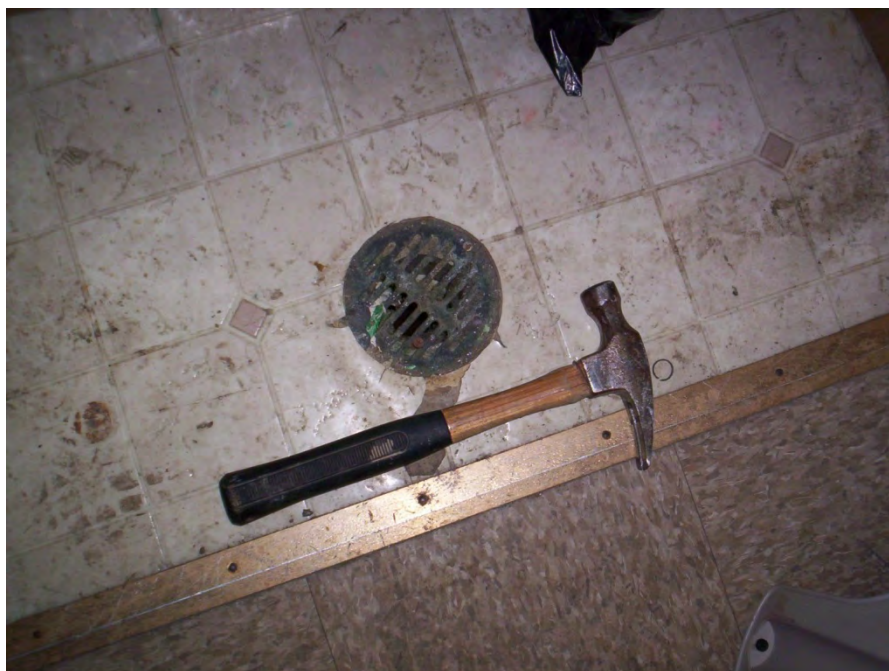

Figure 3-16. Floor drain, 422, 1st floor laundry area.

3.3 Monitoring Infrastructure Installation (Wells, SGPs, Embedded Temperature Sensors)

The monitoring systems were installed in three main phases. The first phase occurred in April 2010, during which a few SGPs (SGP1A, SGP1B, SGP1C), SSPs, and MWs (MW-1A, MW-1B) were installed to check for evidence of vapor intrusion in initial site selection using a hollow stem auger for the MWs and geoprobe for the SGPs. The second took place August 30 to September 1, 2010, using a geoprobe and included all additional exterior SGPs and MWs (e.g., **Figure 3-17**). The last phase began at the same time as the second phase and included all interior ports and wells and all monitoring sensors, but it took longer because of difficulties penetrating the soil layers beneath the structure with the equipment that could be used to work in the fairly confined basement. The interior port installation was started with hand auguring equipment, but, because of the difficulty involved, rock coring equipment was finally used to complete all interior SGPs, water, and sensor wells.



Figure 3-17. Nested monitoring well 1 and SGP1 are located immediately south of the 422 side front wall. SGP1-16.5 and MW-1A is by the wall, to the left of the sign. SGP1-9 and 1-13 as well as MW-1C are by the wall, to the right of the sign (next to the pile of bricks). SGP1-3.5 and 1-6, and MW-1B are in the installation visible in the center foreground.

Figure 3-18 shows the exterior monitoring locations, and **Figure 3-19** shows the interior monitoring locations. The installed monitoring network includes the following:

- Seven groundwater monitoring wells. Two three-well clusters (MW-1 and MW-2, at 16 to 21 ft, 21 to 24 ft, and 24 to 26 ft) were installed with a hollow stem auger and 2-inch PVC casings. MW-3, which was installed in the basement and completed on the first floor, is 1 inch in diameter and has a screen depth between 13.4 and 18.4 ft bls.
- Seven external soil gas locations, 5 depths each (3.5, 6, 9, 13, 16.5 ft bls), designated SGP1 through SGP7. These locations were installed with a geoprobe with 6-inch stainless steel screens completed to the surface with 1/4-inch OD Teflon.
- Five internal (basement) soil gas locations, 4 depths each (6, 9, 13, 16.5 ft bls) designated SGP8 through SGP12.
- Seven conventional subslab locations, designated SSP-1 through SSP-7
- Four basement wall ports (WPs), designated WP-1 through WP-4. These ports were constructed as is typical for SSPs except they were drilled horizontally into the basement wall approximately 2.5 ft above the basement floor.

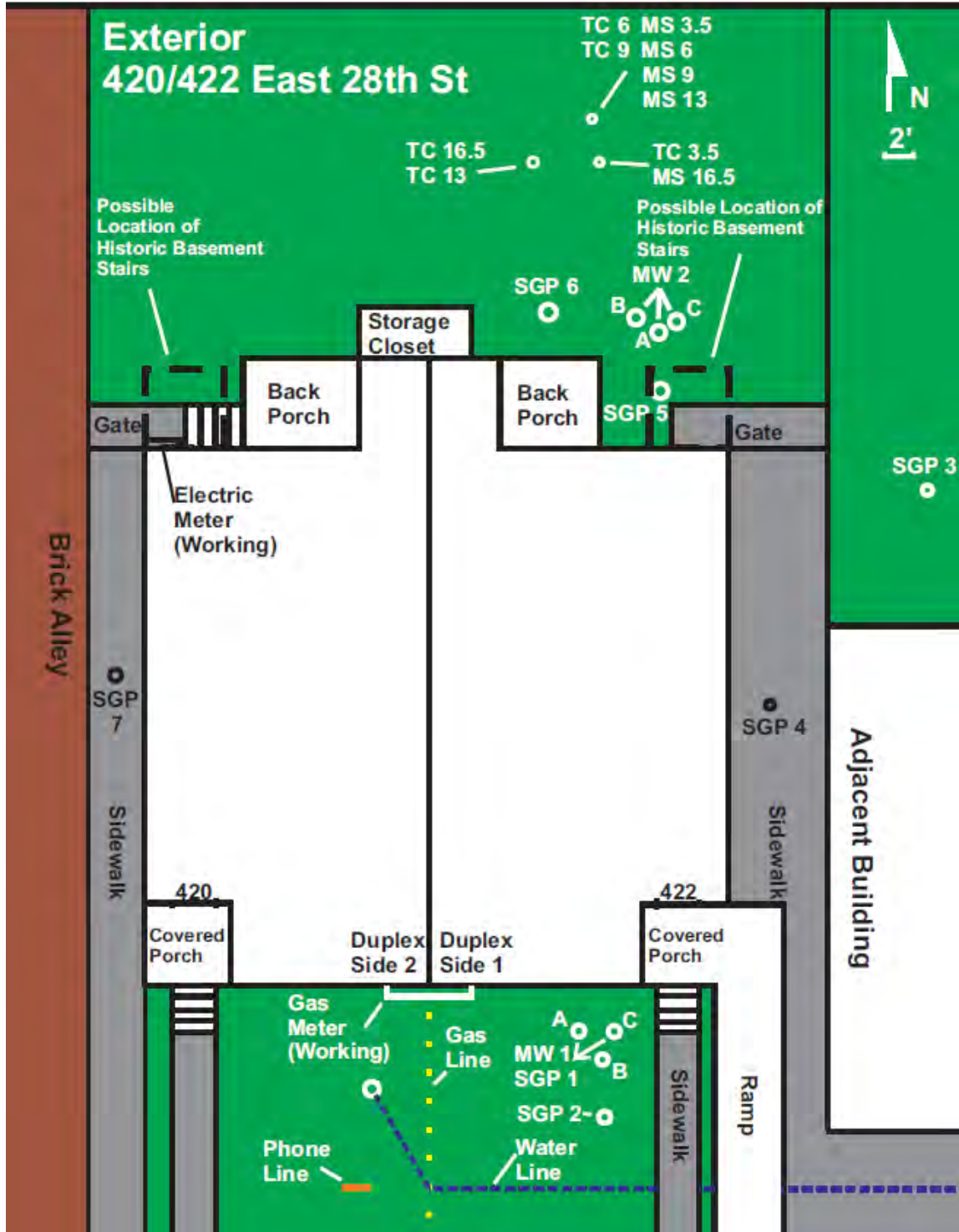

Figure 3-18. Exterior of test building showing utility corridors, ground surface cover, monitoring wells (MWs), soil gas points (SGPs), thermocouples (TCs), and moisture sensors (MSs).

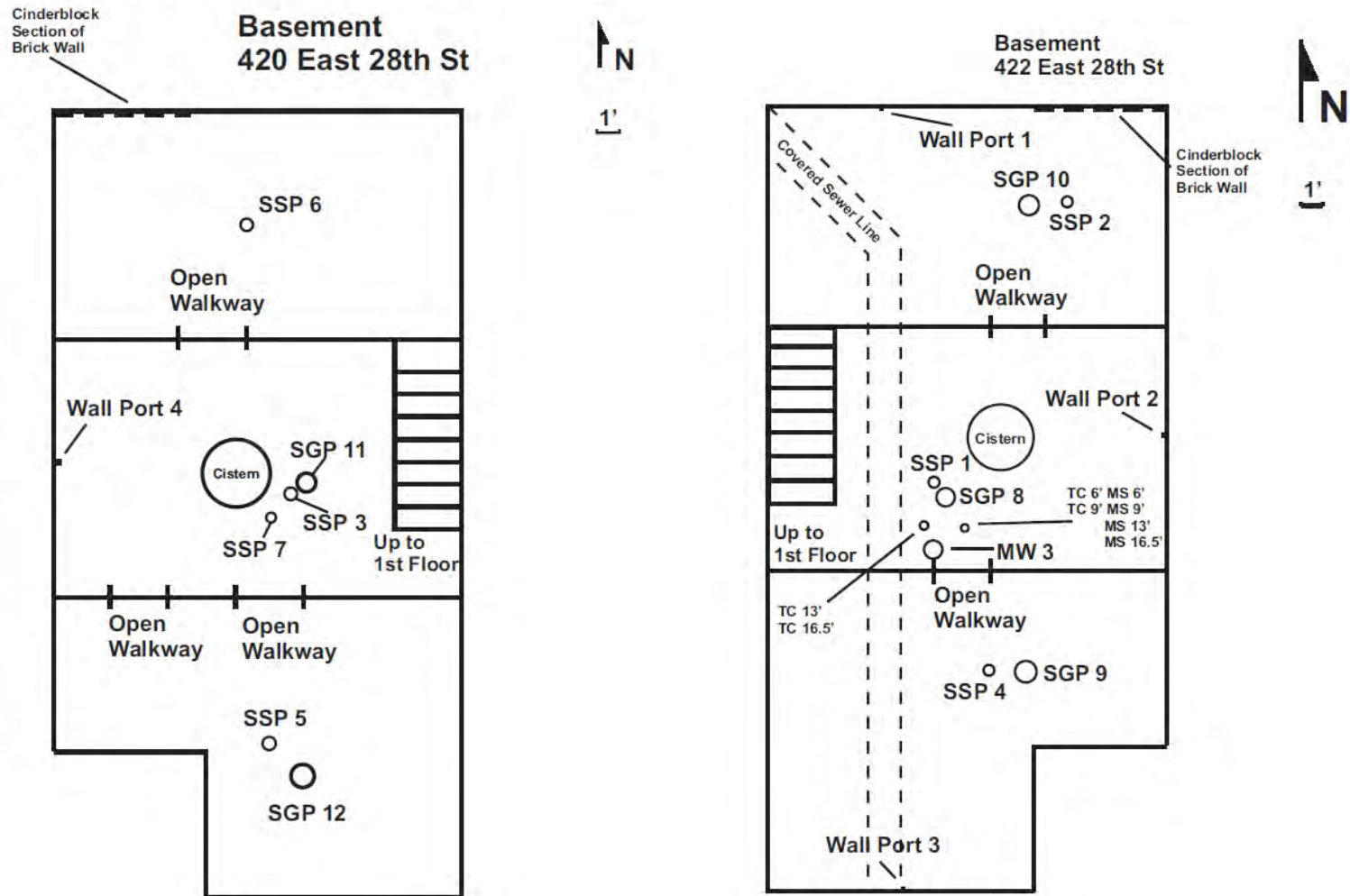

Figure 3-19. Interior floor plans of 420 and 422 East 28th Street showing sampling locations.

Example subslab, soil gas, and wall ports are shown in **Figures 3-20** and **3-21**.



Figure 3-20. Interior SGP9 (top) and SSP-4 (bottom).



Figure 3-21. Wall port 2.

3.4 VOC Sampling and Analysis

3.4.1 Indoor (Passive, Summa Canister)

The overwhelming majority of the indoor passive sampling was done with Radiello 130s supplied by and analyzed by Air Toxics Ltd. For comparison two different types of SKC badges were also used that were specifically adapted to use at very short or long sampling durations. Some indoor air data were taken with Summa canisters during the fan testing.

For passive sampling, several racks were set up to facilitate arranging groups of samplers in consistent locations for different durations during the run of the project. These racks were ordinary laundry drying racks that can be purchased inexpensively at most department stores (**Figure 3-22**). The racks were ideal in that they allowed multiple samplers to be placed at the same, or similar, levels within the normal breathing zone. One rack was placed in each of the following locations on both the 422 and 420 sides (six total): first floor center room, northern basement room, and southern basement room.



Figure 3-22. Passive indoor air sampling rack: 422 first floor.

At each rack, a specific location was assigned for one of several durations: 7, 14, 28, 91, 182, and 364 days, each approximately 6 inches apart to minimize the potential for starvation effects. Enough spaces on the rack remained for duplicates of those durations, plus special locations occupied during intensive rounds. SKC badges were primarily hung on the back portion of the racks, in a similar manner to the Radiellos.

In addition to these indoor racks, a special ambient location had to be made to accommodate the samplers. A hood was purchased to house the samplers and was mounted on a telephone pole by the alley near the house (**Figure 3-23**). This hood housed all of the Radiellos and badges for the different day durations.



Figure 3-23. Ambient sampler shelters on telephone pole near duplex.

Sampling of Radiellos consisted of removing the white diffusive body from its backing shield, opening the glass vial that contained the new screened Radiello 130 and allowing it to slide into the white body, then the white body was replaced in its backing plate with a new sample number. The old one was then sealed in a glass vial for shipping. Each week, Radiellos of the appropriate durations were stopped and replacements were started. For example, when the 7- and 14-day Radiellos were stopped, new ones were put up in their places. The 7-day samples were taken down the following week, followed by the 14-day samples the week after. This arrangement allowed us to compare the results of different time durations to each other (e.g., four weekly samples against the monthly for the same time period). Additionally, during some of the intensive rounds, daily Radiellos were taken to compare them to the weekly time increments.

SKC 575 badges with the secondary diffusion cover were used for comparing longest Radiello durations (the 182- and 364-day time periods). These solvent-extracted charcoal badges have been used in the literature for durations of 4 weeks and longer. SKC Ultra Badges (thermally desorbed) were used for 24-hour and 7-day sampling during an intensive round and short-term sampling during a fan test. Both Radiellos and SKC badges were provided by and returned to Air Toxics Ltd. for analysis.

Summa canisters (6-L, Method TO-15) were used for preliminary site screening, indoor air sampling before and after the fan testing (Section 12.1), and for a study comparing temporary and permanent subslab ports (Section 12.1). These canisters were acquired from and returned to Air Toxics Ltd. for analysis. This project did not include an extensive comparison of Summa canisters to passive samplers (for example Radiello) because numerous such comparisons have been performed by others (see discussion in Section 2.1.4).

3.4.2 Subslab and Soil Gas (TO-17 and Summa Canister)

The primary method of subslab and soil gas sampling for VOCs was by TO-17. In this method, a thermo-desorption tube, with a female Swagelok end, was connected to each sampling port in turn. Each port had its own male union connected to a valve. Before sampling, the port was purged with an SKC Universal XR pump set to 1L/min. To ensure that the soil gas sample represented soil gas and not the air in the sampling line, five well volumes were purged via an exhaust line that ran away from the operator for exterior ports or out of a basement window in the case of the interior ports. The fittings were attached with wrenches, and an airtight syringe was mounted onto the other end of the TO-17 tube. When these steps were complete, the port's valve was opened, and the syringe was used to draw 200 mL of air through the TO-17 tube over a period of a minute. Then the port valve was closed, and the TO-17 tube was removed and sealed for shipping.

Samples were taken from operational ports at no less than three depths each week. Initially, the preferred depths to sample were 3.5, 9, and 16.5 ft bls exterior and 6, 9, and 16.5 ft bls interior. However, a higher than expected water table prevented the sampling of the 16.5-ft depths for most of the duration of the project. Unusually high water tables or perched/infiltrating water occasionally made other SGPs inoperative. In addition, all wall ports were sampled each week, as well as a subset of the SSPs.

The majority of the TO-17 tubes collected were prepared and analyzed by the EPA National Exposure Research Laboratory (NERL). For the extensive sampling of the intensive rounds, additional TO-17 tubes were prepared and analyzed by Air Toxics. An intercomparison study of the two TO-17 laboratories was conducted (see Section 4.2.4 of this report). During the intensive rounds, all functioning ports (not made inoperative by water) were sampled at least once each day of the round. For a few days of each round, several locations were sampled multiple times of the day with the intention of comparing hourly and daily variability to the normal weekly variability.

Some soil gas samples were acquired with Summa canisters (Method TO-15) during the initial site screening before the start of the main project. These samples were taken from the earliest of the drilled subslabs and SGPs (e.g., SSP-1, SGP1). Also, Summa canisters were used to obtain soil gas during the temporary versus permanent subslab SGP special study (see Section 12.1 for a description of this special study).

3.4.3 Online Gas Chromatograph

The GC was provided and overseen by Dr. Blayne Hartman of Hartman Environmental Geoscience. They used an electron capture detector (ECD, EPA Method 8021) and had 16 available sampling channels controlled sequentially by a multipoint stream selection valve. The channels were distributed as follows:

- One was initially connected to the nitrogen tank but later was connected to a line to outdoor air (about 4 ft from the house) in order to provide an ambient air comparison.
- One was connected to a trichloroethylene (TCE) standard periodically.
- Two were blanks used to clear the instrument after each run.
- There were 12 sample channels: four indoor air, three subslab probes, one wall port, three house-interior soil gas probes, and one house-exterior soil gas probe.

All sampling lines were constructed of 1/16-inch OD stainless steel tubing (except the 420 first floor line that has about a 20-ft section of 1/8-inch OD stainless steel tubing at the sampling end). The different diameters of tubing were based on available materials and were not expected to have any significant impact on the operability of the system. The tubing for all lines ran from a multipoint stream selector valve at the GC along interior walls to the sampling points. At the sample locations, the indoor air lines hung suspended over passive sampler racks within the breathing zone. For SGPs and SSPs, each tube was connected to a sampling port by means of appropriate Swagelok male/female fittings. Lines for sampling were brought to atmospheric pressure before sampling and were sampled for 30 to 60 seconds in each cycle.

When connected to the GC by the selector valve, the sampling point would be open for the GC to sample but was closed when the switching valve was connected to another sampling point. The system has a sample injection valve with an adsorbent trap or 1-cc sample loop, uses computerized data acquisition with PeakSimple software, and can take approximately nine samples per location per day. Blayne Hartman had constant access to the GC via a Wi-Fi connection installed at the house for instrument monitoring. The GC was in operation at the 422/420 house from August 11, 2011, to October 17, 2011, and again from December 1, 2011, to February 2, 2012. We checked for carryover with port 14 in the sequence (either a TCE calibration standard or system blank). Port 13 was the last port of a series of high-concentration PCE and chloroform SGPs. Port 14 (and later ports 15 and 16 as well) were thus used to monitor for the possibility of carryover before returning the cycle to port 1-5 for the indoor air analyses.

The tubing from each sample location was connected to the stream selector valve. At any time, one of the entering tubes was connected to the adsorbent trap or sample loop depending on the position of the stream selector valve. A low-flow vacuum pump would draw the vapor sample through the tubing at a rate of 25 cc/min to 40 cc/minute for 30 to 90 seconds to purge the sample tubing and ensure the sample in the sample loop was from the selected sample location. When purging was complete, the sample injection valve would rotate and inject the sample into the GC for analysis. Cycle time from start of purging to the end of the analysis was approximately 10 minutes. When the analysis was complete, the stream selector valve would advance to the next position (next sample location) and the process would repeat itself. This sequence would continue uninterrupted until stopped by the operator.

In the first phase of the automated program (August 2011 to October 2011), the vapor sample from each location was concentrated onto an adsorbent trap. Volumes passed over the trap were adjusted depending on the vapor concentration at each location and ranged from 20 cc to 80 cc. Higher sample volumes were collected on the trap for lower concentration locations such as indoor air. Lower sample volumes were used for soil gas.

In the second phase of the program (December 2011 to February 2012), the adsorbent trap was eliminated and the sample was passed through a 1-cc sample loop for direct injection into the GC. This modification was made to minimize carry-over between the high-concentration soil gas samples and the low-concentration indoor air samples and to speed up the analysis.

3.4.4 Groundwater

Groundwater samples were taken approximately monthly with permeable diffusion bags (PDBs) from EON Products Inc. The 422/420 duplex has six exterior MWs (two clusters of three) and one single-depth interior well installed in the basement and completed on the first floor (**Figure 3-24**). The exterior wells are arranged in groups of three in the front and the back yards. Each group of three is divided into depths of 16 to 21 ft, 21 to 24 ft, and 24 to 26 ft bls. The interior well (MW-3) is about 18 ft bls, but the casing extends up to the first floor for ease of access, so it is about 24 ft deep at its access point. The exterior wells are 2 inches in diameter, and the internal well is 1 inch in diameter. PDBs for the exterior wells are 12 by 1.75 inches, and the interior is 18 by 0.75 inches. PDBs were deployed for at least 2 weeks, and a new set of PDBs was cycled through almost monthly. PDBs were filled initially with deionized water provided by the EPA NERL laboratory. Groundwater samples were shipped to EPA for VOC analysis by Methods 5030/8260.



Figure 3-24. Monitoring well MW-3, installed in the basement and completed on the first floor.

3.5 Radon Sampling and Analysis

3.5.1 Indoor Air Radon Sampling and Analysis

The primary radon sampling method was electrets ion chambers collecting radon samples passively in indoor air for the same 7-day intervals as Radiello-collected VOCs. The following secondary methods were, however, also used for radon in indoor air:

- stationary alphaguards at two locations to provide greater time resolution,
- carbon absorbers for a quality control (QC) comparison, and
- consumer-grade ionization chamber-based detector (Safety Siren Pro Series 3 manufactured by Family Safety Products Inc.) for comparison.

Each method is described in detail below.

Rad Elec, E-Perm, ST-type (short-term) electrets were used according to EPA 402-R-92-004 (U.S. EPA, 1992). These electrets were primarily deployed in s-chambers, but h-chambers were used on a few occasions. To sample, electrets were opened within their chambers at their assigned locations for a week (or a day during intensive rounds). After a week, the chambers were closed, all electrets were allowed to equilibrate for an hour to the room temperature where they would be read, and then their voltages were read on a Rad-Elec electret voltage reader. Start and stop times, as well as voltages, were recorded and the electrets redeployed. The voltages, configurations (e.g., ST electrets in s-chambers), dates, and times would then be incorporated into a calculation used to convert voltage to pCi/L, with background gamma correction.

The electrets reader was calibrated weekly with three standards. In addition, an electret blank test was run weekly to test for effects of the chamber on the electrets. In this test, an electret not used during the sampling was inserted into one of the used electret chambers (closed) and then read to determine whether there had been any voltage drop from the previous week's reading.

Initially, one electret was hung in a mesh bag from each of the passive sampler racks each week (plus one duplicate at one location). Additionally, an electret was also housed in the ambient sampler hood, but that electret was stolen. The ambient electret location was then switched to a nearby tree, but that electret was also stolen. Finally, the ambient electret was kept in a permeable bag and hung from a hook about 2 ft from the house. This location proved to be ideal. On December 28, 2011, a new electret was added in the 422 second floor office to be used in conjunction with the radon siren testing.

Charcoal canisters from the U.S. EPA Radiation and Indoor Environments (R&IE) National Laboratory were set out on the sampling racks on three separate occasions to check the accuracy of the electret readings (U.S. EPA, 1990). They were simply opened for a week (matching an electret sampling period), closed, and shipped back to EPA for testing. Section 3.5.3 discusses the stationary Alphaguards that were also used on the project for indoor air radon measurement.

A consumer-grade radon detector (safety siren testing) was a late-stage addition to the project. Six Pro Series 3 safety siren radon gas detectors were deployed on December 23, 2011, and were in use until the last electret readings were taken on March 1, 2012. Each was installed at one of six locations: 422 second floor office, 422 first floor center room, 422 basement south, 422 basement north, 420 first floor center room, and 420 basement south. The intention of the test was to determine the agreement among the radon sirens, electrets, stationary alphaguards, and (for 1 week) charcoal canisters. The sirens can be read once each week, so their readings were taken when the other data types were being acquired and their readings compared.

3.5.2 Subslab and Soil Gas Radon Sampling and Analysis

Radon readings were collected approximately weekly (and daily during intensive rounds) with a portable Alphaguard Professional Radon Monitor from Genitron instruments. Operations were based on EPA guidelines for using continuous radon monitors (U.S. EPA, 1992). More information on the Alphaguard can be found at www.genitron.de/products/products.html. During normal weekly sampling, this device was connected to subslab, soil gas, and wall ports with an SKC Universal XR pump set to 1 L/min. Tubes connected the sample port to the pump (with a moisture filter on the sampling end) and the pump to the Alphaguard. A purge line led away from the operator for exterior sampling and out of basement windows for interior sampling locations. The Alphaguard requires a 10-minute cycle of uninterrupted air flow from the sample location for an accurate reading. Because a certain amount of time was needed for movement between, one 10-minute cycle was spent relocating and then another to sample at the next location. Thus, each sample port needed 20 minutes to sample.

Because radon has a short half-life (3.8 days) and the migration time from substantial depths for soil gas is estimated to be months to years (Kurtz and Folkes, 2008; Carr et al., 2011), radon sampling focused on the shallowest depths and, therefore, differed from the VOC sampling strategy. Exterior sampling consisted of the shallowest soil gas ports available of the wells closest to the house. Usually, these ports were the 3.5 and 6-ft deep ports of SGP1, 7, 4, and 5. Periodically, these depths would not yield a sample, presumably due to moisture infiltration. In such cases, the next shallowest depths were chosen. Routine interior sampling included all wall ports, five of the SSPs, and the shallowest intervals of the nested interior SGPs. When sampling during the intensive weeks, all locations were sampled multiple times, and some locations were sampled more than once per day.

For normal weekly sampling, first an ambient reading was taken outdoors and approximately 20 ft away from the 422/420 house. Then, lines to be sampled would be purged with the SKC pump (five soil gas point volumes, calculated based on the depth). Finally, the pump would be connected to the Alphaguard to acquire a full 10-minute sample.

The Alphaguard has a readout screen that details the results of the analysis at the end of each 10-minute cycle. The data provided are Rn (Bq/m^3), relative humidity (%), pressure (mbar), and temperature ($^{\circ}\text{C}$). These data were recorded each week in a spreadsheet and the Bq/m^3 converted to pCi/L.

3.5.3 Continuous (Real-Time) Indoor Air Radon Sampling and Analysis

The real-time Alphaguards are essentially the same as the hand-held Alphaguard instrument used to sample from the SGPs, except they are not fitted with the same nozzle type, because they are not connected to external pumps. Rather, in this application they are operated in a diffusion mode. These Alphaguards are intended to be placed to give readings in specific rooms. In the case of the 422/420 duplex, one unit was placed in the 422 second floor office, and the other was placed in the 422 North basement area. These units stayed in their locations, except for brief, periodic data downloadings. These units were first regularly deployed on March 31, 2011, and were in near-continuous operation for 1 year.

The data are produced by the instrument in the same units as the portable Alphaguard (requiring conversion to pCi/L) and data points are collected every 10 minutes. However, because these devices were not moved, all 10-minute cycles are usable. The real-time Alphaguards are used in conjunction with Data Expert software, also from Genitron Instruments. Once each week, the Alphaguards were connected to the computer (the one in the basement required briefly moving the instrument to download), and the software downloaded the readings for the week. These data were then saved as text files for later conversion to Excel spreadsheet files.

3.6 Physical Parameters Monitoring

3.6.1 On-Site Weather Station

This project used a Davis Vantage Vue Weather Station on-site with Weather Link data logger and software (**Figure 3-25**). The components consist of the outdoor monitoring unit, the indoor receiver, and the computer connection. The outdoor monitoring unit was mounted on an accessible portion of the 422/420 house roof. The unit was mounted on steel pipes, but 5 ft above the highest roof deck (that of the attic dormer).

The outdoor unit contains all the exterior monitoring equipment (for example, wind speed cups, rain gauge) and has a solar panel/battery backup for power. The outdoor unit transmits a radio signal to the indoor receiver, which also records the data every half hour. The indoor unit is human readable and can also be used to set a variety of parameters. The indoor unit also records the house interior data at its location, in this case the 422 second floor office. Once each week, the data were downloaded from the

indoor unit onto the computer containing the Weather Link software. These data were saved as a text file and later compiled in an Excel spreadsheet file. Many parameters are recorded; the key ones required for this project are temperature (° F, interior and exterior), relative humidity (percent), wind speed (miles per hour), and wind direction (16 points [22.5 degrees] on compass rose).

Initially, and at least every 6 months, the results from this on-site system were compared with other nearby weather stations in Indianapolis using at least 1 day's observations. The National Weather Service (NWS) Indianapolis International Airport (KIND) is approximately 15 miles southwest from site. The Indianapolis NWS station at Eagle Creek Airpark (KEYE) is approximately 9 miles west of the site. There is also a private weather station available online closer to the site in Indianapolis, IN (KININDIA33).



Figure 3-25. Front view of 420/422 duplex with location of weather station sensors indicated with red arrow.

3.6.2 Indoor Temperature

Although the indoor weather station unit can record temperature, it only does so in the 422 second floor office where it is located. Because temperature readings were required at all sample locations to allow adjustment of the passive sampler data for uptake rate variation due to temperature, another form of data collection was necessary. HOBOS data loggers, made by Onset (<http://www.onsetcomp.com/>), were placed one at each of the six passive sampler racks in the house. HOBOS record temperature (° F) and relative humidity (percent) every 30 minutes. Once a week, these data were recorded by taking them to the computer with the HOBOWare reading software and later importing those data to an Excel spreadsheet file. Special spreadsheets were created to provide this information for the different Radiello time durations to the passive sampler analytical laboratory.

3.6.3 Soil Temperature

Soil temperature was recorded by thermocouples from Omega (Type T, Hermetically Sealed Tip Insulated Thermocouples, HSTC-TT-T-24S-120). During the initial house setup, holes were drilled beneath the basement slab and backyard soils of the duplex to accommodate thermocouple probes with end points set at different depths. Wires were inserted in approximately 2-inch diameter holes with weights loosely attached near the ends. The holes were allowed to cave in and backfill naturally. The thermocouple wires run from their holes to male/female connectors (sealed from the elements in rubber “boots”) and from there to a data acquisition system (PDAQ 56 by IOtech), where the data were recorded to the software on the computer. A reading was taken approximately every 15 minutes. The thermocouples wired to the PDAQ roughly corresponded to the depths of the SGPs: inside at 6, 9, 13, and 16.5 ft bls; outside at 1, 3.5, 6, and 13 ft bls. However, there is one thermocouple (outside 16.5 ft) that is wired into an Omega data logger (OM-EL-USB-TC). The thermocouple data were most typically collected at 15-minute intervals.

3.6.4 Soil Moisture

Soil moisture was recorded by implanted Watermark moisture sensors. The units of measurement for the soil moisture sensors are explained by Smajstrla and Harrison (2002):

Water potential is commonly measured in units of bars (and centibars in the English system of measurement) or kilopascals (in metric units). One bar is approximately equal to one atmosphere (14.7 lb/in²) of pressure. One centibar is equal to one kilopascal. Because water is held by capillary forces within unsaturated soil pore spaces, its water potential is negative, indicating that the water is under tension and that work must be done to extract water from the soil. A water potential reading of 0 indicates that the soil is saturated, and plant roots may suffer from lack of oxygen. As the soil dries, water becomes less available and the water potential becomes more negative. The negative sign is usually omitted for convenience when soil water potentials are measured.

The soil water matrix potential can be converted into volumetric water content using known equations. Moisture content is often measured in fixed laboratories as gravimetric water content. To convert gravimetric water content to volumetric water, multiply the gravimetric water content by the bulk specific gravity of the material.

These sensors were also installed in the holes drilled during the house setup. Before insertion, the sensors had to be presoaked in water to prepare them. The sensors are pill-shaped devices at the end of a wire. The wire was run up through a PVC pipe of the appropriate length for the depth and the wire grasped manually. The sensor could then be placed to the appropriate depth within the hole, the PVC pipe withdrawn, and the soil backfill allowed to fill in naturally. Wires extend to the Watermark 900M monitor, which reads and records the data every 30 minutes. Once each week these data were downloaded

to the Watergraph 3.1 software on the computer. Data were recorded in centibars. The sensors were installed to approximately correspond to the SGP depths: inside at 6, 13, and 16.5 ft bls and outside at 3.5, 6, 9, 13, and 16.5 ft bls.

3.6.5 Potentiometric Surface/Water Levels

Water levels in the seven wells on-site (two outdoor three-well clusters and a single well in the basement) were taken periodically with a Solinst water-level meter. The water-level results were compared against U.S. Geological Survey (USGS) stream gauge data for Fall Creek at Millersville, site 03352500 near the house.

3.6.6 Differential Pressure

Differential pressure readings were monitored by Setra Model 264 low differential pressure transducer. These units contain a pressure-sensitive diaphragm that measures pressure changes from the exterior high/low poles. The poles had tubing connected that ran from the areas to be measured. Some Setra poles were left open as an interior reference at a particular location. The configurations on the 422 side were as follows: subslab versus basement, basement versus upstairs, deep soil gas versus shallow soil gas, and basement versus exterior (out of the basement window). Only one unit was located on the 420 side, and it was used for subslab versus basement. Three lines used SGPs as access points: 422 deep soil gas versus shallow soil gas used SGP8-6 and SGP8-13; 422 subslab versus basement used SSP-1; and 420 subslab versus basement used SGP11-9. When these locations had to be sampled for VOCs, the ports would be closed, disconnected from the Setras, purged, and sampled. Afterward, the ports would be reconnected to the Setras and opened again.

The four Setras on the 422 side of the house are wired into the Personal Measurement Device, PMD-1208LS from Measurement Computing. The PMD is connected to the computer and uses TracerDaq software. Readings are taken every 15 minutes. The one Setra on the 420 side is connected to the PDAQ device and also takes a reading every 15 minutes (but not necessarily the same 15-minute interval as the PMD Setras).

In the beginning of the project, the Setras were laid flat on their supporting surfaces. In February 2011, manufacturer's guidance was found indicating that they should be mounted vertically. The manufacturer stated that correcting for the different mounting could be done by blocking the poles in the horizontal position to determine their "zero readings" and then record those same readings in the vertical position to determine the offset. The offset could then be factored in to change the horizontal position data to vertical. By March 31, 2011, all were hung in this manner, and the early data corrected.

3.6.7 Air Exchange Rate

To determine the air exchange rate, capillary adsorption tubes (CATs) were used in conjunction with para-dimethylcyclohexane (PDCH) and para-methylcyclohexane (PMCH) emitters, provided by the Harvard School of Public Health (HSPH) (EPA Method IP-4). The emitters are small metal shells containing a fluid (either PDCH or PMCH), and the shells are contained within a foam wrapping. The fluid releases a tracer gas at a measured constant rate, which is picked up by the CATs when in place. One stopper end of the CAT is removed when the samplers were deployed for periods of 1 week to allow sampling of the tracer gas by the adsorbent medium.

On April 22, 2011, in the 422 side of the house, 10 of the PDCH emitters were placed in the basement, 10 PMCH emitters were placed on the first floor, and nine PMCH emitters were placed on the second floor. Care was taken that emitters be placed far enough from each other and from walls (about 3 to 4 ft). The placement locations also allowed unrestricted air flow.

CATs were used for sampling for air exchange rate measurement on two occasions. The first was from April 27, 2011, to May 4, 2011, and the second was from September 23, 2011, to September 29, 2011. On the first occasion, CATs were deployed: one on the 422 first floor (center room) and two in the 422 basement (one duplicate). One was also placed in 420 on the first floor (center room) and in the 420 basement (center room). On the second occasion, CATs were only deployed on the 422 side of the house. One was in the 422 office on the second floor, one on the first floor (center room), and two were placed in the basement center room (one duplicate). When sampling, CATs were placed on their sides with one cap removed and slightly tipped at one end so the open end pointed toward the ground. After sampling, the CATs were sealed and sent to HSPH for analysis.

3.6.8 Crack Monitoring

The basement floors and walls were visually inspected for significant cracks (i.e., ones where vapors could infiltrate from subsurface soils). For the three most significant cracks, a calibrated crack monitor (**Figure 3-26**) was installed across the crack. This device consists of two plates that move independently. One plate is white with a black millimeter grid; the other is transparent with red crosshairs centered over the grid. When the monitor is secured with epoxy or screws across a crack, the crosshairs shift vertically or horizontally on the grid, making crack movement easily visible and trackable. It was installed with a 5-Minute® Epoxy, a rapid-curing, general-purpose adhesive that bonds rigid, durable substrates such as metals, glass, ceramics, concrete, and wood in all combinations. The position of the monitor was recorded monthly and indicated that the monitored cracks did not move during the course of the study.



BEN MEADOWS Calibrated Crack Monitor

Figure 3-26. Calibrated crack monitor.

Table of Contents

4.	Results and Discussion: Quality Assurance Checks of Individual Data Sets.....	4-1
4.1	VOC Sampling—Indoor Air-Passive—Air Toxics Ltd. (ATL)	4-1
4.1.1	Blanks.....	4-1
4.1.2	Surrogate Recoveries.....	4-3
4.1.3	Laboratory Control Sample Recoveries	4-3
4.1.4	Duplicates.....	4-3
4.2	VOC Sampling—Subslab and Soil Gas (TO-17)—U.S. EPA	4-4
4.2.1	Blanks.....	4-4
4.2.2	Surrogate Recoveries.....	4-7
4.2.3	Laboratory Control Sample Recoveries	4-7
4.3	VOC Sampling—Subslab and Soil Gas (TO-17)—ATL	4-8
4.3.1	Blanks.....	4-8
4.3.2	Surrogate Recoveries.....	4-10
4.3.3	Laboratory Control Sample Recoveries	4-11
4.3.4	Duplicates.....	4-11
4.4	VOC Sampling—Subslab and Indoor Air (TO-15)—ATL	4-12
4.4.1	Blanks.....	4-12
4.4.2	Surrogate Recoveries.....	4-13
4.4.3	Laboratory Control Sample Recoveries	4-13
4.4.4	Duplicates.....	4-14
4.5	Online GC (Soil Gas and Indoor Air).....	4-14
4.5.1	Blanks.....	4-14
4.5.2	Initial Calibration	4-15
4.5.3	Continuing Calibration.....	4-15
4.5.4	Calibration Check via Comparison to Fixed Laboratory (TO-15 vs. Online GC)	4-15
4.5.5	Agreement of Online GC Results with TO-17 Verification Samples	4-16
4.5.6	Agreement of Integrated Online GC Results with Passive Samplers.....	4-18
4.6	Radon.....	4-25
4.6.1	Indoor Air: Comparison of Electrets Field, ARCADIS to Charcoal Analyzed by U.S. EPA R&IE National Laboratory	4-25
4.6.2	Comparison of Average of Real Time Alphaguard to Electrets and Charcoal Canisters	4-28
4.6.3	Quality Assurance Checks of Electrets	4-30
4.7	On-Site Weather Station vs. National Weather Service (NWS).....	4-31
4.8	Database	4-33
4.8.1	Checks on Laboratory Reports	4-33
4.8.2	Database Checks	4-34

List of Figures

4-1.	Correlation between radon measured using the electret and charcoal methods.....	4-27
4-2.	Aerial view of study house, showing potential influences on wind velocity, red arrow indicates study house.	4-32
4-3.	Comparison of National Weather Service Indianapolis temperature data to weather station at 422 East 28th Street.....	4-32
4-4.	Comparison of National Weather Service Indianapolis relative humidity to weather station at 422 East 28th Street.....	4-33

4-5. Comparison of National Weather Service wind speed data to weather station at 422 East 28th Street.....4-33

List of Tables

4-1. Indoor Air Passive Field Blank Summary—Radiello 130.....4-1

4-2. Indoor Air Passive Trip Blank Summary—Radiello 1304-2

4-3. Indoor Air Passive Laboratory Blank Summary—Radiello 1304-2

4-4. Indoor Air Passive Surrogate Summary—Radiello 130.....4-3

4-5. Indoor Air Passive LCS Summary—Radiello 1304-3

4-6. Indoor Air Passive Laboratory Precision (LCS/LCSD) Summary—Radiello 130.....4-4

4-7. Subslab and Soil Gas—EPA Field Blank Summary—TO-174-5

4-8. Subslab and Soil Gas—EPA Trip Blank Summary—TO-174-6

4-9. Subslab and Soil Gas—EPA Laboratory Blank Summary—TO-17.....4-6

4-10. Subslab and Soil Gas—EPA Fridge Blank Summary—TO-174-7

4-11. EPA TO-17 Surrogate Recovery Summary4-7

4-12. EPA TO-17 LCS Summary4-8

4-13. Subslab and Soil Gas—ATL Field Blank Summary—TO-174-9

4-14. Subslab and Soil Gas—ATL Trip Blank Summary—TO-174-10

4-15. Subslab and Soil Gas—ATL Lab Blank Summary—TO-17.....4-10

4-16. ATL TO-17 Surrogate Recovery Summary.....4-11

4-17. ATL TO-17 LCS Summary4-11

4-18. ATL TO-17 Laboratory Precision (LCS/LCSD) Summary.....4-12

4-19. Subslab and Indoor Air—ATL Lab Blank Summary—TO-15.....4-13

4-20. ATL TO-15 Surrogate Recovery Summary.....4-13

4-21. ATL TO-15 LCS Summary4-14

4-22. ATL TO-15 Laboratory Precision (LCS/LCSD) Summary.....4-14

4-23. Interlaboratory Results: Spiked Verification Samples.....4-17

4-24. Interlaboratory Statistics: Spiked Verification Samples4-18

4-25. Comparison of Online GC to Radiello Results.....4-19

4-26. Comparison between Electrets and Charcoal Canisters at the 422/420 EPA House from January 19–26, 20114-26

4-27. Comparison of Electret and Charcoal Canister Data from April 27, 2011, to May 4, 2011.....4-26

4-28. Comparison of Charcoal and Electret Radon December 28, 2011, to January 4, 2012.....4-27

4-29. Comparison between 422 Base N Alphaguards and Electrets from March 30, 2011, and May 18, 20114-28

4-30. Comparison of Real-Time Alphaguard to Integrated Electret August through October4-28

4-31. Comparison of Real-time Alphaguards to Integrated Electret Measurements December 28, 2011 to January 4, 2012.....4-29

4-32. Comparison of Real-time Alphaguard to Integrated Electret Measurements January through March.....4-30

4. Results and Discussion: Quality Assurance Checks of Individual Data Sets

4.1 VOC Sampling—Indoor Air-Passive—Air Toxics Ltd. (ATL)

4.1.1 Blanks

Field blanks, trip blanks, and laboratory blanks were used to evaluate false positives and/or high bias due to transport, storage, sample handling, and sorbent contamination. Field blanks were collected using a blank Radiello 130 cartridge from the media sample batch sent to the field from the laboratory. The cartridge was removed from the sealed storage vial and transferred to the diffusive housing in a similar manner to sample deployment. The cartridge was then immediately removed from the housing, returned to the storage vial, and sealed for shipment back to the laboratory with the field samples. In general, a field blank was collected with each shipment to the laboratory. A total of 47 field blanks were submitted over the duration of the project.

Blank Radiello cartridges from the media batches were also assigned as trip blanks. The cartridge was not opened or removed from the storage vial but was sent back to the laboratory along with the field samples. There were 22 trip blanks submitted for analysis.

In the case of the laboratory blank, a Radiello 130 cartridge was extracted with each analytical batch to measure background from the sorbent and the extraction process. A total of 72 unique laboratory blanks were analyzed and reported over the duration of the project.

To assist in data interpretation, all blank samples and all field sample results were evaluated down to the method detection limit (MDL). The results of the field, trip, and laboratory blanks are summarized in **Tables 4-1, 4-2, and 4-3**. The number of blanks with detections above the reporting limit (RL) and MDL are tabulated. Summary statistics were then calculated on this subset of positive detections.

Table 4-1. Indoor Air Passive Field Blank Summary—Radiello 130

	RL(µg)	Number of Field Blanks			% of Field Blanks with Detections	Mean Blank Conc. (µg)	Std Dev (µg)	Min (µg)	Max (µg)
		Analyzed	Conc. > RL	RL > Conc. > MDL					
Benzene	0.4	47	0	38	81%	0.11	0.042	0.040	0.18
Chloroform	0.1	47	0	0	0%	NA	NA	NA	NA
cis-1,2-DCE	0.1	47	0	0	0%	NA	NA	NA	NA
Hexane	0.1	47	4	9	28%	0.099	0.091	0.033	0.35
PCE	0.1	47	0	2	9%	0.032	0.020	0.0067	0.049
Toluene	0.1	47	1	21	47%	0.040	0.036	0.014	0.17
TCE	0.1	47	0	5	11%	0.015	0.0093	0.0064	0.031

NA = Not applicable

Benzene was detected above the MDL but below the RL in a majority of the field, trip, and lab blanks at similar background levels. The average of the positive detections was 0.11, 0.10, and 0.12 µg for the field, trip, and lab blanks, respectively. The benzene blank levels are largely due to benzene contamination present in the carbon disulfide extraction solvent. Although the laboratory used high purity (99.99%) carbon disulfide reagent, benzene is present as a common contaminant in this solvent.

Table 4-2. Indoor Air Passive Trip Blank Summary—Radiello 130

	RL(μg)	Number of Trip Blanks			% of Trip Blanks with Detections	Mean Blank Conc. (μg)	Std Dev (μg)	Min (μg)	Max (μg)
		Analyzed	Conc. > RL	RL > Conc. > MDL					
Benzene	0.4	22	0	20	91%	0.10	0.039	0.042	0.16
Chloroform	0.1	22	0	0	0%	NA	NA	NA	NA
cis-1,2-DCE	0.1	22	0	0	0%	NA	NA	NA	NA
Hexane	0.1	22	0	10	45%	0.049	0.012	0.036	0.07
PCE	0.1	22	0	2	9%	0.015	0.009	0.0087	0.022
Toluene	0.1	22	0	18	82%	0.020	0.008	0.012	0.041
TCE	0.1	22	0	4	18%	0.024	0.0159	0.0094	0.043

NA = Not applicable

Table 4-3. Indoor Air Passive Laboratory Blank Summary—Radiello 130

	RL(μg)	Number of Lab Blanks			% of Lab Blanks with Detections	Mean Blank Conc. (μg)	Std Dev (μg)	Min (μg)	Max (μg)
		Analyzed	Conc. > RL	RL > Conc. > MDL					
Benzene	0.4	73	0	67	92%	0.12	0.043	0.039	0.22
Chloroform	0.1	73	0	0	0%	NA	NA	NA	NA
cis-1,2-DCE	0.1	73	0	0	0%	NA	NA	NA	NA
Hexane	0.1	73	0	18	25%	0.053	0.019	0.034	0.083
PCE	0.1	73	0	2	3%	0.0081	0.00042	0.0078	0.0084
Toluene	0.1	73	0	52	71%	0.025	0.014	0.012	0.064
TCE	0.1	73	0	4	6%	0.022	0.0068	0.013	0.027

NA = Not applicable

Although the benzene background levels were below the RL, a positive bias is expected for the daily Radiello and a large subset of the weekly indoor air samples. Longer duration samples would normally collect more mass and, thus, would not be significantly affected. The mass of benzene adsorbed by the sorbent cartridge over 1 day averaged 0.19 μg , similar to the levels detected in the blanks. For the weekly samples, the average mass measured on the cartridge was 0.62 μg ; however, approximately half of the weekly samples contained benzene levels that were less than 5 times the blank levels. Sample deployment times greater than a week demonstrated less positive bias from the blank because proportionally more benzene mass was collected by the diffusive sampler from the indoor air environment.

Hexane and toluene were also commonly detected in the field, trip, and lab blanks above the MDL. In the case of the field blanks, several had concentrations above the RL for hexane and toluene. All detections in the trip and lab blanks were below the RL but above the MDL. Similar to benzene, a positive bias for hexane and toluene is anticipated for the daily Radiello samples due to the blank levels. The average mass collected on the sorbent for the daily passive samples was 0.11 and 0.19 μg for hexane and toluene, respectively. A positive bias is expected for hexane for the weekly samples as well with average sample mass collected of 0.44 μg . Blank levels of toluene are not significant when evaluating the weekly samples because the mass collected is generally greater than 10 times blank levels. Longer duration samples would normally collect more mass and thus would not be significantly affected.

No detections of chloroform or cis-1,2-dichloroethene (cis-1,2-DCE) were measured in any of the blanks. For a small percentage of the blanks, low concentrations detections above the MDL were measured for tetrachloroethene (PCE) and trichloroethene (TCE).

4.1.2 Surrogate Recoveries

To monitor extraction efficiency, 5.0 µg of toluene-d8 was spiked into each field sample and quality control (QC) sample Radiello 130 cartridge immediately prior to extraction. The recoveries were evaluated against laboratory limits of 70 to 130%. All surrogate recoveries met the laboratory criterion, and summary statistics are presented in **Table 4-4**.

Table 4-4. Indoor Air Passive Surrogate Summary—Radiello 130

Parameter	Result
Number of surrogate recoveries measured	1,255
Average recovery (%R)	102.8
Standard deviation (%R)	5.9
Minimum recovery (%R)	87
Maximum recovery (%R)	122

4.1.3 Laboratory Control Sample Recoveries

Accuracy of the extraction and analysis step for the target compounds was evaluated by analyzing a laboratory control sample (LCS). An unused Radiello cartridge was spiked with a standard containing 5.0 µg of each compound of interest. The laboratory acceptance criterion for LCS recovery was 70 to 130%. All LCS recoveries met the control limits of 70 to 130%, and summary statistics are presented in **Table 4-5**.

Table 4-5. Indoor Air Passive LCS Summary—Radiello 130

	Number of LCS Analyzed	Mean LCS % Recovery	LCS Std Dev (%R)	Min (%R)	Max (%R)
Benzene	73	93	11.0	71	116
Chloroform	73	96	11.5	70	122
cis-1,2-DCE	73	95	8.7	72	121
Hexane	73	101	14.6	71	130
PCE	73	98	9.8	73	125
Toluene	73	94	9.8	73	117
TCE	73	97	8.6	73	118

4.1.4 Duplicates

Sample precision was evaluated by collecting field duplicates and by analyzing laboratory control sample duplicates (LCSDs). Field duplicates were collected for approximately every 10 field samples, and an LCSD was prepared and analyzed with each sample preparation batch. Because the LCSD was a second cartridge prepared and extracted in the same manner as the LCS, the relative percentage difference (%RPD) represents the precision of the analytical method from extraction through analysis. The method precision is summarized in **Table 4-6**. The laboratory acceptance criterion of %RPD < 25% was met for all compounds except for benzene in two analytical batches and hexane in five analytical batches.

Table 4-6. Indoor Air Passive Laboratory Precision (LCS/LCSD) Summary—Radiello 130

	Number of LCSD Analyzed	Mean %RPD	Std Dev. (%RPD)	Min (%RPD)	Max (%RPD)	Number of Exceedances
Benzene	73	9%	8%	0%	29%	2
Chloroform	73	10%	7%	0%	25%	0
cis-1,2-DCE	73	5%	4%	0%	19%	0
Hexane	73	11%	9%	0%	37%	5
PCE	73	5%	4%	0%	19%	0
Toluene	73	5%	4%	0%	19%	0
TCE	73	5%	4%	0%	14%	0

4.2 VOC Sampling—Subslab and Soil Gas (TO-17)—U.S. EPA

4.2.1 Blanks

Field, trip, refrigerator, and laboratory blanks were used to evaluate false positives and/or high bias due to transport, storage, sample handling, and sorbent contamination. Field blanks were collected using a blank Tenax TA TO-17 sorbent tube from the media sample batch sent to the field from the laboratory. The Swagelok end caps were removed as if to prepare for sample collection; however, no soil vapor was pulled through the tube. The end caps were immediately replaced, and the tube was sent back to the laboratory with the field samples. Typically, a field blank was collected with each shipment to the laboratory. A total of 98 field blanks were submitted over the duration of the project.

Blank Tenax TA TO-17 sorbent tubes from the media batches were also assigned as trip blanks. The tube remained capped and wrapped in aluminum foil and was sent from the laboratory to the field and back to the laboratory along with the field samples. There were 85 trip blanks submitted for analysis.

In the case of the laboratory blank, a Tenax TA TO-17 tube was analyzed with each analytical batch to measure background from the sorbent tubes and instrumentation. A total of 251 lab blanks were analyzed and reported over the duration of the project.

For a refrigerator (fridge) blank, a Tenax TA TO-17 tube was stored and analyzed with each sample batch to measure background from the sample storage refrigerator. The tubes were stored in the refrigerator, capped, and sealed in a zippered bag on top of the jars containing the samples that were received as a batch. The fridge blanks were placed in the refrigerator with a sample batch and remained in the refrigerator with the batch until all the samples from that batch had been analyzed. Thus, the fridge blanks were in the refrigerator longer than some of the samples within a batch. A total of 48 fridge blanks were analyzed and reported over the duration of the project.

To assist in data interpretation, all blank samples and all field sample results were evaluated down to the MDL. The results of the field, trip, laboratory, and fridge blanks are summarized in **Tables 4-7, 4-8, 4-9, and 4-10**. The number of blanks with detections above the RL and MDL are tabulated. Summary statistics were then calculated on this subset of positive detections.

Benzene was detected above the MDL in 54%, 42%, 39%, and 46% of the field, trip, laboratory, and fridge blanks, respectively. The average of the positive detections was 1.4, 1.2, 1.7, and 1.2 nanogram (ng) for the field, trip, lab, and fridge blanks, respectively. Six laboratory blanks had benzene concentrations above the RL of 5.0 ng. The benzene blank levels are largely due to background

contribution from the Tenax TA polymer, which can break down during the heating step to generate low levels of benzene.

The concentrations of benzene in the TO-17 soil vapor samples were similar in magnitude to those measured in the field blanks. Of the 2,270 TO-17 soil vapor samples analyzed by EPA, 73% of the samples had a positive detection of benzene. Of the samples that had a positive detection for benzene, only 2% had a detected concentration above the RL of 5.0 ng. The second most common contaminant in these blank samples was toluene, which has also been reported as a Tenax breakdown product (MacLeod and Ames, 1986; Cao and Hewitt, 1994).

Detections of the key compounds that form the focus of this work—PCE, chloroform, and TCE—occurred in 6% of the samples or less of the hundreds of the field trip and lab blanks analyzed. However, the percentage of refrigerator blanks with PCE and TCE contamination was considerably higher—19%.

Table 4-7. Subslab and Soil Gas—EPA Field Blank Summary—TO-17

	RL (ng)	MDL (ng)	Number of Field Blanks			% of Field Blanks with Detections	Mean Blank Conc. (ng)	Std. Dev. (ng)	Min (ng)	Max (ng)
			Analyzed	Conc. > RL	RL> Conc. > MDL					
Benzene	5.0	0.87	98	0	53	54	1.4	0.5	0.81	3.0
Carbon disulfide	5.0	0.48	98	0	9	9	3.4	1.4	1.7	6.4
Chloroform	2.0	0.76	98	5	0	5	72	110	3.0	260
cis-1,2-DCE	2.0	0.85	98	0	1	1	1.5	NA	1.5	1.5
Hexane	10	0.44	98	0	2	2	1.6	1.5	2.2	4.4
Methylene chloride	50	0.60	98	0	4	4	6.4	3.8	2.5	11
PCE	2.0	1.3	98	1	1	1	2.8	NA	2.8	2.8
Toluene	5.0	1.2	98	0	11	11	1.3	0.3	1.1	1.9
TCE	2.0	1.2	98	3	0	3	14	1.1	13	16

NA = Not applicable

Table 4-8. Subslab and Soil Gas—EPA Trip Blank Summary—TO-17

	RL (ng)	MDL (ng)	Number of Trip Blanks			% of Trip Blanks with Detections	Mean Blank Conc. (ng)	Std. Dev. (ng)	Min (ng)	Max (ng)
			Analyzed	Conc. > RL	RL> Conc. > MDL					
Benzene	5.0	0.87	85	0	36	42	1.2	0.5	0.81	2.6
Carbon disulfide	5.0	0.48	85	0	9	11	2.6	0.8	1.6	4.0
Chloroform	2.0	0.76	85	4	1	6	42	45	2.0	120
cis-1,2-DCE	2.0	0.85	85	0	0	0	0	0	0	0
Hexane	10	0.44	85	0	2	2	2.0	1.5	1.0	3.0
Methylene chloride	50	0.60	85	0	4	5	2.8	0.8	2.2	4.0
PCE	2.0	1.3	85	4	0	5	18	11	2.3	27
Toluene	5.0	1.2	85	3	13	19	3.6	4.8	1.0	19
TCE	2.0	1.2	85	2	0	2	3.7	2.0	2.3	5.2

Table 4-9. Subslab and Soil Gas—EPA Laboratory Blank Summary—TO-17

	RL (ng)	MDL (ng)	Number of Lab Blanks			% of Lab Blanks with Detections	Mean Blank Conc. (ng)	Std. Dev. (ng)	Min (ng)	Max (ng)
			Analyzed	Conc. > RL	RL> Conc. > MDL					
Benzene	5.0	0.87	251	6	92	39	1.7	1.6	0.80	12
Carbon disulfide	5.0	0.48	251	4	42	18	9.6	9.2	0.87	52
Chloroform	2.0	0.76	251	7	2	4	2.1	0.33	1.3	2.5
cis-1,2-DCE	2.0	0.85	251	0	0	0	0	0	0	0
Hexane	10	0.44	251	0	4	2	4.8	2.9	1.8	8.7
Methylene chloride	50	0.60	251	0	6	2	3.0	1.3	5.6	2.4
PCE	2.0	1.3	251	0	1	0.4	1.8	NA	1.8	1.8
Toluene	5.0	1.2	251	2	29	12	7.4	6.0	1.0	8.1
TCE	2.0	1.2	251	3	2	2	7.4	6.0	1.4	16

NA = Not applicable

Table 4-10. Subslab and Soil Gas—EPA Fridge Blank Summary—TO-17

	RL (ng)	MDL (ng)	Number of Fridge Blanks			% of Fridge Blanks with Detections	Mean Blank Conc. (ng)	Std. Dev. (ng)	Min (ng)	Max (ng)
			Analyzed	Conc. > RL	RL>Conc . > MDL					
Benzene	5.0	0.87	48	0	22	46	1.2	0.40	0.81	1.8
Carbon disulfide	5.0	0.48	48	0	2	4	2.3	0.69	1.8	2.8
Chloroform	2.0	0.76	48	2	0	4	2.3	0.29	2.1	2.5
cis-1,2-DCE	2.0	0.85	48	0	0	0	0	0	0	0
Hexane	10	0.44	48	0	3	6	1.0	0.08	0.88	1.0
Methylene chloride	50	0.60	48	0	4	8	6.1	7.5	1.8	17
PCE	2.0	1.3	48	6	3	19	3.7	1.6	2.0	3.5
Toluene	5.0	1.2	48	4	8	25	10	23	0.96	82
TCE	2.0	1.2	48	8	1	19	7.4	4.6	1.5	17

4.2.2 Surrogate Recoveries

To monitor analytical efficiency, 5.3 ng of bromochloromethane were loaded onto each QC and field sample sorbent tube along with the vapor phase internal standard mix during sample analysis. Field surrogates were not included in the scope of this project. The recoveries were evaluated against laboratory limits of 70 to 130%. Most surrogate recoveries met the laboratory criterion, and summary statistics are presented in **Table 4-11**.

Table 4-11. EPA TO-17 Surrogate Recovery Summary

Parameter	Result
Number of surrogate recoveries measured	3,370
Average recovery (%R)	105
Standard deviation (%R)	14
Minimum recovery (%R)	27
Maximum recovery (%R)	354

4.2.3 Laboratory Control Sample Recoveries

Analytical accuracy was evaluated by analyzing an LCS. Two clean Tenax TA TO-17 sorbent tubes were spiked with a calibration standard from a source independent from the primary calibration standard and analyzed after each initial calibration. The spike contained approximately 100 ng of each target compound. The performance of the EPA TO-17 LCS spikes is summarized in **Table 4-12**. A total of 10 LCS samples were evaluated, and all met the laboratory RLs with the exceptions of five outliers for carbon disulfide, four outliers for methylene chloride, and one outlier for cis-1,2-DCE.

Table 4-12. EPA TO-17 LCS Summary

	Number of LCS Analyzed	Mean LCS % Recovery	LCS Std Dev (%R)	Min (%R)	Max (%R)	LCS Recovery Limits	Number of Exceedances
Benzene	10	101	11	86	118	70 – 130%	0
Carbon disulfide	10	117	64	24	272	70 – 130%	5
Chloroform	10	96	11	82	122	70 – 130%	0
cis-1,2-DCE	10	105	10	96	133	70 – 130%	1
Hexane	10	98	11	72	120	70 – 130%	0
Methylene chloride	10	111	71	29	291	70 – 130%	4
PCE	10	85	8.1	71	97	70 – 130%	0
Toluene	10	102	13	80	128	70 – 130%	0
TCE	10	100	12	80	120	70 – 130%	0

4.3 VOC Sampling—Subslab and Soil Gas (TO-17)—ATL

4.3.1 Blanks

Field blanks, trip blanks, and laboratory blanks were used to evaluate false positives and/or high bias due to transport, storage, sample handling, and sorbent contamination. Field blanks were collected using a blank Tenax TA TO-17 sorbent tube from the media sample batch sent to the field from the laboratory. The Swagelok end caps were removed to prepare for sample collection; however, no soil vapor was pulled through the tube. The end caps were immediately replaced, and the tube was sent back to the laboratory with the field samples. Typically, a field blank was collected with each shipment to the laboratory. A total of 18 field blanks were submitted over the duration of the project.

Blank Tenax TA TO-17 sorbent tubes from the media batches were also assigned as trip blanks. The tube remained capped and wrapped in aluminum foil and was sent back to the laboratory along with the field samples. There were five trip blanks submitted for analysis.

In the case of the laboratory blank, a Tenax TA TO-17 tube was analyzed with each analytical batch to measure background from the sorbent tubes and instrumentation. A total of 26 lab blanks were analyzed and reported over the duration of the project.

To assist in data interpretation, all blank samples and all field sample results were evaluated down to the MDL. The results of the field, trip, and laboratory blanks are summarized in **Tables 4-13, 4-14, and 4-15**. The number of blanks with detections above the RL and MDL are tabulated. Summary statistics were then calculated on this subset of positive detections.

Benzene was detected above the MDL in all of the field blanks and a majority of the trip and lab blanks. The average of the positive detections was 3.0, 3.4, and 2.1 ng for the field, trip, and lab blanks, respectively. Two field blanks had benzene concentrations above the RL of 5.0 ng. The benzene blank levels are largely due to background contribution from the Tenax TA polymer, which can break down during the heating step to generate low levels of benzene.

The concentrations of benzene in the TO-17 soil vapor samples were similar in magnitude to those measured in the field blanks. Of the 382 TO-17 soil vapor samples analyzed by ATL, 93% of the samples

had a positive detection of benzene. The average benzene sample mass measured was 3.6 ng with a standard deviation of 2.1 ng, a minimum concentration of 1.2 ng, and a maximum concentration of 15 ng.

Methylene chloride was detected at levels above the RL for a set of five field blanks collected on December 15, 2011. These field blanks had concentrations above the RL of 50 ng with an average concentration of 90 ng and concentrations ranging from 68 to 130 ng. Similar levels of methylene chloride were measured in the samples collected over December 11, 2011, to December 15, 2011, and a positive bias for these sets of samples is expected.

For the chlorinated compounds of concern (chloroform, cis-1,2-DCE, PCE, and TCE), the mean blank concentrations were typically less than one-half the RL, and sample detections above the RL are not expected to exhibit a significant positive bias based on the blank levels.

Table 4-13. Subslab and Soil Gas—ATL Field Blank Summary—TO-17

	RL (ng)	Number of Field Blanks			% of Field Blanks with Detections	Mean Blank Conc. (ng)	Std Dev (ng)	Min (ng)	Max (ng)
		Analyzed	Conc. > RL	RL > Conc. > MDL					
Benzene	5.0	18	2	16	100%	3.0	1.6	1.5	6.9
Carbon disulfide	5.0	18	2	7	50%	5.5	5.0	1.4	14
Chloroform	2.0	18	0	14	78%	0.76	0.50	0.37	1.9
cis-1,2-DCE	2.0	18	1	0	6%	2.8	NA	2.8	2.8
Hexane	10	18	1	6	39%	4.3	4.1	0.78	12
Methylene chloride	50	18	5	0*	28%	90	26	68	130
PCE	2.0	18	0	0	0%	NA	NA	NA	NA
Toluene	5.0	18	2	4	33%	3.7	2.4	0.53	6.6
TCE	2.0	18	0	11	61%	0.44	0.090	0.28	0.60

NA = Not applicable

* Not all blanks were reported to the MDL.

Table 4-14. Subslab and Soil Gas—ATL Trip Blank Summary—TO-17

	RL (ng)	Number of Trip Blanks			% of Trip Blanks with Detections	Mean Blank Conc. (ng)	Std Dev (ng)	Min (ng)	Max (ng)
		Analyzed	Conc. > RL	RL > Conc. > MDL					
Benzene	5.0	5	0	4	80%	3.4	0.86	2.4	4.5
Carbon disulfide	5.0	5	1	3	80%	2.6	2.5	1.2	6.3
Chloroform	2.0	5	0	0	0%	NA	NA	NA	NA
cis-1,2-DCE	2.0	5	0	0	0%	NA	NA	NA	NA
Hexane	10	5	0	2	40%	1.3	0.42	1.0	1.6
Methylene chloride	50	5	0	3*	60%	14	6.2	7.4	19
PCE	2.0	5	0	1	20%	0.73	NA	0.73	0.73
Toluene	5.0	5	1	1	40%	4.2	4.9	0.72	7.6
TCE	2.0	5	0	2	40%	0.88	0.31	0.66	1.1

NA = Not applicable

* Not all blanks were reported to the MDL.

Table 4-15. Subslab and Soil Gas—ATL Lab Blank Summary—TO-17

	RL (ng)	Number of Lab Blanks			% of Lab Blanks with Detections	Mean Blank Conc. (ng)	Std Dev (ng)	Min (ng)	Max (ng)
		Analyzed	Conc. > RL	RL > Conc. > MDL					
Benzene	5.0	26	0	15	58%	2.1	0.46	1.4	2.8
Carbon disulfide	5.0	26	0	12	46%	2.1	0.81	1.0	3.9
Chloroform	2.0	26	0	11	42%	0.56	0.29	0.34	1.4
cis-1,2-DCE	2.0	26	0	4	15%	0.66	0.50	0.35	1.4
Hexane	10	26	0	2	8%	0.90	0.42	0.60	1.2
Methylene chloride	50	26	0	4*	15%	3.5	4.3	1.3	9.9
PCE	2.0	26	0	2	8%	0.34	0.20	0.20	0.48
Toluene	5.0	26	0	4	15%	0.62	0.46	0.32	1.3
TCE	2.0	26	0	7	27%	0.48	0.073	0.35	0.57

NA = Not applicable

* Not all blanks were reported to the MDL.

4.3.2 Surrogate Recoveries

To monitor analytical efficiency, 36 ng of bromofluorobenzene were loaded onto each QC and field sample sorbent tube along with the vapor phase internal standard mix during sample analysis. Field surrogates were not included in the scope of this project. The recoveries were evaluated against laboratory limits of 70 to 130%. All surrogate recoveries met the laboratory criterion, and summary statistics are presented in **Table 4-16**.

Table 4-16. ATL TO-17 Surrogate Recovery Summary

Parameter	Result
Number of surrogate recoveries measured	510
Average recovery (%R)	100.6
Standard deviation (%R)	7.5
Minimum recovery (%R)	77
Maximum recovery (%R)	119

4.3.3 Laboratory Control Sample Recoveries

Analytical accuracy was evaluated by analyzing an LCS. A clean Tenax TA TO-17 sorbent tube was spiked with a calibration standard from a source independent from the primary calibration standard and analyzed with each analytical batch. The spike typically contained approximately 50 to 150 ng of each target compound. The performance of the ATL TO-17 LCS spikes is summarized in **Table 4-17**. A total of 25 LCS samples were evaluated, and all met the laboratory RLs with the exception of one outlier for benzene and carbon disulfide and two outliers for hexane.

Table 4-17. ATL TO-17 LCS Summary

	Number of LCS Analyzed	Mean LCS % Recovery	LCS Std Dev (%R)	Min (%R)	Max (%R)	LCS Recovery Limits	Number of Exceedances
Benzene	25	82	7.2	68	97	70–130%	1
Carbon disulfide	25	110	22	72	157	50–150%	1
Chloroform	25	85	5.7	75	96	70–130%	0
cis-1,2-DCE	25	91	6.4	80	105	70–130%	0
Hexane	25	107	15.4	77	136	70–130%	2
Methylene chloride	25	97	15.6	64	127	50–150%	0
PCE	25	81	8.5	70	103	70–130%	0
Toluene	25	81	8.8	70	100	70–130%	0
TCE	25	83	7.1	72	96	70–130%	0

4.3.4 Duplicates

Sample precision was evaluated by collecting field duplicates and by analyzing LCSDs. Field duplicates were collected for approximately every 10 field samples, and an LCSD was analyzed with each sample preparation batch. The LCSD was prepared by analyzing the spiked LCS sorbent tube a second time using the recollection feature of the automated thermal desorption unit. As such, the LCSD provides both verification of the re-collection step as well as an evaluation of instrument precision. The instrument precision is summarized in **Table 4-18**. The laboratory acceptance criterion of %RPD \leq 20% was met for all compounds.

Table 4-18. ATL TO-17 Laboratory Precision (LCS/LCSD) Summary

	Number of LCSD Analyzed	Mean (%RPD)	Std Dev. (%RPD)	Min (%RPD)	Max (%RPD)
Benzene	25	4%	2%	1%	8%
Carbon disulfide	25	3%	3%	0%	11%
Chloroform	25	2%	2%	0%	8%
cis-1,2-DCE	25	2%	2%	0%	7%
Hexane	25	2%	2%	0%	7%
Methylene chloride	25	3%	3%	0%	11%
PCE	25	1%	2%	0%	5%
Toluene	25	2%	2%	0%	8%
TCE	25	1%	1%	0%	4%

4.4 VOC Sampling—Subslab and Indoor Air (TO-15)—ATL

A total of 13 subslab and 13 ambient (indoor and outdoor) air samples were collected in Summa canisters and analyzed by EPA Method TO-15. The subslab samples were analyzed using the laboratory standard TO-15 method with base RLs of 0.5 to 2.0 ppbv. The ambient air samples were analyzed using a more sensitive TO-15 instrument configuration (low-level) with base RLs of 0.1 to 0.5 ppbv.

4.4.1 Blanks

Laboratory blanks were used to evaluate false positives and/or high bias due to laboratory handling and analysis. Lab blanks were prepared by filling a Summa canister with humidified ultra high purity (UHP) nitrogen or zero air and analyzing in the same manner as the field samples. A total of four unique TO-15 lab blanks were analyzed. One was analyzed on the standard TO-15 unit along with the subslab samples. Three were analyzed on the low-level TO-15 units along with the ambient samples. All lab blanks and field sample results were evaluated down to the MDL. The results for the TO-15 lab blanks are summarized in **Table 4-19**.

Detections above the MDL but below the RL were reported for carbon disulfide, PCE, and toluene in the standard TO-15 lab blank. PCE and toluene were reported at less than one-half the RL, and carbon disulfide was slightly higher than one-half the RL. Similar levels of carbon disulfide were detected in the associated subslab samples. Sample detections of PCE and toluene above the RL are not expected to exhibit a positive bias based on the lab blank concentrations.

In the case of the TO-15 low-level analysis, carbon disulfide was detected above the MDL in two of the lab blanks and methylene chloride was detected above the MDL in one of the lab blanks. Associated samples had similar concentrations above the MDL but below the RL.

Table 4-19. Subslab and Indoor Air—ATL Lab Blank Summary—TO-15

	Reporting Limit (µg/m ³)		Laboratory Blank Summary (µg/m ³)			
	Standard	Low Level	Standard	Low Level		
Benzene	1.6	0.32	<1.6	<0.32	<0.32	<0.32
Carbon disulfide	1.6	1.6	0.97	<1.6	0.20	0.23
Chloroform	2.4	0.49	<2.4	<0.49	<0.49	<0.49
cis-1,2-DCE	2.0	0.40	<2.0	<0.40	<0.40	<0.40
Hexane	1.8	0.35	<1.8	<0.35	<0.35	<0.35
Methylene chloride	1.7	0.69	<1.7	0.51	<0.69	<0.69
Tetrachloroethene	3.4	0.68	0.83	<0.68	<0.68	<0.68
Toluene	1.9	0.38	0.38	<0.38	<0.38	<0.38
Trichloroethene	2.7	0.54	<2.7	<0.54	<0.54	<0.54

4.4.2 Surrogate Recoveries

To monitor analytical performance, a vapor-phase surrogate mix was loaded onto the TO-15 concentrator during sample introduction. The three surrogates monitored were 1,2-DCE-d₄, toluene-d₈, and bromofluorobenzene. The spiking level was 25 ppbv for standard TO-15 and 5.0 ppbv for low-level TO-15. The recoveries were evaluated against laboratory limits of 70 to 130%. All sample surrogate recoveries met the laboratory criterion, and summary statistics are presented in **Table 4-20**.

Table 4-20. ATL TO-15 Surrogate Recovery Summary

Parameter	1,2-DCE-d ₄	Toluene-d ₈	Bromofluorobenzene
Number of surrogate recoveries measured	26	26	26
Average recovery (%R)	97	98	97
Standard deviation (%R)	12	1.7	8.2
Minimum recovery (%R)	86	94	89
Maximum recovery (%R)	124	100	114

4.4.3 Laboratory Control Sample Recoveries

Analytical accuracy was evaluated by analyzing an LCS. An LCS working standard was prepared in a Summa canister using a National Institute of Standards and Technology (NIST)-traceable vapor standard independent from the primary calibration standard cylinder. The spiking level was 50 ppbv for the standard TO-15 method and 10 ppbv for the low-level TO-15 analysis. The performance of the ATL TO-15 LCSs is summarized in **Table 4-21**. A total of four unique LCS spikes were evaluated, and all met the laboratory RLs.

Table 4-21. ATL TO-15 LCS Summary

	Number of LCS Analyzed	Mean LCS % Recovery	LCS Std Dev (%R)	Min (%R)	Max (%R)	LCS Recovery Limits
Benzene	4	97	14	78	110	70 – 130%
Carbon disulfide	4	107	14	90	124	70 – 130%
Chloroform	4	97	11	80	105	70 – 130%
cis-1,2-DCE	4	93	10	80	104	70 – 130%
Hexane	4	90	10	76	98	70 – 130%
Methylene chloride	4	85	12	77	102	70 – 130%
PCE	4	95	11	79	104	70 – 130%
Toluene	4	96	13	77	108	70 – 130%
TCE	4	97	10	83	105	70 – 130%

4.4.4 Duplicates

Sample precision was evaluated by collecting field duplicates and by analyzing LCSDs. Field duplicates were collected for approximately every 10 field samples (air samples do not have duplicate samples; only collocated samples), and an LCSD was analyzed with each sample preparation batch. The LCSD was prepared by analyzing the LCS working standard a second time. The instrument precision is summarized in **Table 4-22**. The laboratory acceptance criterion of $\%RPD \leq 25\%$ was met for all compounds.

Table 4-22. ATL TO-15 Laboratory Precision (LCS/LCSD) Summary

	Number of LCSD Analyzed	Mean %RPD	Std Dev. (%RPD)	Min (%RPD)	Max (%RPD)
Benzene	4	2%	3%	0%	7%
Carbon disulfide	4	2%	2%	1%	4%
Chloroform	4	1%	2%	0%	4%
cis-1,2-DCE	4	1%	1%	0%	3%
Hexane	4	1%	1%	0%	1%
Methylene chloride	4	3%	2%	1%	7%
PCE	4	3%	2%	1%	5%
Toluene	4	2%	2%	0%	5%
TCE	4	2%	1%	0%	3%

4.5 Online GC (Soil Gas and Indoor Air)

4.5.1 Blanks

Instrument blanks were analyzed at least once per analysis cycle of the 12 sampling locations. Nitrogen or outdoor air was analyzed at the beginning of the analysis cycle (stream selector valve port #1). System blanks (no vapor sample injected) were analyzed twice per analysis cycle at the end of the analysis cycle (stream selector valve ports #15 and #16).

4.5.2 Initial Calibration

For Phase 1 (August 11, 2011, to October 17, 2011), an initial calibration curve for PCE and chloroform (CHCl_3) was performed at the start of the monitoring program as follows:

- PCE: Two points at concentrations of $13 \mu\text{g}/\text{m}^3$ and $70 \mu\text{g}/\text{m}^3$
- CHCl_3 : A single point at a concentration $10 \mu\text{g}/\text{m}^3$, with a separate linearity study after the initial deployment

Additional calibration points were not possible because of problems with the calibration standards brought to the site during instrument setup. Although these one- and two-point calibrations were less than desired, and they were corrected in the second round (see below), the data from the two sampling phases matched up fairly well, indicating that the limited calibration points in the first round still gave representative data.

For Phase 2 (December 1, 2011, to February 16, 2012), initial calibrations were as follows:

- PCE low range: six points at concentrations from $0.7 \mu\text{g}/\text{m}^3$ to $23 \mu\text{g}/\text{m}^3$
- PCE high range: three points at concentrations from $3.5 \mu\text{g}/\text{m}^3$ to $69 \mu\text{g}/\text{m}^3$
- CHCl_3 low range: four points at concentrations from $3.3 \mu\text{g}/\text{m}^3$ to $55 \mu\text{g}/\text{m}^3$
- CHCl_3 high range: three points at concentrations from $55 \mu\text{g}/\text{m}^3$ to $270 \mu\text{g}/\text{m}^3$

The MDL for the on-site gas chromatograph (GC) was around $1 \mu\text{g}/\text{m}^3$.

4.5.3 Continuing Calibration

Continuing calibration could not be performed using the compounds of interest because the calibration standard could contaminate the indoor air values. Instead, a surrogate compound, TCE, was used for continuing calibration. The TCE was plumbed to stream selector port #14 with the intent it would be analyzed in every analytical cycle of the 16 ports. However, during both phases of the program, the TCE calibration standard ran out inexplicably fast. Several attempts were made to discover the source of the leak and replace the standard, but on each occasion the calibration gas was lost. As an alternative, a calibration check comparing the performance of the field instrument to a laboratory-based instrument with site sample was performed as discussed in the next section.

4.5.4 Calibration Check via Comparison to Fixed Laboratory (TO-15 vs. Online GC)

Verification samples were collected and analyzed by H&P Mobile Geochemistry during each phase as follows.

For Phase 1, an indoor air sample was collected from the 422 1st floor on October 11, 2011, and compared to the on-site instrument to check on the reported concentration values. The results were as follows ($\mu\text{g}/\text{m}^3$):

	On-site GC	H&P TO-15
CHCl_3	1.7	0.8
PCE	3	1.3

In addition, a 24-hour time composite indoor air sample was collected from the 422 first floor and the basement on September 22, 2011, and compared to the on-site instruments values over the same time period to check on the reported low concentration values. The results were as follows ($\mu\text{g}/\text{m}^3$):

	On-site GC	ATL TO-15
<i>422 First floor:</i>		
CHCl ₃	1.0	0.24
PCE	1.75	0.40
<i>422 Basement:</i>		
CHCl ₃	1.7	0.41
PCE	3.5	0.94

Based on these data and the data summarized in Section 4.5.6, we decided that the online GC chloroform low values ($<5 \mu\text{g}/\text{m}^3$) should be adjusted down by a factor of 2 (conservatively) and the online GC PCE low values ($<5 \mu\text{g}/\text{m}^3$) should be adjusted down by a factor of 3.

For Phase 2, a sample was collected from probe SP8-9 on December 11, 2011, and compared with the on-site instrument. The results were as follows ($\mu\text{g}/\text{m}^3$):

	On-site GC	H&P TO-15
CHCl ₃	118	100
PCE	140	160

Based on these results, no adjustments in the online GC data were made. In the setup for the second phase, eliminating the concentration trap and adding additional calibration points resulted in a better data match than in Phase 1. Given that the primary purpose of the online GC was to look for temporal variations, rather than making direct concentration comparisons to the other methods, the calibration results above were determined to be adequate for this research goal.

4.5.5 Agreement of Online GC Results with TO-17 Verification Samples

ATL prepared four 3-L Tedlar bags¹ each containing approximately 2 L of vapor labeled A, B, C, and D and sent them to the Indianapolis field site. Bags A and B were duplicate nitrogen blanks. Bags C and D were duplicate spikes with chloroform, TCE, and PCE drawn from a common Summa canister. Analyses were performed of these bags using the online GC and by ARCADIS staff collecting TO-17 samples directly from the bags and submitting them to the National Exposure Research Laboratory (NERL) for analysis. ATL also performed analyses before sending the bags to Indianapolis and after their return from the field. Results of these interlaboratory comparisons are provided in **Table 4-23** and statistical comparison in **Table 4-24**.

¹ Tedlar bags were used because of the need to pull samples with a syringe and the online GC at atmospheric pressure. Method 0040 and other studies have shown that standards are stable in Tedlar bags for up to 72 hours for a variety of chlorinated ethanes, ethenes (including TCE and PCE), and carbon tetrachloride.

Table 4-23. Interlaboratory Results: Spiked Verification Samples

Bag	Laboratory	Subsample Date	Analysis Date	PCE flag	PCE $\mu\text{g}/\text{m}^3$	PCE ppbv	TCE flag	TCE $\mu\text{g}/\text{m}^3$	TCE ppbv	Chloroform Flag	Chloroform $\mu\text{g}/\text{m}^3$	Chloroform ppbv
D	Air Toxics	8/9/2011	8/9/2011			21			34			42
A	Hartman	8/11/2011	8/11/2011	<		2	<		2	<		2
B	Hartman	8/11/2011	8/11/2011	<		2	<		2	<		2
C	Hartmann	8/11/2011	8/11/2011			20			28			40
D	Hartman	8/11/2011	8/11/2011			20			23			40
C	Air Toxics	8/12/2011	8/12/2011			13			16			20
D	Air Toxics	8/12/2011	8/12/2011			12			16			21
B	EPA NERL	8/10/2011	8/14/2011	U	8.5	1.2	U	6.7	1.2	B	12	2.4
A	EPA NERL	8/10/2011	8/14/2011	U	8.5	1.2	U	6.7	1.2	U	6.2	1.3
D	EPA NERL	8/10/2011	8/14/2011		85	12.3		110	20.1		140	28.2
B	EPA NERL	8/10/2011	8/14/2011	U	8.5	1.2	U	6.7	1.2	B	12	2.4
A	EPA NERL	8/10/2011	8/14/2011	U	8.5	1.2	U	6.7	1.2	B	11	2.2
D	EPA NERL	8/10/2011	8/14/2011		80	11.6		110	20.1		130	26.2
C	EPA NERL	8/10/2011	8/14/2011		89	12.9		110	20.1		140	28.2
C	EPA NERL	8/10/2011	8/14/2011		84	12.2		110	20.1		130	26.2

Data quality flags: “<” = less than, “U” = compound analyzed and reported as below the MDL; “B” = Compound concentration is flagged because the compound was detected in the associated method blank.

Table 4-24. Interlaboratory Statistics: Spiked Verification Samples

Data Summary for Interlab Data		Interlab comparison					
		Standard Samples after Pooling c and d: Interlab Comparison Using Standard Results					
		Mean (ppbv)			% Difference (% error)**		
Chemical	Actual (TO-15)	Air Toxics (N=3)	EPA NERL (N=4)	Hartman (N=2)	Air Toxics vs. EPA NERL	Air Toxics vs. Hartman	Air Toxics vs. Hartman
Chloroform	42	27.7	27.2	40.0	1.64	38.03	36.45
Tetrachloroethene	21	15.3	12.3	20.0	22.24	47.95	26.42
Trichloroethene	34	22.0	20.1	25.5	8.80	23.46	14.74

4.5.6 Agreement of Integrated Online GC Results with Passive Samplers

Table 4-25 compares the concentrations measured by the 1-week Radiello samples to the concentrations calculated by averaging the online GC results. For chloroform, agreement is generally remarkably good for the first 4 weeks of instrument operation. The results for this period are generally within 50 relative percent difference, which we considered good for this comparison between two different methods, given that variability in interlaboratory comparisons for split samples of VOCs using one method can be larger. Expressed as a ratio during this period, the online GC result is always between 0.6 and 1.9 times the Radiello result.

However, for chloroform, agreement is noticeably worse in succeeding weeks (after September 14, 2011). Generally, the chloroform values reported from the online GC are 1 to 3 times higher than the values from the corresponding Radiello sample, although higher ratios up to 6 times higher were occasionally observed, associated with the lowest concentration Radiello results. During the period when ambient samples were also collected with the online GC, those results tended to comprise a more significant fraction of the measured indoor air values than was seen in the Radiello samples. This result suggests the possible existence of an elevated baseline in the online GC data.

For PCE, the relationship between the online GC and the Radiello samples appears more stable with the vast majority of the results showing online GC results 1 to 3 times higher than the corresponding Radiello data.

Despite the substantial differences between the absolute values for either compound measured by the two methods, when the data are examined in terms of the *ratio* of concentrations on the first floor to concentrations measured in the basement, there is reasonably close agreement between the two instruments.

Table 4-25. Comparison of Online GC to Radiello Results

Radiello Location Code	Online GC Probe	Radiello Interval: Start	Radiello Interval: End	Number of Matched GC Runs	Online GC Statistics				Radiello Measurements		% Difference = (on line-Radiello)/average (Online, Radiellos)		Ratio (online Result/Radiello)		Ratio (First/Basement) From Online GC		Ratio (First/Avg Basement) from Radiello Data	
					Mean Chloroform	N Chloroform	Mean PCE	N PCE	Chloroform	PCE	Chloroform	PCE	Chloroform	Tetrachloroethene	Chloroform	Tetrachloroethene		
420BaseN - A	P4	8/10/11 15:51	8/17/11 18:11	63	0.179	57	0.572	51	0.23	0.34	-25%	51%	0.78	1.68				
420BaseS - A	P4	8/10/11 15:43	8/17/11 17:53	63	0.179	57	0.572	51	0.22	0.42	-21%	31%	0.81	1.36				
420First - A	P2	8/10/11 15:38	8/17/11 17:34	63	0.146	63	0.373	45	0.23	0.32	-45%	15%	0.63	1.17	0.82	0.65	1.02	0.84
422BaseN - A	P5	8/10/11 15:25	8/17/11 16:54	62	0.240	56	0.953	58	0.2	0.56	18%	52%	1.20	1.70				
422BaseS - A	P5	8/10/11 15:31	8/17/11 17:13	62	0.240	56	0.953	58	0.2	0.65	18%	38%	1.20	1.47				
422First - A	P3	8/10/11 15:19	8/17/11 16:31	62	0.120	62	0.415	46	0.18	0.23	-40%	57%	0.67	1.81	0.50	0.44	0.90	0.38
420BaseN - A	P4	8/17/11 18:13	8/24/11 16:17	70	0.201	70	0.700	69	0.12	0.31	50%	77%	1.67	2.26				
420BaseS - A	P4	8/17/11 17:55	8/24/11 16:21	70	0.201	70	0.700	69	0.13	0.38	43%	59%	1.54	1.84				
420First - A	P2	8/17/11 17:36	8/24/11 16:14	70	0.164	70	0.643	70	0.18	0.3	-9%	73%	0.91	2.14	0.82	0.92	1.44	0.87
422BaseN - A	P5	8/17/11 17:01	8/24/11 15:51	71	0.226	71	0.827	71	0.13	0.32	54%	88%	1.74	2.58				
422BaseS - A	P5	8/17/11 17:17	8/24/11 15:58	71	0.226	71	0.827	71	0.17	0.53	28%	44%	1.33	1.56				
422First - A	P3	8/17/11 16:34	8/24/11 15:44	71	0.130	71	0.504	70	0.15	0.21	-15%	82%	0.86	2.40	0.57	0.61	1.00	0.49
420BaseN - A	P4	8/24/11 16:20	8/31/11 15:58	65	0.249	65	0.625	65	0.24	0.33	4%	62%	1.04	1.89				
420BaseS - A	P4	8/24/11 16:22	8/31/11 15:51	65	0.249	65	0.625	65	0.19	0.4	27%	44%	1.31	1.56				
420First - A	P2	8/24/11 16:16	8/31/11 15:44	65	0.193	65	0.594	65	0.24	0.33	-22%	57%	0.80	1.80	0.77	0.95	1.12	0.90

Section 4—Results and Discussion: QA Checks of Individual Data Sets

Radiello Location Code	Online GC Probe	Radiello Interval: Start	Radiello Interval: End	Number of Matched GC Runs	Online GC Statistics				Radiello Measurements		% Difference = (on line-Radiello)/average (Online, Radiellos)		Ratio (online Result/Radiello)		Ratio (First/Basement) From Online GC		Ratio (First/Avg Basement) from Radiello Data	
					Mean Chloroform	N Chloroform	Mean PCE	N PCE	Chloroform	PCE	Chloroform	PCE	Chloroform	PCE	Chloroform	Tetrachloroethene	Chloroform	Tetrachloroethene
422BaseN - A	P5	8/24/11 15:53	8/31/11 3:17	60	0.165	60	0.564	60	0.088	0.16	61%	112%	1.88	3.52				
422BaseS - A	P5	8/24/11 16:00	8/31/11 15:24	64	0.164	64	0.557	64	0.099	0.2	50%	94%	1.66	2.78				
422First - A	P3	8/24/11 15:47	8/31/11 15:10	64	0.101	64	0.294	64	0.12	0.11	-17%	91%	0.84	2.67	0.62	0.53	1.28	0.61
420BaseN - A	P4	9/7/11 15:41	9/14/11 18:25	53	0.294	53	0.582	53	0.24	0.25	20%	80%	1.23	2.33				
420BaseS - A	P4	9/7/11 15:36	9/14/11 18:09	53	0.294	53	0.582	53	0.26	0.36	12%	47%	1.13	1.62				
420First - A	P2	9/7/11 15:29	9/14/11 17:48	52	0.282	52	0.768	52	0.21	0.22	29%	111%	1.34	3.49	0.96	1.32	0.84	0.72
422BaseN - A	P5	9/7/11 15:17	9/14/11 17:12	53	0.711	53	1.137	53	0.42	0.6	51%	62%	1.69	1.89				
422BaseS - A	P5	9/7/11 15:22	9/14/11 17:27	53	0.711	53	1.137	53	0.71	0.89	0%	24%	1.00	1.28				
422First - A	P3	9/7/11 15:12	9/14/11 16:57	53	0.439	53	0.761	52	0.59	0.77	-29%	-1%	0.74	0.99	0.62	0.67	1.04	1.03
420BaseN - A	P4	9/14/11 18:28	9/21/11 17:29	51	0.683	51	0.678	44	0.35	0.53	64%	25%	1.95	1.28				
420BaseS - A	P4	9/14/11 18:11	9/21/11 17:23	51	0.683	51	0.678	44	0.25	0.63	93%	7%	2.73	1.08				
420First - A	P2	9/14/11 17:49	9/21/11 17:18	51	0.698	51	0.948	43	0.26	0.35	91%	92%	2.68	2.71	1.02	1.40	0.87	0.60
422BaseN - A	P5	9/14/11 17:14	9/21/11 16:57	51	1.096	51	1.138	47	0.44	0.65	85%	55%	2.49	1.75				
422BaseS - A	P5	9/14/11 17:29	9/21/11 17:02	51	1.096	51	1.138	47	0.38	0.94	97%	19%	2.88	1.21				
422First - A	P3	9/14/11 16:59	9/21/11 16:50	51	0.506	51	0.544	43	0.23	0.33	75%	49%	2.20	1.65	0.46	0.48	0.56	0.42
420BaseN - A	P4	9/21/11 17:31	9/28/11 16:22	62	0.460	62	0.586	36	0.092	0.26	133%	77%	5.00	2.25				

Section 4—Results and Discussion: QA Checks of Individual Data Sets

Radiello Location Code	Online GC Probe	Radiello Interval: Start	Radiello Interval: End	Number of Matched GC Runs	Online GC Statistics				Radiello Measurements		% Difference = (on line-Radiello)/average (Online, Radiellos)		Ratio (online Result/Radiello)		Ratio (First/Basement) From Online GC		Ratio (First/Avg Basement) from Radiello Data	
					Mean Chloroform	N Chloroform	Mean PCE	N PCE	Chloroform	PCE	Chloroform	PCE	Chloroform	PCE	Chloroform	Tetrachloroethene	Chloroform	Tetrachloroethene
420BaseS - A	P4	9/21/11 17:25	9/28/11 16:09	62	0.460	62	0.586	36	0.089	0.27	135%	74%	5.17	2.17				
420First - A	P2	9/21/11 17:20	9/28/11 15:58	62	0.577	62	0.908	36	0.094	0.18	144%	134%	6.13	5.04	1.25	1.55	1.04	0.68
422BaseN - A	P5	9/21/11 16:59	9/28/11 15:26	62	0.783	62	1.158	39	0.17	0.54	129%	73%	4.61	2.14				
422BaseS - A	P5	9/21/11 17:05	9/28/11 15:39	62	0.783	62	1.158	39	0.22	0.6	112%	63%	3.56	1.93				
422First - A	P3	9/21/11 16:53	9/28/11 15:08	62	0.427	62	0.538	33	0.14	0.27	101%	66%	3.05	1.99	0.55	0.46	0.72	0.47
420BaseN - A	P4	10/6/11 16:53	10/12/11 16:51	53	0.667	53	0.845	47	0.32	0.6	70%	34%	2.08	1.41				
420BaseS - A	P4	10/6/11 16:43	10/12/11 16:34	53	0.667	53	0.845	47	0.26	0.58	88%	37%	2.56	1.46				
420First - A	P2	10/6/11 16:33	10/12/11 16:16	53	0.776	53	1.288	42	0.23	0.51	109%	87%	3.37	2.53	1.16	1.52	0.79	0.86
422BaseN - A	P5	10/6/11 16:09	10/12/11 15:39	54	0.981	54	1.282	45	0.31	1	104%	25%	3.16	1.28				
422BaseS - A	P5	10/6/11 16:20	10/12/11 15:53	53	0.984	53	1.283	44	0.52	1	62%	25%	1.89	1.28				
422First - A	P3	10/6/11 15:59	10/12/11 15:24	53	0.701	53	0.947	43	0.53	1.1	28%	-15%	1.32	0.86	0.71	0.74	1.28	1.10
420BaseN - A	P4	11/30/11 13:33	12/7/11 18:26	91	0.527	24	0.436	89	0.23	0.41	78%	6%	2.29	1.06				
420BaseS - A	P4	11/30/11 13:28	12/7/11 18:12	91	0.527	24	0.436	89	0.28	0.4	61%	9%	1.88	1.09				
420First - A	P2	11/30/11 13:21	12/7/11 17:49	91		0	0.220	89	0.23	0.32	NA	-37%	0.00	0.69	NA	0.51	0.90	0.79
422BaseN - A	P5	11/30/11 13:01	12/7/11 16:40	90	0.776	90	1.300	90	0.38	0.56	68%	80%	2.04	2.32				
422BaseS - A	P5	11/30/11 13:07	12/7/11 17:08	91	0.779	91	1.304	91	0.42	0.75	60%	54%	1.86	1.74				

Section 4—Results and Discussion: QA Checks of Individual Data Sets

Radiello Location Code	Online GC Probe	Radiello Interval: Start	Radiello Interval: End	Number of Matched GC Runs	Online GC Statistics				Radiello Measurements		% Difference = (on line-Radiello)/average (Online, Radiellos)		Ratio (online Result/Radiello)		Ratio (First/Basement) From Online GC GC		Ratio (First/Avg Basement) from Radiello Data Radiello	
					Mean Chloroform	N Chloroform	Mean PCE	N PCE	Chloroform	PCE	Chloroform	PCE	Chloroform	PCE	Chloroform	Tetrachloroethene	Chloroform	Tetrachloroethene
422First - A	P3	11/30/11 12:56	12/7/11 16:17	90	0.515	42	0.581	90	0.33	0.45	44%	25%	1.56	1.29	0.66	0.45	0.83	0.69
420BaseN - A	P4	12/7/11 18:27	12/14/11 16:44	100	0.581	55	0.765	100	0.37	0.39	44%	65%	1.57	1.96				
420BaseS - A	P4	12/7/11 18:13	12/14/11 16:20	101	0.581	55	0.761	101	0.3	0.41	64%	60%	1.94	1.86				
420First - A	P2	12/7/11 17:51	12/14/11 16:09	101		0	0.560	99	0.22	0.31	NA	57%	0.00	1.81	NA	0.74	0.66	0.78
422BaseN - A	P5	12/7/11 16:43	12/14/11 15:33	101	1.092	101	1.835	100	0.55	0.63	66%	98%	1.99	2.91				
422BaseS - A	P5	12/7/11 17:10	12/14/11 15:41	100	1.092	100	1.836	99	0.86	0.93	24%	66%	1.27	1.97				
422First - A	P3	12/7/11 16:19	12/14/11 15:27	101	0.640	98	0.995	101	0.39	0.48	49%	70%	1.64	2.07	0.59	0.54	0.55	0.62
Ambient - A	P1	12/7/11 17:33	12/14/11 17:00	101	0.512	6	0.420	101	0.13	0.23	119%	59%	3.94	1.83				
420bASEn - i	P4	12/9/11 13:02	12/15/11 15:49	82	0.600	45	0.851	82	0.27	0.4	76%	72%	2.22	2.13				
420bASEs - i	P4	12/9/11 12:57	12/15/11 15:46	82	0.600	45	0.851	82	0.26	0.34	79%	86%	2.31	2.50				
420fIRST - i	P2	12/9/11 12:41	12/15/11 15:43	82		0	0.800	80	0.18	0.25	NA	105%	0.00	3.20	NA	0.94	0.68	0.68
422bASEn - i	P5	12/9/11 12:25	12/15/11 15:29	82	1.094	82	1.872	81	0.57	0.57	63%	107%	1.92	3.28				
422bASEs - i	P5	12/9/11 12:33	12/15/11 15:35	82	1.094	82	1.872	81	0.8	0.9	31%	70%	1.37	2.08				
422fIRST - i	P3	12/9/11 12:12	12/15/11 15:08	82	0.653	76	1.049	82	0.36	0.47	58%	76%	1.81	2.23				
422fIRST - j	P3	12/9/11 12:16	12/15/11 15:10	82	0.653	76	1.049	82	0.36	0.47	58%	76%	1.81	2.23	0.60	0.56	0.53	0.64
AMBIENT - DOWN	P1	12/9/11 13:17	12/15/11 16:12	83	0.564	8	0.555	83	0.12	0.21	130%	90%	4.70	2.64				

Section 4—Results and Discussion: QA Checks of Individual Data Sets

Radiello Location Code	Online GC Probe	Radiello Interval: Start	Radiello Interval: End	Number of Matched GC Runs	Online GC Statistics				Radiello Measurements		% Difference = (on line-Radiello)/average (Online, Radiellos)		Ratio (online Result/Radiello)		Ratio (First/Basement) From Online GC		Ratio (First/Avg Basement) from Radiello Data	
					Mean Chloroform	N Chloroform	Mean PCE	N PCE	Chloroform	PCE	Chloroform	PCE	Chloroform	PCE	Chloroform	Tetrachloroethene	Chloroform	Tetrachloroethene
420BaseN - A	P4	12/14/11 16:47	12/22/11 17:38	104	0.696	12	0.271	98	0.12	0.15	141%	57%	5.80	1.80				
420BaseS - A	P4	12/14/11 16:21	12/22/11 17:26	104	0.696	12	0.271	98	0.12	0.16	141%	51%	5.80	1.69				
420First - A	P2	12/14/11 16:42	12/22/11 17:12	103		0	0.268	101	0.067	0.09	NA	99%	0.00	2.98	NA	0.99	0.56	0.58
422BaseN - A	P5	12/14/11 15:35	12/22/11 18:04	105	0.845	89	1.560	102	0.42	0.43	67%	114%	2.01	3.63				
422BaseS - A	P5	12/14/11 15:42	12/22/11 18:16	105	0.845	89	1.560	102	0.61	0.62	32%	86%	1.39	2.52				
422First - A	P3	12/14/11 15:28	12/22/11 17:52	104	0.540	55	0.644	99	0.26	0.32	70%	67%	2.08	2.01	0.64	0.41	0.50	0.61
Ambient - A	P1	12/14/11 17:01	12/22/11 16:49	105	0.612	5	0.482	94	0.051	0.094	169%	135%	12.00	5.13				
420BaseN - A	P4	1/4/12 17:04	1/11/12 17:35	98	0.342	45	0.302	98	0.14	0.2	84%	41%	2.44	1.51				
420BaseS - A	P4	1/4/12 17:19	1/11/12 17:19	98	0.342	45	0.302	98	0.14	0.2	84%	41%	2.44	1.51				
420First - A	P2	1/4/12 16:55	1/11/12 16:55	98	0.290	39	0.168	98	0.12	0.17	83%	-1%	2.42	0.99	0.85	0.56	0.86	0.85
422BaseN - A	P5	1/4/12 14:41	1/11/12 14:41	98	0.959	98	1.307	98	0.42	0.46	78%	96%	2.28	2.84				
422BaseS - A	P5	1/4/12 14:58	1/11/12 14:58	98	0.959	98	1.307	98	0.68	0.71	34%	59%	1.41	1.84				
422First - A	P3	1/4/12 14:24	1/11/12 14:24	98	0.527	94	0.569	98	0.22	0.35	82%	48%	2.40	1.63	0.55	0.44	0.40	0.60
Ambient - A	P1	1/4/12 16:39	1/11/12 16:39	98	0.284	36	0.279	94	0.1	0.18	96%	43%	2.84	1.55				
420BaseN - A	P4	1/11/12 15:07	1/18/12 15:07	102	0.295	92	0.297	102	0.16	0.3	59%	-1%	1.84	0.99				
420BaseS - A	P4	1/11/12 15:01	1/18/12 15:01	102	0.295	92	0.297	102	0.14	0.19	71%	44%	2.11	1.57				

Section 4—Results and Discussion: QA Checks of Individual Data Sets

Radiello Location Code	Online GC Probe	Radiello Interval: Start	Radiello Interval: End	Number of Matched GC Runs	Online GC Statistics				Radiello Measurements		% Difference = (on line-Radiello)/average (Online, Radiellos)		Ratio (online Result/Radiello)		Ratio (First/Basement) From Online GC		Ratio (First/Avg Basement) from Radiello Data	
					Mean Chloroform	N Chloroform	Mean PCE	N PCE	Chloroform	PCE	Chloroform	PCE	Chloroform	PCE	Chloroform	Tetrachloroethene	Chloroform	Tetrachloroethene
420First - A	P2	1/11/12 14:56	1/18/12 14:56	102	0.290	62	0.249	102	0.11	0.14	90%	56%	2.64	1.78	0.98	0.84	0.73	0.57
422BaseN - A	P5	1/11/12 14:44	1/18/12 14:44	101	1.070	100	2.159	100	0.44	0.75	83%	97%	2.43	2.88				
422BaseS - A	P5	1/11/12 14:50	1/18/12 14:50	101	1.070	100	2.159	100	0.73	1.1	38%	65%	1.47	1.96				
422First - A	P3	1/11/12 14:38	1/18/12 14:38	101	0.553	100	0.924	100	0.36	0.54	42%	52%	1.54	1.71	0.52	0.43	0.62	0.58
Ambient - A	P1	1/11/12 15:13	1/18/12 15:13	101	0.274	45	0.079	95	0.09	0.067	101%	16%	3.05	1.18				

4.6 Radon

4.6.1 Indoor Air: Comparison of Electrets Field, ARCADIS to Charcoal Analyzed by U.S. EPA Radiation and Indoor Environment (R&IE) National Laboratory

Three comparisons were made between electrets and charcoal canisters. Charcoal canisters were provided by and analyzed by the U.S. EPA R&IE National Laboratory Center for Indoor Environments in Las Vegas, Nevada. ARCADIS collected charcoal canister samples and electret samples. Electrets were obtained from Rad Elec (Frederick, Maryland) and read by ARCADIS on site before and after deployment. The charcoal canisters were used as a QC check on three separate occasions: January 19, 2011 to January 26, 2011; April 27, 2011 to May 4, 2011; and December 28, 2011 to January 4, 2012. Charcoal canisters (plus duplicates) were placed at indoor locations and the ambient locations that were routinely being used for electret monitoring. When the results were received, the sample plus its duplicate were averaged together to obtain a result for the location. This result was then compared with the electret result for that location and time period.

For the first occasion, the relative percent difference between the two methods was 20% or less (**Table 4-26**). The maximum absolute difference was 0.63 pCi. A relative percent difference could not be calculated for the ambient, which was below the detection limit with the charcoal method (below detection limits; BDL).

On the second occasion, five of six comparisons showed a relative percent difference of 20% or less and four of the six comparisons were within 0.5 pCi/L of each other (**Table 4-27**).

The exceptions were 422 basement north and 420 basement south, which were within 0.9 pCi/L of each other. The ambient was again BDL by the charcoal method, as would have been predicted from the electret data.

For the third occasion, December 28, 2011 to January 4, 2012, the absolute difference between the methods is at or below 0.3 pCi/L and RPD is <6% for all samples (**Table 4-28**). The ambient charcoal sample was below the detection limit and that detection limit was equal to the ambient value reported by the electret method.

Table 4-26. Comparison between Electrets and Charcoal Canisters at the 422/420 EPA House from January 19–26, 2011

Sample Location	Electret Rn (pCi/L)	Charcoal Rn (pCi/L)	Charcoal Average	Absolute Difference (pCi/L)	RPD (%)
422 First floor	5.14	4.8	4.7	0.44	6.84%
422 First floor		4.6			
422 Basement N	8.44	8	8.4	0.04	5.35%
422 Basement N		8.8			
420 First floor	1.68	1.7	1.65	0.03	-1.18%
420 First floor		1.6			
420 Basement N	3.98	3.3	3.35	0.63	18.68%
420 Basement N		3.4			
Ambient	0.03	<0.5	<0.5		
Ambient		<0.5			

Table 4-27. Comparison of Electret and Charcoal Canister Data from April 27, 2011, to May 4, 2011

Location	Electret Data (pCi/L)	Charcoal Canister Radon Activity (pCi/L)	Charcoal Canister Average Radon Activity (pCi/L)	Absolute Difference (pCi/L)	RPD (%)
Ambient	0.47	<0.5			
Ambient duplicate		<0.5			
422 First floor	2.72	2.8	2.6	0.12	4.51%
422 First floor duplicate		2.4			
422 Basement S	7.39	7.3	7	0.39	5.42%
422 Basement S duplicate		6.7			
422 Basement N	7.14	6.3	6.05	0.905	13.92%
422 Basement N duplicate	6.77	5.8			
420 First floor	0.98	1.3	1.4	-0.42	-35.29%
420 First floor duplicate		1.5			
420 Basement S	4.58	3.8	3.75	0.83	19.93%
420 Basement S duplicate		3.7			
420 Basement N	4.48	4.2	3.95	0.53	12.57%
420 Basement N duplicate		3.7			
Field blank	NA	<0.5			
Field blank	NA	<0.5			

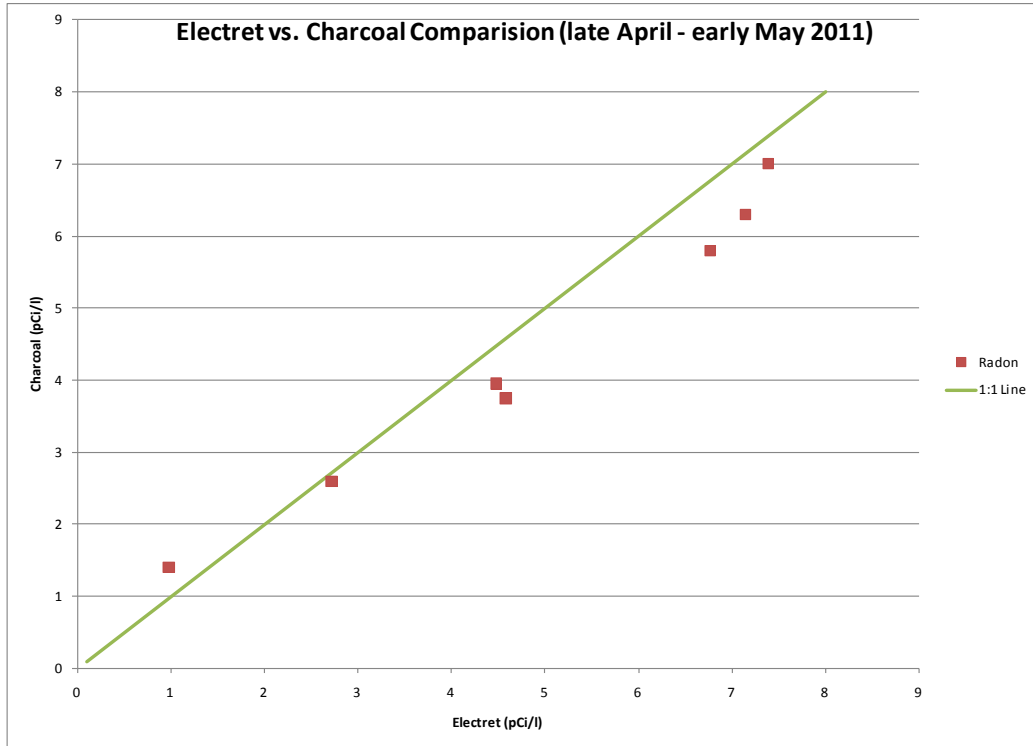

Figure 4-1. Correlation between radon measured using the electret and charcoal methods.

Table 4-28. Comparison of Charcoal and Electret Radon December 28, 2011, to January 4, 2012

Canister ID	Radon Activity (pCi/l)	Charcoal Average (pCi/l)	Location	Electrets (pCi/L)	Absolute Difference (pCi/L)	RPD (%)
877138	3.1	3.2	420 Basement N	3.34	-0.2	-5.86%
877113	3.2		420 Basement N Dup			
877137	2.8	2.8	420 Basement S	2.72	0.0	1.10%
877115	2.7		420 Basement S Dup			
877133	1.1	1.1	420 First floor	1.09	0.0	-3.74%
877107	1.0		420 First floor Dup			
877139	10.0	10.0	422 Basement N	10.22	-0.3	-2.67%
877136	9.9		422 Basement N Dup	10.35		
877128	9.6	9.5	422 Basement S	9.57	-0.1	-0.73%
877111	9.4		422 Basement S Dup			
877108	4.8	4.8	422 First floor	4.86	-0.1	-2.29%
877140	4.7		422 First floor Dup			
877110	5.0	5.2	422 Office	4.92	0.2	4.57%
877131	5.3		422 Office Dup			
877130	<0.5		Ambient	0.5	NA	NA

4.6.2 Comparison of Average of Real Time Alphaguard to Electrets and Charcoal Canisters

Stationary Alphaguard units provided by the U.S. EPA were used for real-time monitoring of indoor air radon at two locations (422 Basement North and 422 Office (2nd floor)). Several comparisons were made between the stationary Alphaguard data and electrets located nearby (initially at 422 basement north and later at both 422 basement north and 422 office).

The first comparison took place over several weeks between March 30, 2011 and May 18, 2011 (Table 4-29). The absolute difference ranged from -0.04 pCi/L to 1.44 pCi/L. The relative percent difference ranged from -0.50% to 26.04%.

Table 4-29. Comparison between 422 Base N Alphaguards and Electrets from March 30, 2011, and May 18, 2011

Date Range	Alphaguard Reading (pCi/L)	Electret (pCi/L)	Electret Dup(pCi/L)	Electret Ave (pCi/L)	Absolute Difference (pCi/L)	Relative Percent Difference
03/30–04/07	6.18	6.30	4.98	5.64	0.54	9.14%
04/07–04/13	5.90	4.94	5.87	5.41	0.50	8.76%
04/13–04/20	8.41	6.97	7.83	7.40	1.01	12.78%
04/20–04/27	6.25	4.04	5.58	4.81	1.44	26.04%
04/27–05/04	6.92	7.14	6.77	6.96	-0.04	-0.50%
05/04–05/11	4.66	2.93	4.50	3.72	0.95	22.57%
05/11–05/18	6.15	5.81	6.01	5.91	0.24	3.98%

For the second comparison, which occurred from August 3, 2011 to October 6, 2011, in the 422BaseN location, the absolute difference ranged from -1.11 pCi/L to 2.42 pCi/L. The relative percent difference ranged from -40.18% to 30.76% (Table 4-30).

Table 4-30. Comparison of Real-Time Alphaguard to Integrated Electret August through October

End Date/ Time	Rn (pCi/L) A Guard (averaged over a week)	Rn (pCi/L) Electrets 422 Base N	Rn (pCi/L) Electrets 422 Base N Dup	Average of Duplicate Electrets (pCi/L)	Absolute Difference (pCi/L)	Relative Percent Difference
8/3/2011	6.85	6.85	5.14	6.00	0.85	13.26%
8/10/2011	7.24	7.25	6.79	7.02	0.22	3.09%
8/17/2011	8.38	7.53	7.20	7.37	1.02	12.91%
8/24/2011	3.84	3.48	3.00	3.24	0.60	16.93%
8/31/2011	2.21	2.17	4.46	3.32	-1.11	-40.18%
9/7/2011	4.34	4.52	1.84	3.18	1.16	30.76%
9/14/2011	6.09	5.68	5.44	5.56	0.53	9.16%
9/21/2011	8.69	8.03	7.84	7.94	0.75	9.05%
9/28/2011	12.51	11.67	11.44	11.56	0.96	7.97%
10/6/2011	10.33	7.83	7.99	7.91	2.42	26.53%

During the third comparison, electrets, the Alphaguard, and the charcoal canisters were compared from December 28, 2011 to January 4, 2012. Only the 422 office and 422 basement north were compared by all three methods during this time. The absolute difference between the canisters and Alphaguard ranged from -0.05 pCi/L to 0.15 pCi/L, and the absolute difference between the electrets and Alphaguard ranged from -0.08 pCi/L to 0.29 pCi/L. The relative percent difference between canisters and Alphaguard ranged from -0.50% to 2.96% , and the relative percent difference between electrets and Alphaguard ranged from -1.61% to 2.81% (**Table 4-31**).

Table 4-31. Comparison of Real-time Alphaguards to Integrated Electret Measurements December 28, 2011 to January 4, 2012

Location	Canister Radon Activity (pCi/L)	Dup Canister Radon Activity (pCi/L)	Canister Average (pCi/L)	Electret (pCi/L)	Electret Dup (pCi/L)	Electret Average (pCi/L)	422 Base N Alphaguard Approximation (pCi/L)	Absolute Difference between Canisters and Alphaguards (pCi/L)	Absolute Difference between Electrets and Alphaguards (pCi/L)	Relative Percent Difference between Canisters and Alphaguard	Relative Percent Difference between Electrets and Alphaguard
422BaseN	10.00	9.90	9.95	10.22	10.35	10.29	10.00	-0.05	0.29	-0.50%	2.81%
422 Office	5.00	5.30	5.15	4.92			5.00	0.15	-0.08	2.96%	-1.61%

The fourth comparison occurred between January 4, 2012 and March 1, 2012 for both the 422 office and 422 basement north locations (**Table 4-32**). The absolute difference between 422 basement north Alphaguards and electrets ranged from -0.52 pCi/L to 1.79 pCi/L, and the absolute difference between 422 office Alphaguards and electrets ranged from 0.05 pCi/L to 0.77 pCi/L. The relative percent difference for 422 basement north ranged from -5.95% to 26.15% , and the relative percent difference for the 422 office ranged from 1.05% to 17.68% .

Table 4-32. Comparison of Real-Time Alphaguard to Integrated Electret Measurements January through March

Date Range	422 Base N Alphaguard Reading (pCi/L)	Office Alphaguard Reading (pCi/L)	422 Base N Electret (pCi/L)	422 Base N Dup Electret (pCi/L)	422 Base N Electret Average (pCi/L)	Office Electret (pCi/L)	Absolute Difference between 422 Base N Alphaguards and Electrets (pCi/L)	Absolute Difference between Office Alphaguards and Electrets (pCi/L)	422 Base N Relative Percent Difference	Office Relative Percent Difference
? - 01/04/12	10	5	10.22	10.35	10.29	4.92	-0.29	0.08	-2.81%	1.61%
01/04/12–01/11/12	8.78	4.69	9.05	9.11	9.08	4.56	0.30	0.13	-3.36%	2.81%
01/11/12–01/18/12	9.73	5.09	9.34	9.73	9.54	4.88	0.19	0.21	2.02%	4.21%
01/18/12–01/25/12	8.52	4.79	7.83	7.98	7.91	4.74	0.61	0.05	7.49%	1.05%
01/25/12–02/01/12	7.71	4.46	8.24	8.03	8.14	4.15	-0.43	0.31	-5.36%	7.20%
02/01/12–02/08/12	8.68	4.78	8.60	8.62	8.61	4.58	0.06	0.20	0.81%	4.27%
02/08/12–02/15/12	8.44	4.80	8.28	7.47	7.88	4.41	0.56	0.39	6.93%	8.47%
02/15/12–02/22/12	7.74	4.3	6.08	5.82	5.95	3.68	1.79	0.62	26.15%	15.54%
02/22/12–03/01/12	8.48	4.74	9.00	9.00	9.00	3.97	-0.52	0.77	-5.95%	17.68%

4.6.3 Quality Assurance Checks of Electrets

QC was performed on the electret reader and on the chambers holding the electrets. The QC check on the reader was performed by placing reference electrets within the reader each week to measure any deviation from the standard. The standard reference electrets were of 0 V, 245 V, and 250 V. Over the duration of the project, the readings on the 0 V electret fluctuated but stayed within 4 V of its nominal value. The 245 V electret, with only two exceptions, stayed within 20 V of its stated value. It steadily declined over the duration of the project, hitting a low before slowly rising toward the end of the project. The 250 V electret stayed within 6 V of its nominal value, showing a slight decline toward the end of the project.

To check for drift within the electret chambers, a normal electret was placed in a closed electret chamber each week and then read on the voltage meter to measure any change in the voltage from the previous week’s readings. This method would indicate any deviation caused by the chambers. Near the beginning of the project, this electret dropped an average of 5 V/4 weeks or 1.25 V per week. The rate was even lower in the second half of the project to a drop of 5 V/30 weeks or 0.16 V per week. These rates of drift are insignificant because the actual observed voltage change at the indoor sampling locations was typically 25V per week or more.

4.7 On-Site Weather Station vs. National Weather Service (NWS)

A VantageVue weather station from Davis Instruments was installed at the 422/420 house. Because it was not safe to mount the station directly on the peak of the roof, it was mounted on vertical rods raised to the approximate peak elevation from the edge of the second story roof. The trees near the house, especially to the north, are quite tall, equal to or higher than the weather station. Branches extend close to the house on the northwest corner. The house is much taller than the neighboring building to the east. There is also a neighboring two-story residential structure to the northeast, approximately 30 to 40 ft away. A seven-story commercial structure is approximately 150 ft southwest of the studied duplex. Essentially, the only side completely free from all air current obstructions is the southern side, which borders 28th Street (**Figure 4-2**).

A 2-month comparison between the house weather station data and NWS data was made from September 17, 2011 to November 17, 2011, as a QC check. Three parameters were compared: temperature, relative humidity, and wind speed. For temperature, the data from the two weather stations match very well, only differing by an average of 0.5 ° F (**Figure 4-3**). Relative humidity at both weather stations differed by an average of approximately 4% (**Figure 4-4**). House wind speed and that of the NWS differed by an average of approximately 6 mph; the airport weather station was generally higher. This difference is likely due to the local NWS station being at the Indianapolis International Airport. The Indianapolis International Airport (KIND) weather station is located in the middle of the runways at the Indianapolis Airport approximately 500 meters from the nearest building. Thus, the readings obtained at the house are probably a better representation of the wind speeds that directly impinge on the house (**Figure 4-5**).



Figure 4-2. Aerial view of study house, showing potential influences on wind velocity; red arrow indicates study house.

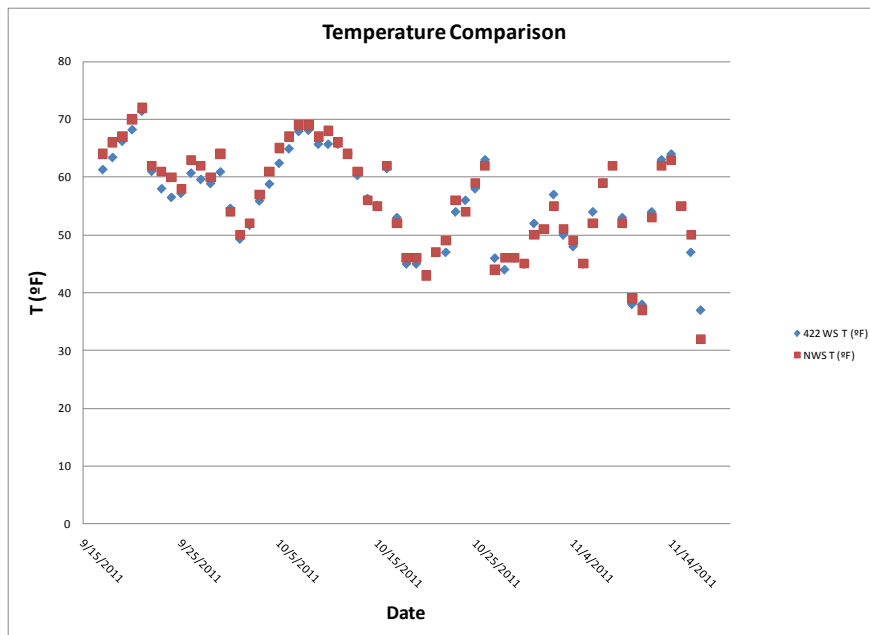

Figure 4-3. Comparison of National Weather Service Indianapolis temperature data to weather station at 422 East 28th Street.

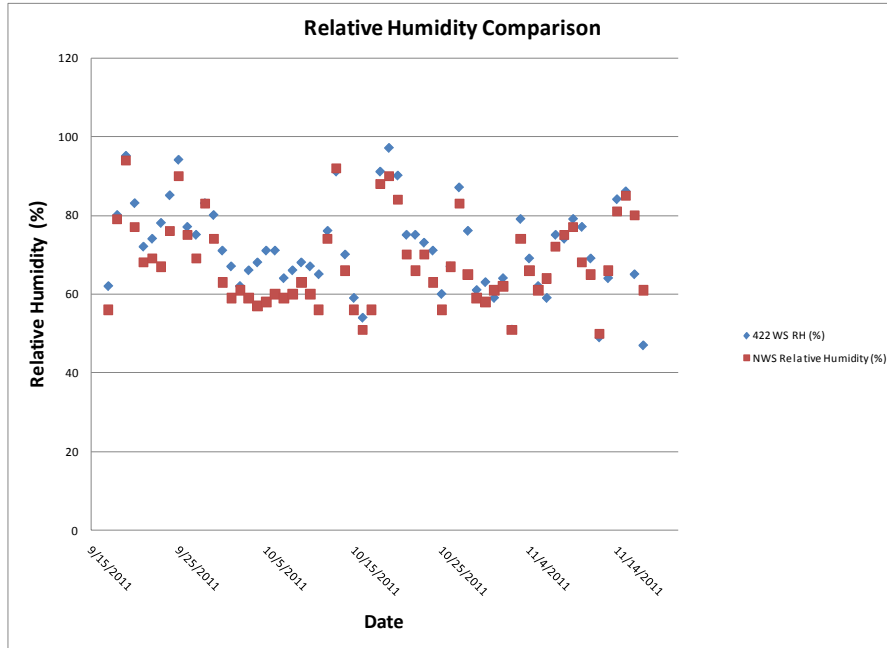

Figure 4-4. Comparison of National Weather Service Indianapolis relative humidity to weather station at 422 East 28th Street.

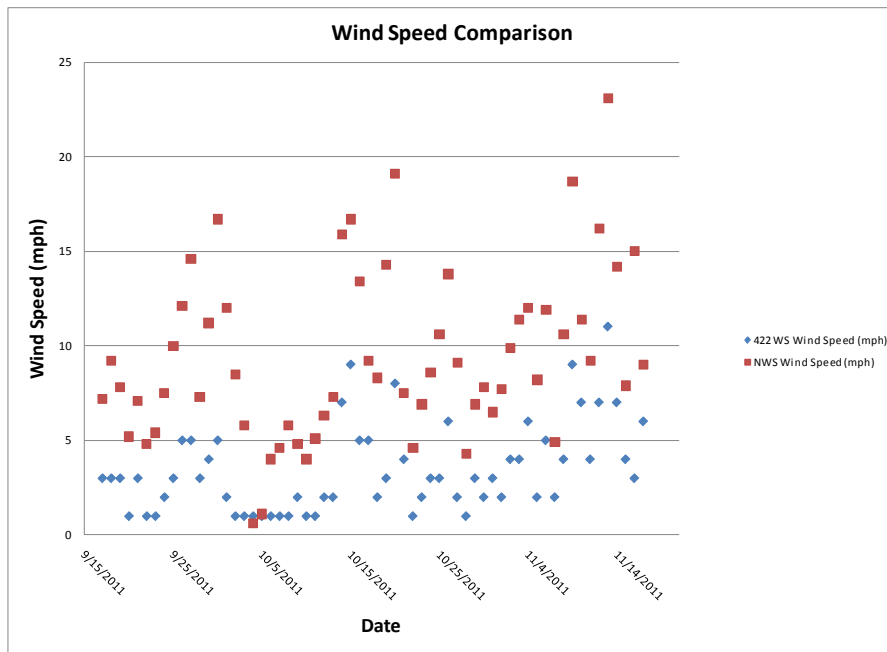

Figure 4-5. Comparison of National Weather Service wind speed data to weather station at 422 East 28th Street.

4.8 Database

4.8.1 Checks on Laboratory Reports

Throughout the project, the ARCADIS project manager briefly reviewed laboratory reports as they were received from the VOC analytical laboratories. The primary focus of these checks was on blanks and

ambient samples as a sampling performance indicator as well as the general consistency and reasonableness of the trends in reported concentrations for key analytes: PCE and chloroform.

The ARCADIS project manager also performed a manual review of the electrets radon computations in the spreadsheet used for those calculations. He also reviewed that data set regularly and interacted with the field scientist collecting these data when any anomalous results were observed.

The lead analyst (from Hartman-Environmental Geosciences), an ARCADIS principal scientist, and an RTI scientist were all involved in reviewing the online GC calculations. For suspect values, QC checks performed included calibration checks and chromatogram reviews.

4.8.2 Database Checks

A Microsoft Access database was developed and used to compile results for volatile organic compounds (VOCs) (TO-17, TO-15, and passive indoor air) and radon in indoor air and soil gas (electret and portable Alphaguard).

The following QC checks were performed on this database:

- The ARCADIS field scientist responsible for the majority of the field sampling performed a fairly intense check of the reports received from laboratories against his own records. He checked for the following: approximate number of each sample type (to determine what reports were still pending) and a line-by-line check of the sample times, dates, and sample numbers of each sample type. The assignment of sample locations was also reviewed. Notes of any discrepancies and corrections were sent to the ARCADIS database manager.
- During the initial portions of the project, the ATL technical director manually prepared an Excel spreadsheet from laboratory reports comparing the results of passive samplers exposed at the same location for multiple durations and calculating percentage bias. The ARCADIS project manager then used that spreadsheet to spot check the calculations of percentage bias performed in the database. After correcting for slight differences in the percentage bias formula used, excellent agreement was found. This agreement indicates that, at least for the calculations spot checked, both the calculation and the importation of the underlying concentration data from electronic deliverable files into the database are being performed correctly.
- During the initial portions of the project, the ATL technical director manually prepared an Excel spreadsheet of indoor air VOC results from laboratory reports. That Excel spreadsheet was used to prepare temporal trend plots of indoor concentrations for key analytes for the first 18 weeks of the project before the Access database was fully implemented. The ARCADIS project manager then confirmed that the essential features of these temporal trend plots (such as range of concentrations and overall temporal trends) were consistent between these plots and similar plots generated from the Access database. This result indicates for this period that the importation of the underlying concentration data from electronic deliverable files into the database is being performed correctly.
- The ARCADIS project manager provided to the database manager a design document for the reports to be generated, including definitions of key formulas and variables. The design document was prepared based on the project objectives in the Quality Assurance Project Plan (QAPP). As database reports were prepared, the ARCADIS project manager reviewed their format and content and requested changes as necessary.
- The ARCADIS project manager and database manager both spot checked the transfer of the NERL results for groundwater into the database.

Table of Contents

5.	Results and Discussion: VOC Concentration Temporal Trends and Relationship to HVAC	5-1
5.1	VOC Seasonal Trends Based on Weekly, Biweekly, and Monthly Measurements for 52+ Weeks	5-1
5.1.1	Indoor Air	5-1
5.1.2	Subslab Soil Gas.....	5-4
5.1.3	Shallow and Deep Soil Gas	5-8
5.2	Radon Seasonal Trends (based on Weekly Measurements).....	5-23
5.2.1	Indoor Air	5-23
5.2.2	Subslab and Wall Port Soil Gas	5-26
5.2.3	Deep Soil Gas.....	5-29
5.3	VOC Short-Term Variability (Based on Daily and Hourly VOC Sampling).....	5-35
5.3.1	Indoor air	5-35
5.3.2	Subsurface Soil Gas Data	5-41
5.4	Radon Short Term Variability (Based on Daily and More Frequent Measurements).....	5-48
5.4.1	Indoor Air	5-48
5.4.2	Subslab, Wall Port, and Deeper Soil Gas Radon Data	5-52
5.5	Outdoor Climate/Weather Data	5-52

List of Figures

5-1.	PCE in indoor and ambient air vs. time (7-day Radiello samples).....	5-2
5-2.	Chloroform in indoor and ambient air vs. time (7-day Radiello samples).....	5-2
5-3.	PCE, benzene, and toluene in indoor and ambient air.	5-3
5-4.	PCE and chloroform in 422 first-floor indoor air; weekly, biweekly, and monthly duration Radiello samples.....	5-3
5-5.	Plot of subslab chloroform concentrations vs. time.	5-4
5-6.	Plot of subslab chloroform concentrations vs. time, first intensive sampling period.	5-5
5-7.	Plot of subslab PCE concentrations vs. time.....	5-6
5-8.	Plot of subslab PCE concentrations vs. time, first intensive sampling period.....	5-6
5-9.	Plot of wall port chloroform concentrations vs. time.....	5-7
5-10.	Plot of wall port PCE concentrations vs. time.	5-8
5-11.	Chloroform concentrations at each of the SGP1 ports vs. time.	5-11
5-12.	PCE concentrations at each of the SGP1 ports vs. time.....	5-11
5-13.	Chloroform concentrations at each of the SGP2 ports vs. time.	5-12
5-14.	PCE concentrations at each of the SGP2 ports vs. time.....	5-12
5-15.	Chloroform concentrations at each of the SGP3 ports vs. time.	5-13
5-16.	PCE concentrations at each of the SGP3 ports vs. time.....	5-13
5-17.	Chloroform concentrations at each of the SGP4 ports vs. time.	5-14
5-18.	PCE concentrations at each of the SGP4 ports vs. time.....	5-14
5-19.	Chloroform concentrations at each of the SGP5 ports vs. time.	5-15
5-20.	PCE concentrations at each of the SGP5 ports vs. time.....	5-15
5-21.	Chloroform concentrations at each of the SGP6 ports vs. time.	5-16
5-22.	PCE concentrations at each of the SGP6 ports vs. time.....	5-16
5-23.	Chloroform concentrations at each of the SGP7 ports vs. time.	5-17
5-24.	PCE concentrations at each of the SGP7 ports vs. time.....	5-17
5-25.	Chloroform concentrations at SGP8 and 9 ports vs. time.....	5-18
5-26.	PCE concentrations at SGP8 and 9 ports vs. time.	5-18
5-27.	Chloroform concentrations at each of the SGP10 ports vs. time.	5-19

5-28.	PCE concentrations at each of the SGP10 ports vs. time.....	5-19
5-29.	Chloroform concentrations at each of the SGP11 ports vs. time.	5-20
5-30.	PCE concentrations at each of the SGP11 ports vs. time.....	5-20
5-31.	Chloroform concentrations at each of the SGP12 ports vs. time.	5-21
5-32.	PCE concentrations at each of the SGP12 ports vs. time.....	5-21
5-33.	Subslab PCE concentrations over a 1-week period during the first intensive round.	5-22
5-34.	Subslab PCE concentrations over a 1-week period during the second intensive round.	5-22
5-35.	Weekly electret readings for all locations.....	5-24
5-36.	Data for the downstairs continuously recording Alphaguard versus time.	5-25
5-37.	Data for the upstairs continuously recording Alphaguard versus time.	5-26
5-38.	This is a kriged radon image taken from subslab, wall, and multidepth soil gas data.	5-27
5-39.	Subslab Alphaguard data versus time.	5-28
5-40.	Wall port Alphaguard data versus time.....	5-28
5-41.	Kriged radon image taken from subslab, wall, and multidepth soil gas data.....	5-30
5-42.	Handheld Alphaguard data taken from soil gas ports at location 1 versus time.	5-31
5-43.	Handheld Alphaguard data taken from soil gas ports at location 4 versus time.	5-31
5-44.	Handheld Alphaguard data taken from soil gas ports at location 5 versus time.	5-32
5-45.	Handheld Alphaguard data taken from soil gas ports at location 7 versus time.	5-32
5-46.	Handheld Alphaguard data taken from soil gas ports at location 8 versus time.	5-33
5-47.	Handheld Alphaguard data taken from soil gas ports at location 9 versus time.	5-33
5-48.	Handheld Alphaguard data taken from soil gas ports at location 10 versus time.	5-34
5-49.	Handheld Alphaguard data taken from soil gas ports at location 11 versus time.	5-34
5-50.	Handheld Alphaguard data taken from soil gas ports at location 12 versus time.	5-35
5-51.	Online GC chloroform indoor air data for 422 first floor.	5-36
5-52.	Online GC chloroform indoor air data for 422 basement.	5-36
5-53.	Online GC chloroform indoor air data for 420 first floor.	5-38
5-54.	Online GC chloroform indoor air data for 420 basement.	5-38
5-55.	Online GC PCE indoor air data for 422 first floor.....	5-39
5-56.	Online GC PCE indoor air data for 422 basement.....	5-39
5-57.	Online GC PCE indoor air data for 420 first floor.....	5-40
5-58.	Online GC PCE indoor air data for 420 basement.....	5-40
5-59.	Online GC subsurface chloroform soil gas data—Phase 1 and Phase 2.	5-42
5-60.	Online GC subsurface chloroform soil gas data—Phase 1.	5-42
5-61.	Online GC subsurface chloroform soil gas data—Phase 2.	5-43
5-62.	Online GC subsurface PCE soil gas data—Phase 1 and Phase 2.....	5-44
5-63.	Online GC subsurface PCE soil gas data—Phase 1.....	5-44
5-64.	Online GC subsurface PCE soil gas data—Phase 2.....	5-45
5-65.	Method TO-17 data for SSP-4.	5-46
5-66.	Online GC PCE measurements in SSP-4.....	5-46
5-67.	Comparison of online GC measurements of PCE and chloroform in SGP9 at 6 ft.	5-47
5-68.	Electret indoor air radon concentrations for the first intensive round.	5-49
5-69.	Electret indoor air radon concentrations for the second intensive round.....	5-49
5-70.	Radon concentrations from the downstairs stationary Alphaguard during the second intensive round.....	5-50
5-71.	Radon concentrations from the upstairs stationary Alphaguard during the second intensive round.....	5-50
5-72.	Electret indoor air radon concentrations for the third intensive round.	5-51
5-73.	Radon concentrations from the downstairs stationary Alphaguard during the third intensive round.....	5-51
5-74.	Radon concentrations from the upstairs stationary Alphaguard during the third intensive round.....	5-52

5-75.	Temperature records from the external temperature monitor and the HOBO devices at seven indoor locations on the 422 and 420 sides of the house.....	5-54
5-76.	Indoor temperature as recorded inside the 422 second floor office.	5-55
5-77.	Stacked hydrological graph with depth to water in feet (top—red circles), discharge at Fall Creek in ft ³ /s (middle—blue line), and rainfall in inches (bottom—green line).	5-56
5-78.	Plot of barometric pressure (inches of Hg) external to the 422/420 house over time.....	5-57
5-79.	Barometric pressure (Pa) on the 422 side of the house over time.....	5-58

List of Tables

5-1.	Frequency of Nondetects (%) by Soil Gas Point or Cluster.....	5-9
5-2.	Frequency of Nondetects by Depth and Compound	5-9
5-3.	Summary Meteorological Data for Central Indiana.....	5-53

5. Results and Discussion: VOC Concentration Temporal Trends and Relationship to HVAC

5.1 VOC Seasonal Trends Based on Weekly, Biweekly, and Monthly Measurements for 52+ Weeks

5.1.1 Indoor Air

Figures 5-1 and **5-2** show PCE and chloroform versus time, respectively, at all seven air monitoring locations (including ambient). PCE levels at all six locations follow the same general trend of starting higher at the beginning of the project, dropping to a low in spring, and rising slightly and leveling out through the end of the project (see **Figure 5-1**). However, the timing of the spring minimum differed substantially for the unheated side of the duplex (when it occurred in late March) from the heated side of the duplex (where the minimum was reached in July). The highest readings were generally found at 422 basement south except during brief periods when first floor concentrations were higher (mostly periods of fan operations, see section 12.2).

Chloroform's behavior can be summarized in four main trends (see **Figure 5-2**):

1. Broadly, the six indoor locations show a general concentration decline from a localized maximum at the beginning of the sampling interval in January 2011. The minimum is reached at the end of spring on the 422 side of the house (early July), as with PCE. Also similar to PCE's behavior, the chloroform minimum on the 420 side of the house occurs much earlier in the year (March).
2. However, the levels at the 422 first floor sampling location rise abruptly to a maximum in March 2011 immediately after the first brief drop in January (see **Figure 5-2**). During this maximum, the first floor concentrations exceed those of even the basement stations. The 422 basement sampling stations show a less dramatic rise in this period.
3. Chloroform concentrations reached a minimum in July 2011 and began steadily increasing thereafter, forming a generally U-shaped curve. The winter 2012 levels more closely approach their original highs than do the corresponding PCE results.
4. The second maximum for chloroform occurs in October 2011 for the 420 (unheated) locations and is followed by a considerable decline through the winter months. The second peak occurs later (December 2012) on the 422 (heated) side of the duplex and concentrations stay near that maximum until February 2012.

With the exception of the elevated chloroform from late February to late March 2011, the highest chloroform levels were found at 422 basement south, the same station that was generally highest for PCE (**Figures 5-1** and **5-2**).

Figure 5-3 shows PCE, benzene, and toluene at 422 basement south versus time, along with ambient levels of benzene and toluene. Although both benzene and toluene are above their action levels (benzene = $0.31\mu\text{g}/\text{m}^3$; toluene = $0.0052\mu\text{g}/\text{m}^3$; EPA Regional Screening Level (RSL) Summary Table, Nov., 2011), each tends to trend similarly to its respective ambient; this is not the case with PCE, which is almost always considerable higher than its ambient. This suggests that benzene and toluene at this location are likely dominated by regional ambient sources, not soil gas vapor intrusion.

Figure 5-4 shows concentrations for 7-, 14-, and 28-day durations over the extent of the project at the 422 first floor sampling station versus time for both PCE and chloroform. Generally, sampling at all three durations shows the same trends, the only exception being the brief fan tests that influence the weekly

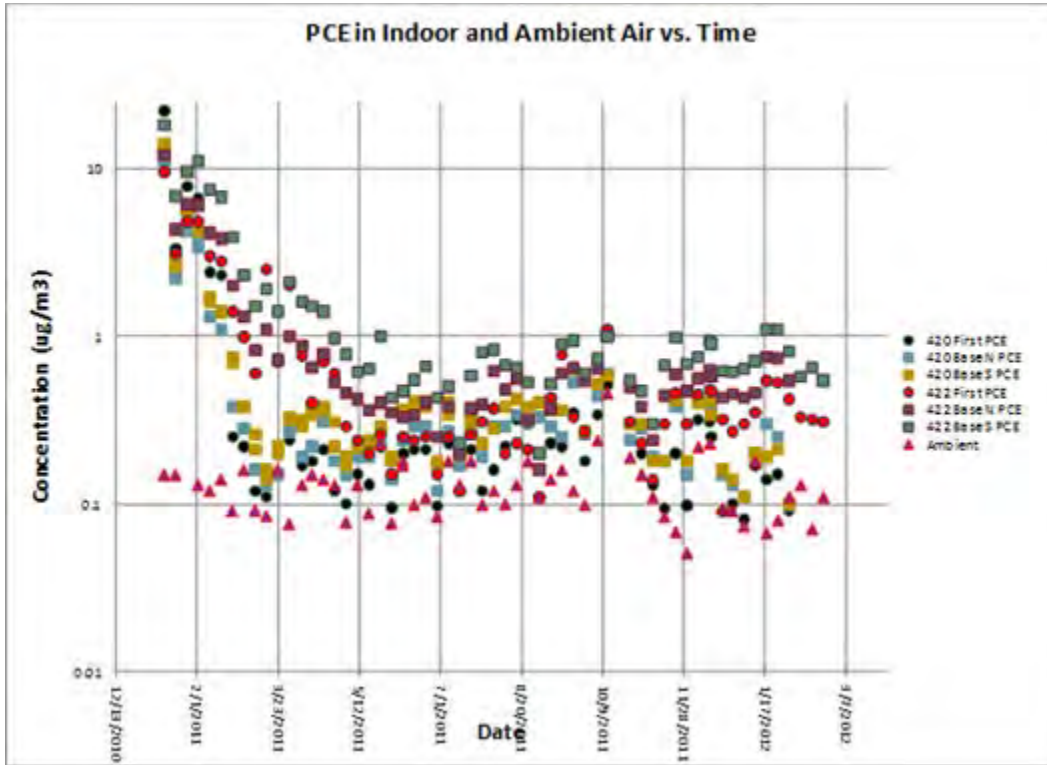

Figure 5-1. PCE in indoor and ambient air vs. time (7-day Radiello samples).

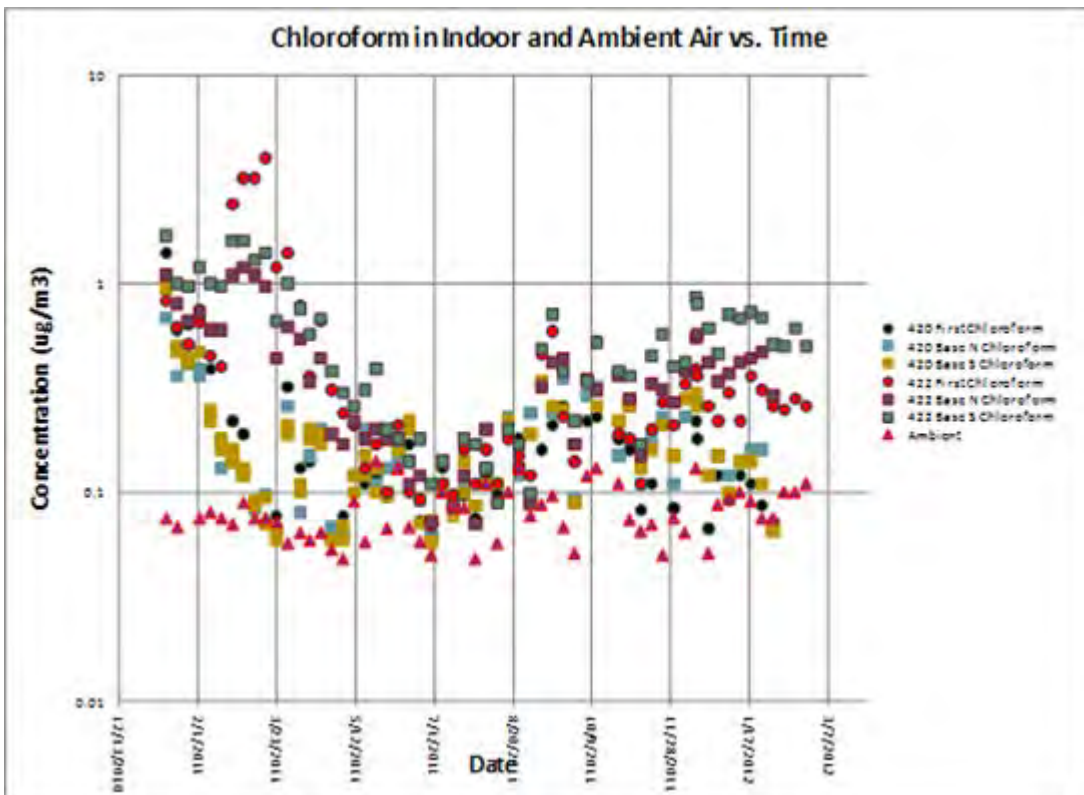

Figure 5-2. Chloroform in indoor and ambient air vs. time (7-day Radiello samples).

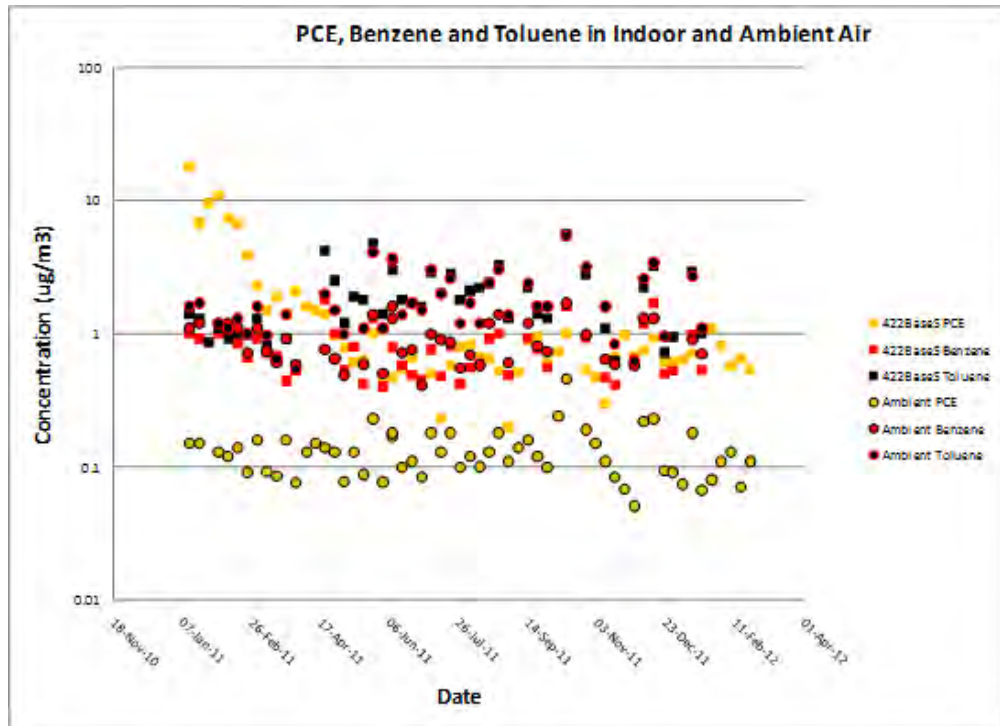

Figure 5-3. PCE, benzene, and toluene in indoor and ambient air.

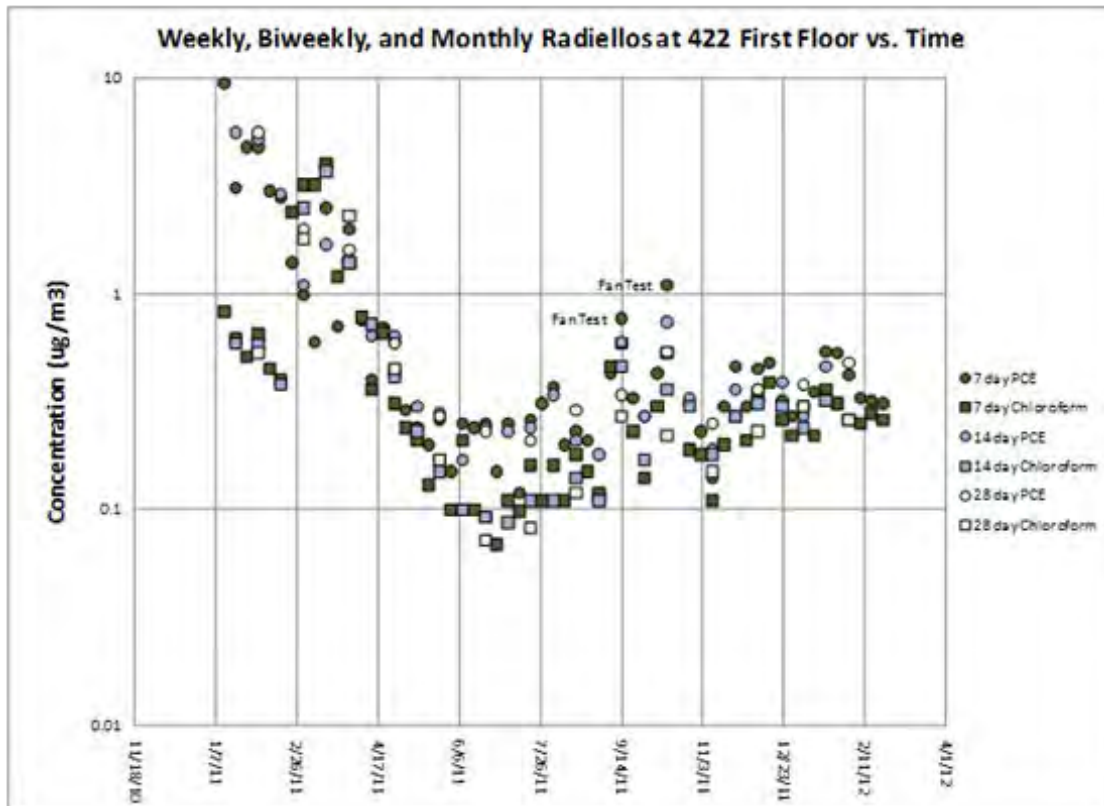

Figure 5-4. PCE and chloroform in 422 first-floor indoor air; weekly, biweekly, and monthly duration Radiello samples.

samples more dramatically than the longer duration samples (see Section 12.2). The comparison of absolute concentrations measured by samplers of different durations is discussed in Section 9.

5.1.2 Subslab Soil Gas

Data are presented in this section from seven subslab ports (SSPs), numbered 1 through 7, and four wall ports (WPs), numbered 1 through 4. On the 422 side of the house are SSP1, 2, and 4 and WP1 through 3. Given its low initial concentration and nearness to soil gas port (SGP) 10-6, SSP2 was sampled relatively infrequently. On the 420 side of the house are SSP3, and 5 through 7, and WP4. The basements of both sides of the duplex are each divided into thirds in the interior. There is generally one subslab port per basement division, with one section on the 420 side having two. The wall ports are located on the exterior walls of the duplex. WP1 and 3 are each located in the centers of the north and south ends of the 422 basement, and WP-2 is in the center of the east side of the 422 basement. WP-4 is located in the center of the west wall of the 420 basement.

Figures 5-5 and 5-6, and 5-7 and 5-8 are chloroform and PCE concentrations versus time, respectively, with the **Figures 5-6 and 5-8** representing intensive sampling periods.¹ For chloroform as shown in **Figure 5-5**, most of the ports on the unheated 420 side (the various crosses and the square) are generally stable for most of the duration of the project. Notable exceptions are the vertical alignment of data points on the plot (indicating concentration variability over a short time period) That occur during intensive periods of sampling.

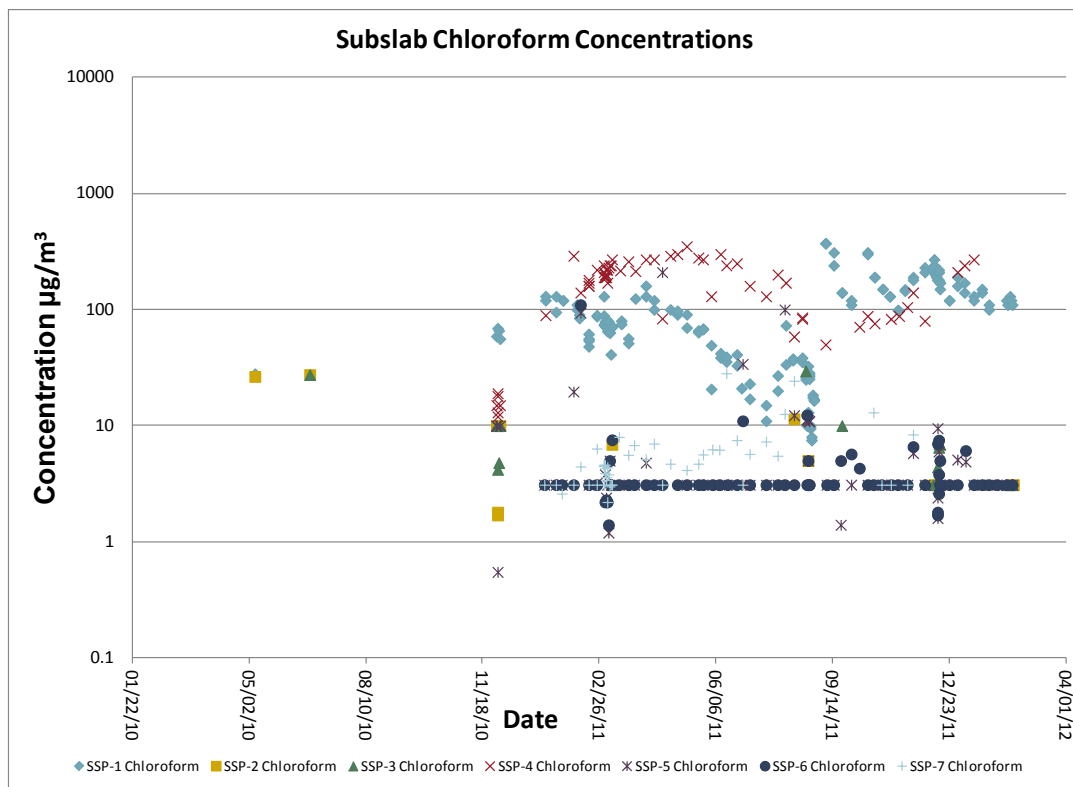

Figure 5-5. Plot of subslab chloroform concentrations vs. time.

¹ During the normal times, the subslab samples were collected during regular daytime working hours, while the intensive periods involved two shifts of personnel, allowing up to three samples to be collected, generally early morning, midday, and evening.

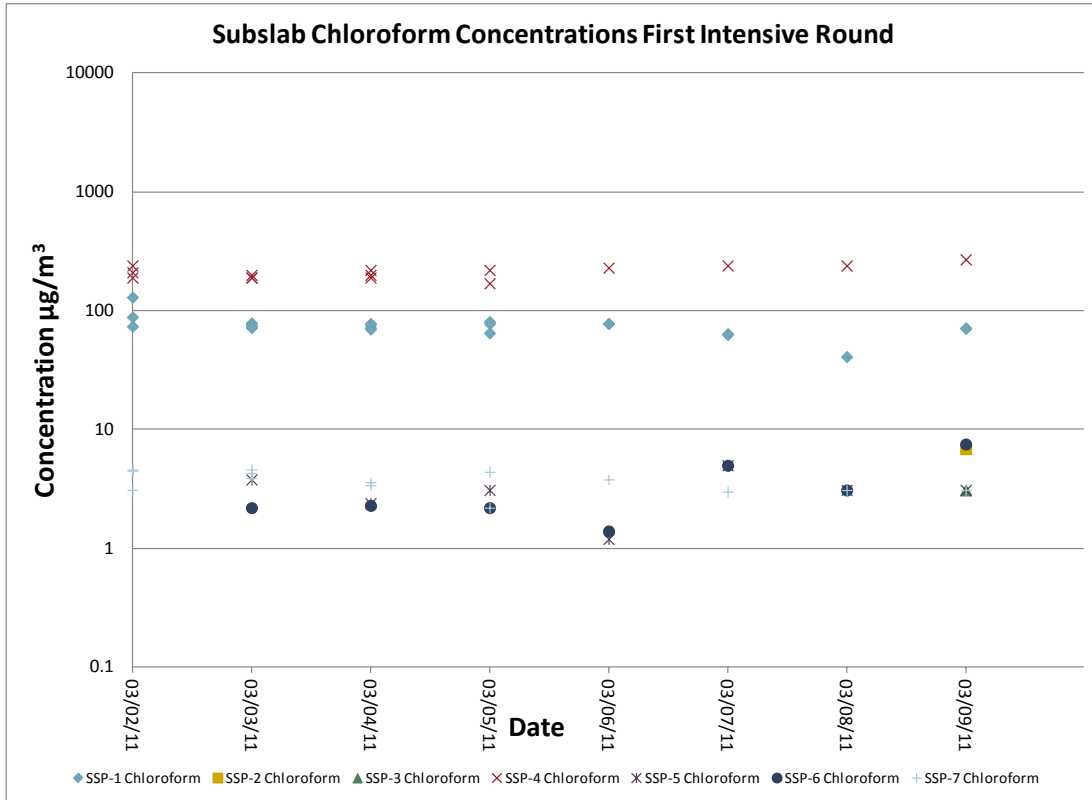

Figure 5-6. Plot of subslab chloroform concentrations vs. time, first intensive sampling period.

This may indicate that there is a diurnal pattern in the subslab sampling that is only perceptible during the intensive periods (Figures 5-6 and 5-8).² Another notable observation on the 420 side occurred from July 14, 2011, to August 3, 2011, between the time when thieves stole the house air conditioners (ACs) (both sides) and when they were replaced (422 side). Chloroform approached its highest levels on the 420 side during this time. Chloroform on the 422 side (shown in Figure 5-5 as the circles, diamonds, and triangles) traces a rough sinusoidal trend over months, although the different ports are somewhat out of phase. These trends generally show lows during the warmer months (SSP-1 and SSP-4 seem to both reach a minimum in August/September 2011 and highs during cooler months). It is also notable that the concentration increases abruptly two orders of magnitude between August 27 and September 8, 2011, a period of time during which a series of fan tests (coded B and F) intended to simulate the stack effect expected under winter conditions were conducted (as discussed in Section 12.2). Another smaller rise occurs from September 30 to October 14. Fan test “I” was conducted from October 6 to October 14.

In both cases, the subslab ports on the 422 side have higher concentrations of PCE and chloroform than those on the 420 (unheated) side of the structure. In Figure 5-7, SSP PCE concentrations versus time more prominently display a simple pattern of high and low concentration changes during warmer and cooler months across the range of ports. Most of the ports on the 420 side of the house and SSP-4 on the 422 side show highs during the warmer months and lows during the cooler months. A notable exception is SSP-1, which shows the opposite trend to all the others.

² During normal times, the subslab samples were collected during regular daytime working hours, while the intensive periods involved two shifts of personnel, allowing up to three samples to be collected, generally early morning, midday, and evening.

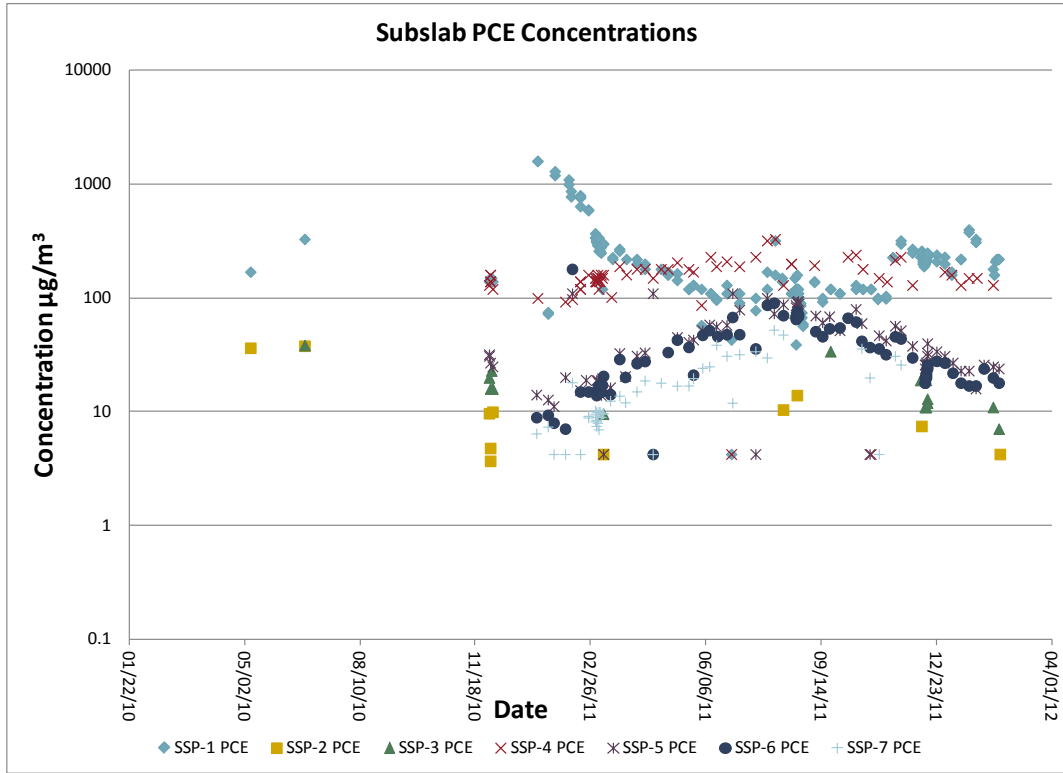

Figure 5-7. Plot of subslab PCE concentrations vs. time.

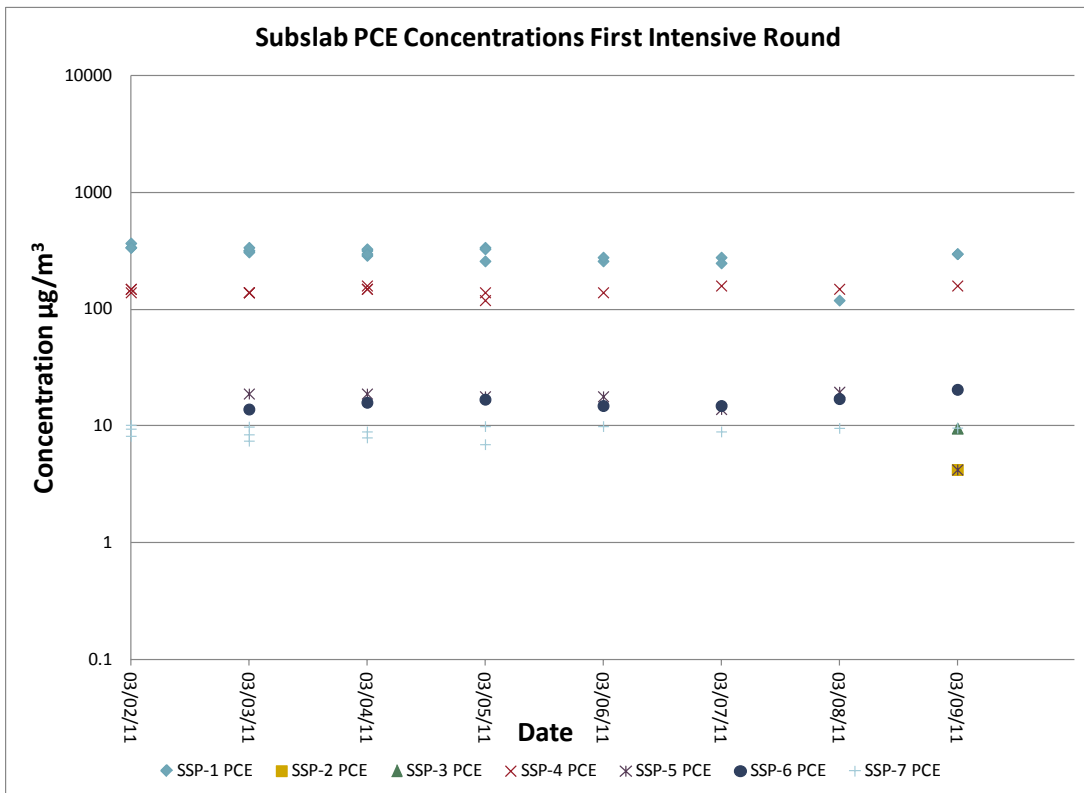

Figure 5-8. Plot of subslab PCE concentrations vs. time, first intensive sampling period.

Neither compound when graphed for the wall ports (**Figure 5-9** nor **Figure 5-10**) shows the same clear patterns of highs and lows found during the changing seasons in **Figures 5-5** and **5-7**. **Figure 5-9** plots chloroform concentrations at the four WPs versus time. Most ports are generally stable throughout the project time period. As with the subslab samples, vertical alignments of data points on the plot occur during intensive rounds. These chloroform levels do not show the same kind of spike during the period when the ACs were stolen as for SSP chloroform. Highs for WP-3 in January through February and September through October 2011 seem to suggest influence of the snow and ice and fan testing, respectively. The greater temporal fluctuations of the wall ports as compared with the subslab ports may be attributable to their more shallow depths (approximately 1.5 ft bls).

Figure 5-10 plots PCE concentrations at the four WPs versus time. Most are generally stable over time. Vertical alignments of data points are seen during the intensive rounds of sampling. The high concentrations of PCE in WP-3 at the beginning of the project could be due to the snow and ice capping event during the severe winter of January and February 2011. Highs in September and October might be attributable to the fan testing during that time.

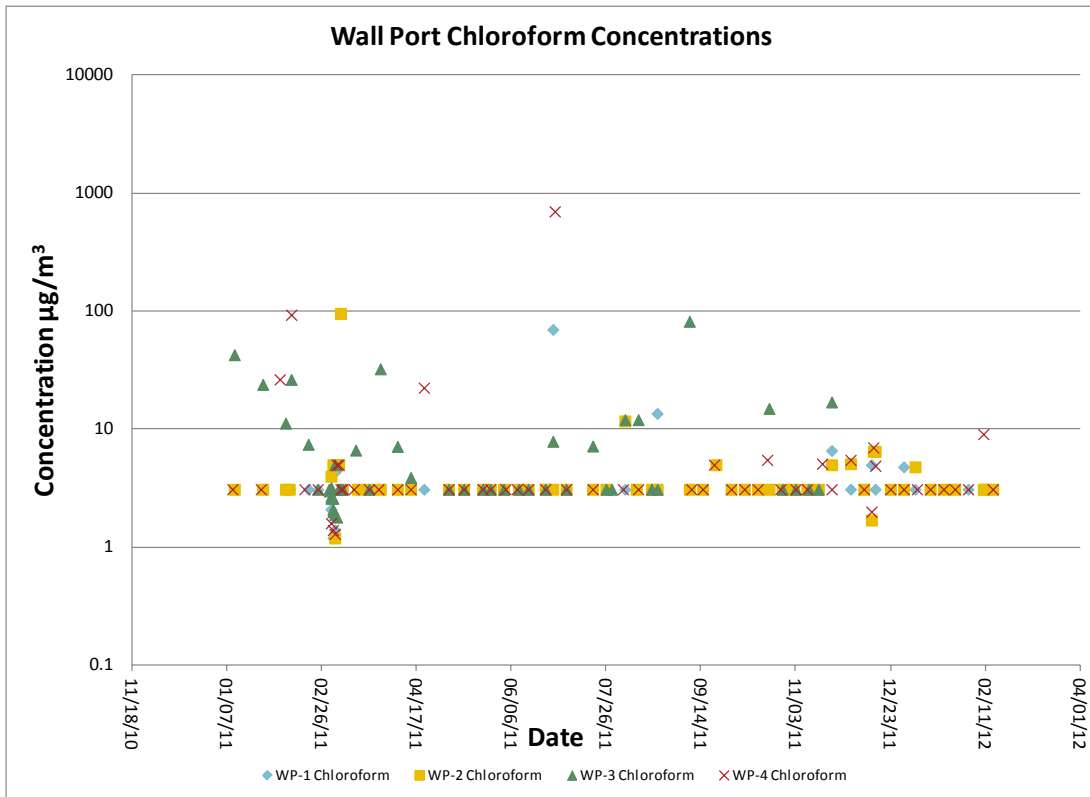

Figure 5-9. Plot of wall port chloroform concentrations vs. time.

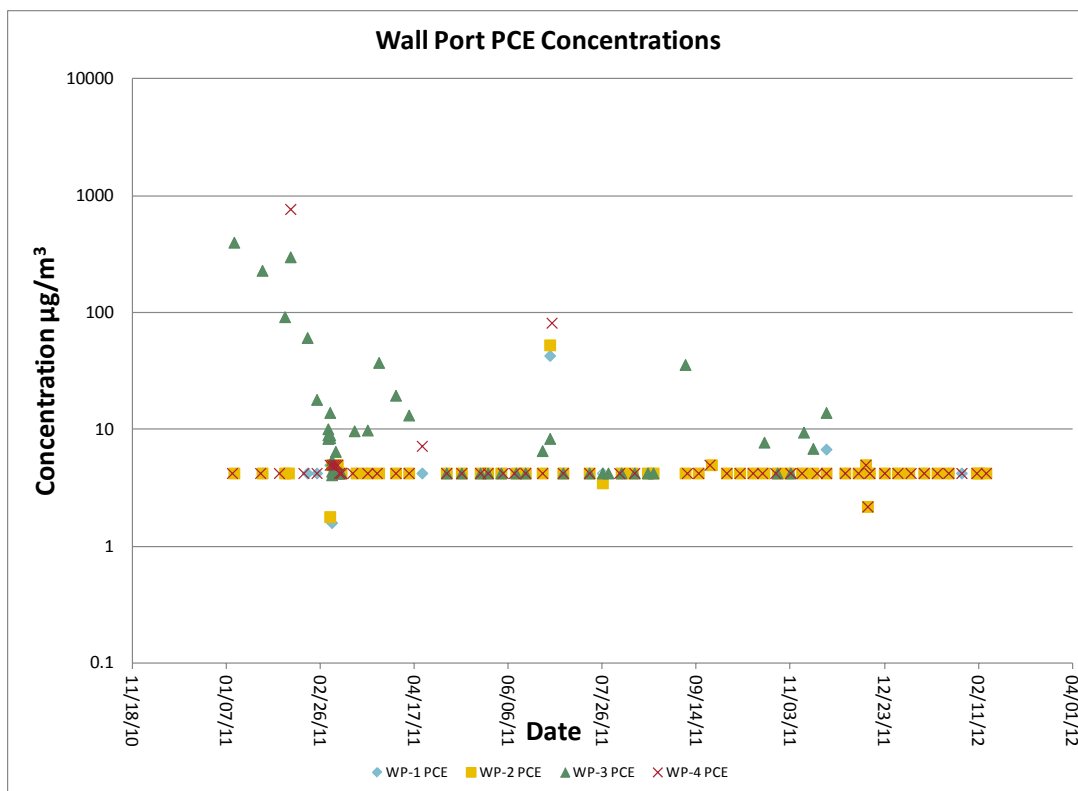

Figure 5-10. Plot of wall port PCE concentrations vs. time.

5.1.3 Shallow and Deep Soil Gas

A series of 12 nested SGPs surround the 422/420 house or originate in the basements of either side of the duplex. The five depths at each of the external nested locations are as follows: 3.5 ft bgs, 6 ft bgs, 9 ft bgs, 13 ft bgs, and 16.5 ft bgs. At the internal nested locations there are only four depths; the 3.5-ft depth is omitted because the basement floor is at ~5 ft bgs. External to the house, there are seven nested locations, notated SGP1 through 7. Internal to the house are the nested locations notated SGP8 through 12. Each individual port is notated based on its location and its depth (e.g., SGP1-3.5 for the 3.5-ft depth at the SGP1 location; see **Figures 5-11** through **5-32**). Groundwater levels varied throughout the project but remained high enough most of the time to render the 16.5-ft probe depths inaccessible for soil gas sampling for much of the project.

Concentrations are generally highest in the deepest ports of each cluster and decrease at shallower depths. This pattern is consistent with expectations for attenuation of vapor intrusion of VOCs originating from a deep source (whether in the vadose zone or groundwater). This attenuation pattern appears to be more pronounced for chloroform (frequently two to three orders of magnitude) than for PCE (generally one order of magnitude).

An analysis of the frequencies of nondetects was performed for each compound by borehole and depth. Of the boreholes outside the house footprint, only SGP1 (just south of the 422 part of the duplex) had less than a 20% frequency of nondetects for both PCE and chloroform (**Table 5-1**).

Table 5-1. Frequency of Nondetects (%) by Soil Gas Point or Cluster

Location	Benzene	Chloroform	Hexane	PCE	Toluene	TCE
SGP1	22	10	69	3	55	66
SGP2	17	31	73	32	58	68
SGP3	20	58	75	76	67	77
SGP4	22	44	75	12	63	79
SGP5	23	31	87	38	74	87
SGP6	24	43	80	26	68	84
SGP7	23	38	81	25	71	85
SGP8	23	4	77	4	63	67
SGP9	23	5	74	0	61	71
SGP10	29	28	78	2	69	81
SGP11	22	14	81	0	70	82
SGP12	27	24	82	2	74	85
SSP-1	10	1	76	0	54	52
SSP-2	0	60	100	40	80	100
SSP-3	20	50	90	0	50	90
SSP-4	18	6	79	2	61	58
SSP-5	16	51	81	3	68	86
SSP-6	23	63	80	1	65	87
SSP-7	15	15	68	9	62	66
WP-1	21	69	82	79	66	82
WP-2	25	71	81	83	68	83
WP-3	16	40	82	32	76	70
WP-4	17	66	79	81	74	83

All of the wall ports have more than 20% nondetects for all compounds except benzene (**Table 5-2**).

Table 5-2. Frequency of Nondetects by Depth and Compound

depth	Benzene	Chloroform	Hexane	Tetrachloroethene	Toluene	Trichloroethene
Wall Port	20	62	81	70	71	80
Sub-Slab	15	24	78	2	60	67
3.5	24	68	79	76	70	80
6	17	29	77	11	61	74
9	21	25	74	12	62	73
13	35	8	88	7	79	90
16.5	9	2	54	3	46	59

Nondetects are infrequent (<20%) in almost all the SSPs for PCE but more frequent for chloroform and the 420 side of the duplex. Interestingly many subslab ports are consistently detectable (>80%) for benzene as well. Benzene is also consistently detectable at the 6 and 16.5-ft depth intervals. For the trend in nondetects by depth, we see about what we would expect for a deep vapor intrusion source; there are fewer nondetects at lower depths. As mentioned before, PCE is under 20% nondetects at the subslab level (depth = 5 ft) and from 6 ft down in the deeper soil gas samples. Chloroform had fewer than 20%

nondetects only at depth deeper than 13 ft. Benzene was under 20% nondetects only at the deepest depth of 16 ft. No other compounds were consistently detectable.

Thus, the shallowest depths (3.5 ft and 6 ft) were generally the most stable, with little fluctuation because most results were below the detection limit. The 9-ft depths had periods of stability as well (see **Figures 5-15, 5-16, 5-21, 5-27, 5-29, and 5-31**). Notable exceptions to the shallow stability can be found at SGP1 and, to differing degrees, all of the indoor ports, SGP8 through 12 where the shallow concentrations were higher and thus less affected by nondetects. At each of those ports, shallow concentrations seem to partially track the seasonal variations of the deeper ports (see **Figures 5-11, 5-12, and 5-25 – 5-32**). At SGP3 and 4, the deeper ports are often low or stable (see **Figures 5-15 through 5-18**).

Many of the deeper ports at each location (9 ft through 13 ft, sometimes 16.5 ft) show what appears to be a rough cycle responding to seasonal changes (see **Figures 5-19, 5-20, 5-23, 5-24, 5-25, and 5-29**), that is, concentrations are higher in the cooler months and lower in the warmer. SGP3 and 4 are too diffuse to show much of a trend (see **Figures 5-15 through 5-18**). SGP1 and 2 show the opposite trend, especially for chloroform at SGP1-13 and PCE at SGP2-9 (see **Figures 5-11 and 5-14**). To a degree, a negative trend can also be seen for PCE at SGP8-6, and chloroform at SGPs 11-13 and 12-13 (see **Figures 5-26 and 5-30**).

Some prominent points among the figures might be attributed to natural or project-related phenomena. Although samples were taken multiple times per week, and in some cases per day, during the intensive rounds (yielding as many as >12 successive samples at some locations during a week), there were no discernable or notable trends in the data. This suggests that there is probably not a strong diurnal variance in subsurface soil gas concentrations at this duplex and that the frequency of sampling (and thus the artificial volumetric flow in the subsurface induced by frequent sampling) does not appear to be significant (for example, see **Figures 5-33 and 5-34**). High concentrations found at the beginning of the project but tapering off toward the spring could be due to the period of heavy snow and ice in the very cold winter of January and February 2011 (for example, see **Figure 5-14**). In all of the PCE figures (even numbered **Figures 5-12 through 5-32**), there is a cluster of points offset above the long term from mid-May to early July visible. This is also visible in the wall port PCE plot presented in the previous section. It is possible that this clustering resulted from drastic temperature fluctuations that occurred during that time. For example, the low on May 16, 2011, was 43.8 degrees F, and the high roughly 2.5 weeks later was 95.5 degrees F on June 4, 2011.

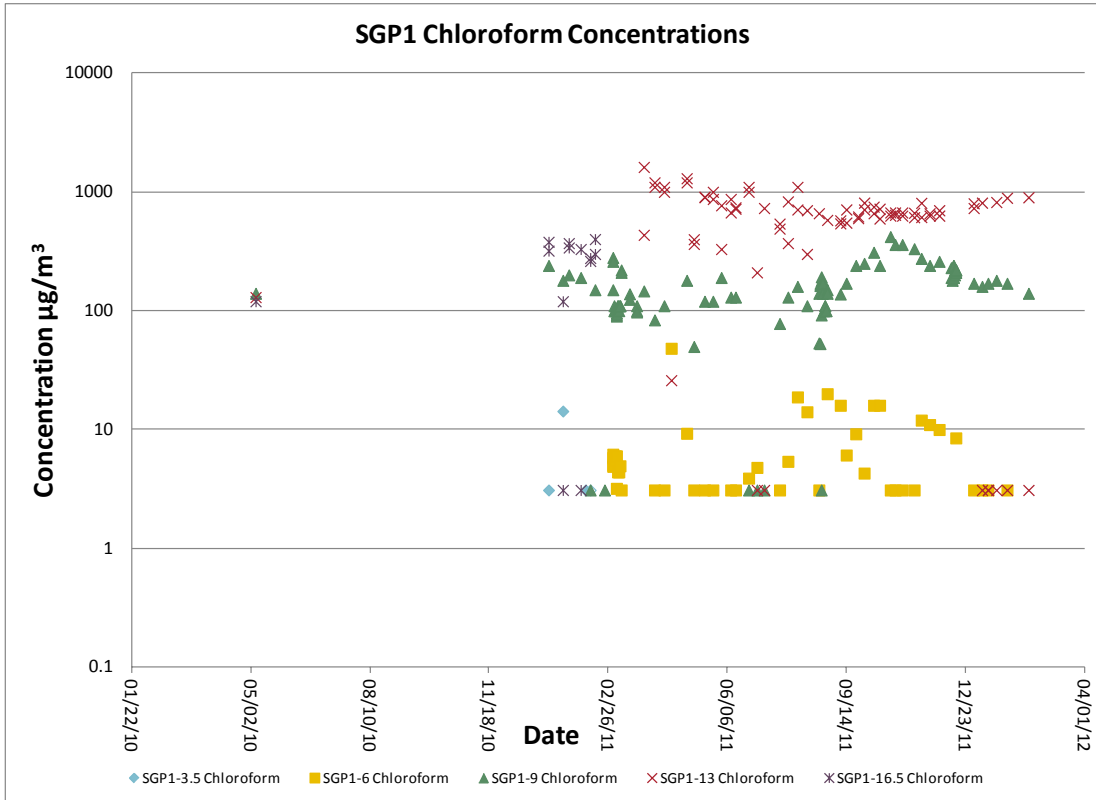

Figure 5-11. Chloroform concentrations at each of the SGP1 ports vs. time.

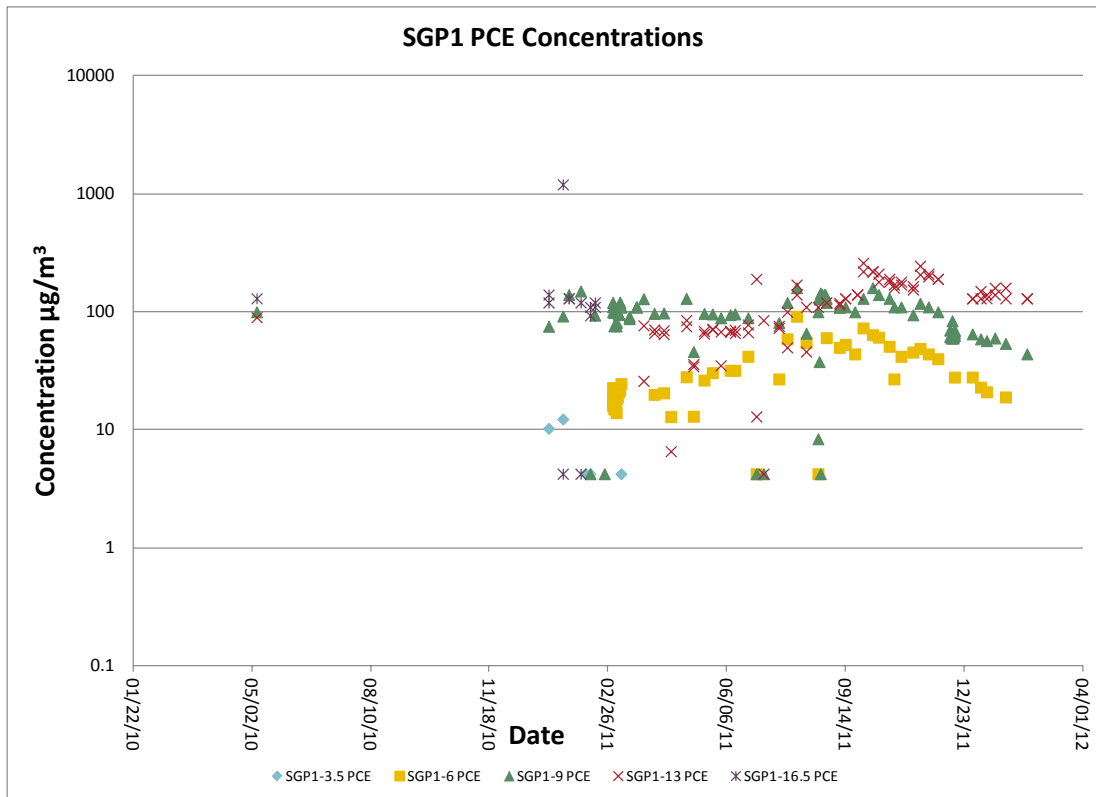

Figure 5-12. PCE concentrations at each of the SGP1 ports vs. time.

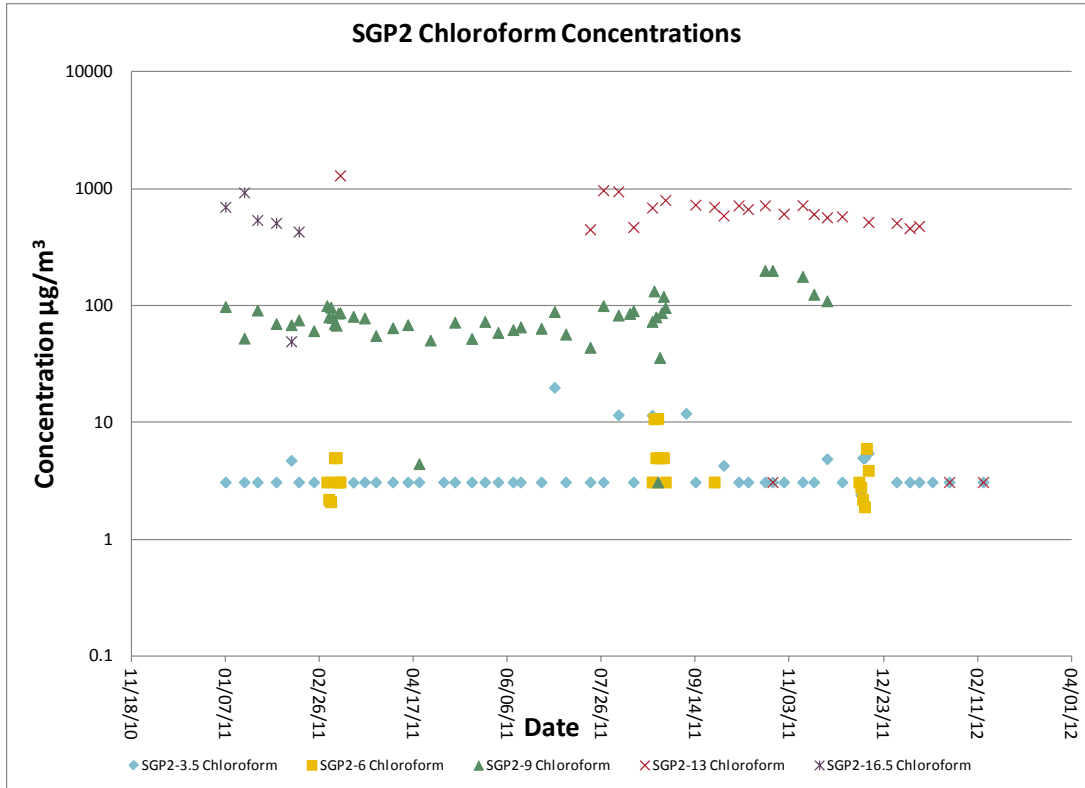

Figure 5-13. Chloroform concentrations at each of the SGP2 ports vs. time.

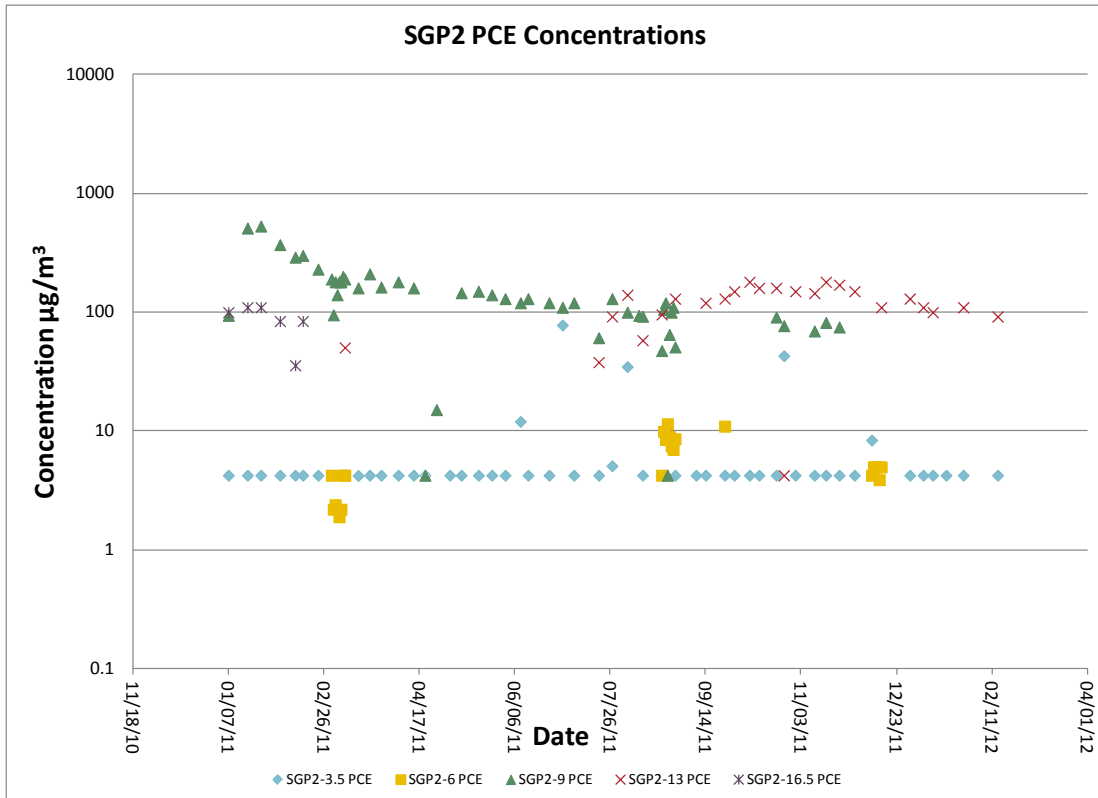

Figure 5-14. PCE concentrations at each of the SGP2 ports vs. time.

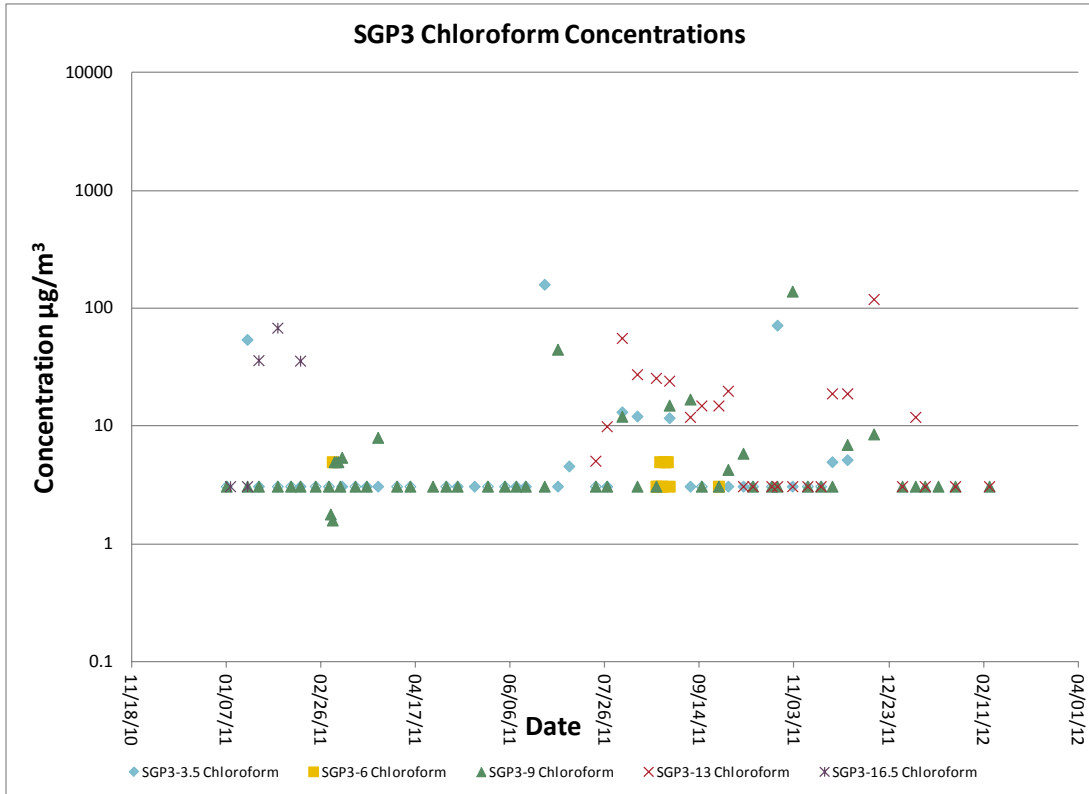

Figure 5-15. Chloroform concentrations at each of the SGP3 ports vs. time.

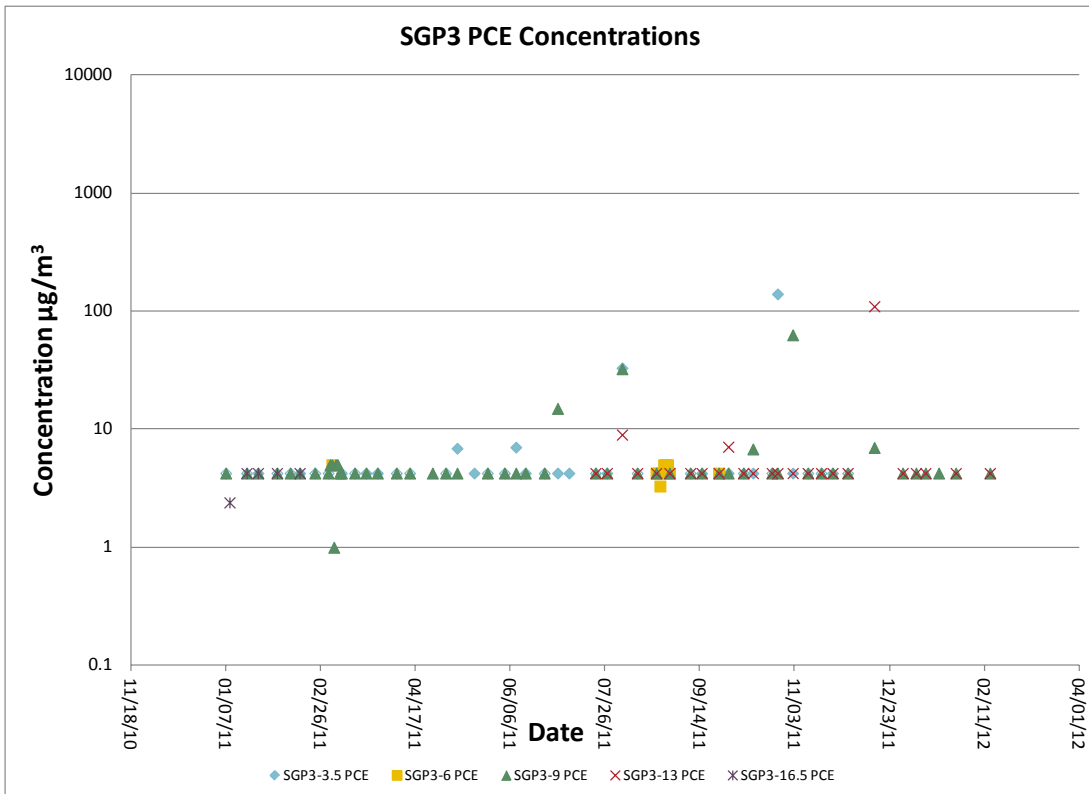

Figure 5-16. PCE concentrations at each of the SGP3 ports vs. time.

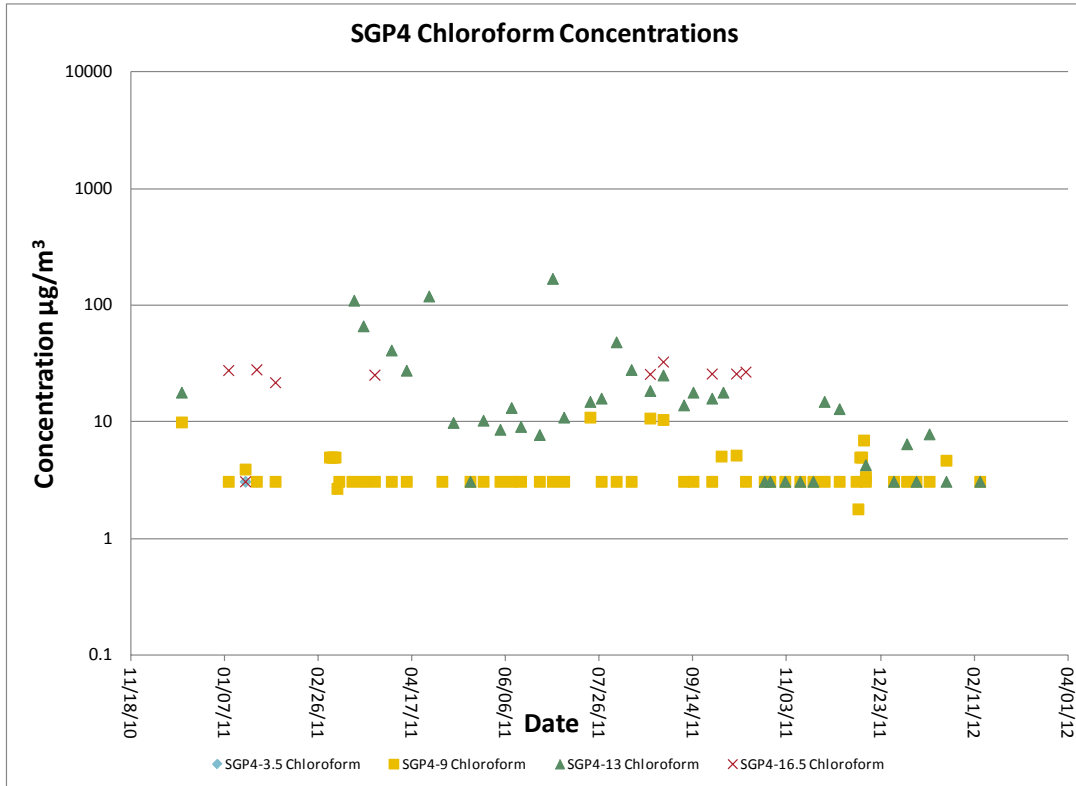

Figure 5-17. Chloroform concentrations at each of the SGP4 ports vs. time.

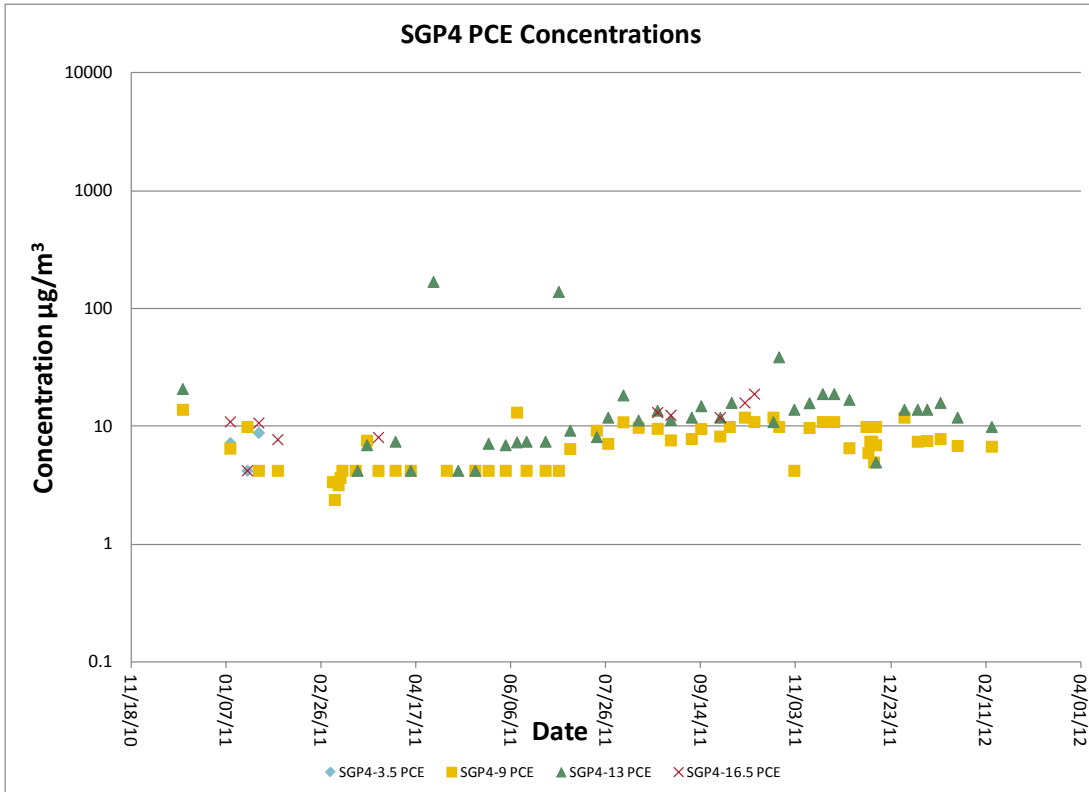

Figure 5-18. PCE concentrations at each of the SGP4 ports vs. time.

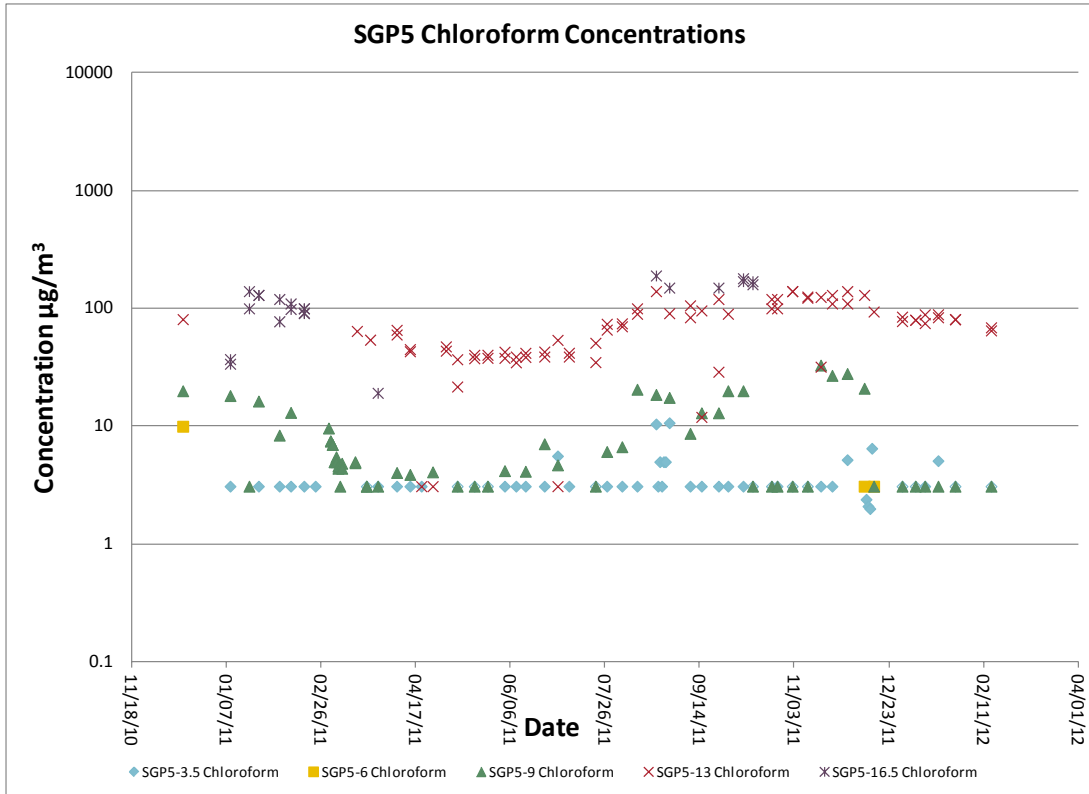

Figure 5-19. Chloroform concentrations at each of the SGP5 ports vs. time.

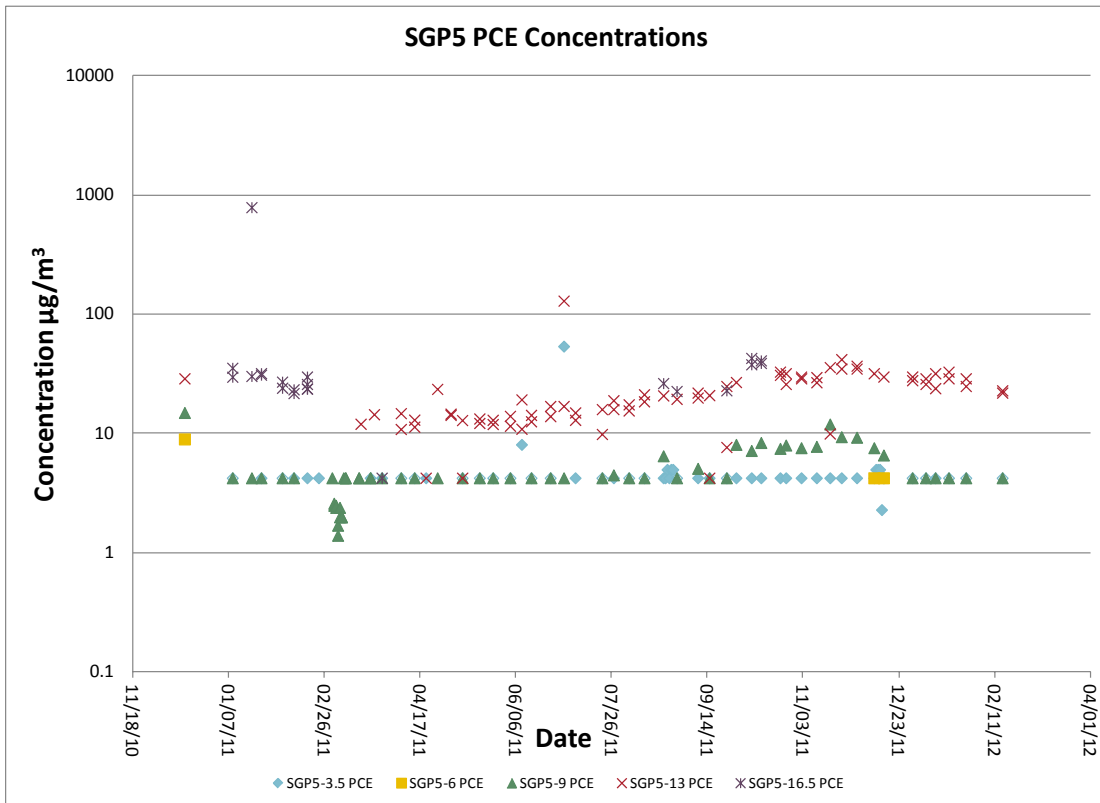

Figure 5-20. PCE concentrations at each of the SGP5 ports vs. time.

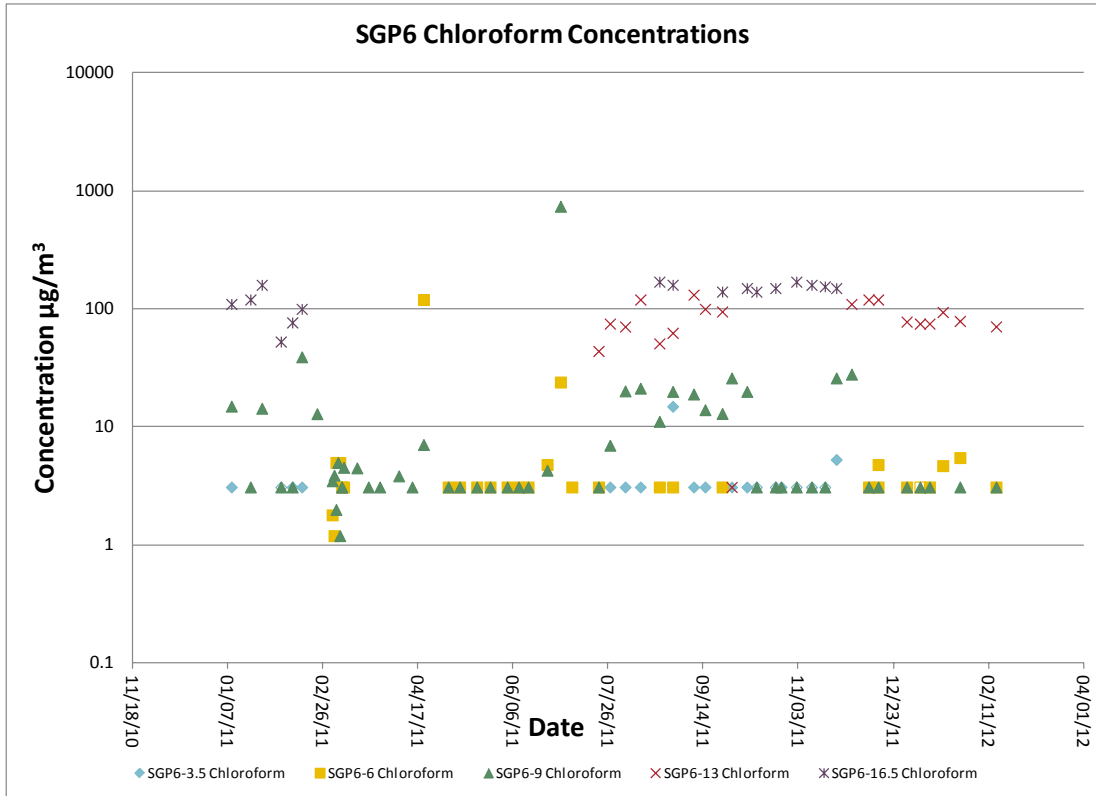

Figure 5-21. Chloroform concentrations at each of the SGP6 ports vs. time.

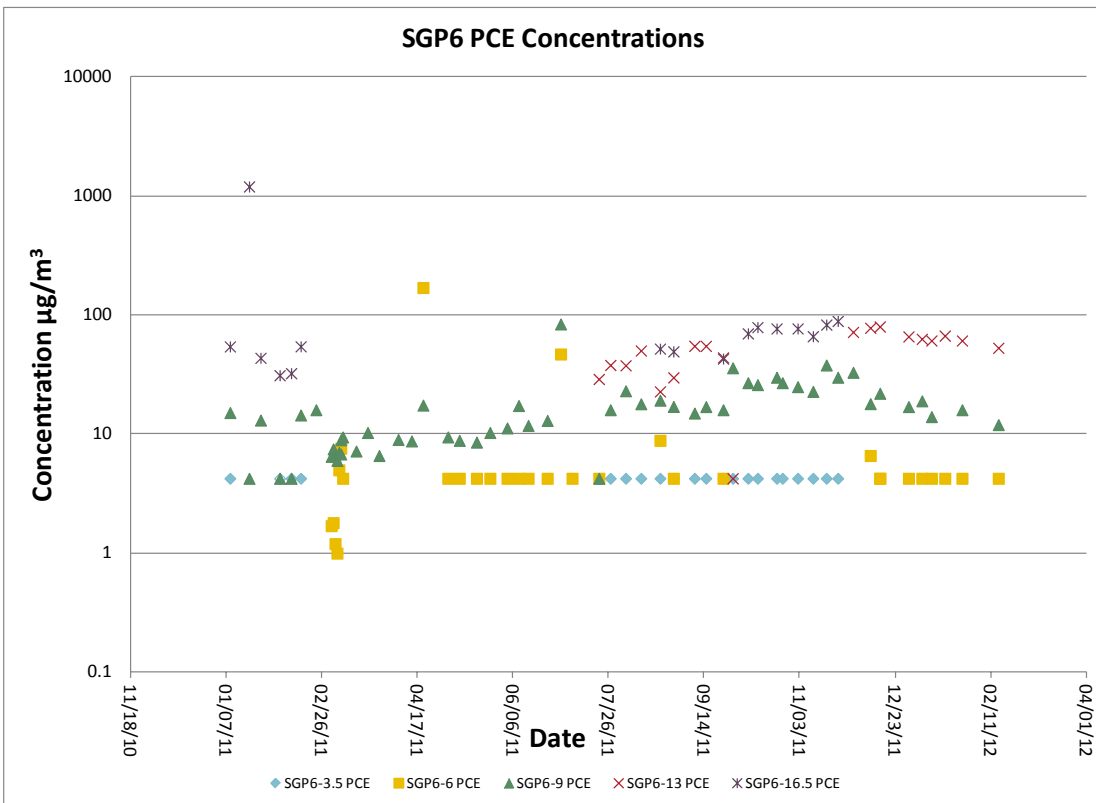

Figure 5-22. PCE concentrations at each of the SGP6 ports vs. time.

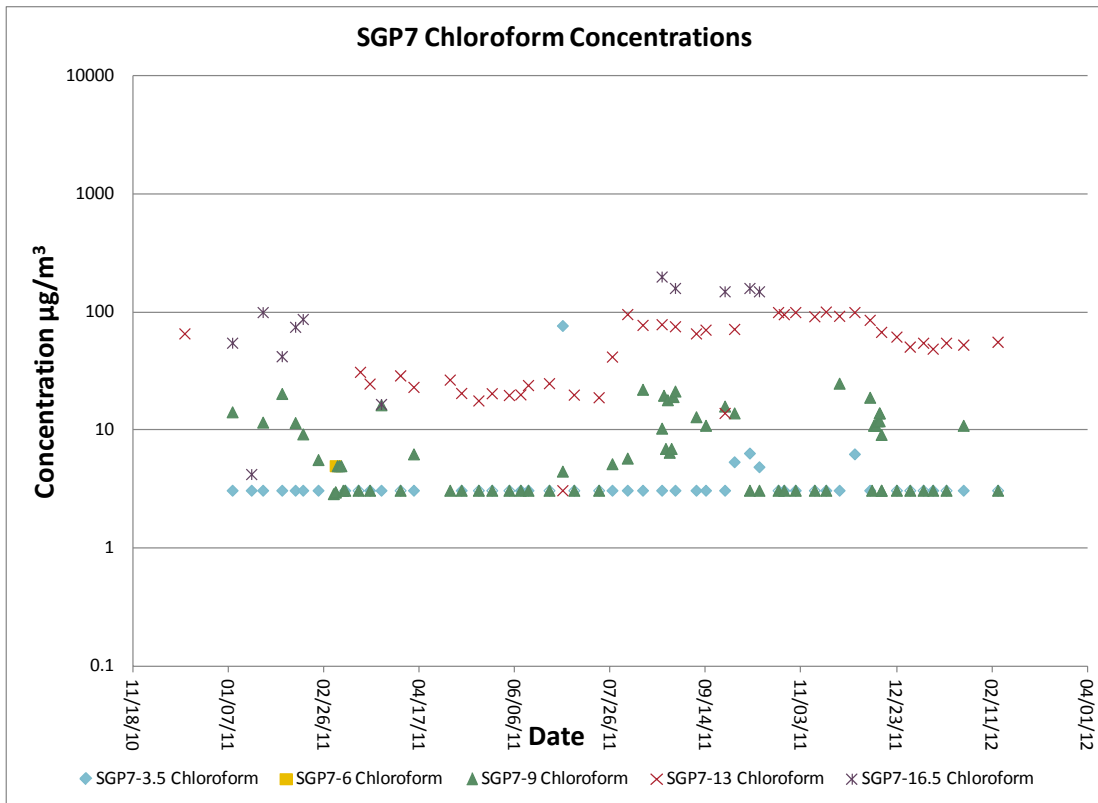

Figure 5-23. Chloroform concentrations at each of the SGP7 ports vs. time.

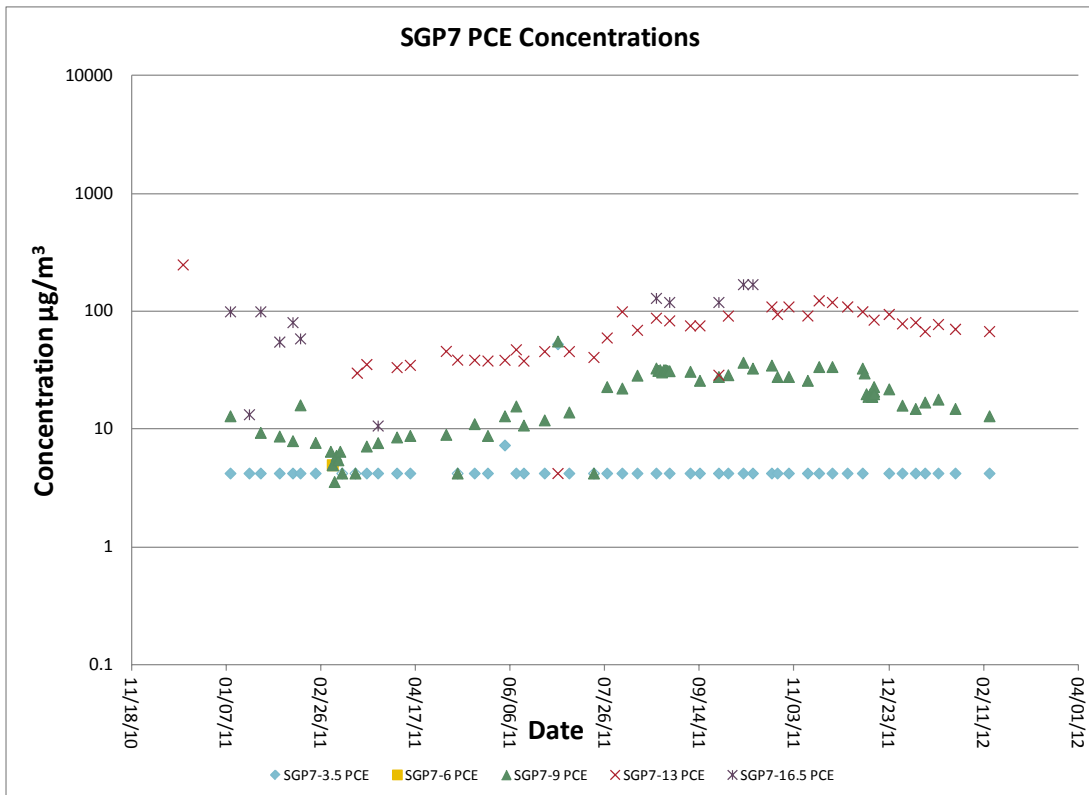

Figure 5-24. PCE concentrations at each of the SGP7 ports vs. time.

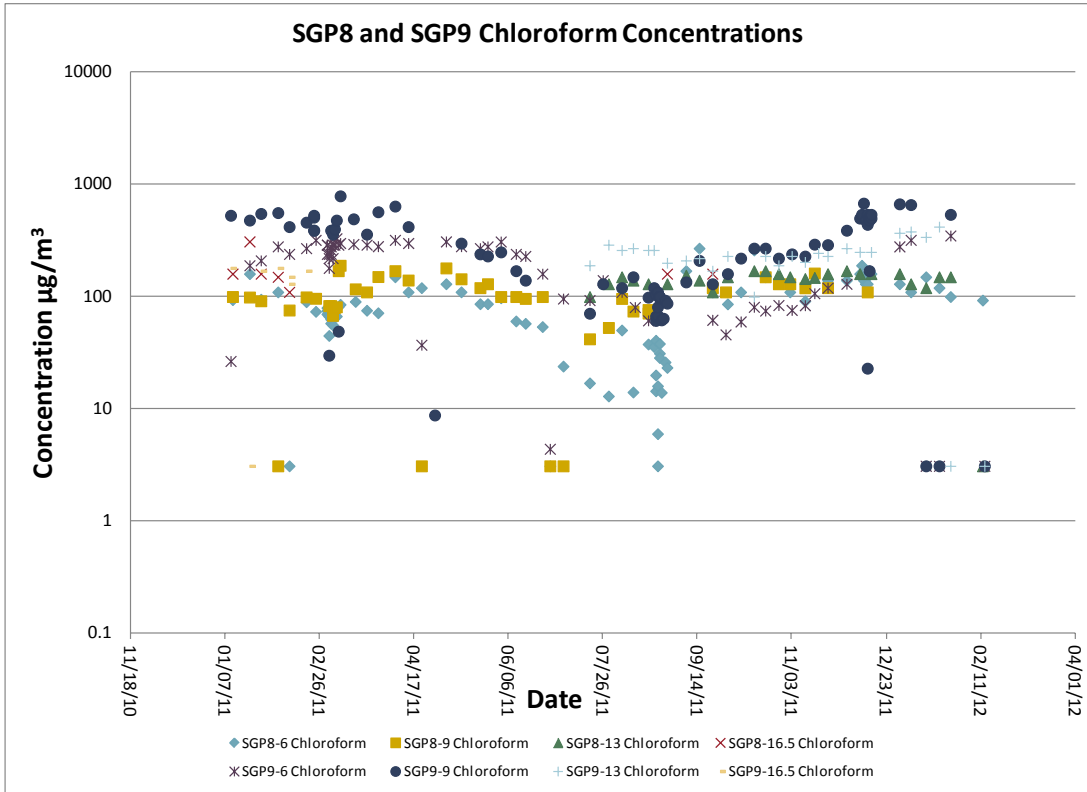

Figure 5-25. Chloroform concentrations at SGP8 and 9 ports vs. time.

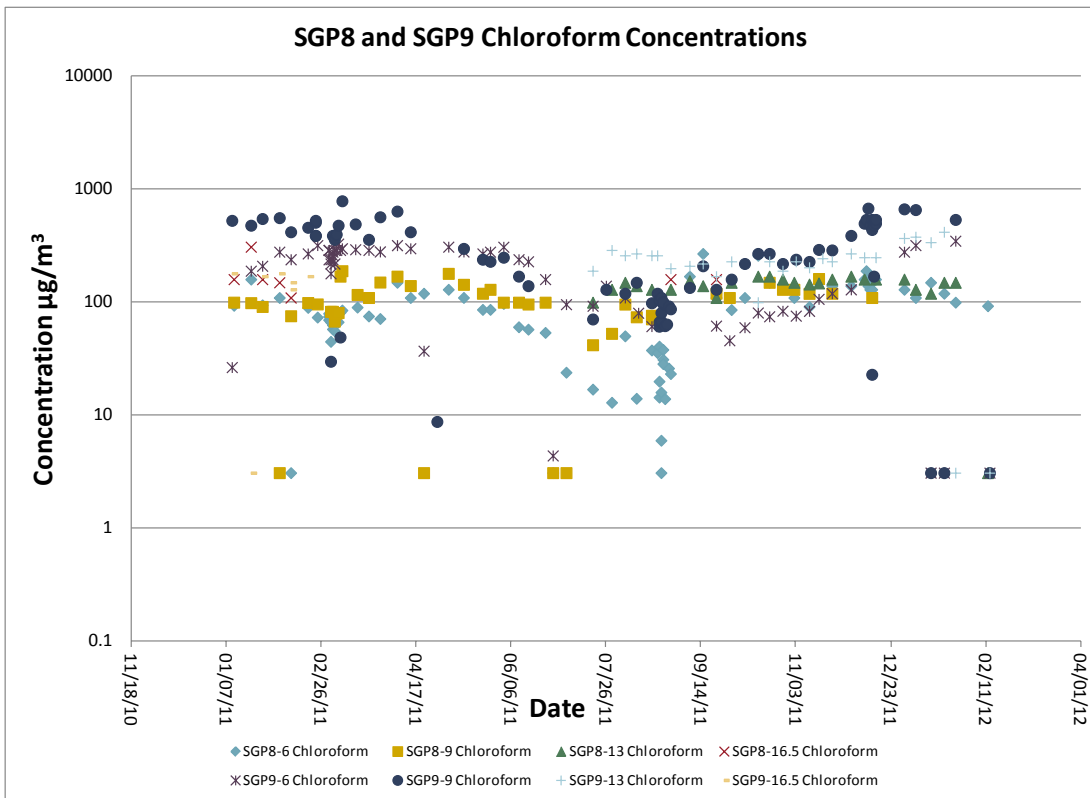

Figure 5-26. PCE concentrations at SGP8 and 9 ports vs. time.

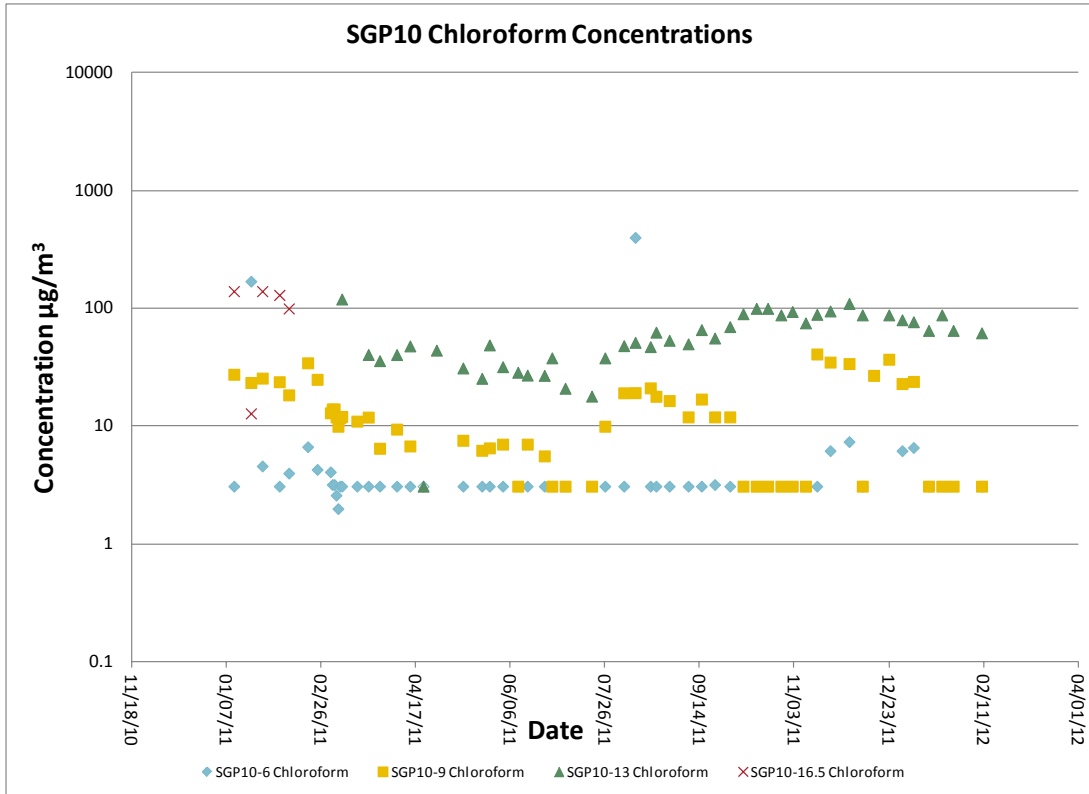

Figure 5-27. Chloroform concentrations at each of the SGP10 ports vs. time.

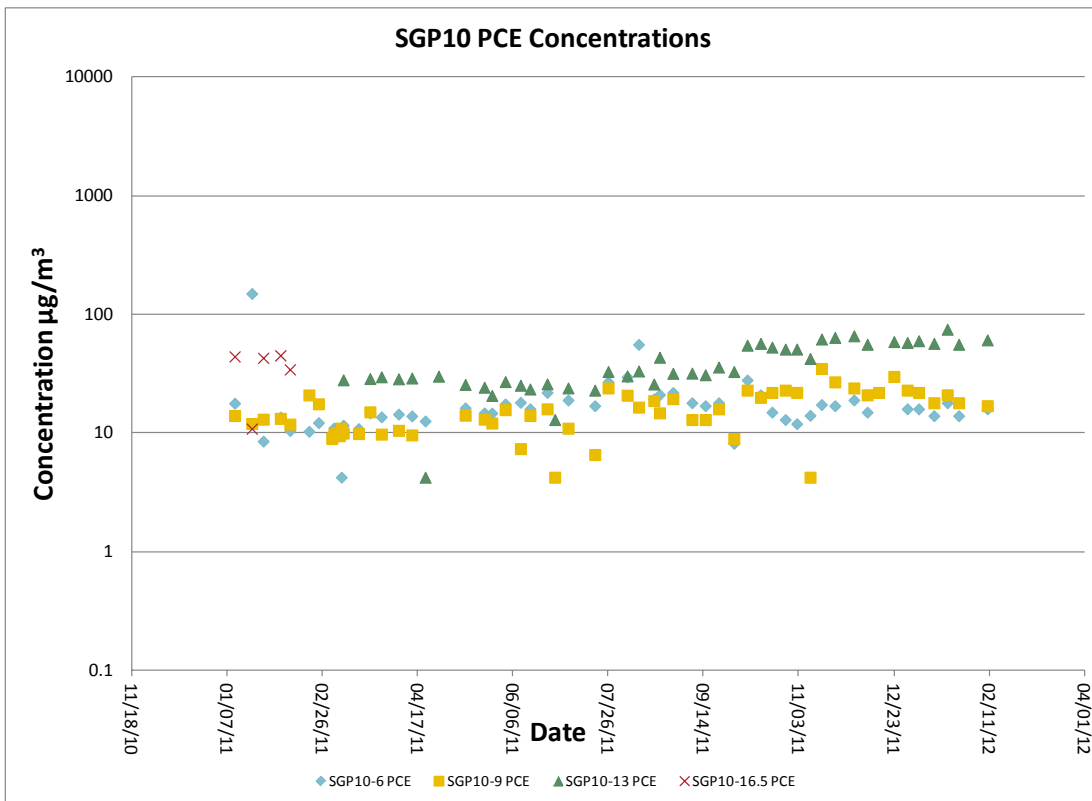

Figure 5-28. PCE concentrations at each of the SGP10 ports vs. time.

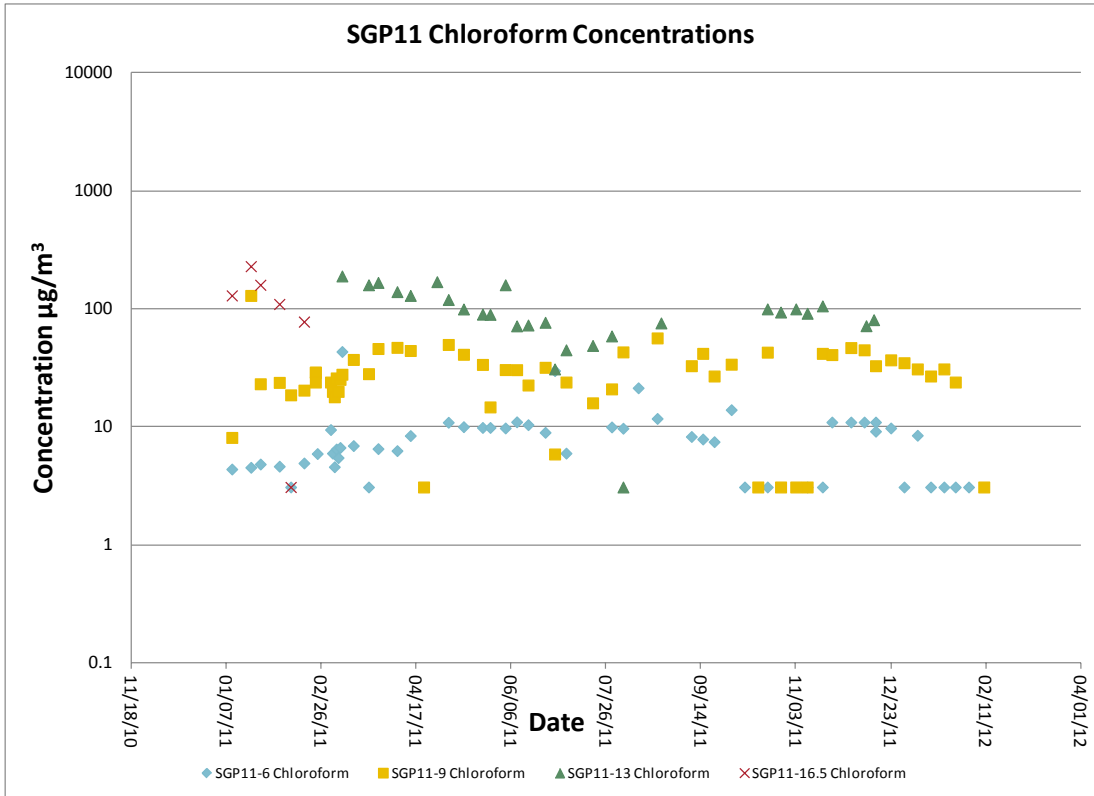

Figure 5-29. Chloroform concentrations at each of the SGP11 ports vs. time.

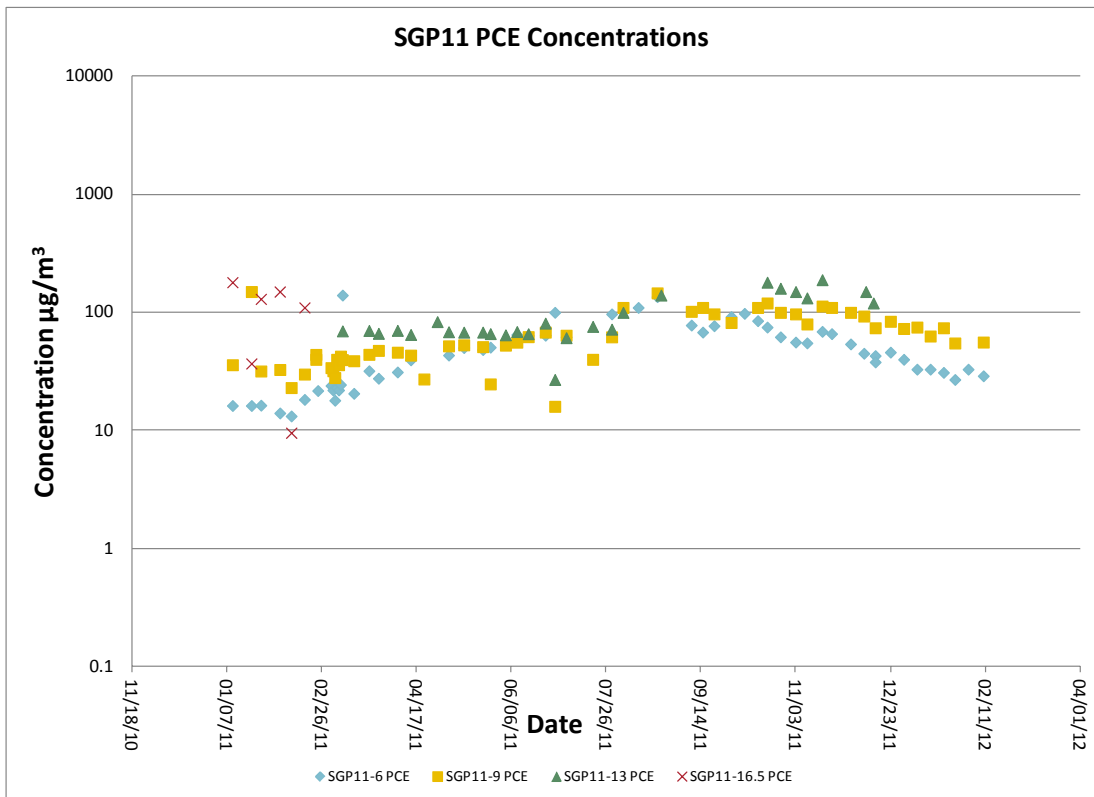

Figure 5-30. PCE concentrations at each of the SGP11 ports vs. time.

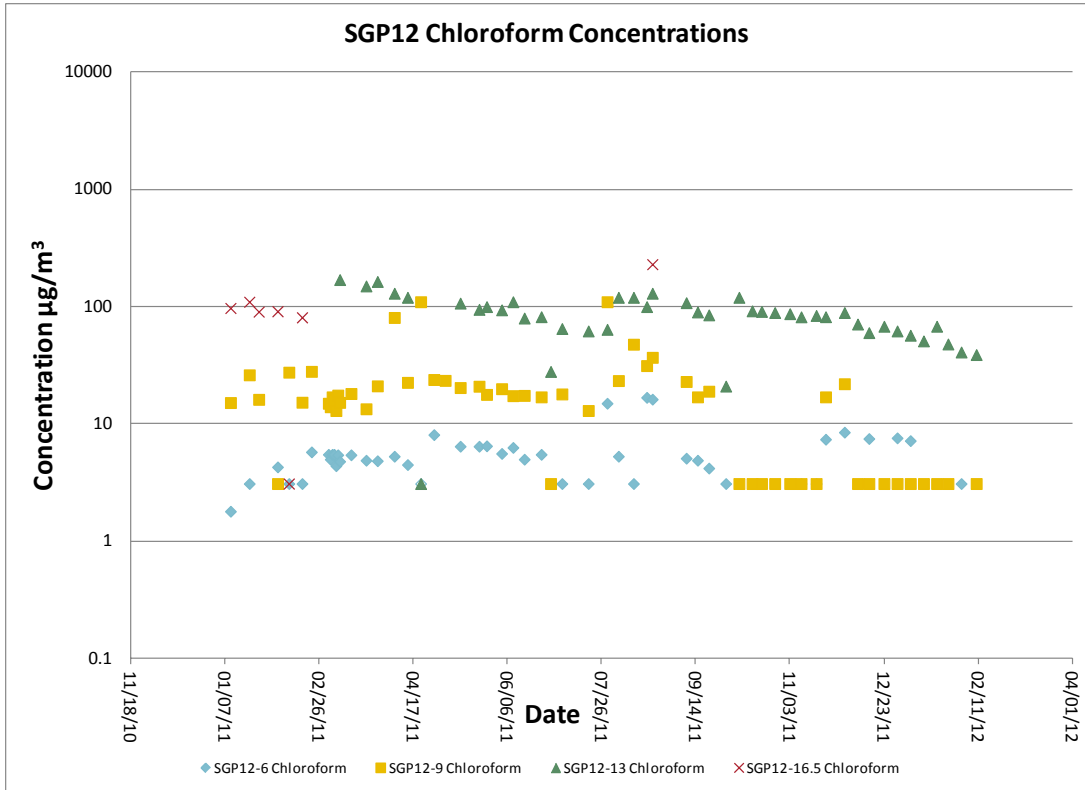

Figure 5-31. Chloroform concentrations at each of the SGP12 ports vs. time.

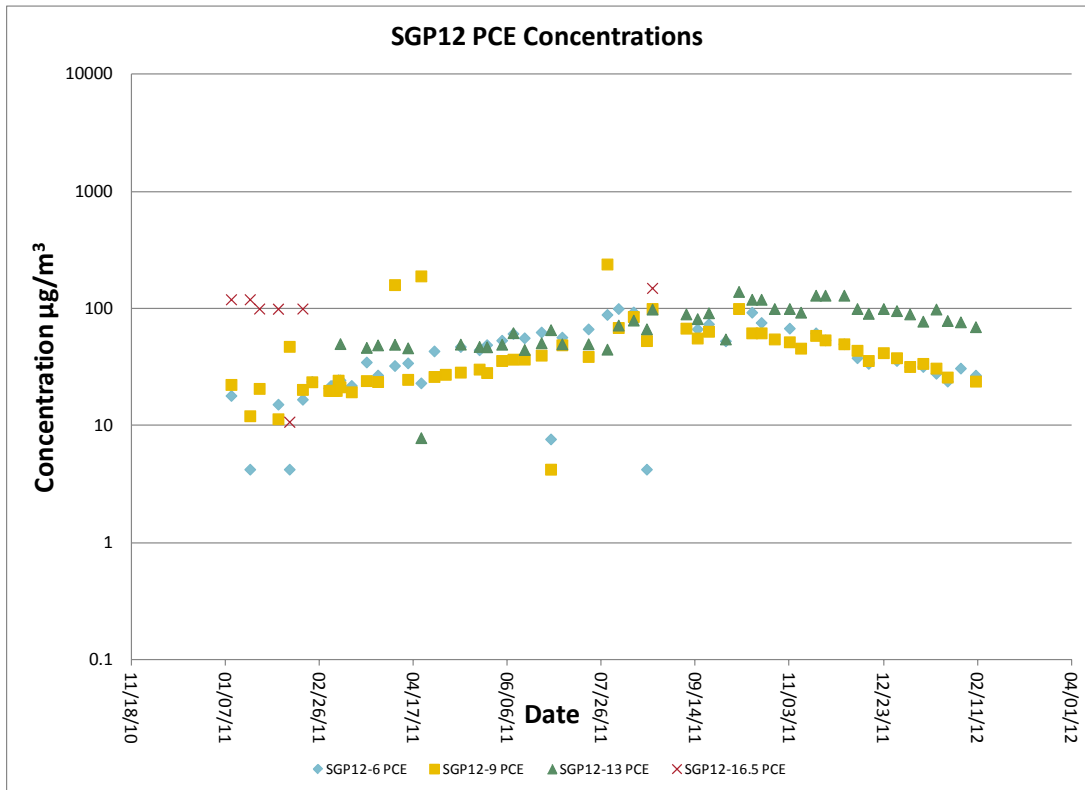

Figure 5-32. PCE concentrations at each of the SGP12 ports vs. time.

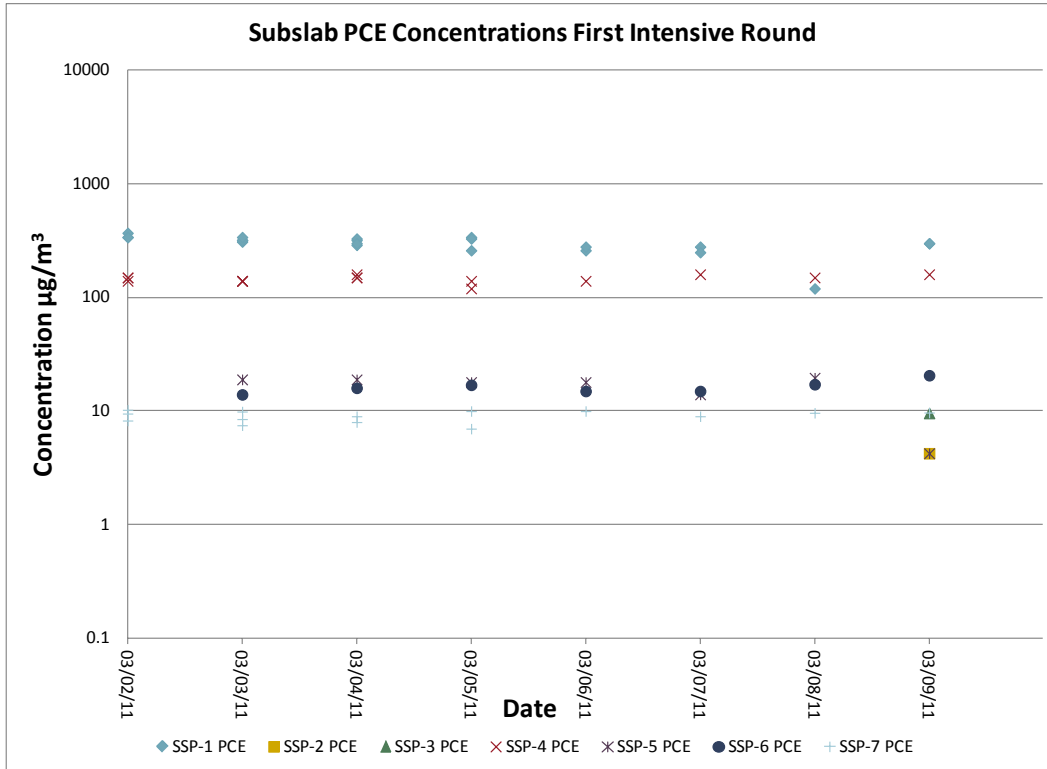

Figure 5-33. Subslab PCE concentrations over a 1-week period during the first intensive round.

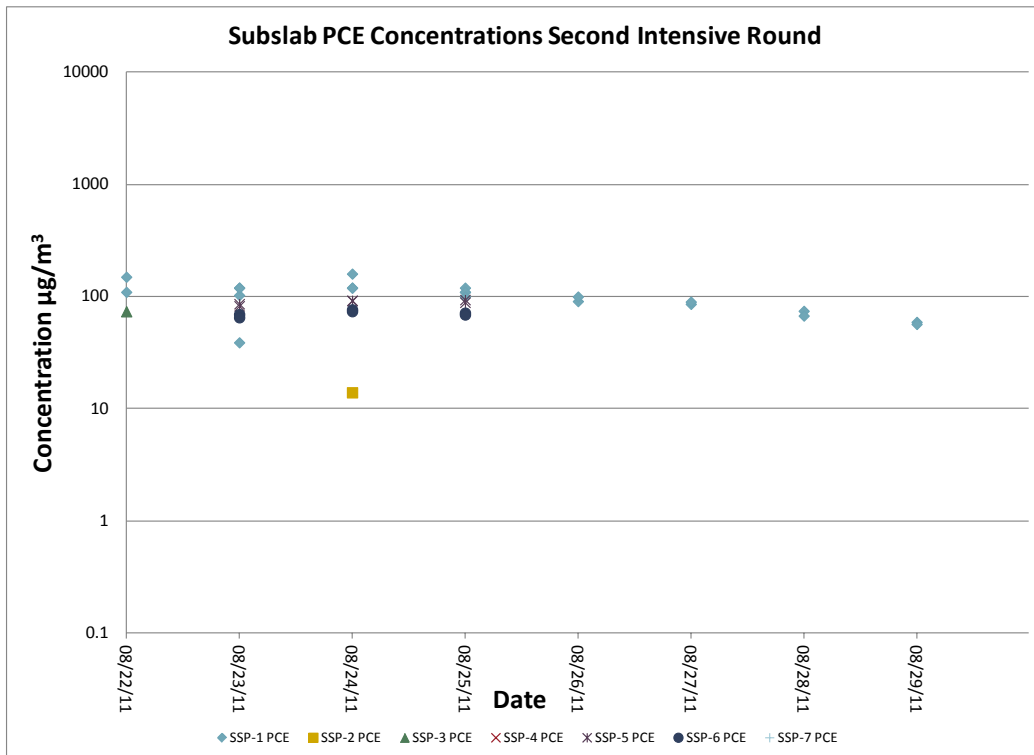

Figure 5-34. Subslab PCE concentrations over a 1-week period during the second intensive round.

5.2 Radon Seasonal Trends (based on Weekly Measurements)

5.2.1 Indoor Air

Radon for indoor air was recorded on electrets from E-Perm in Fredrick, MD, or on Genitron Alphaguard units. The Alphaguard units were kept in stationary locations, one in the 422 second floor office and one in the 422 north basement. The electrets from all locations were read once per week on the same day, except during intensive rounds, when they were read once per day (only the weekly readings are included here; see **Figure 5-35**). The stationary Alphaguards were set to read continuously every 10 minutes and their data downloaded once per week (see **Figures 5-36** and **5-37**).

The electret readings are fairly stable over a 1-year period, beginning and ending at a similar concentration. The general pattern for high concentrations is ~10 pCi/L in the cooler months and ~5 pCi/L in the warmer months. The high for the winter months was 12.22 pCi/L at 422 basement south in week 8, and the low for the summer months was 0.15 pCi/L at 422 first in week 33 (see **Figure 5-35**).

The Alphaguard units were not brought online until the end of March 2011, so the electret figure and the Alphaguard figures cannot be aligned directly; the Alphaguard figures begin with week 13 on the electret figure (see **Figures 5-35** through **Figure 5-37**). Both Alphaguard figures show considerably more fluctuation than the electret figure because of their constant taking of readings. The Alphaguard figures also show a rough downward trend toward the warmer months and a rise toward the cooler months, with some fluctuation possibly due to weather changes (see **Figures 5-35** and **5-37**).

The intensive rounds, the main fan test period, and the period when the AC units were gone are marked on the figures (see **Figures 5-35** through **5-37**). The intensive rounds were included more to give an idea of the conditions taking place during each of the rounds rather than to suggest that intense sampling changed the normal patterns of readings.

On **Figure 5-35**, the general trend is to decrease toward the warmer months (weeks 20–36), but some areas do not fit the pattern. The AC units were installed on both sides of the duplex on June 29, 2011 (week 26). After this, readings hit a low in week 27. All ACs were stolen by July 15, 2011, and missing until replaced on the 422 side on August 3, 2011 (weeks 28 through 30). It is during this time when the ACs are missing that radon levels reached their highest for the summer months (**Figure 5-35**). A possible explanation for this is from the solar stack effect—the hot sun heats up the air in the higher stories of the house, producing an effect similar to what is achieved with the heater in winter. Something similar can be seen from weeks 23 through 26 just before the ACs were initially installed (see **Figure 5-35**). The readings start to rise and then fall sharply after the ACs were installed. Some other prominent points during the summer occur during the fan test period, when the basement was depressurized, increasing radon infiltration (see **Figure 5-35**).

Radon, in **Figures 5-36** and **5-37**, appears to reach much lower concentrations in warmer months than cooler ones; however, radon also appears to fluctuate less wildly in warmer months. Both figures show a reaction to the loss of the AC units, but the upstairs office Alphaguard shows a more immediate and definite response (see **Figures 5-36** and **5-37**). Both **Figures 5-36** and **5-37** show the effects of the fan tests on the stationary Alphaguard readings, but, again, the upstairs office Alphaguard shows a better defined response to the fan testing. The prominent peaks are not the same for both, suggesting fan tests had variable effects on different regions of the house (see **Figures 5-36** and **5-37**).

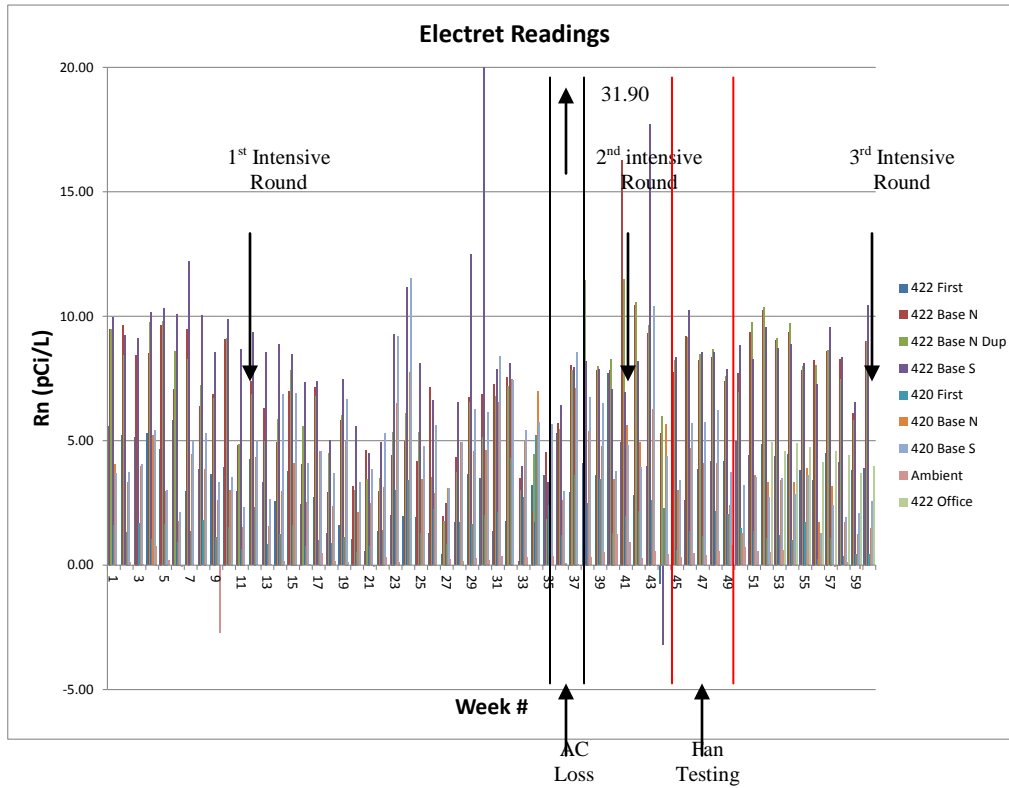

Figure 5-35. Weekly electret readings for all locations.

Arrows indicate intensive-round weeks. Black bars indicate the period when the ACs were missing. Red bars indicate the main fan test period. One reading extended beyond the current range of the figure. It reached 31.9 pCi/L and is indicated by the arrow and text. The original range was truncated to better view the data.

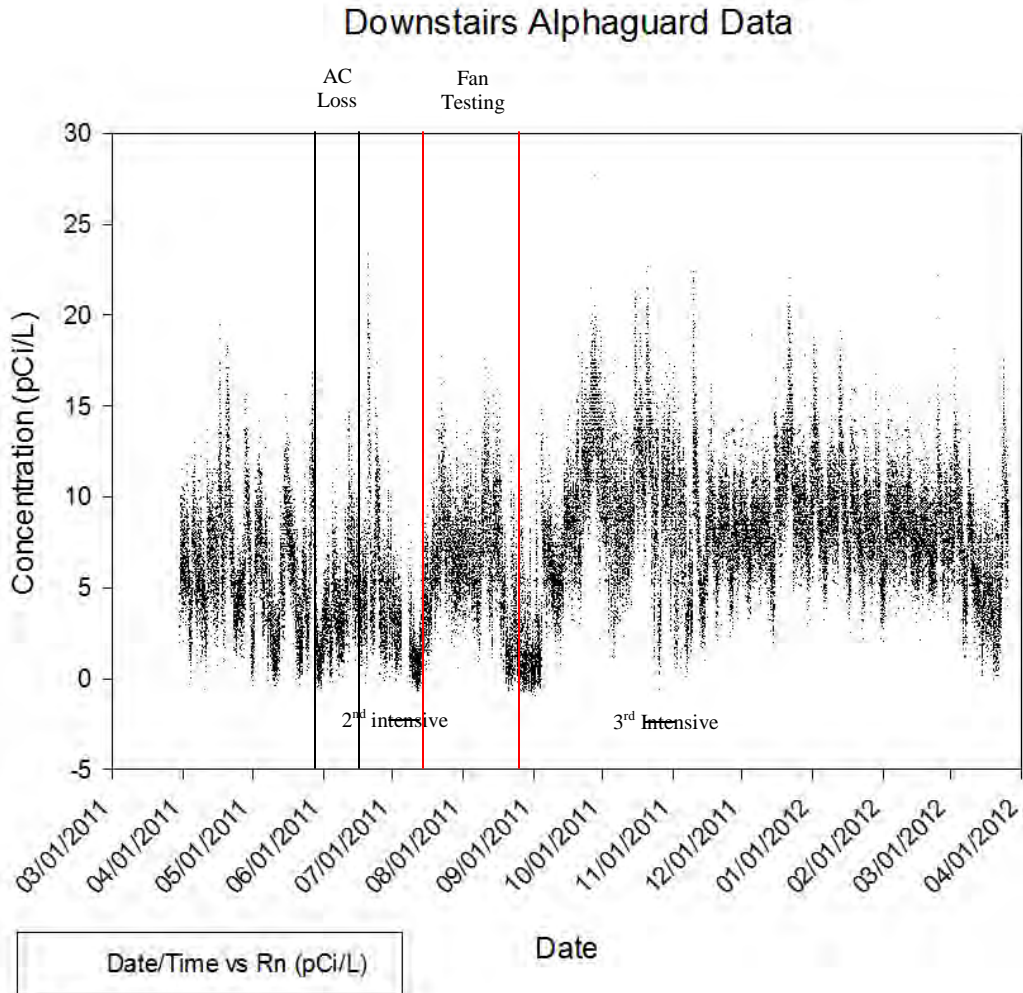

Figure 5-36. Data for the downstairs continuously recording Alphaguard versus time.

Data were recorded every 10 minutes. Note that readings did not begin until the end of March 2011. The two intensive rounds within this data range are indicated by horizontal bars. Black vertical bars mark the period of AC loss. Red bars indicate the fan test period.

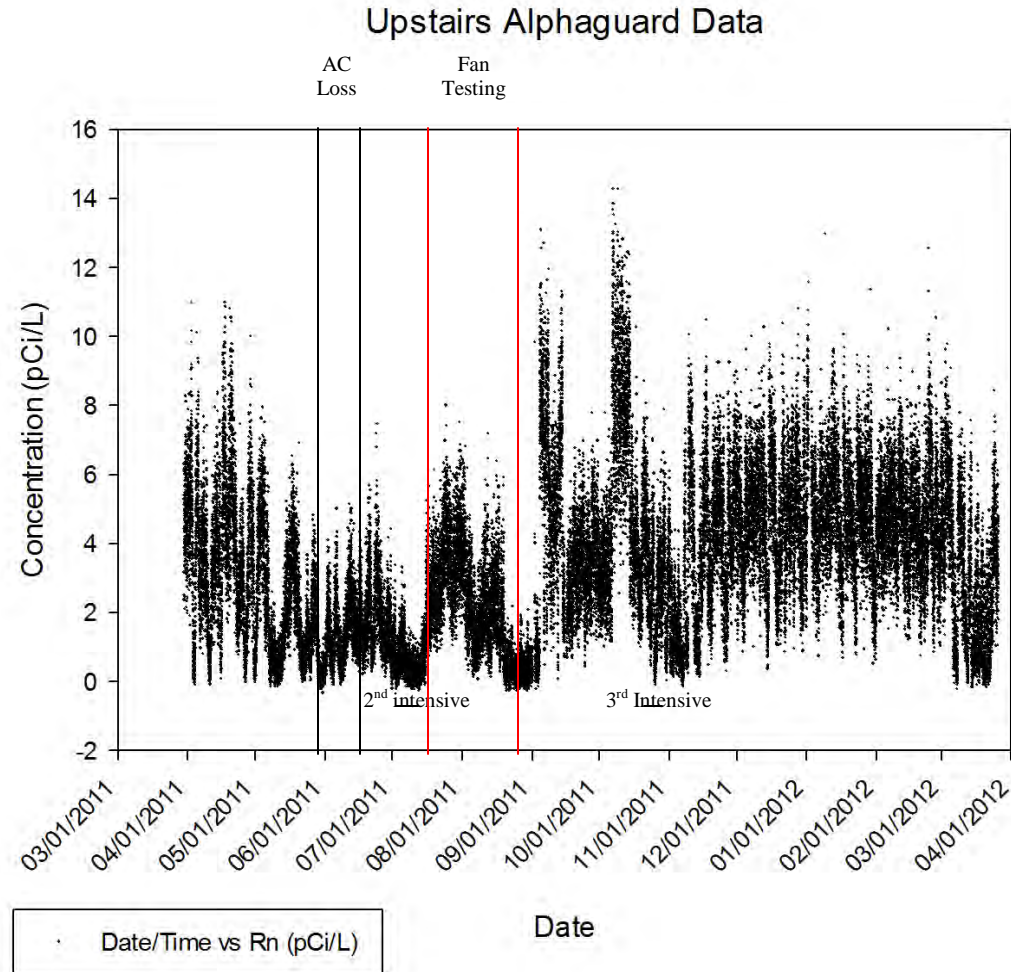

Figure 5-37. Data for the upstairs continuously recording Alphaguard versus time.

Data were recorded every 10 minutes. Note that readings did not begin until the end of March 2011. The two intensive rounds within this data range are indicated by horizontal bars. Black vertical bars mark the period of AC loss. Red bars indicate the fan test period.

5.2.2 Subslab and Wall Port Soil Gas

There were seven SSPs and four WPs at the 422/420 house. SSPs-1, -2, and -4, and WPs-1 through -3 were on the 422 side, and SSP-3, -5, -6, and -7, and WP-4 were on the 420 side. Radon readings at most ports were taken each week with a handheld Alphaguard unit.

Figure 5-38 shows radon concentrations as they were distributed around the 422/420 house (superimposed within the kriged image) during the first week of data collection. The general pattern is that radon is at its lowest concentration closer to the surface and increased to 1,000 pCi/L through 1,200 pCi/L at greater depths (see **Figure 5-38**). However, there is a zone of much higher concentrations from about 6 ft through 9 ft (see **Figure 5-38**). This zone of higher concentrations appears to be greater toward the southwest of the house (lower right of the figure).

Figures 5-39 and **5-40** show the radon concentration at SSPs and WPs for the duration of the project. The radon concentration for the SSPs in **Figure 5-39** is fairly stable among the ports with higher concentrations (at or above 1,000 pCi/L): SSP-1, SSP-4, SSP-5, and SSP-6). **Figure 5-39** shows that SSP-

4 and -6 have the highest concentrations. In contrast, **Figure 5-40** shows a more diffuse concentration pattern among all the WPs. Additionally, among WP-2 through -4, there appears to be a change in the distribution pattern that is higher in the autumn and lower at all other times (see **Figure 5-40**). As with the VOCs in Section 5.1.2., it is possible to see a vertical lines of measurements in **Figures 5-39** and **5-40** that correspond to the intensive sampling rounds conducted in early March, August, and December. These bars indicate a diurnal pattern of data variability only revealed by more frequent sampling, similar to what has been observed in other radon studies (see Section 2 for references)..

There is a rough agreement between the general pattern for SSPs and WPs and the kriged radon of **Figure 5-38**. The WPs tend to have fairly low concentrations compared with subslab concentrations, and the port of highest concentration is located in the southwest region of the house (see **Figures 5-38** through **5-40**). However, **Figure 5-38** shows the zone of higher concentrations as being deeper than just beneath the slab. Also, SSP-6 has fairly high concentrations, but that is in an area of the northwest section of the house, which should be low according to the kriged map (see **Figures 5-38** and **5-40**). As described in section 2, unlike chlorinated VOCs, radon has a short half life (3.8 days) and therefore its subsurface concentration is very influenced by the geologic materials immediately surrounding a sample point. Therefore these anomalies could simply represent small-scale heterogeneities in subsurface materials with respect to their radon generation potential.

3D View of Kriged Radon Data From Subslab, Wall and Multi-depth Soil Gas

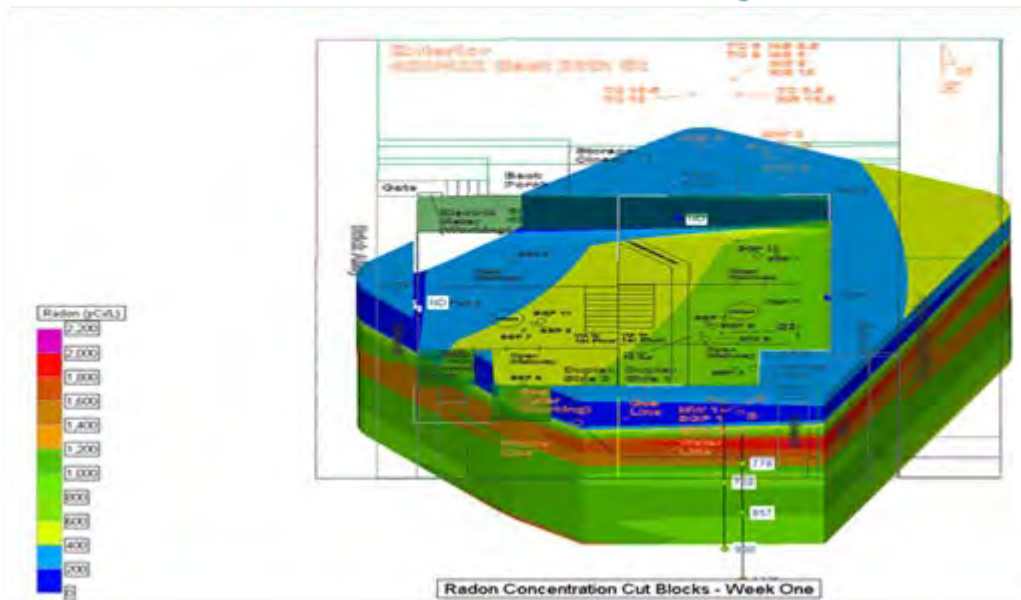

Figure 5-38. This is a kriged radon image taken from subslab, wall, and multidepth soil gas data.

To the left is a key showing the color code for different radon concentrations. The image follows that color code. On the image, a map of the 422/420 house is superimposed at depth. The bottom of the map faces south. Note that this is just the first week's data.

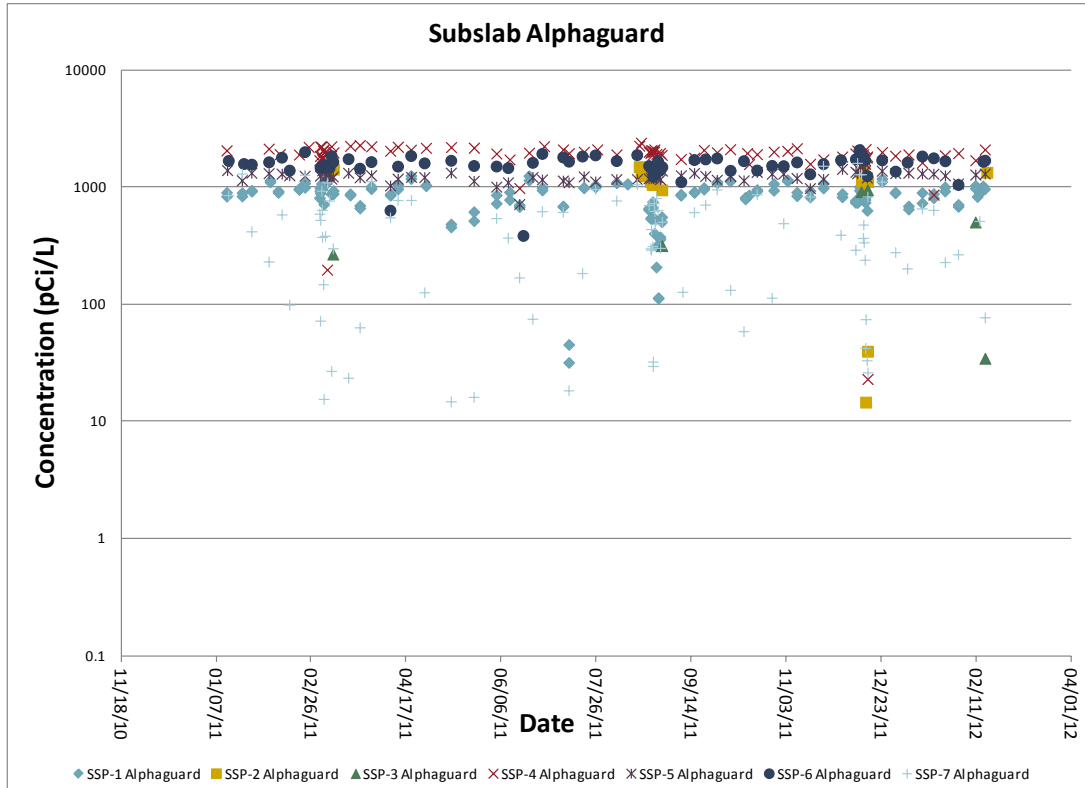

Figure 5-39. Subslab Alphaguard data versus time.

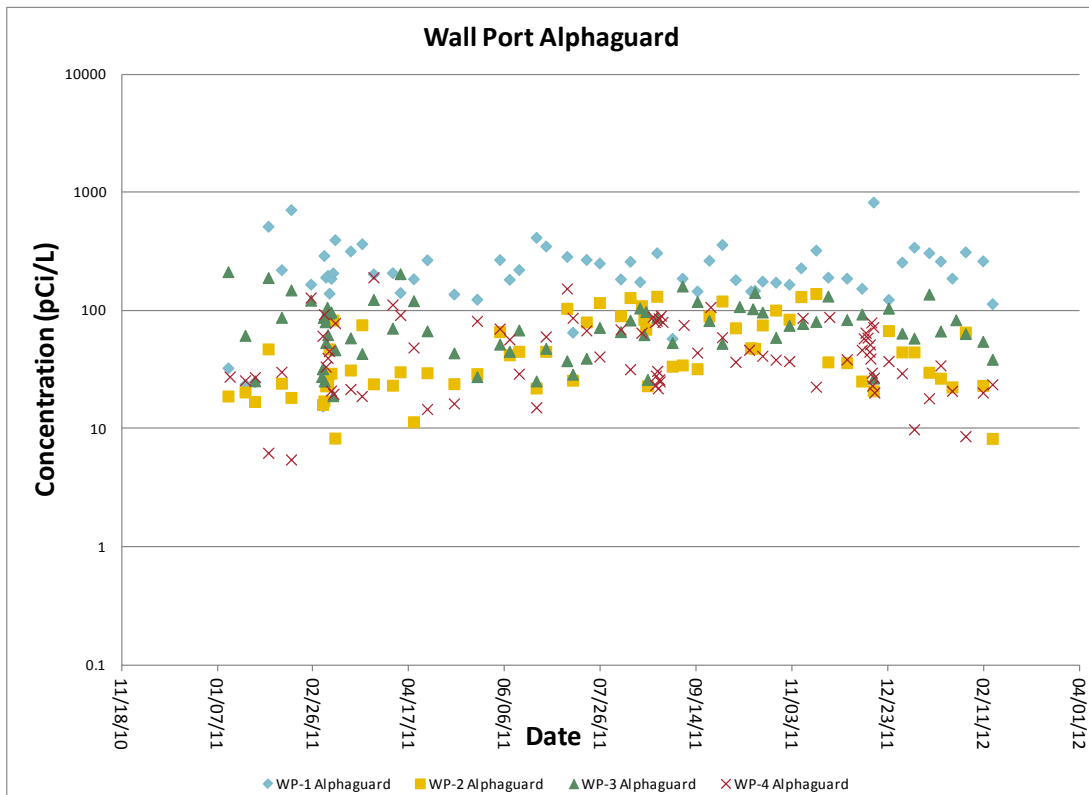

Figure 5-40. Wall port Alphaguard data versus time.

5.2.3 Deep Soil Gas

There were 12 nested SGPs at the 422/420 house. At each of the seven ports exterior to the house, there were five depths: 3.5 ft, 6 ft, 9 ft, 13 ft, and 16.5 ft. At the five interior ports, four of the five depths were used (6 ft, 9 ft, 13 ft, and 16.5 ft), the shallowest (3.5 ft) being eliminated because of the depth of the basement slab (~4 ft) beneath the ground surface. Radon data were taken each week with a Genitron Alphaguard. The sampling strategy each week was to obtain a reading at the shallowest two ports at each of the closest locations to the house exterior (SGP1-6 and -9; SGP4-9 and -13; SGP5-3.5 and -9; SGP7-3.5 and -9), the four WPs, the SSPs (SSP-1, -4, -5, -6, -7), and the shallowest ports at each of the basement SGPs (SGP8-6, SGP9-6, SGP10-6, SGP11-6, and SGP12-6).

Figure 5-41 is a kriged map of radon concentrations as they were distributed around the 422/420 house during the first week of data collection. As previously discussed, radon is at its lowest concentration closer to the surface and increased to about 1,000 pCi/L through 1,200 pCi/L at greater depths (see **Figure 5-41**). However, there is a zone of much higher concentrations from about 6 ft to 9 ft (see **Figure 5-41**) toward the southwest of the house (lower right of the figure).

Figures 5-42 through **5-45** present the data from the ports external to the house, and **Figures 5-46** through **5-50** are internal to the house. Most are generally stable throughout the duration of the project, with little fluctuations. However, **Figures 5-44** and **5-45** (SGP5 and 7) show what might be seasonal (winter) lows for the 3.5-ft ports.

The data from **Figures 5-42** through **5-50** agree fairly well with the kriged distribution of radon shown in **Figure 5-41**. The locations with some of the highest concentrations are found toward the southwest of the house (SGP1-6 and SGP9-6; **Figure 5-42** and **5-47**). However, SGP7-9 also has some higher concentrations (**Figure 5-45**), which would not be expected from looking at the radon distribution mapped in **Figure 5-41**.

The deeper ports at the soil gas locations were taken less frequently. As a result, only general characteristics of the deeper soil gas activity can be inferred. Deeper soil gas was stable for the duration of the project, except the 13-ft interval decreased over time at SGP1 (see **Figure 5-42**), and the 13-ft interval increased over time at SGP5 and 9 (see **Figures 5-44** and **5-47**).

3D View of Kriged Radon Data From Subslab, Wall and Multi-depth Soil Gas

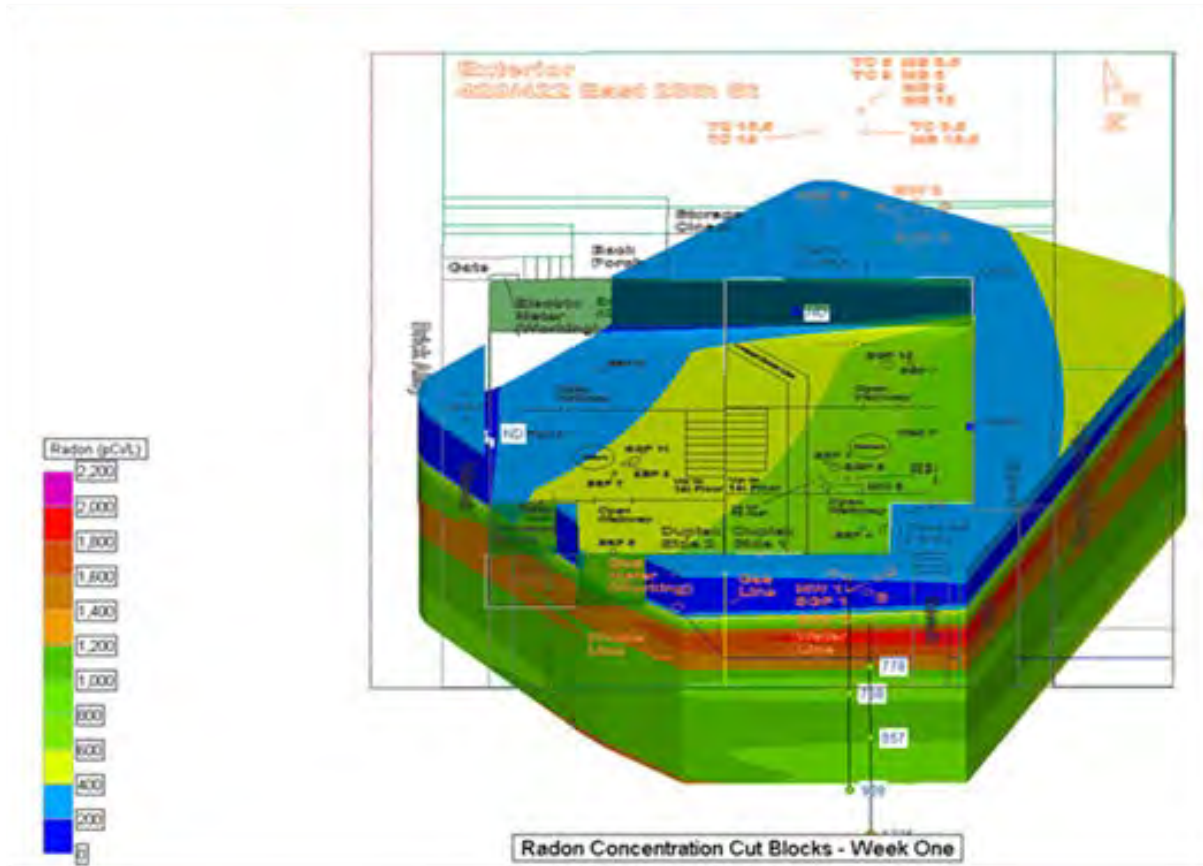

Figure 5-41. Kriged radon image taken from subslab, wall, and multidepth soil gas data.

To the left is a key showing the color code for different radon concentrations. The image follows that color code. On the image, a map of the 422/420 house is superimposed at depth. The bottom of the map faces south. Note that this is just the first week's data.

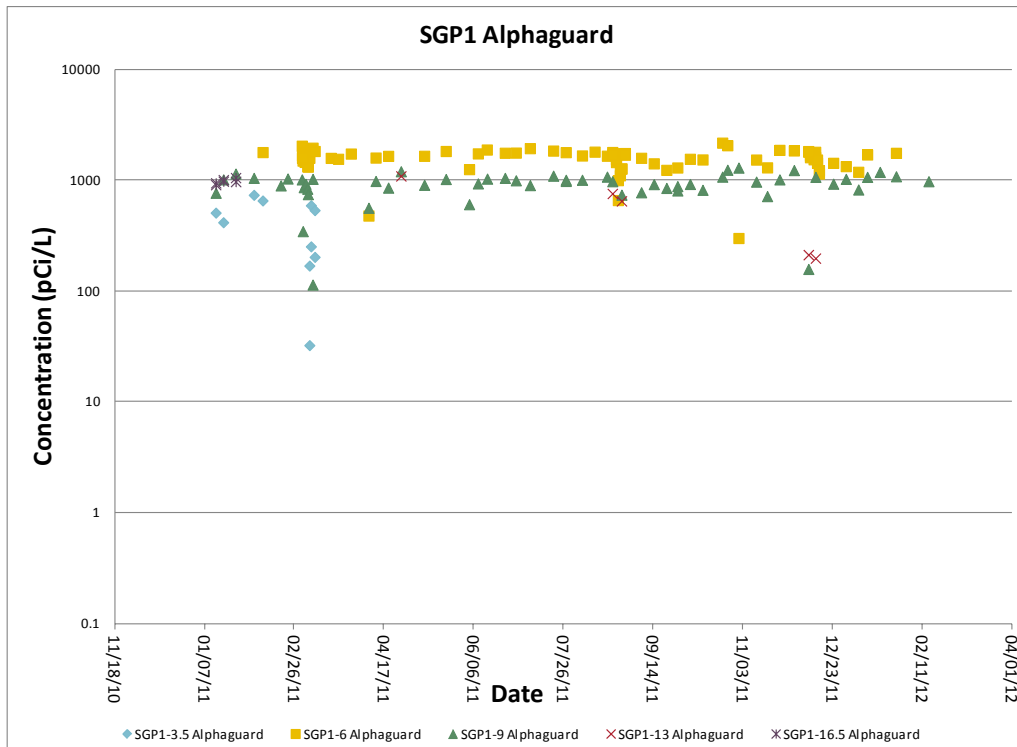

Figure 5-42. Handheld Alphaguard data taken from soil gas ports at location 1 versus time.

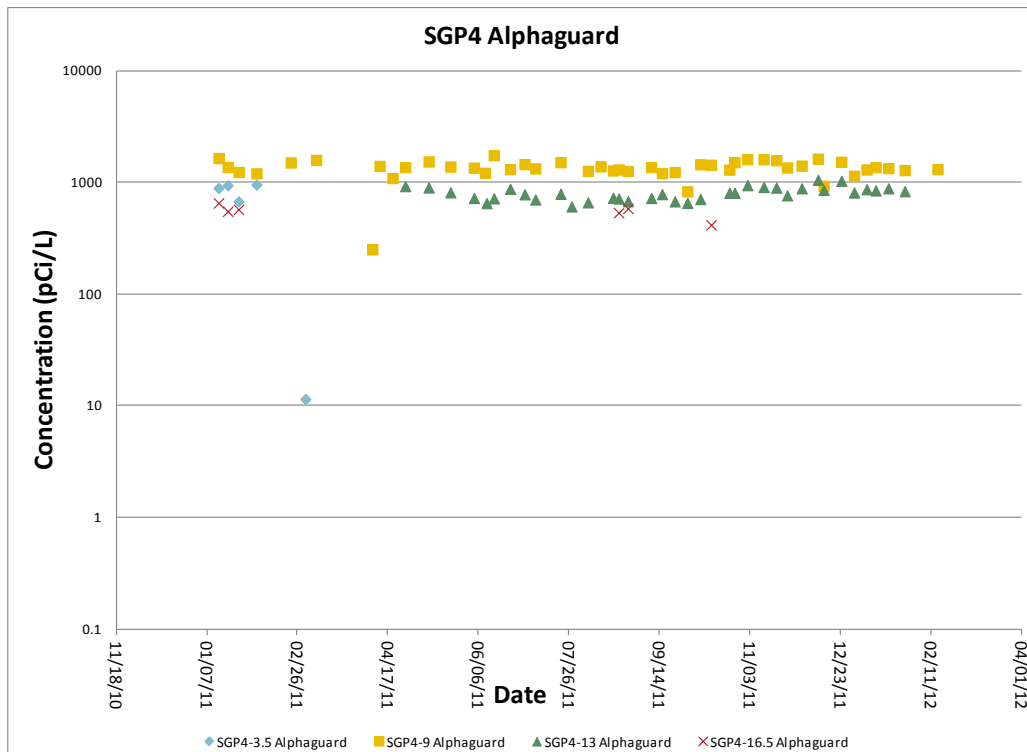

Figure 5-43. Handheld Alphaguard data taken from soil gas ports at location 4 versus time.

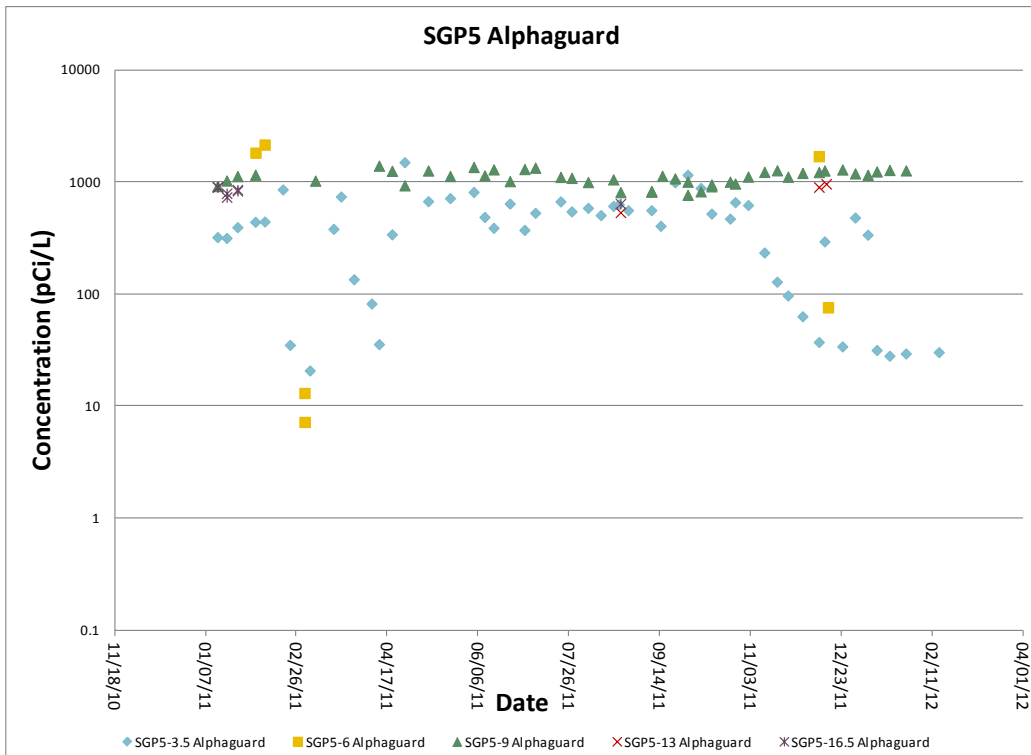

Figure 5-44. Handheld Alphaguard data taken from soil gas ports at location 5 versus time.

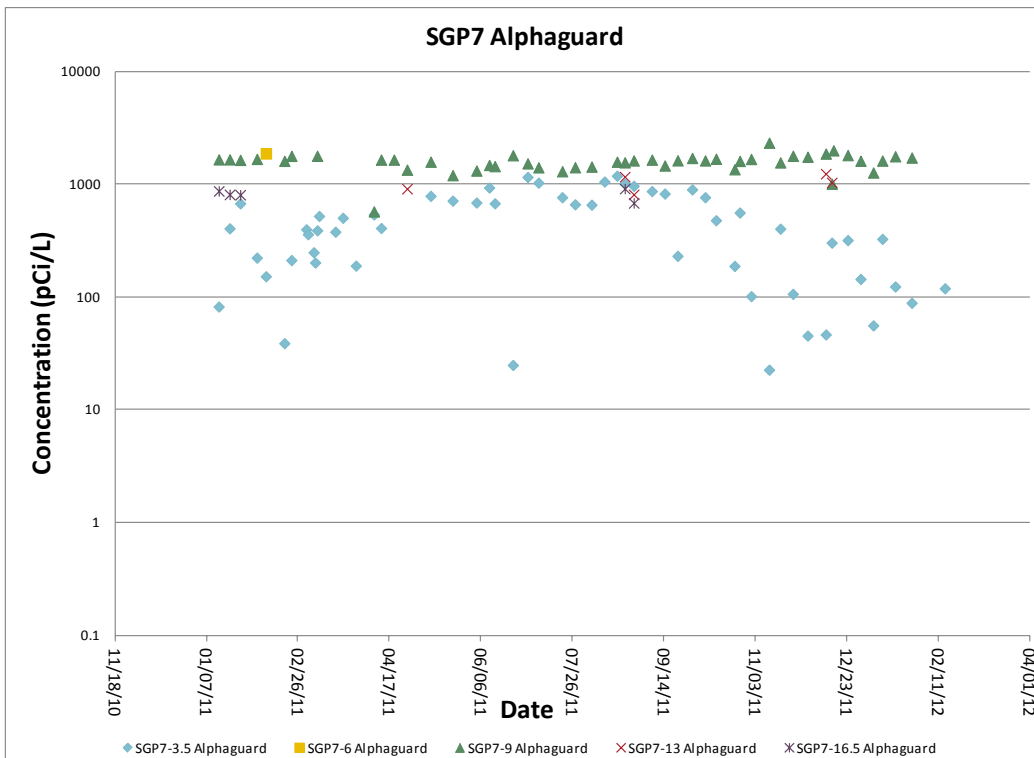

Figure 5-45. Handheld Alphaguard data taken from soil gas ports at location 7 versus time.

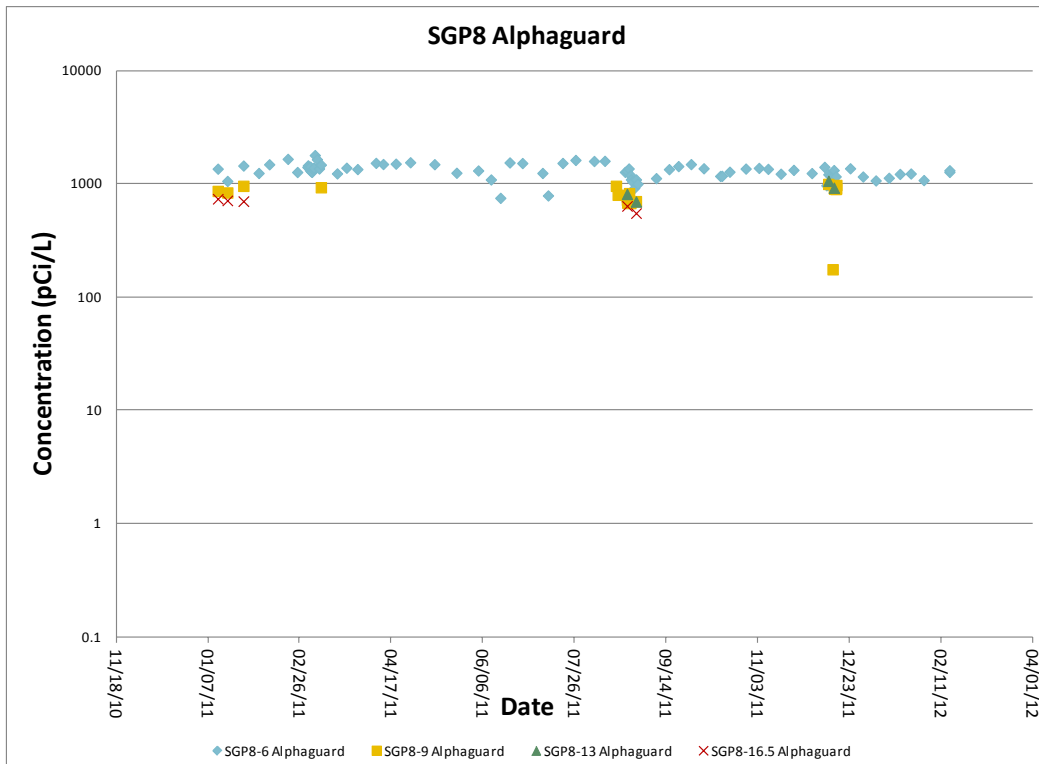

Figure 5-46. Handheld Alphaguard data taken from soil gas ports at location 8 versus time.

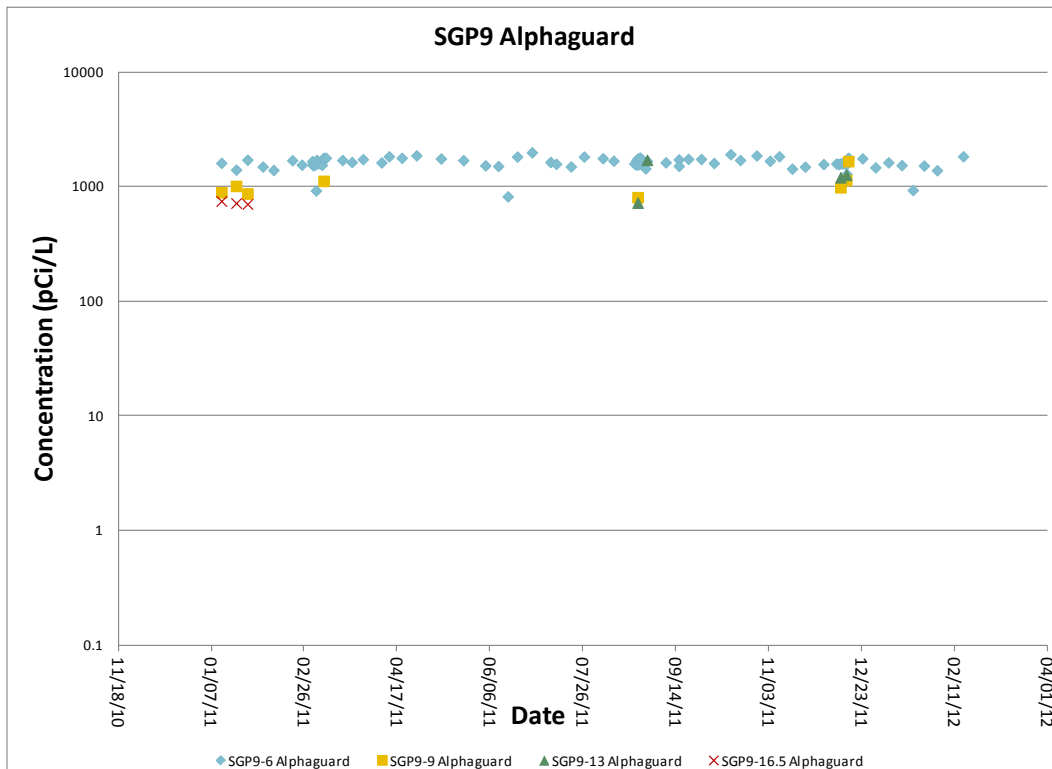

Figure 5-47. Handheld Alphaguard data taken from soil gas ports at location 9 versus time.

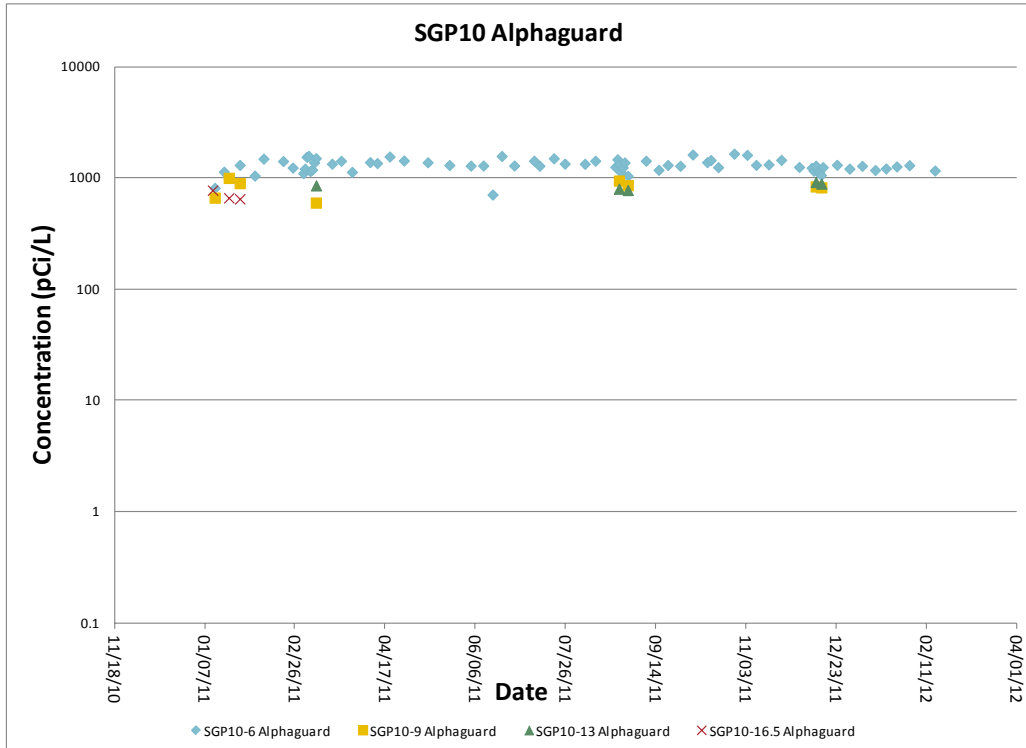

Figure 5-48. Handheld Alphaguard data taken from soil gas ports at location 10 versus time.

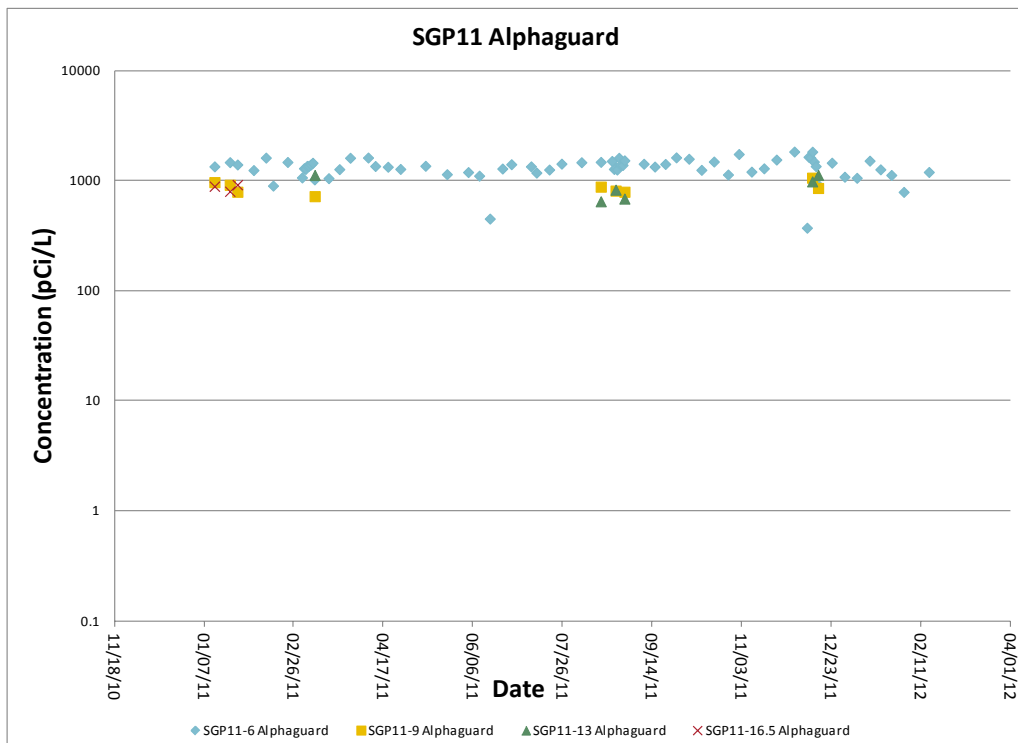

Figure 5-49. Handheld Alphaguard data taken from soil gas ports at location 11 versus time.

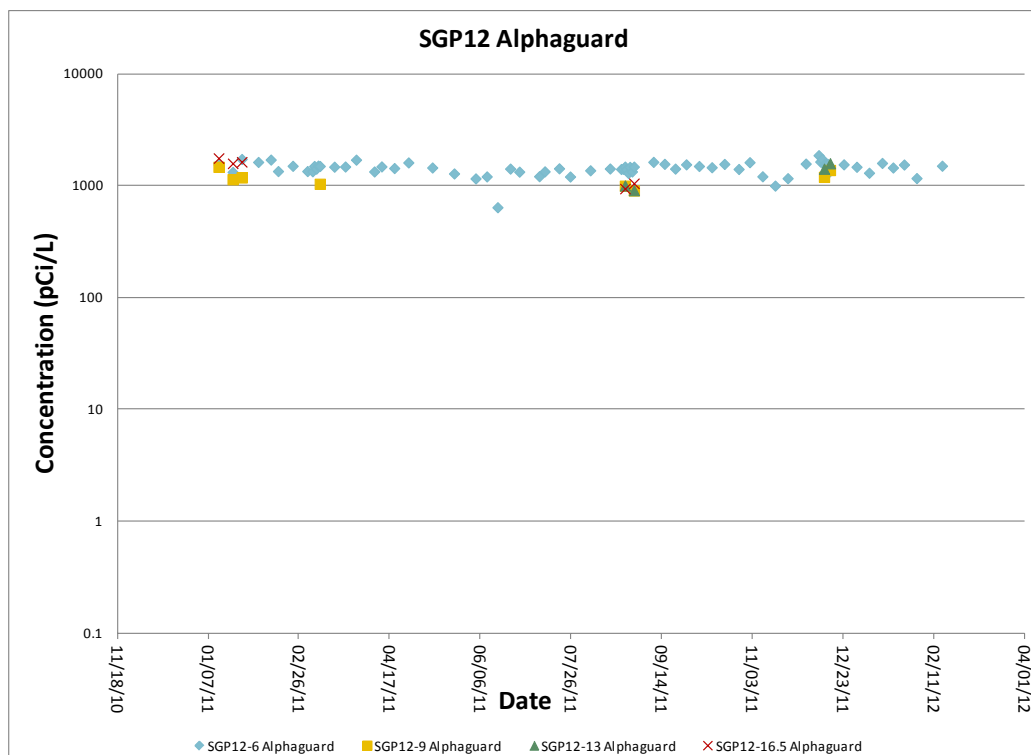

Figure 5-50. Handheld Alphaguard data taken from soil gas ports at location 12 versus time.

5.3 VOC Short-Term Variability (Based on Daily and Hourly VOC Sampling)

Online GC data were used to assess short term variability in indoor air and selected SGPs. As described in Section 3. The online GC was used to measure VOC vapors from a variety of sampling points, including indoor and ambient air and wall port, subslab, and deeper soil gas monitoring ports. The online GC was conducted in 2 phases: from August to late-October and from late November to mid-February. When interpreting the magnitude of variability during the first phase of GC operation the use of a ventilation fan during parts of the earlier phase should be taken into account (see Section 12.3).

5.3.1 Indoor air

5.3.1.1 Chloroform

Measured values for the 422 first floor ranged from detection level ($\sim 0.1 \mu\text{g}/\text{m}^3$) to $\sim 1.0 \mu\text{g}/\text{m}^3$. There was a notable increase in values by approximately a factor of 4 to 5 starting in September and values remained at that level until the end of the program in February (**Figure 5-51**). Temporal variations were less than a factor of 2.

Measured values for the 422 basement were generally slightly higher than on the first floor, ranging from detection level ($\sim 0.1 \mu\text{g}/\text{m}^3$) to $\sim 1.7 \mu\text{g}/\text{m}^3$. Similar to the first floor, there was a notable increase in values by approximately a factor of 5 starting in September, and values remained at that level until the end of the program in February (**Figure 5-52**). Short-term temporal variations were less than a factor of 3.

Measured values for the 420 first floor (the non-heated side of the duplex) ranged from detection level ($\sim 0.1 \mu\text{g}/\text{m}^3$) to $\sim 1.0 \mu\text{g}/\text{m}^3$. Values were about the same as measured in the 422 first floor for the first

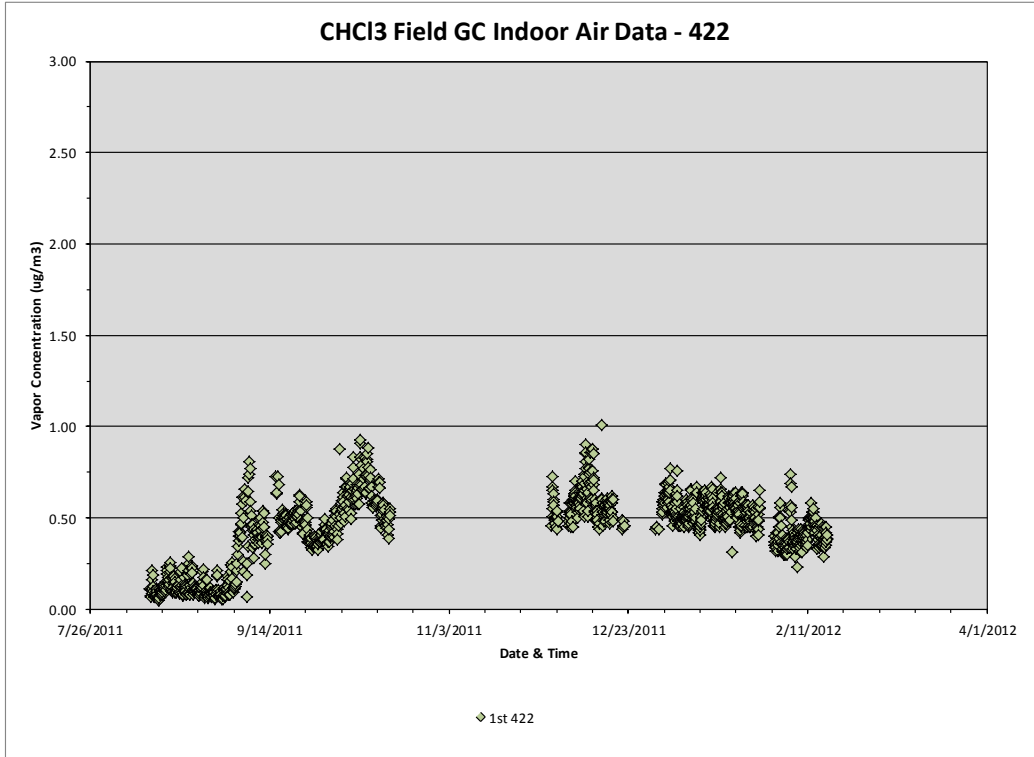

Figure 5-51. Online GC chloroform indoor air data for 422 first floor.

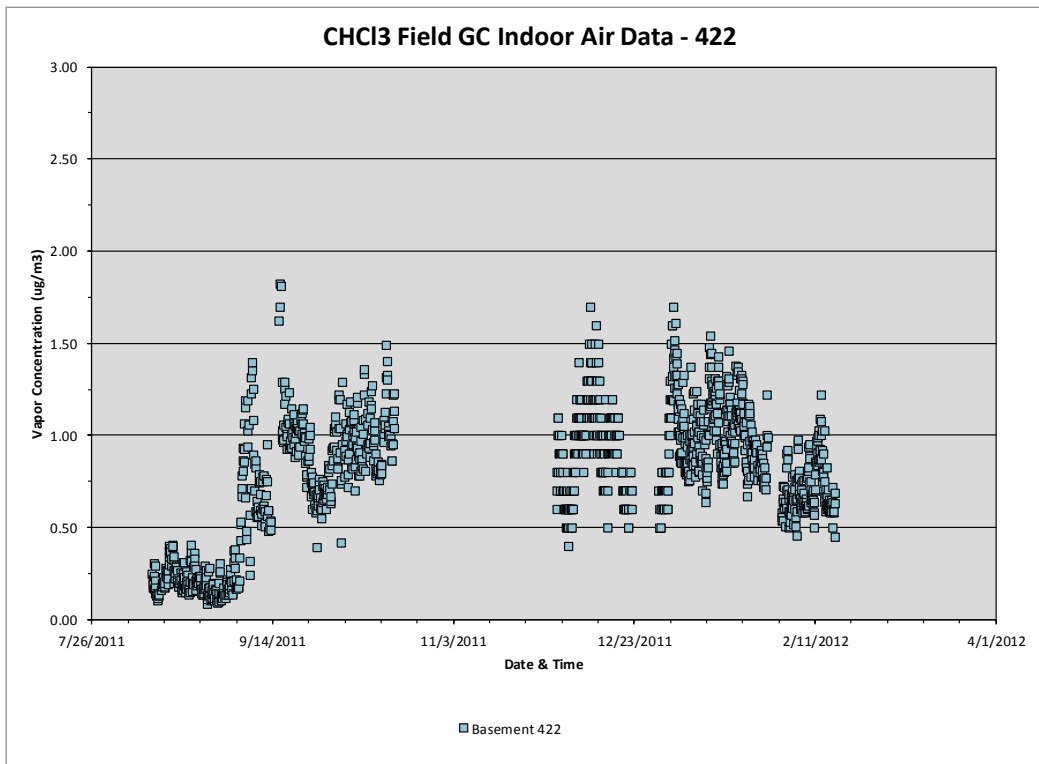

Figure 5-52. Online GC chloroform indoor air data for 422 basement.

phase, but slightly lower than on the 422 side during the second phase and showed less scatter. Similar to the 422 side, there was an increase in values starting in September and continuing into October (**Figure 5-53**). Other than these step changes, short-term temporal variations were generally less than a factor of 2.

Measured values for the 420 basement ranged from $\sim 0.3 \mu\text{g}/\text{m}^3$ to $\sim 1.0 \mu\text{g}/\text{m}^3$ (**Figure 5-54**). A less distinct step change is seen at this port in late September. Aside from that step change, short-term temporal variations were generally less than a factor of two. Values were slightly lower than values measured in the 422 basement especially during the second phase.

5.3.1.2 Tetrachloroethylene (PCE)

Measured values for the 422 first floor ranged from $0.2 \mu\text{g}/\text{m}^3$ to $\sim 2.2 \mu\text{g}/\text{m}^3$, although the vast majority of values ranged from $0.5 \mu\text{g}/\text{m}^3$ to $1.0 \mu\text{g}/\text{m}^3$ (**Figure 5-55**). Generally, the levels were similar for both sampling phases, although there were periods of higher values in the second (winter) phase. Temporal variation during the first phase was generally less than a factor of two, but short-term temporal variations in the second phase were up to a factor of four. Measured values for the 422 basement ranged from $\sim 0.3 \mu\text{g}/\text{m}^3$ to $\sim 3.2 \mu\text{g}/\text{m}^3$. Temporal variations were less than a factor of two during the first (summer-fall) phase, but short-term temporal variations in the second (winter) phase were up to a factor of four, similar to the variations seen on the first floor (**Figure 5-56**). This could be related to cooler temperatures or greater temperature swings during the colder months.

Measured values for the 420 first floor (the non-heated part of the house) ranged from detection level ($\sim 0.1 \mu\text{g}/\text{m}^3$) to $\sim 2.2 \mu\text{g}/\text{m}^3$ (**Figure 5-57**). Generally the values were higher with little temporal variation in the summer-fall phase and lower with much greater short-term variation during the winter phase. Temporal variation during the first phase was generally less than a factor of two, but short-term temporal variations in the second phase were up to a factor of 10. Similarly, measured values for 420 basement ranged from detection level ($\sim 0.1 \mu\text{g}/\text{m}^3$) to $\sim 2.2 \mu\text{g}/\text{m}^3$, with similar patterns to those seen on the first floor: little temporal variation during the summer-fall ($<2x$) and higher short-term variations during the winter phase of a factor of 10 (**Figure 5-58**). Although this is the same general pattern observed for the 422 heated side, the unheated nature of the 420 side of the building seems to have intensified the effect.

5.3.1.3 Comparison Between the Two Sampling Phases

Chloroform

The concentrations measured in both the basement and on the first floor of both units remained relatively consistent over both sampling phases from August 2011 to February 2012. The computed percent standard deviation (%RSD) for each floor was as follows:

422 first floor:	22%
422 basement	17%
420 first floor:	30%
420 basement	10%

The lack of a change in concentrations in the 422 side of the duplex is surprising because of the large increase in subslab concentrations observed under this unit as described in Section 5.3.2.

Tetrachloroethylene

The concentrations measured on the basement and first floor of unit 422 remained relatively consistent across both sampling phases, from August 2011 to February 2012.

422 first floor:	12%
422 basement	26%

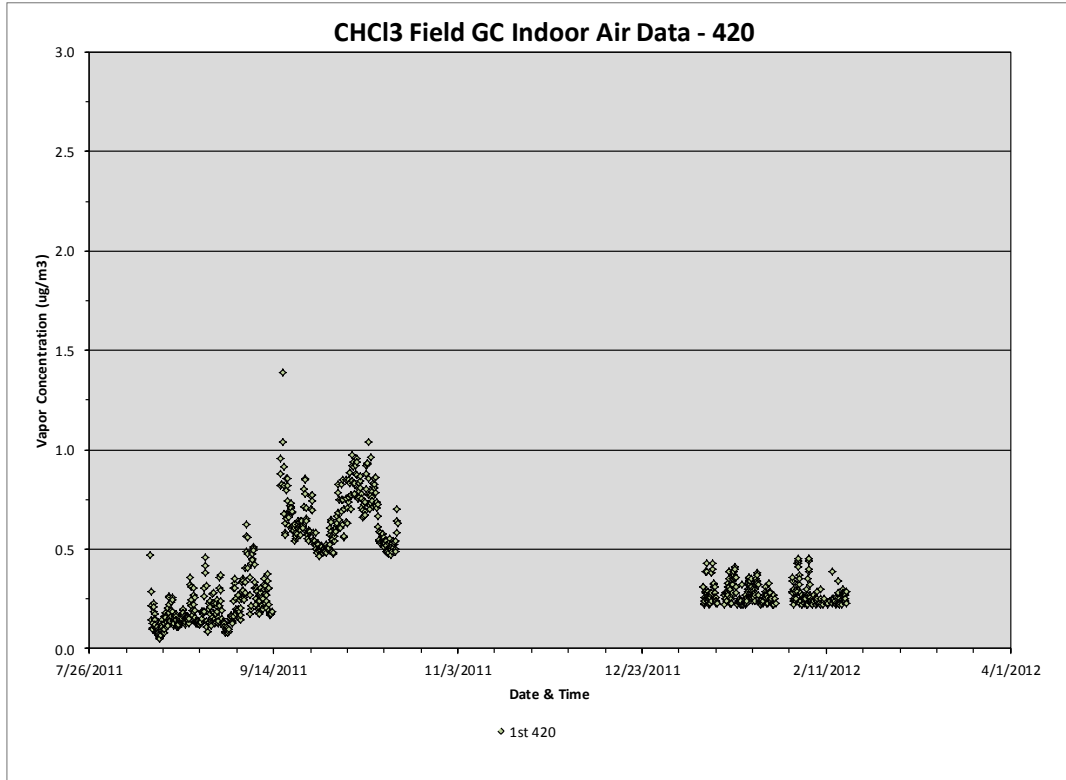

Figure 5-53. Online GC chloroform indoor air data for 420 first floor.

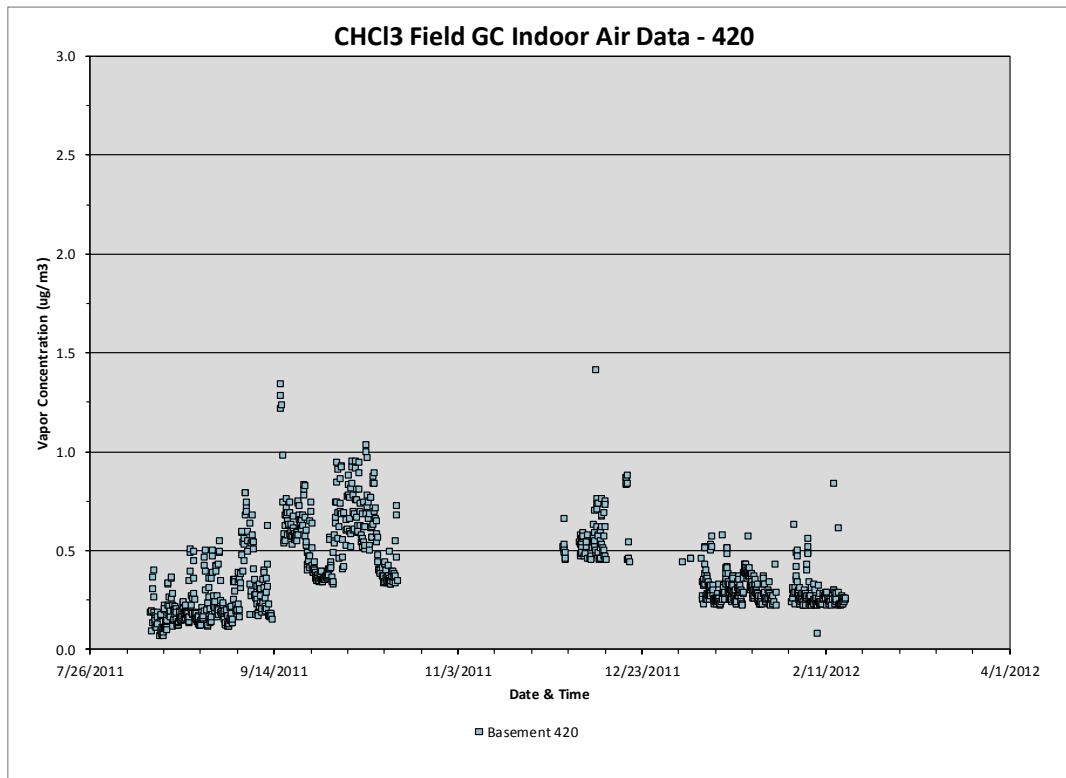

Figure 5-54. Online GC chloroform indoor air data for 420 basement.

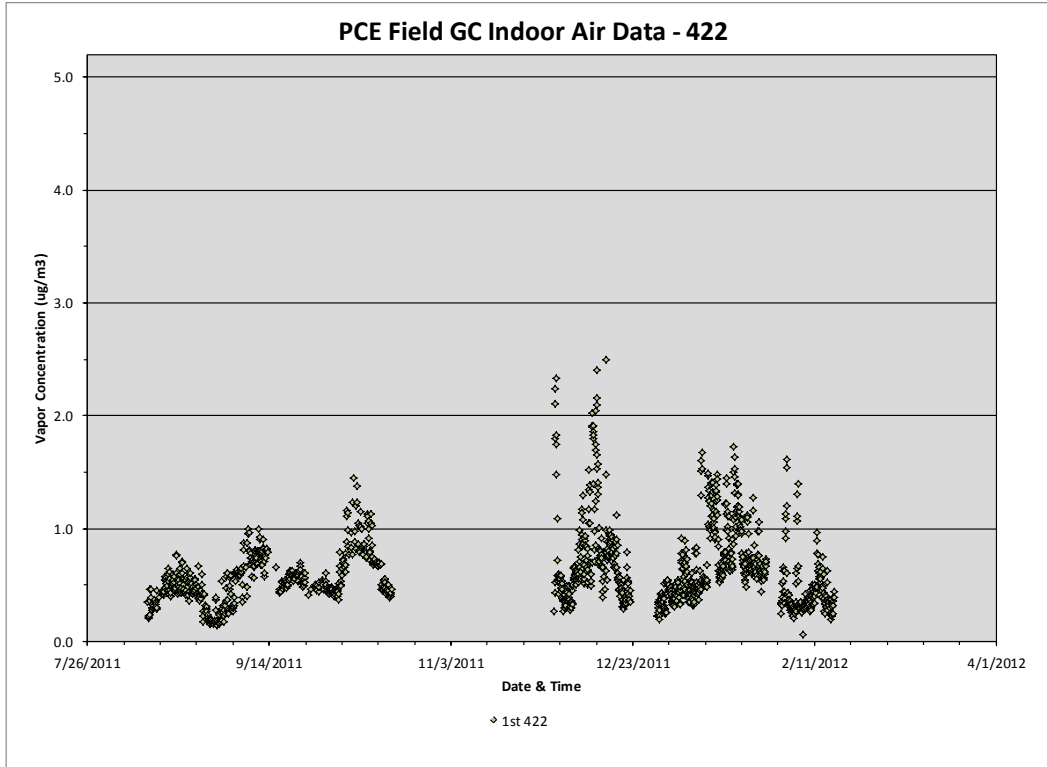

Figure 5-55. Online GC PCE indoor air data for 422 first floor.

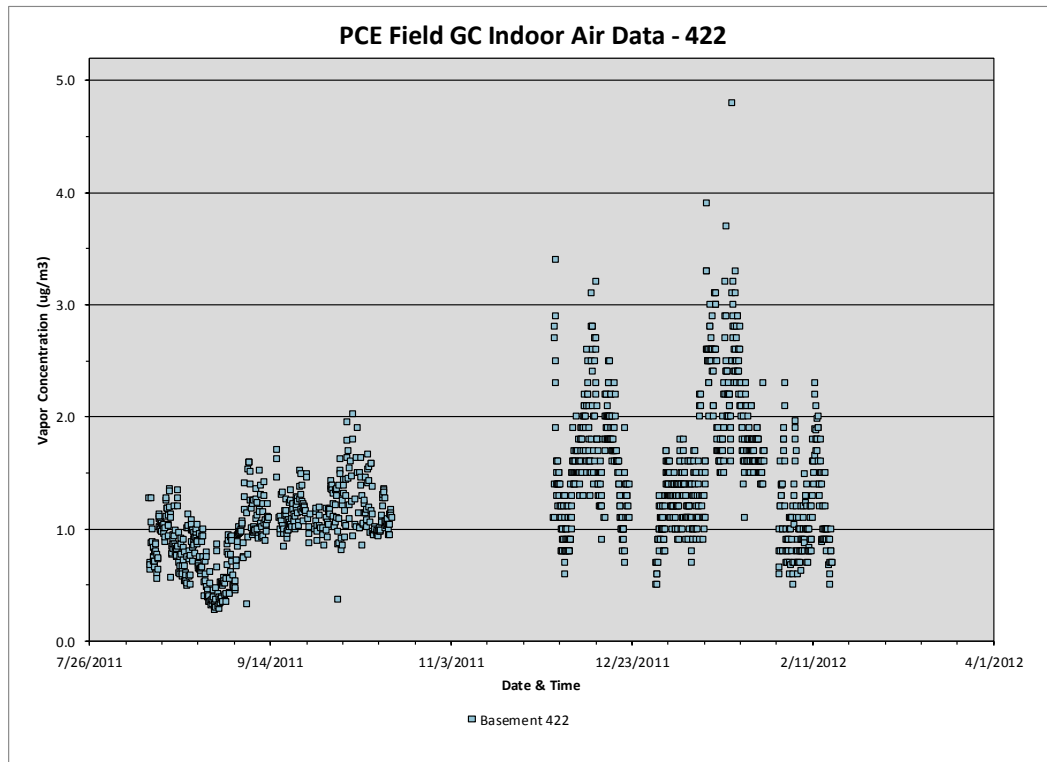

Figure 5-56. Online GC PCE indoor air data for 422 basement.

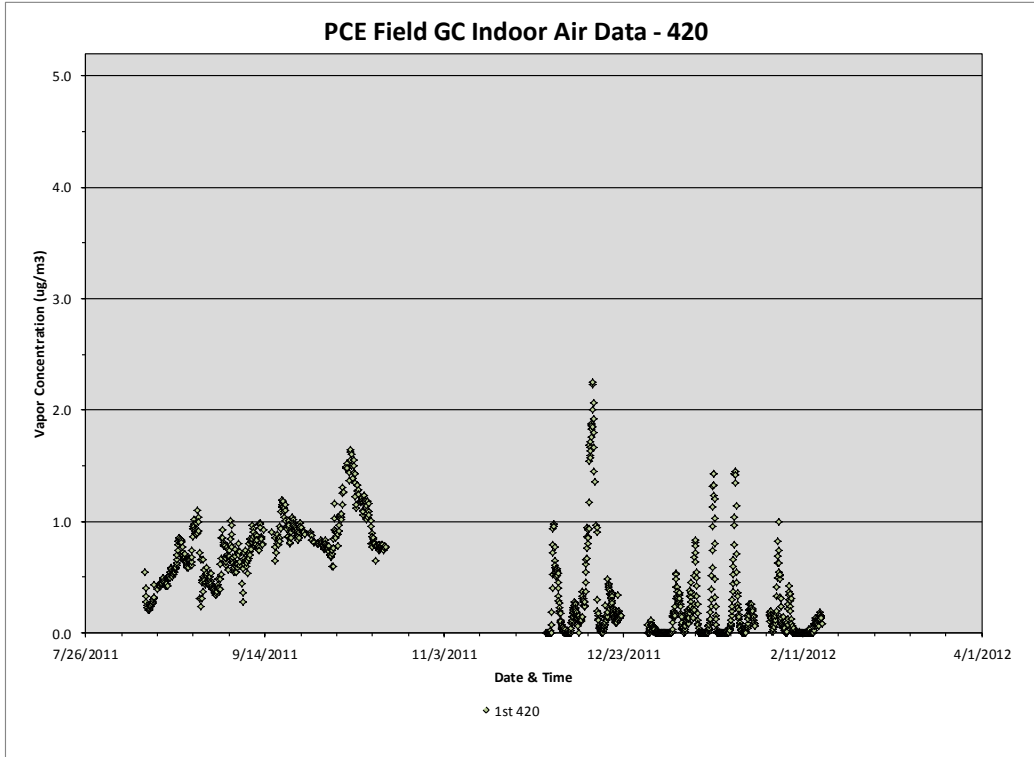

Figure 5-57. Online GC PCE indoor air data for 420 first floor.

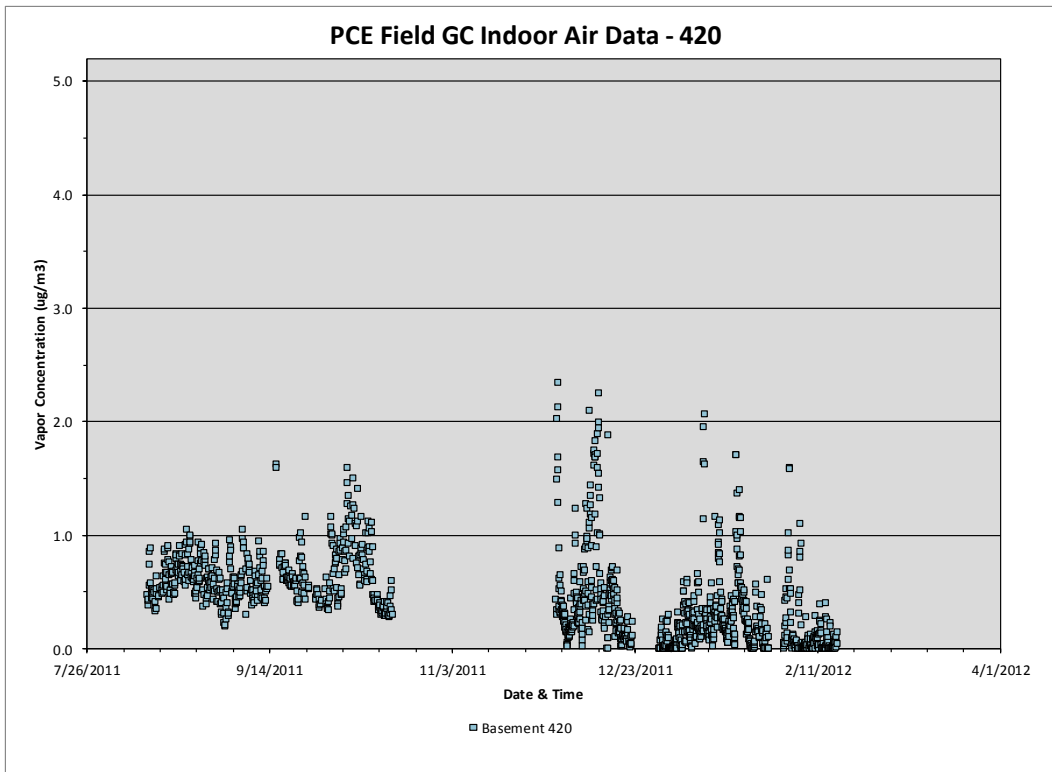

Figure 5-58. Online GC PCE indoor air data for 420 basement.

However, greater variation was observed on both floors of the unheated 420 unit:

420 first floor:	88%
420 basement	50%

The larger variations are due to the short-term temporal variations of up to a factor of 10, as shown in **Figures 5-57** and **5-58**. As previously discussed this may be due to greater temperature swings in the unheated part of the house.

5.3.2 Subsurface Soil Gas Data

Subsurface concentrations were monitored at eight locations with the automated GC:

- three subslab locations: SSP-2, SSP-4, and SSP-7
- four soil gas locations: SGP2-9 ft, SGP8-9 ft, SGP9-6 ft and SGP11-13 ft
- one location in the wall on the side of the basement (WP-3).

Approximately 600 measurements per location were collected in Phase 1 and approximately 900 measurements per location were collected in Phase 2 at each of these eight locations.

5.3.2.1 Chloroform

The chloroform data from the automated GC for all locations for both sampling phases are summarized in **Figure 5-59** and for the separate phases in **Figures 5-60** and **5-61**.

In the first phase of the program, chloroform values were relatively constant until approximately September 13. At that time, the instrument inexplicably stopped and was not restarted until 2 days later on September 15. Upon restart, there is an abrupt increase in all the chloroform values but not the tetrachloroethylene values. This shift occurred because of a change in the chloroform baseline definition by the integration software and was not due to changes in the actual chloroform concentrations.

The following behaviors were observed in the first phase (**Figure 5-60**):

- Temporal variation is generally less than a factor of 2 at all the sample locations during this phase except for location WP-3.
- At probe WP-3, the concentrations show repeated high and low variations of a factor of 3 to 5 times occurring over time scales of several days. WP-3 was the only location to exhibit this behavior.

In the second phase of the program (**Figure 5-61**), the following behaviors were observed:

- Probe WP-3 continued showing the same oscillations as in the first phase.
- Probes SGP9-6 ft and SSP-4 showed a continual rise in concentrations throughout the sampling period, increasing by approximately 2 to 2.5 times above the starting concentration of the second phase. This same increase at SGP9-6 ft was also observable in the extractive samples (method TO-17 data set) as a trend running from late August to December. This pattern was not seen in the first phase of the program. Despite the large concentration increase of chloroform during this second phase, there was no concurrent increase in the indoor air concentrations of chloroform measured by the online GC in either the basement or first floor of unit 422.
- Chloroform variations in all the other subsurface probes were less than 50%.

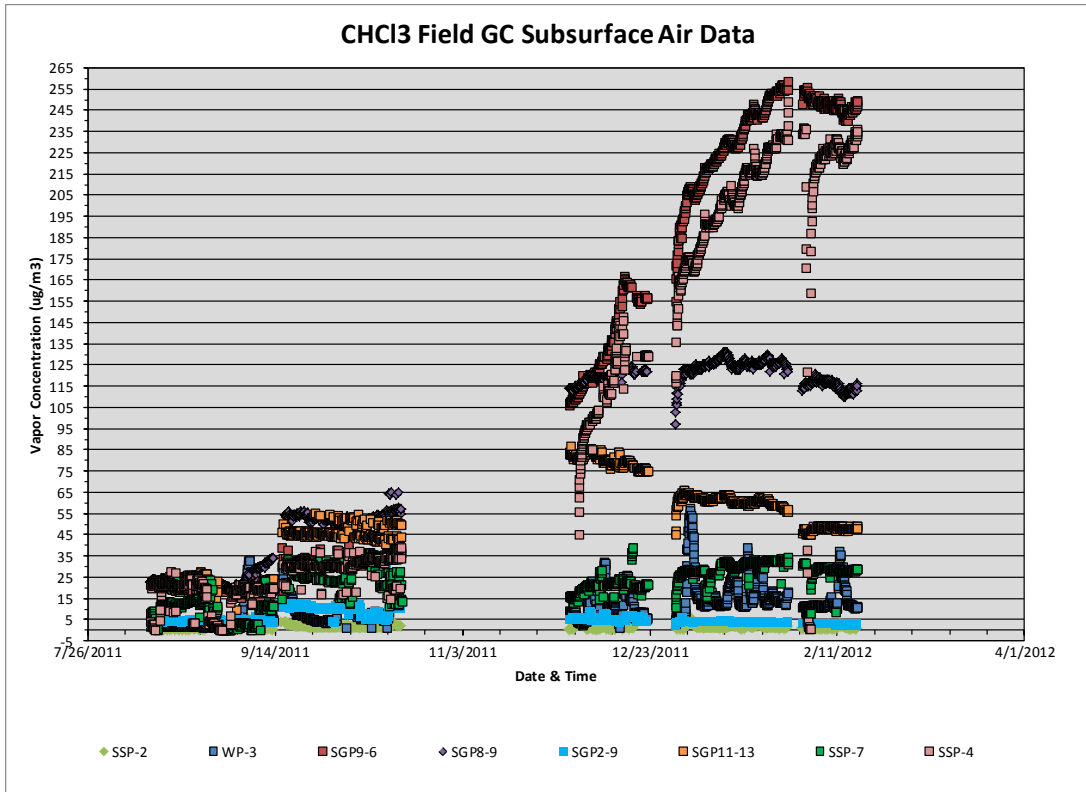

Figure 5-59. Online GC subsurface chloroform soil gas data—Phase 1 and Phase 2.

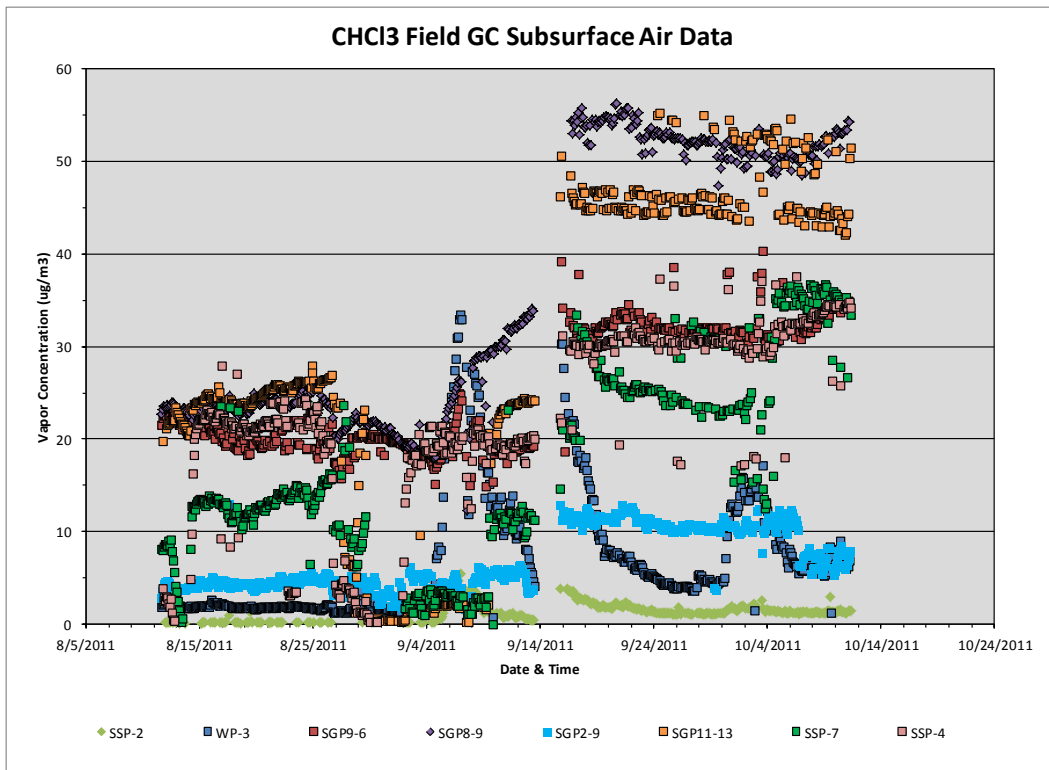

Figure 5-60. Online GC subsurface chloroform soil gas data—Phase 1.

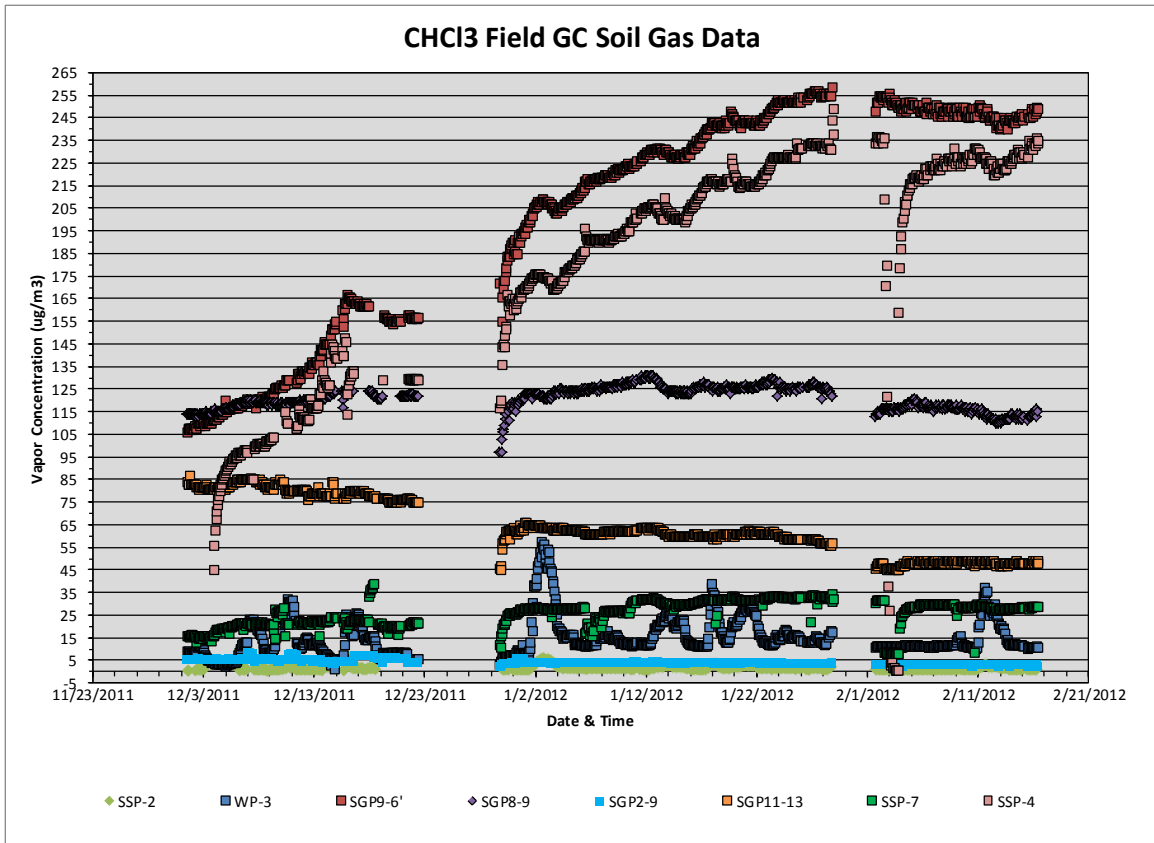

Figure 5-61. Online GC subsurface chloroform soil gas data—Phase 2.

5.3.2.2 Tetrachloroethylene (PCE)

The tetrachloroethylene data from the automated GC for all locations for both sampling phases are summarized in **Figure 5-62** and for the separate phases in **Figures 5-63** and **5-64**.

In the first phase of the program (**Figure 5-63**), it appears as if there is a lot of fluctuation in the subsurface values. However, inspection of the individual locations shows the following:

- Probes SGP2-9 ft, SGP8-9 ft, and SGP9-6 ft show only slight temporal variations of 20% to 50% over the sampling period.
- There are two probes that field records suggest may have been inadvertently closed for a period of time:
 - SGP11-13 ft 8/29/11 @ 15:16 closed; 9/9/11 between 14:00 and 15:00 opened
 - SSP-7 ft 8/29/11 @ 15:36 closed; 9/9/11 between 14:00 and 15:00 opened

If those periods of inadvertent closure are discounted, then variation during this phase was less than a factor of 3 at these two ports.

- Probes SSP-4 and SSP-2 also show less than a factor of 2 temporal variation over most of the sampling period. However, both of these probes contain a group of analyses when the values dropped rapidly by large amounts and then increased rapidly back to the prior values (**Figure 5-61**). The cause for this behavior is not clear. The drop in SSP-2 data occurred at times

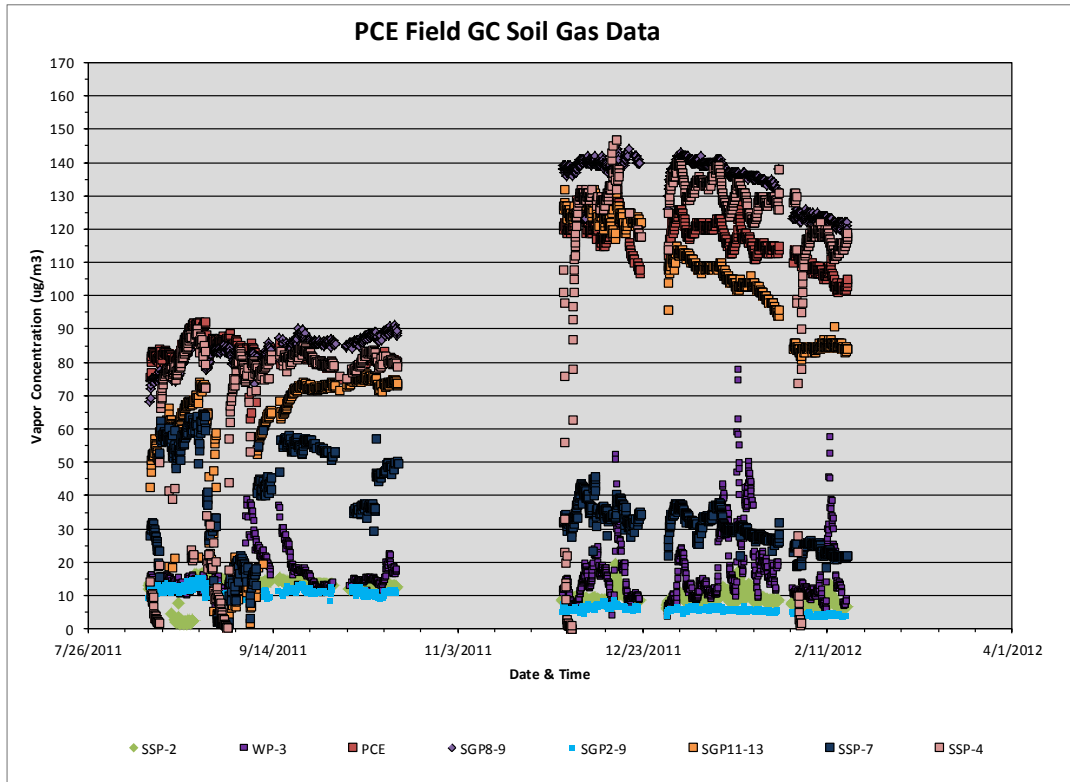

Figure 5-62. Online GC subsurface PCE soil gas data—Phase 1 and Phase 2.

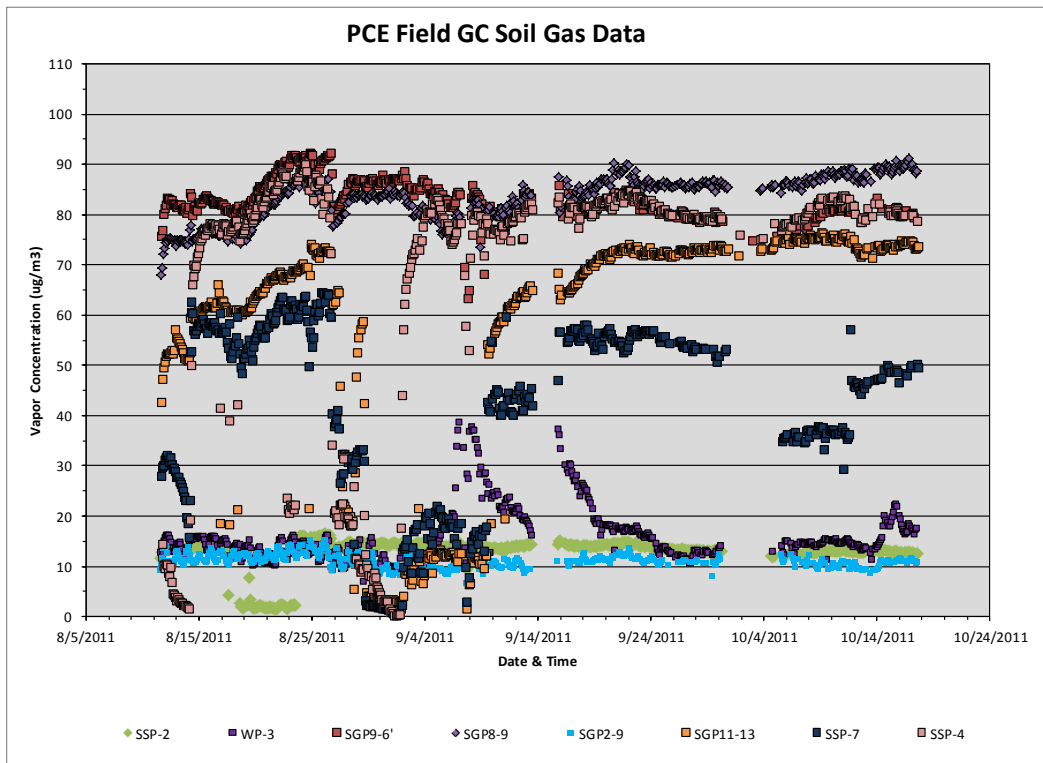

Figure 5-63. Online GC subsurface PCE soil gas data—Phase 1.

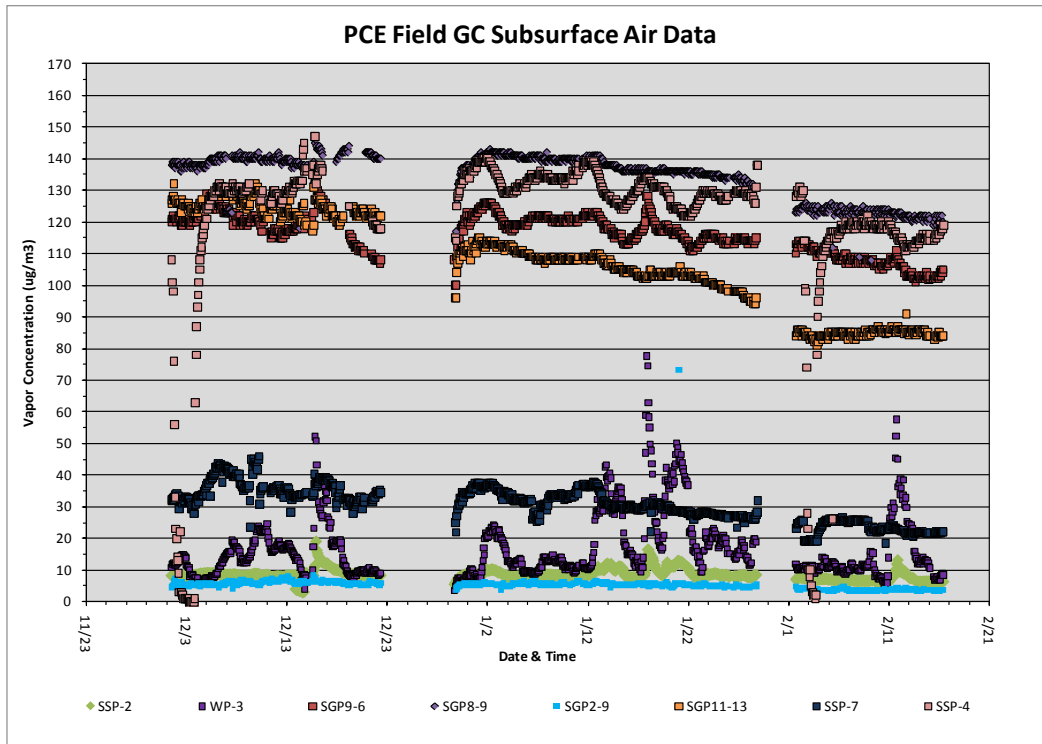

Figure 5-64. Online GC subsurface PCE soil gas data—Phase 2.

that may suggest an effect of the fan tests (discussed in Section 12.2). The SSP-4 drop offs happen more frequently and do not appear to be caused by the fan tests. The TO-17 data for SSP-4 PCE over the whole year also did show considerable variability (Figure 5-65). The pattern of this subslab probe’s plot is reminiscent of Johnson’s observation of data from another house: “There are long periods of relative VI activity with sporadic VI inactivity” (Johnson et al., 2012).

- Probe WP-3 concentrations show repeated high and low variations of a factor of 3 to 5 times occurring over weekly time scales. These fluctuations are similar to the chloroform variations seen in this same probe.

In the second phase of the program (Figure 5-64), the following behaviors were observed:

- Probes SGP2-9 ft, SGP8-9 ft, SGP9-6 ft, SGP11-13 ft, and SSP-7 show slight temporal variations of 20% to 50% over the sampling period.
- Probe SSP-4 is constant within 25% for most of this phase of observation but shows two periods of a rapid drop in values down to near-zero values and then a quick rebound to the predrop values (Figure 5-66). This probe is located very close both spatially and within 18 inches vertically to probe SGP9-6 ft. SGP9-6 ft had similar PCE concentrations and did not show the same rapid variations. However, the drop in values is also seen in the method TO-17 samples of location SSP-4 at other times. This suggests that the behavior at SSP-4 was due to air leakage in the thin void zone that often exists under concrete slabs (DePersio and Fitzgerald, 1995) and thus had less influence on the SGP9-6 ft probe, which had a wider screened interval.

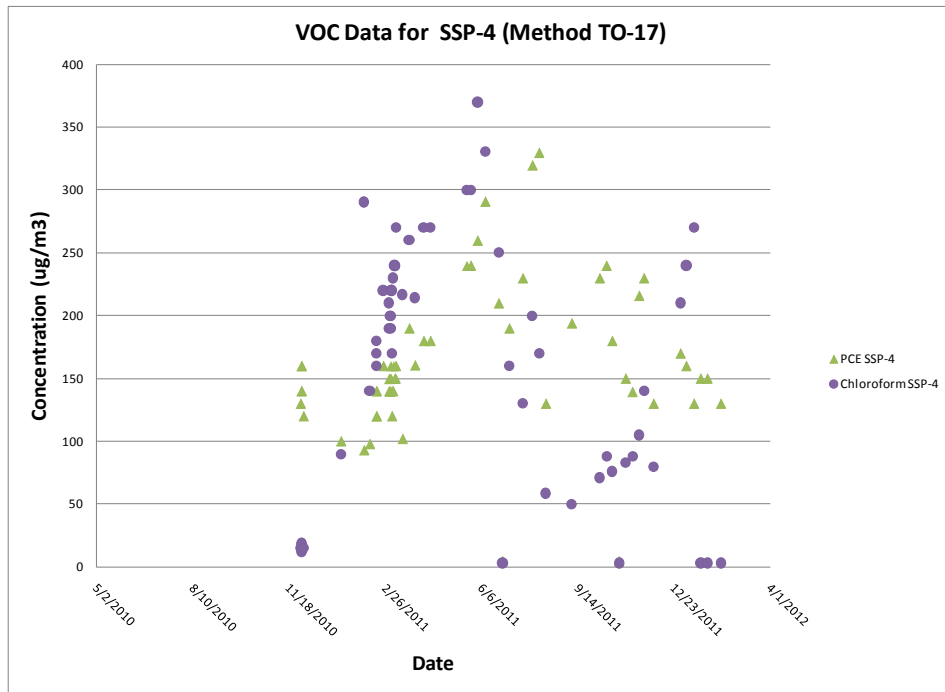

Figure 5-65. Method TO-17 data for SSP-4.

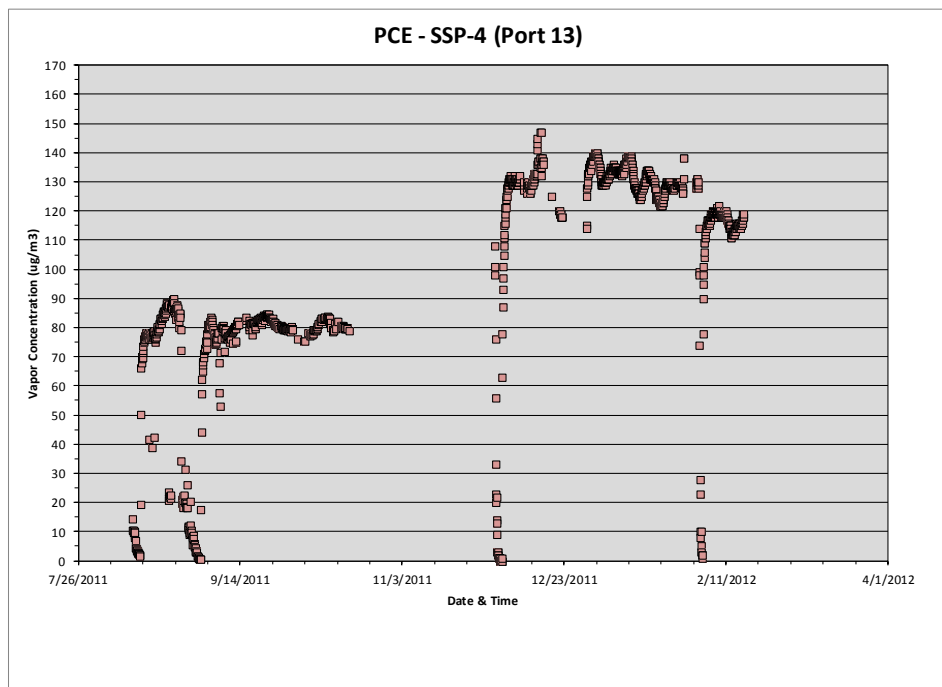

Figure 5-66. Online GC PCE measurements in SSP-4.

- Probe SSP-2 was mostly constant but showed three periods of concentration variations of approximately a factor of 2 lasting over several days each.

- Probes SGP11-13 ft and SSP-7 did not show the rapid drop in values seen during the first phase, suggesting that the behavior in the first phase might indeed be due to valve closure, not actual variations in the soil gas concentrations as discussed above.
- Probe WP-3 continued to show the same oscillations as in the first phase with slightly greater variations of a factor of 5 to 8 times occurring over time scales of several days. These fluctuations are similar to the chloroform variations seen in this same probe.
- The PCE concentrations at locations SGP9-6 ft and SSP-4 decreased slightly over the sampling period in contrast to the CHCl₃ concentrations, which showed large increases in these two probes over the same time period (**Figure 5-67** shows data from SGP9-6). This trend was also observed in the TO-17 sampling of this port during the same time period. This is indicative of different sources for the chloroform and tetrachloroethylene.

In summary, except for probe WP-3, the regular short time scale (< 14 day) temporal variations in PCE seen in all the subsurface probes are typically less than a factor of 2 and generally less than 50%. Probe WP-3 is located closest to the ground surface (~3 ft bgs) so the variations detected might be due to surface influences. Neither rain events, snow events, nor any other changing meteorological conditions seemed to have much effect on the SSPs or on SGPs 6 ft bgs or deeper. SSP-4 showed long periods at relatively steady elevated concentrations punctuated by short intervals of dramatically lower concentrations.

Soil gas concentration variations that were observed at WP-3, and to a lesser extent at SSP-2, occurred over a period of days, indicating that there is little advantage to collecting 24-hour composite samples versus instantaneous grab samples.

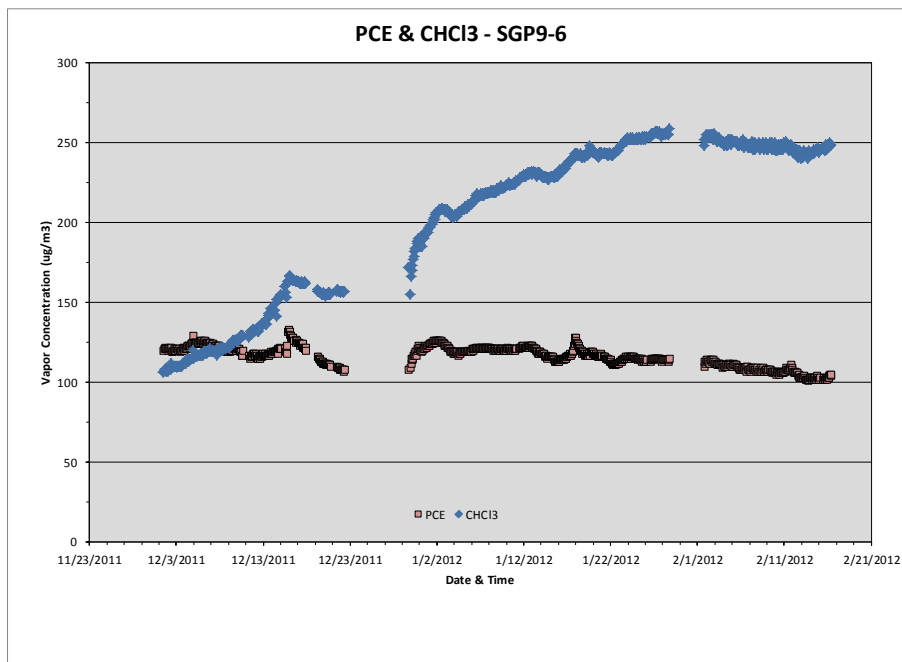

Figure 5-67. Comparison of online GC measurements of PCE and chloroform in SGP9 at 6 ft.

5.4 Radon Short Term Variability (Based on Daily and More Frequent Measurements)

5.4.1 Indoor Air

Indoor air radon was measured during the intensive rounds using E-Perm electrets and Genitron Alphaguard monitors. Electrets were located at all six indoor locations on the 422/420 sides of the house and the ambient location. One stationary Alphaguard was located in the 422 north basement, and the other was located in the 422 upstairs office. At the time of the first intensive round, the stationary Alphaguards were not collecting data, but they were in regular use throughout the rest of the project.

Electret radon data for the first intensive round are shown in **Figure 5-68**. All measurements were higher than ambient, and all of the 422 locations were higher than the 420 locations. This could be explained by the 422 side being the heated side during a fairly cold winter (i.e., a greater stack effect for 422). Also, the south side of the basement usually has higher concentrations on both the 422 and 420 sides of the duplex.

For the second intensive round (across 2 project weeks), the electret radon concentrations showed the opposite pattern to the first intensive round (see **Figures 5-68** and **5-69**), with higher radon concentrations on the 420 side. This could be due to the ACs running on the 422 but not on the 420 side.

The stationary Alphaguard data during the second intensive round are similar downstairs and upstairs (see **Figures 5-70** and **5-71**). The downstairs Alphaguard (**Figure 5-70**) showed a regularly repeated pattern of daily peaks and troughs, with the peaks occurring during the early morning of each day. The upstairs Alphaguard (**Figure 5-71**) showed a similar, but more diffuse, pattern than the downstairs graph. The early-morning peaks may have occurred when the sun shone on 422 basement north and heated that portion of the basement. The more diffuse pattern for the upstairs radon may be from additional mixing of ambient air in the upstairs portion of the house.

The third intensive round electret radon data (**Figure 5-72**) looked very similar to the pattern for the first (**Figure 5-68**). Both occurred during the colder period of the year when the heater was in use on the 422 side of the house. Again, the south side of the house (422 and 420 sides) generally showed greater radon concentrations than other locations.

The stationary Alphaguards for the third intensive show similar patterns for downstairs (**Figure 5-73**) and upstairs (**Figure 5-74**) radon levels, although there were lower concentrations of radon upstairs.

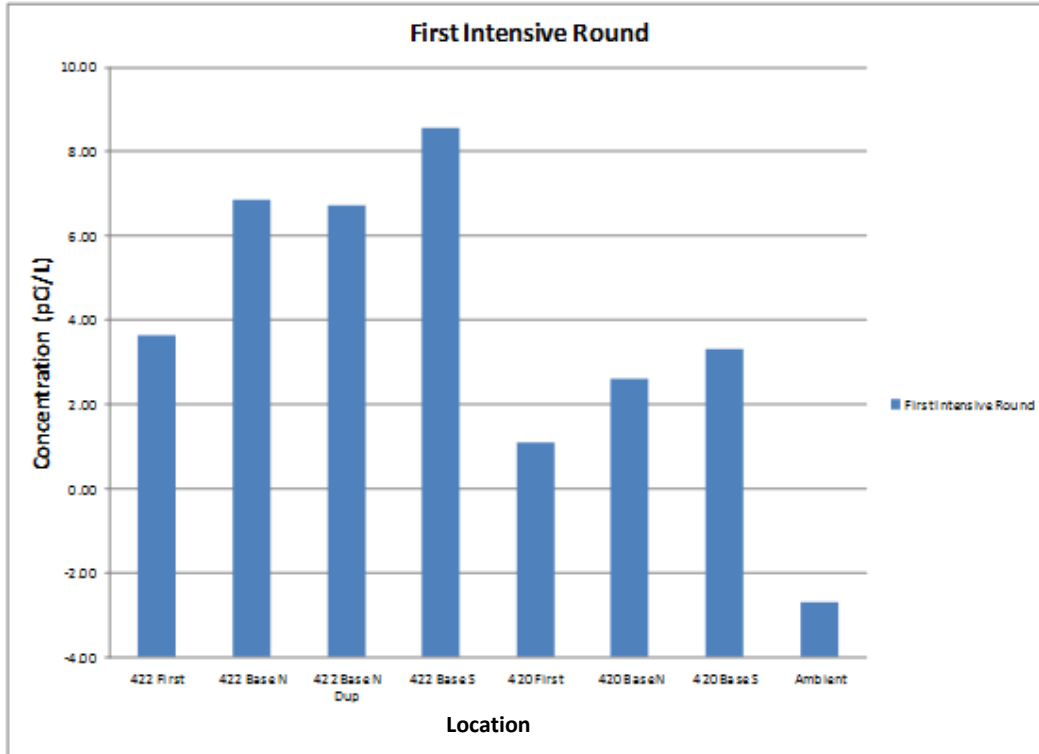

Figure 5-68. Electret indoor air radon concentrations for the first intensive round.

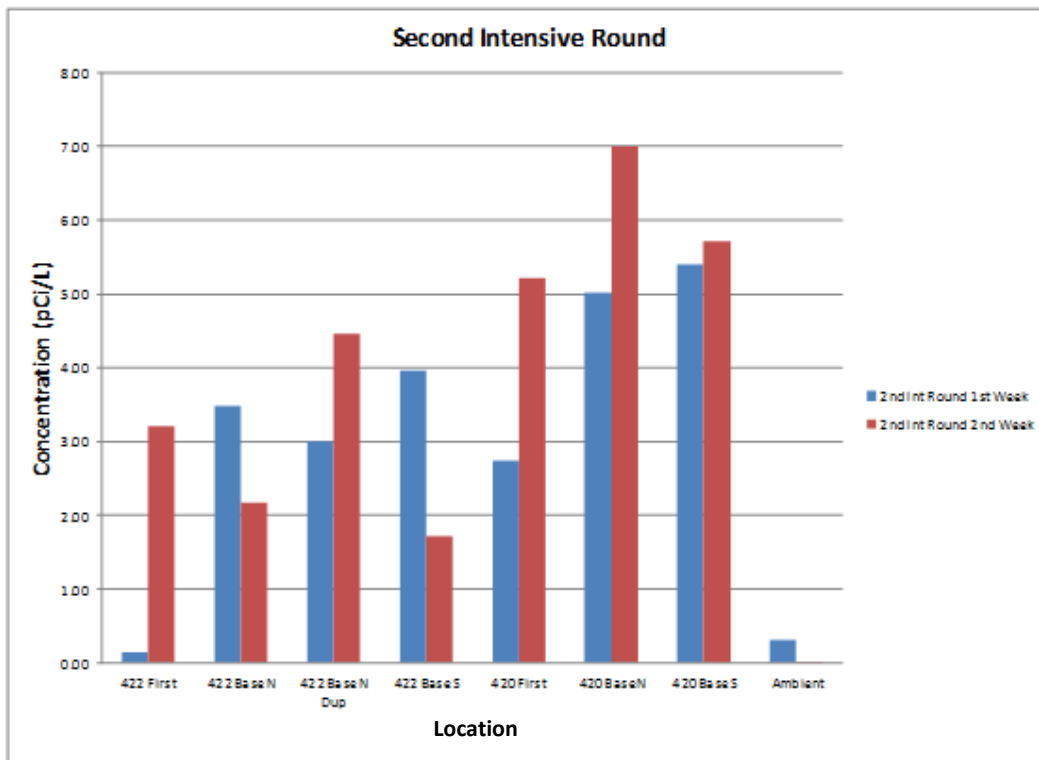

Figure 5-69. Electret indoor air radon concentrations for the second intensive round.

Note that the round lasted for 7 consecutive days across 2 weeks.

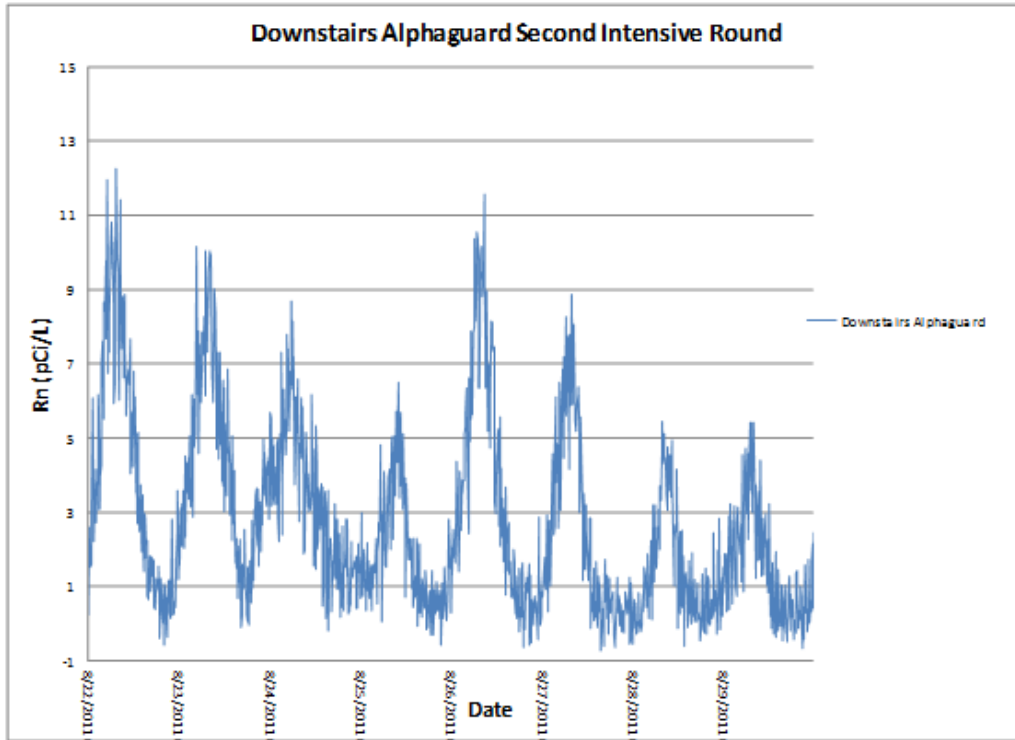

Figure 5-70. Radon concentrations from the downstairs stationary Alphaguard during the second intensive round.

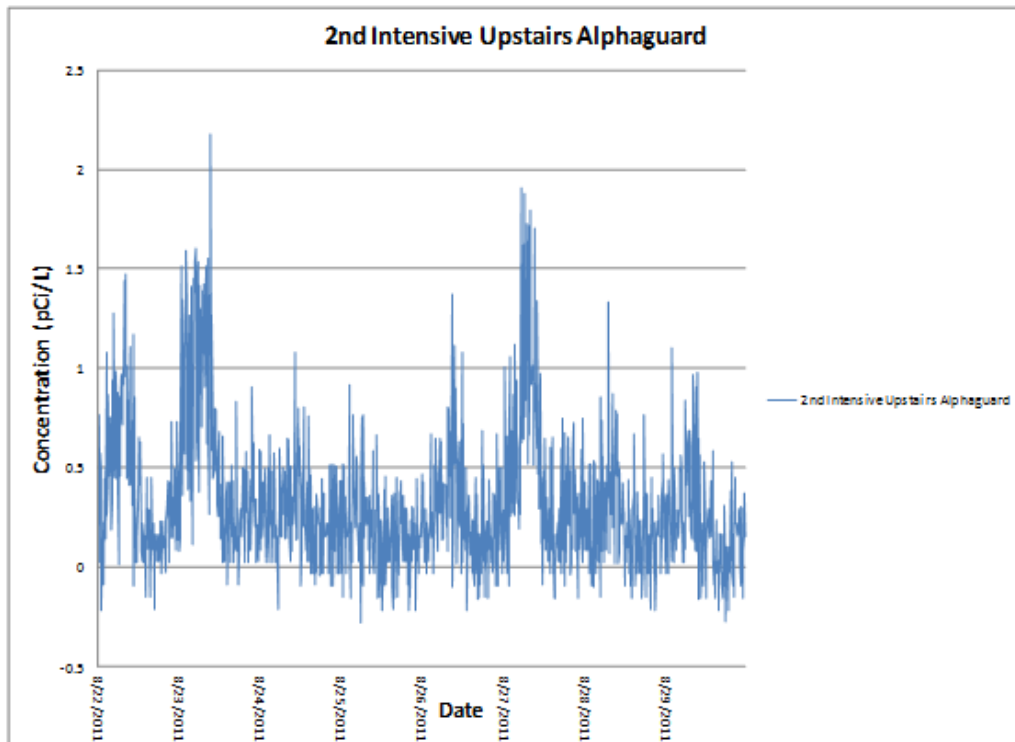

Figure 5-71. Radon concentrations from the upstairs stationary Alphaguard during the second intensive round.

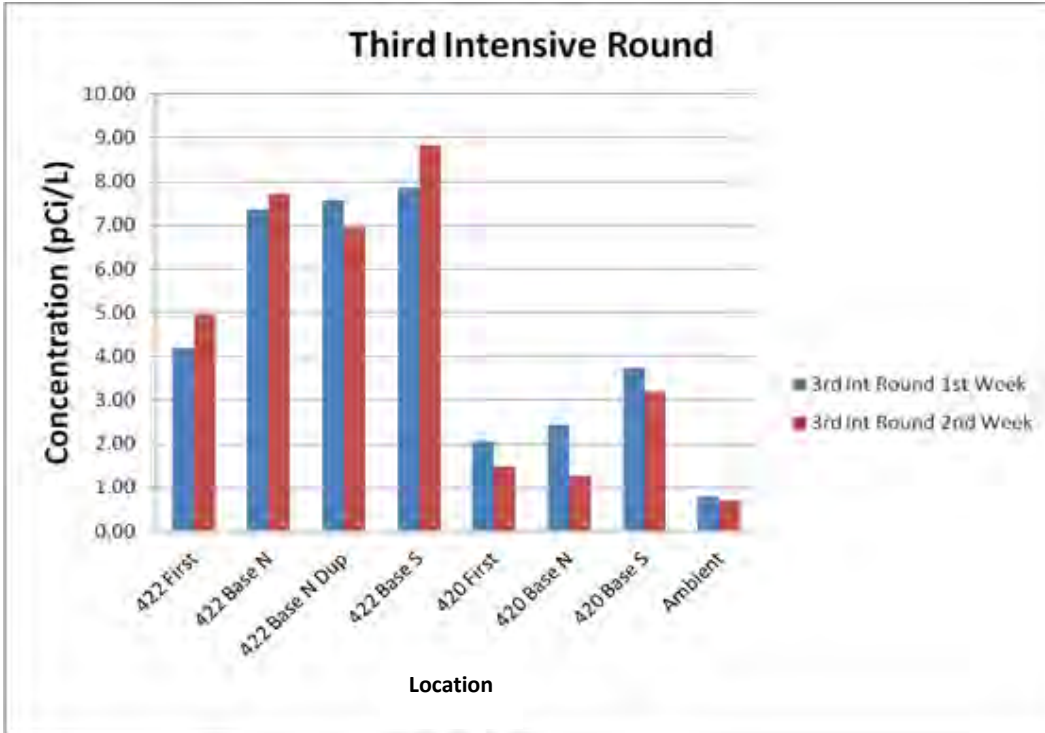

Figure 5-72. Electret indoor air radon concentrations for the third intensive round.
Note that the round lasted for 7 consecutive days across 2 weeks.

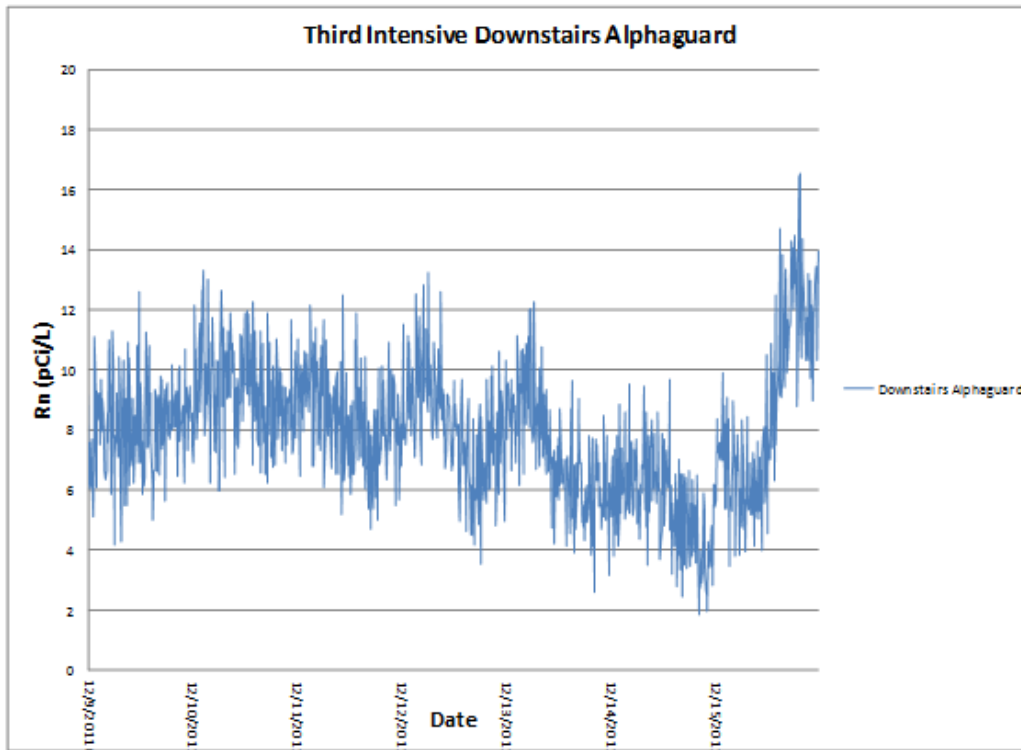

Figure 5-73. Radon concentrations from the downstairs stationary Alphaguard during the third intensive round.

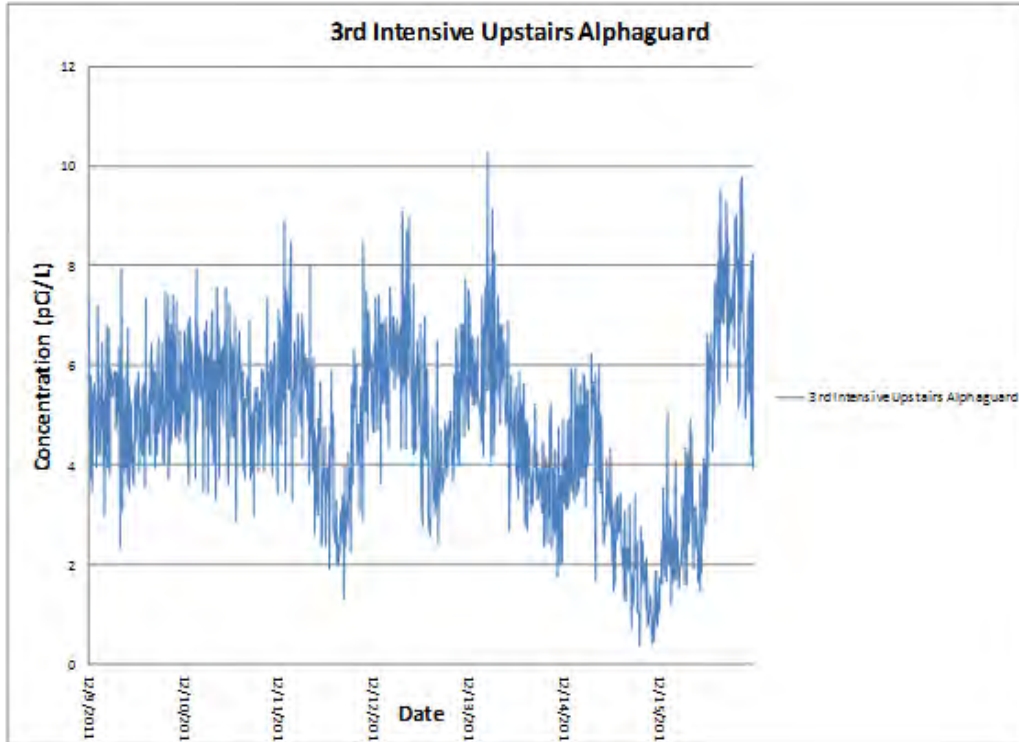

Figure 5-74. Radon concentrations from the upstairs stationary Alphaguard during the third intensive round.

5.4.2 Subslab, Wall Port, and Deeper Soil Gas Radon Data

Subslab, wall, and SGPs were sampled with the Genitron Alphaguard for both the weekly sampling routines and the intensive rounds. The only change for the intensive rounds was the frequency of the sampling, sometimes daily or multiple times per day. These radon data are not included in this report but showed similar trends as in the weekly data discussed in Section 5.2.

5.5 Outdoor Climate/Weather Data

External and internal weather parameters were measured at the 422/420 house on a Vantage Vue weather monitor. Internal temperatures were recorded by HOBO data loggers. Barometric pressure readings were taken about every 15 minutes by Setra pressure sensors. Data were downloaded from these sources approximately once per week. Well water levels were measured approximately once per month.

Table 5-3 presents data from monthly weather summaries for 2011 and 2012 published by the Indiana State Climate Office (Scheeringa, 2011-2012). The 2011–2012 project year can be summarized as an eventful period for Indiana weather. At the beginning of the project, central Indiana received more snow than usual and temperatures in the region started lower than usual. As the weather warmed, central Indiana experienced almost 50 tornadoes with over 60 for the state in 2011 (the usual for the state is ~22 per year [Scheeringa, 2011-2012]). Additionally, in the period of January through March 2012, Indiana experienced 11 tornadoes, about half of the usual yearly allotment. April was the wettest April on Indiana record, and the summer was hot and windy in central Indiana, with an 8-day heat wave in late July. The winter of 2011–2012 had very little snow, and March was the warmest on Indiana record.

Figure 5-75 shows the temperature record from the external temperature monitor and HOBO devices placed at seven indoor locations on the 422 and 420 sides of the house. **Figure 5-76** shows indoor

Table 5-3. Summary Meteorological Data for Central Indiana

Month/Year	State Average T (deg F)	Central IN Average T (deg F)	State Average Precipitation (")	Central Average Precipitation (")	Special Notes on Central IN	Week 1 T Average (deg F)	Notes	Week 2 T Average (deg F)	Notes	Week 3 T Average (deg F)	Notes	Week 4 T Average (deg F)	Notes
January 2011	23.1, 2.9 v	22.3, 3v	1.51, 0.92v	1.63, 0.71v	5 - 12" snow	1 v		3 v		6 v	on 01/21/11, 19 deg F below normal	2 v	
February 2011	30.7	30.5, 0.8 ^	4.17, 2.28^	5.1, 2.98^	4 - 14" snow	2 v	Feb 1 and 2, 3 - 8" snow	4 v	Feb 10, state ave T 17 v	10 ^		2 v	
March 2011	41.4, 0.7 ^	41.3, 1.3 ^	3.5, 0.1 ^	3.7, 0.4 ^		1 ^	2.2" rain	1 ^	0.5" rain	9 ^	0.7" rain	5 v	0.25" rain
April 2011	53.3, 1.9 ^	53.1, 2.3 ^	9.69	9.1, ~5.5 ^	Wettest IN April, 27 tornadoes	4 ^	1.7" rain	4 ^	1.2" rain	3 v	3.4" rain	2 ^	3.0" rain
May 2011	62.5, 0.5 ^	62.4, 0.7 ^	6.47, 2.06 ^	6.03, 1.63 ^	21 tornadoes	5 v	1.8" rain	8 ^	0.6" rain	6 v	0.9" rain	4 ^	2.6" rain
June 2011	72.6, 1.6 ^	72, 1.3 ^	5.34, 1.14 ^	5.4, 1.3 ^		8 ^	~0.5" rain	2 v	1.4" rain	normal	2.1" rain	1 v	0.7" rain
July 2011	79.2, 4.6 ^	79, 4.7 ^	2.79, 1.31 v	1.6, 2.65 v	8-day heat wave	2 ^	0.6" rain	3 ^	0.1" rain	9 ^	0.5" rain	7 ^	0.6" rain
August 2011	72.4, 0.8 ^	72.9, 0.7 ^	2.59, 1.2 v	2.81, 0.95 v	Windy	6 ^	0.5" rain	1 v	1.5" rain	normal	0.1" rain	1 v	0.6" rain
September 2011	63.6, 2 v	63.4, 1.9v	5.39, 2.3 ^	3.56, 2.58 ^	Windy	2 v	0.9" rain	4 v	0.3" rain	normal	1.7" rain	3 v	2.4" rain
October 2011	54, 0.1 ^	53.7, 0.3 ^	3.32, 0.42 ^	3.38, 0.56 ^		1 ^		5 ^	0.4" rain	4 v	2.5" rain	2 v	0.4" rain
November 2011	46.6, 4.2 ^	46.6, 4.7 ^	6.25, 2.66 ^	6.02, 2.38 ^	light snow	normal	0.7" rain	7 ^	0.5" rain	4 ^	1.3" rain	5 ^	3.8" rain
December 2011	36.7, 5.6 ^	36.2, 5.5 ^	4.55, 1.49 ^	5.08, 2.10 ^	light snow	normal	1.5" rain	4 ^	1.3" rain	11 ^	1.1" rain	~9 ^	0.75" rain
January 2012	32.3, 6.3 ^	31.8, 6.4 ^	3.39, 0.96 ^	3.51, 1.17 ^	1-2" snow	7 ^	0.1" rain	7 ^	0.5" rain	2 ^	1.2" rain	18 ^	1.6" rain
February 2012	35.1, 4.5 ^	34.9, 5.1 ^	1.56, 0.73 v	1.34, 0.94 v	1-2" snow	13 ^	0.3" rain	normal	0.2" rain	2 ^	0.3" rain	3^	0.5" rain
March 2012	54.4, 13.7 ^	54.2, 14.1 ^	2.74, 0.66 v	3.38, 0.1 ^	Warmest IN March	4 ^	1.2" rain	20 ^	0.2" rain	26 ^	1.3" rain	9 ^	0.25" rain

Note that the symbols "^" and "v" mean "above" and "below" normal, respectively, and that the weekly values show how the weekly averages differ from normal (from [Scheeringa and Hudson, 2011, 2012](#)).

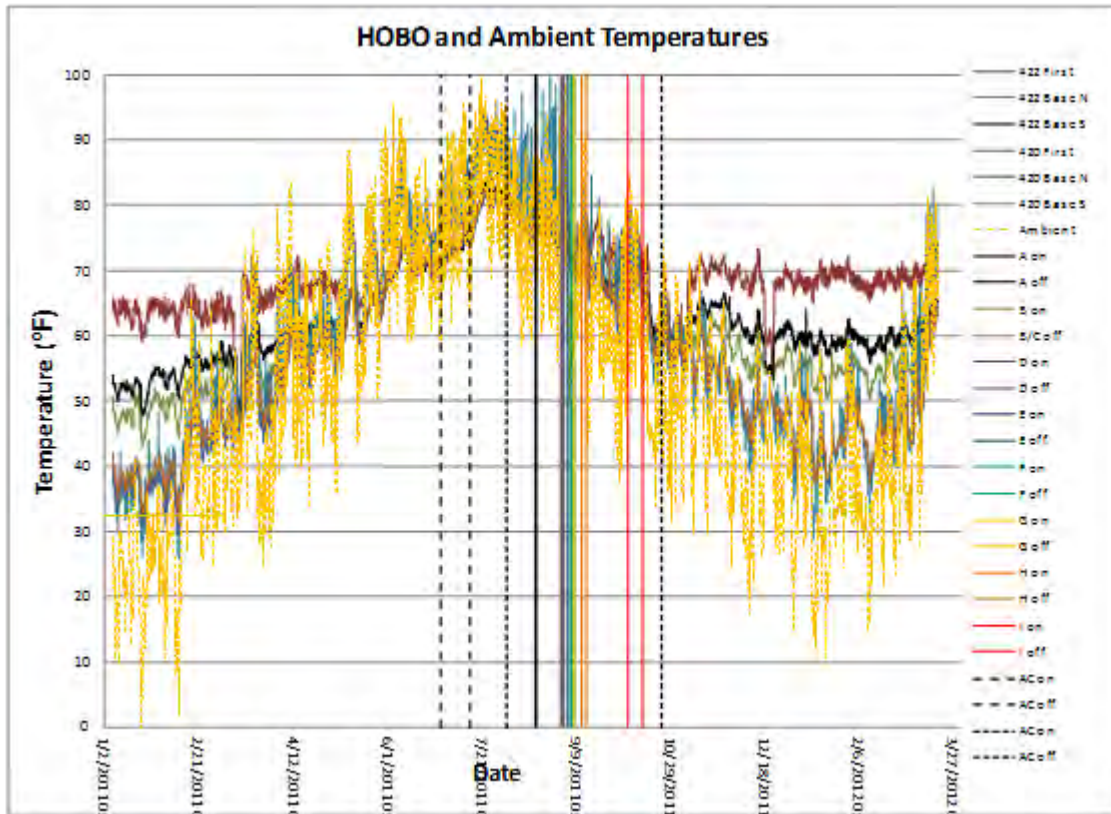

Figure 5-75. Temperature records from the external temperature monitor and the HOBO devices at seven indoor locations on the 422 and 420 sides of the house.

Dashed lines indicate the periods of AC use, and the colored solid lines indicate the fan test times.

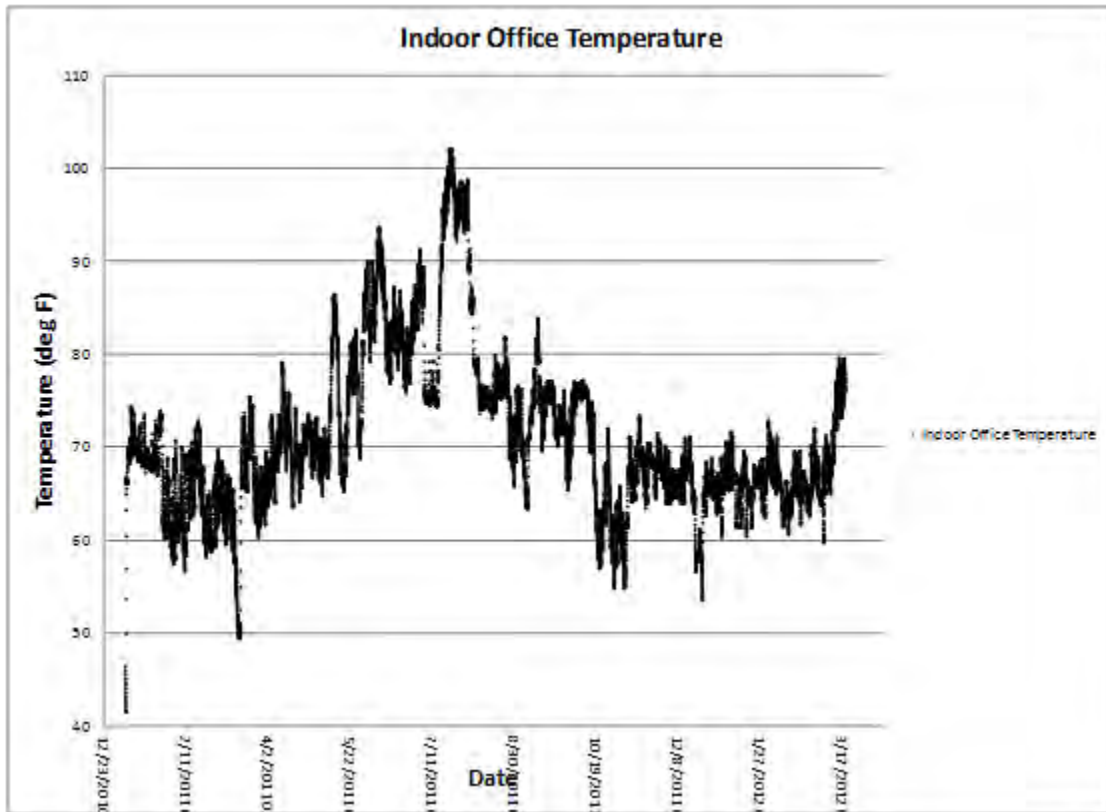

Figure 5-76. Indoor temperature as recorded inside the 422 second floor office.

temperature data recorded in the office set up for this work on the 422 side of the house. The same general trend can be seen in both figures, cycling from the winter lows to the summer highs. The lowest temperature occurred on the unheated 420 first floor at ~26 degrees Fahrenheit on February 10, 2011, and the highest temperature occurred at the 422 office at 102 degrees Fahrenheit on July 21, 2011.

As stated in Section 3.2.1., the gas-fired furnace was run from November 19, 2010 until June 22, 2011, and then from November 7, 2011, until June 1, 2012, on the 422 side only, with no heating unit on the 420 side. Initially, window-mounted ACs ran on both sides of the duplex from June 29, 2011 until July 12, 2011. When the ACs were replaced, they were replaced on the 422 side only and ran from March 3, 2011, until October 24, 2011. **Figures 5-75** and **5-76** show some of the highest temperatures occurring during the period between the AC theft and when they were replaced on the 422 side, along with higher temperatures on the 420 side where the AC units were not replaced. The higher temperatures between AC periods could be a result of the solar stack effect, which may have been driving the higher radon and VOC concentrations observed during that time (see Section 5.2.1).

Temperature lows seen in **Figures 5-75** and **5-76** track fairly well with what is represented in Table 5-3, as the external temperature line (yellow line of **Figure 5-75**) and the internal HOBOS on the unheated 420 side of the house (light blue, dark blue, tan lines of **Figure 5-75**) show. Highs for the summer heat wave also can be seen on both figures.

The most obvious features of the stacked hydrological graph of **Figure 5-77** are the prominent highs in rainfall and stream discharge, coupled with the high water levels measured during gauging. These highs align well with the period of heavy snowfall and rain experienced in central Indiana (see **Table 5-3**). Dips

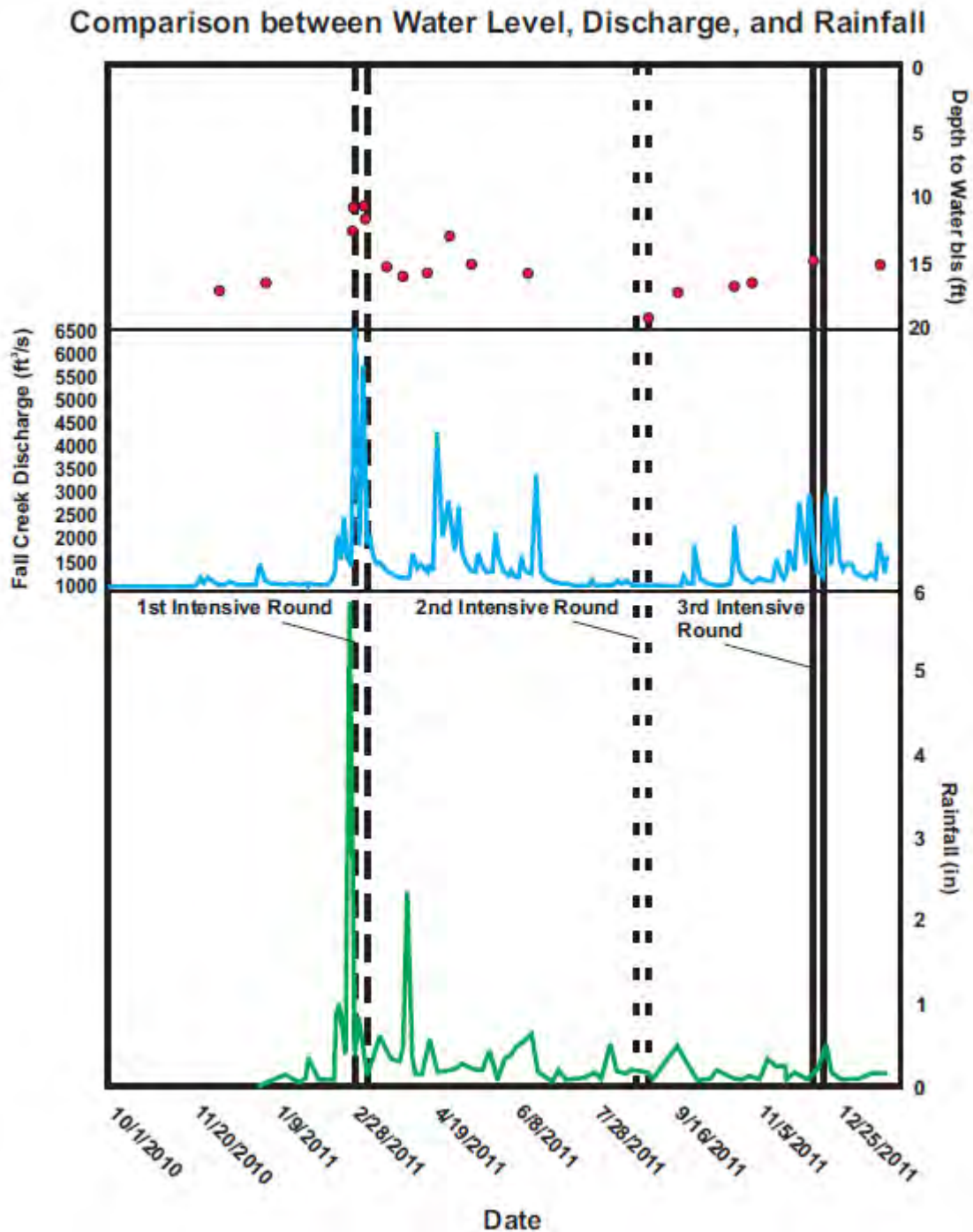

Figure 5-77. Stacked hydrological graph with depth to water in feet (top—red circles), discharge at Fall Creek in ft³/s (middle—blue line), and rainfall in inches (bottom—green line).

All are over time for the duration of the project. Intensive sampling rounds are marked by dashed and solid lines.

in stream discharge and the lower depths during well gauging match well with the much hotter drier summer period.

Transition weather can be quite turbulent, and much of the 2011–2012 year seemed like transition weather, with its tornadoes, record highs, and rainy periods (see **Table 5-3**). **Figures 5-78** and **5-79** show pressure readings taken outside the 422/420 house (**Figure 5-78**) and inside (**Figure 5-79**). For the time period represented by this report (January 2011 through March 2012), the figures are fairly similar, with prominent highs and lows during the cooler seasons and transitional weather times and more stable periods during the warmer months.

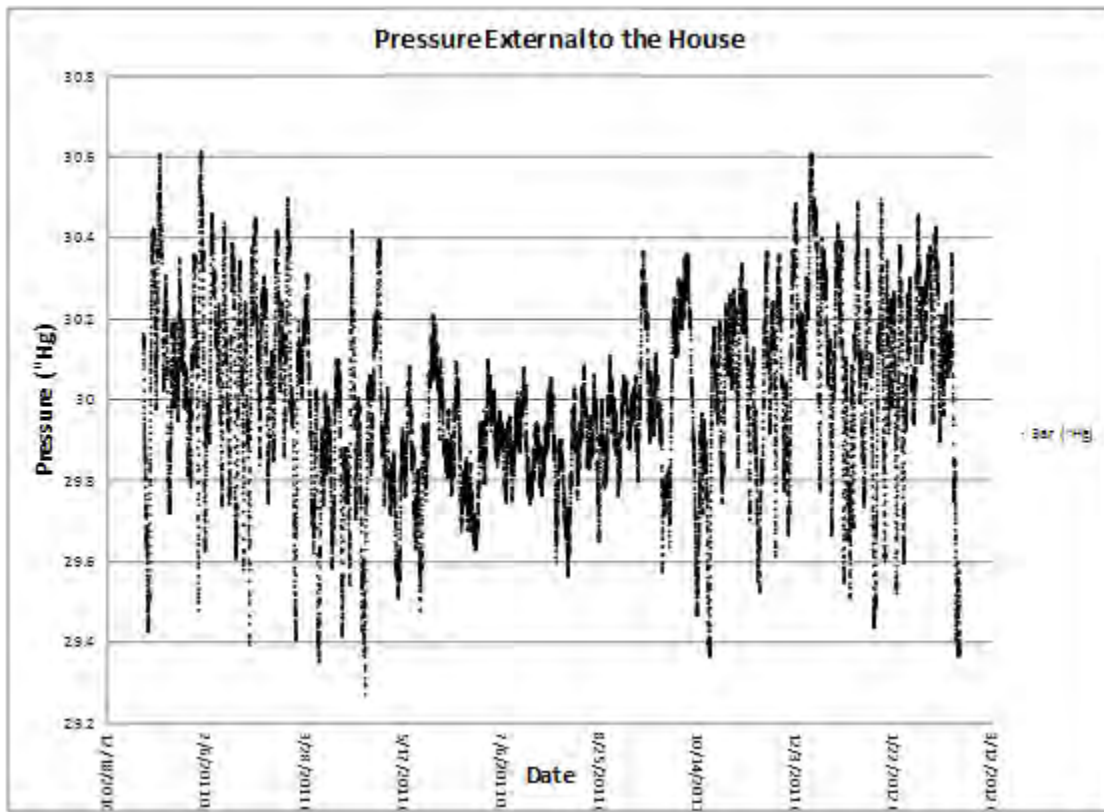

Figure 5-78. Plot of barometric pressure (inches of Hg) external to the 422/420 house over time.

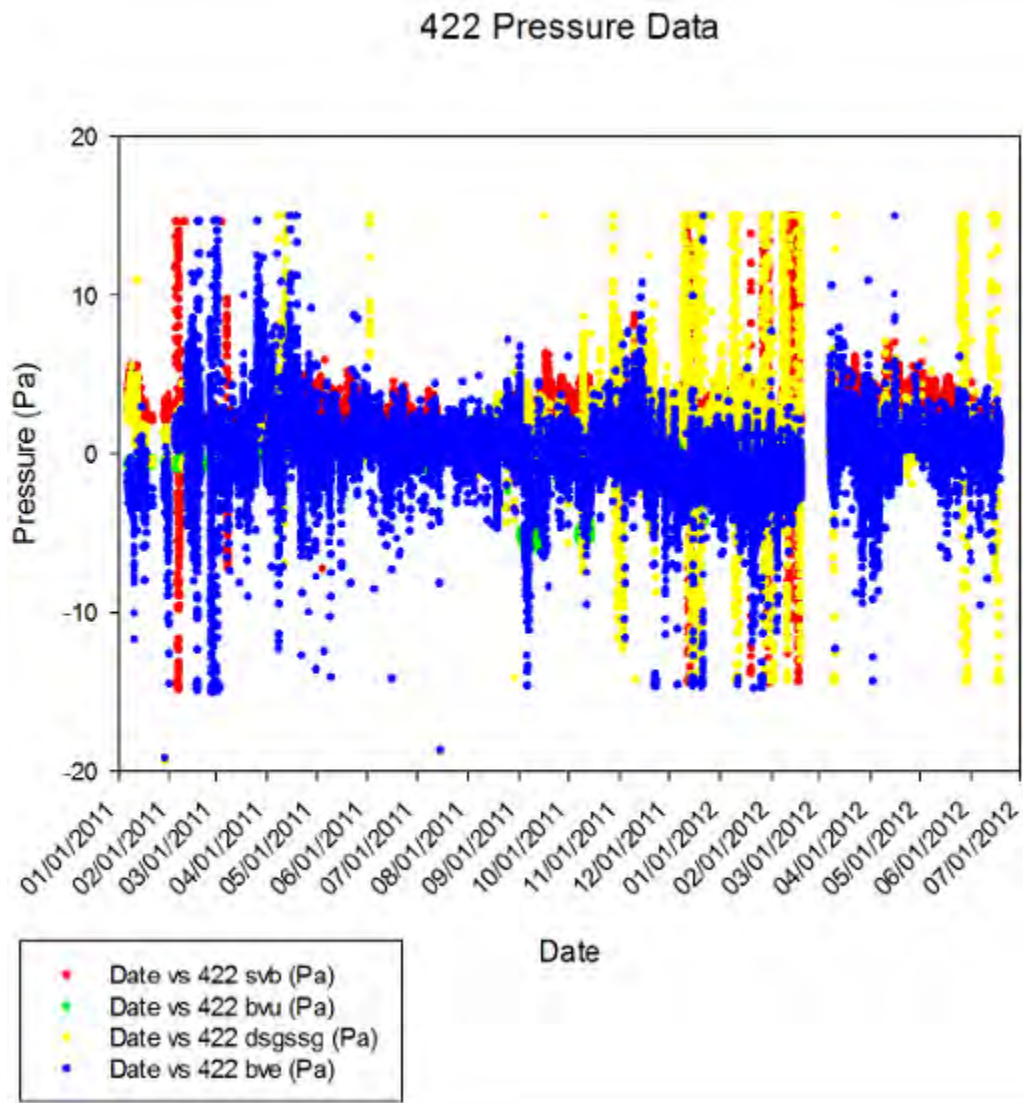

Figure 5-79. Barometric pressure (Pa) on the 422 side of the house over time.

Table of Contents

6.	Results and Discussion: Establishing the Relationship between VOCs and Radon in Subslab/Subsurface Soil Gas and Indoor Air	6-1
6.1	Correlation between Soil Gas VOC and Radon Concentrations	6-3
6.2	Correlation between the Indoor Air Concentration and Radon	6-15
6.3	Radon and VOC Soil Gas Spatial Distributions	6-16
6.4	Spatial Correlations in Radon and VOCs Analyzed Separately	6-18
6.5	Correlations in Indoor Air VOC and Radon Temporal Trends	6-22

List of Figures

6-1.	Temporal trends and cross-correlograms of chloroform (red), PCE (green), and radon (blue) for SGP11 at 6 ft bls.	6-4
6-2.	Temporal trends and cross-correlograms of chloroform (red), PCE (green), and radon (blue) for SGP1 at 9 ft bls.	6-5
6-3.	Temporal trends and cross-correlograms of chloroform (red), PCE (green), and radon (blue) for SGP4 at 9 ft bls.	6-6
6-4.	Temporal trends and cross-correlograms of chloroform (red), PCE (green), and radon (blue) for SGP4 at 13 ft bls.	6-7
6-5.	Temporal trends and cross-correlograms of chloroform (red), PCE (green), and radon (blue) for SGP5 at 9 ft bls.	6-8
6-6.	Temporal trends and cross-correlograms of chloroform (red), PCE (green), and radon (blue) for SGP7 at 9 ft bls.	6-9
6-7.	Temporal trends and cross-correlograms of chloroform (red), PCE (green), and radon (blue) for SGP8 at 6 ft bls.	6-10
6-8.	Temporal trends and cross-correlograms of chloroform (red), PCE (green), and radon (blue) for SGP9 at 6 ft bls.	6-11
6-9.	Temporal trends and cross-correlograms of chloroform (red), PCE (green), and radon (blue) for SGP10 at 6 ft bls.	6-12
6-10.	Temporal trends and cross-correlograms of chloroform (red), PCE (green), and radon (blue) for SGP11 at 6 ft bls.	6-13
6-11.	Temporal trends and cross-correlograms of chloroform (red), PCE (green), and radon (blue) for SGP12 at 6 ft bls.	6-14
6-12.	Cross-correlation plots for the time series of log-VOCs and radon by indoor air location.	6-15
6-13.	Comparison of nearly collocated subslab and shallow internal soil gas ports.	6-17
6-14.	Concentration distributions ($\mu\text{g}/\text{m}^3$ [VOCs] or pCi/L [radon]) and significance tests for nearly collocated subslab and shallow internal soil gas ports.	6-18
6-15.	Evaluation of spatial effect north and south basement by VOC and radon for 422 East 28th St.—cumulative distribution plots where the x axis represents concentration ($\mu\text{g}/\text{m}^3$ or pCi/L) and the y-axis concentration.	6-19
6-16.	Evaluation of spatial effect north and south basement by VOC and radon for 420 East 28th Street—cumulative distribution plots where the x axis represents concentration ($\mu\text{g}/\text{m}^3$ or pCi/L) and the y-axis concentration.	6-19
6-17.	Cross-correlation between north and south basement indoor air by VOCs and radon.	6-20
6-18.	Comparison of temporal trends at north and south basement sampling locations.	6-21
6-19.	Autocorrelation function for chloroform, PCE, and radon by location (site and north/south basement).	6-23

List of Tables

6-1. Counts of Records with Flag by VOCs and Flag Type for Soil Gas6-1
6-2. Counts of Records with Flag by VOCs and Flag Type for Indoor Air6-2
6-3. Comparison of Mean and Median Concentrations in North and South Sampling
Locations, 422 Side of Duplex..... 6-22

6. Results and Discussion: Establishing the Relationship between VOCs and Radon in Subslab/Subsurface Soil Gas and Indoor Air

In this chapter we explore whether radon, a parameter that can be inexpensively and rapidly analyzed in the field, correlates with VOCs for which field analysis is more difficult and costly. In the statistical analysis of environmental data, the number of nondetects affects the precision of estimates. As the level of censoring due to nondetects or data quality issues increases, most of the correlation methods result in highly biased correlation estimates (Newton and Rudela, 2007). To begin to assess the significance of detection-limit limitations on the data from this study, we looked at flags related to data quality in the study database. **Tables 6-1** and **6-2** display the number and types of flags in the data for radon and for each VOC measured in soil gas and indoor air, respectively. For soil gas, the proportion of nondetects ranged from 23% (benzene) to 93% (hexane). A large proportion of nondetects also were reported for trichloroethene¹ (TCE, 89%) and toluene (78%). For indoor air, only cis-1,2-dichloroethene² (cis-1,2_DCE, 84%) shows nondetects. Because the proportion of nondetects in soil gas was reasonable (no more than 50%, see Helsel [2005] for more detail), and because these compounds appear to be from

Table 6-1. Counts of Records with Flag by VOCs and Flag Type for Soil Gas

Flag Type	Radon	PCE	TCE	Chloroform	Benzene	Hexane	Toluene
U	0	576	2,098	853	594	2,147	1,908
J	0	126	127	226	284	131	235
E	0	0	0	0	0	0	0
B	0	14	0	28	965	0	122
Q	0	0	0	0	0	0	0
I	0	477	312	499	492	323	337
S	0	52	51	52	49	50	49
C	0	174	1	117	9	17	1
ND	0	46	192	50	11	243	104
% Nondetect	0	24%	89%	35%	23%	93%	78%

U Compound not detected and reported as MDL

J Compound concentration is estimated because detection was between the lowest calibration standard concentration and the MDL

E Compound concentration is estimated because the concentration was above the highest calibration standard concentration

B Compound concentration is flagged because the compound was detected in the associated method blank

Q Value failed project QC criteria

I Associated internal standard failed project QC criteria

S Associated surrogate standard failed project QC criteria

C Associated calibration verification standard failed project QC criteria

ND Nondetect

¹ Includes flags U and nondetect

¹ Also known as trichloroethylene

² Also known as cis-1,2-dichloroethylene

Table 6-2. Counts of Records with Flag by VOCs and Flag Type for Indoor Air

Flag Type	Radon	Benzene	Chloroform	cis-1,2-DCE	Hexane	PCE	Toluene
U	0	0	0	0	0	0	0
J	0	18	164	53	0	91	0
E	0	0	0	0	0	0	0
B	0	0	0	0	0	0	0
Q	0	0	0	0	0	0	0
I	0	0	0	0	0	0	0
S	0	0	0	0	0	0	0
C	0	0	0	360	0	0	0
ND	0	0	12	350	0	0	0
% Nondetect	0 %	0 %	2.9 %	84 %	0 %	0 %	0 %

- U Compound not detected and reported as below MDL
- J Compound concentration is estimated because detection was between the lowest calibration standard concentration and the MDL
- E Compound concentration is estimated because the concentration was above the highest calibration standard concentration
- B Compound concentration is flagged because the compound was detected in the associated method blank
- Q Value failed project QC criteria
- I Associated internal standard failed project QC criteria
- S Associated surrogate standard failed project QC criteria
- C Associated calibration verification standard failed project QC criteria
- ND Nondetect
- ¹ Includes flags U and nondetect

subsurface sources based on other lines of evidence (see Section 11), we decided to focus the VOC and radon analysis on tetrachloroethene³ (PCE, 24% nondetect) and chloroform (35% nondetects).

In environmental science it is not uncommon to observe shifts in time in the correlation between two time series. For example, one series may have a delayed response to the other series or perhaps a delayed response to a common stimulus affecting both series. The simple correlation coefficient between two series properly aligned in time is inadequate to characterize the relationship in such situations. An alternative is the cross-correlation function, which takes into account the possible lagged correlation between the two time series. The cross-correlation function can assume values between -1 and 1, with a high correlation indicating a periodicity in the signal of the corresponding time duration. Lag k cross-correlation coefficient explores the correlation between week t from series 1 with week t+k in series 2. The cross-correlation at lag 0 has a similar interpretation as the Pearson correlation coefficient.

To assess the correlation between the radon time series and each of the VOC time series, cross-correlation coefficients were calculated at several lags, measured in weeks. A positive cross-correlation at lag 1 coefficient suggests that observing increments of radon in 1 week is associated with an increasing trend in VOCs 1 week later. Similarly, a negative cross-correlation of lag k suggests that an increasing trend in radon is correlated with a decreasing trend in the VOCs observed k weeks later.

³ Also known as tetrachloroethylene

Critical bounds were calculated at the 5% significant level, given by $\pm \frac{2}{\sqrt{n}}$ to determine the significance of the cross-correlation coefficients. If any of the cross-correlations exceeds the cutoff $\pm \frac{2}{\sqrt{n}}$ then the cross-correlation coefficient is deemed statistically significant from zero. The significance of the cross-correlation coefficient is interpreted as a sign of positive or negative correlation between radon and the VOCs at k weeks apart. Significant lags on both sides of 0 suggest that the relationship between the time series goes two ways (one does not drive the other), which we would expect to see because changes in radon do not directly cause VOC concentration rises, but there are a common collection of factors that affect them both. Multiple significant lags means that the relationship is “smeared” in time—the concentration of radon today is related to the concentration of PCE today, tomorrow, and the next day for example. This also makes physical sense because the average residence time of VOCs in soil gas is higher than that for radon at depth because of the relatively short half-life of radon. Significant correlations at large lags may suggest some type of noise in the data that may result from autocorrelation of any of the time series.

6.1 Correlation between Soil Gas VOC and Radon Concentrations

The correlation between the soil gas concentration for two VOCs (PCE and chloroform) and radon was investigated using the cross-correlation function for the combinations of soil gas probe sites and depths with a sample size large enough to allow analysis. **Figure 6-1** shows temporal trends from an example time series for the two VOCs and radon in soil gas at one soil gas probe site and depth (6 ft bls in SGP11). The second panel in **Figure 6-1** shows the correlograms for evaluating the correlation between the two VOCs and radon at 6 ft bls in the same soil gas probe (SGP1). Blue lines denote the confidence bands; spikes exceeding these confidence bands represent cross-correlations that are statistically significant suggesting that the VOCs and radon are correlated at that lag time. For a 6 ft bls, only chloroform is negatively correlated with radon in 2-week lag. Significant spikes in the correlograms in the diagonal suggest autocorrelation for both VOCs and radon. Auto-correlation is to be expected in these data sets, since soil gas concentrations change slowly at this site with respect to the weekly frequency of the measurements performed.

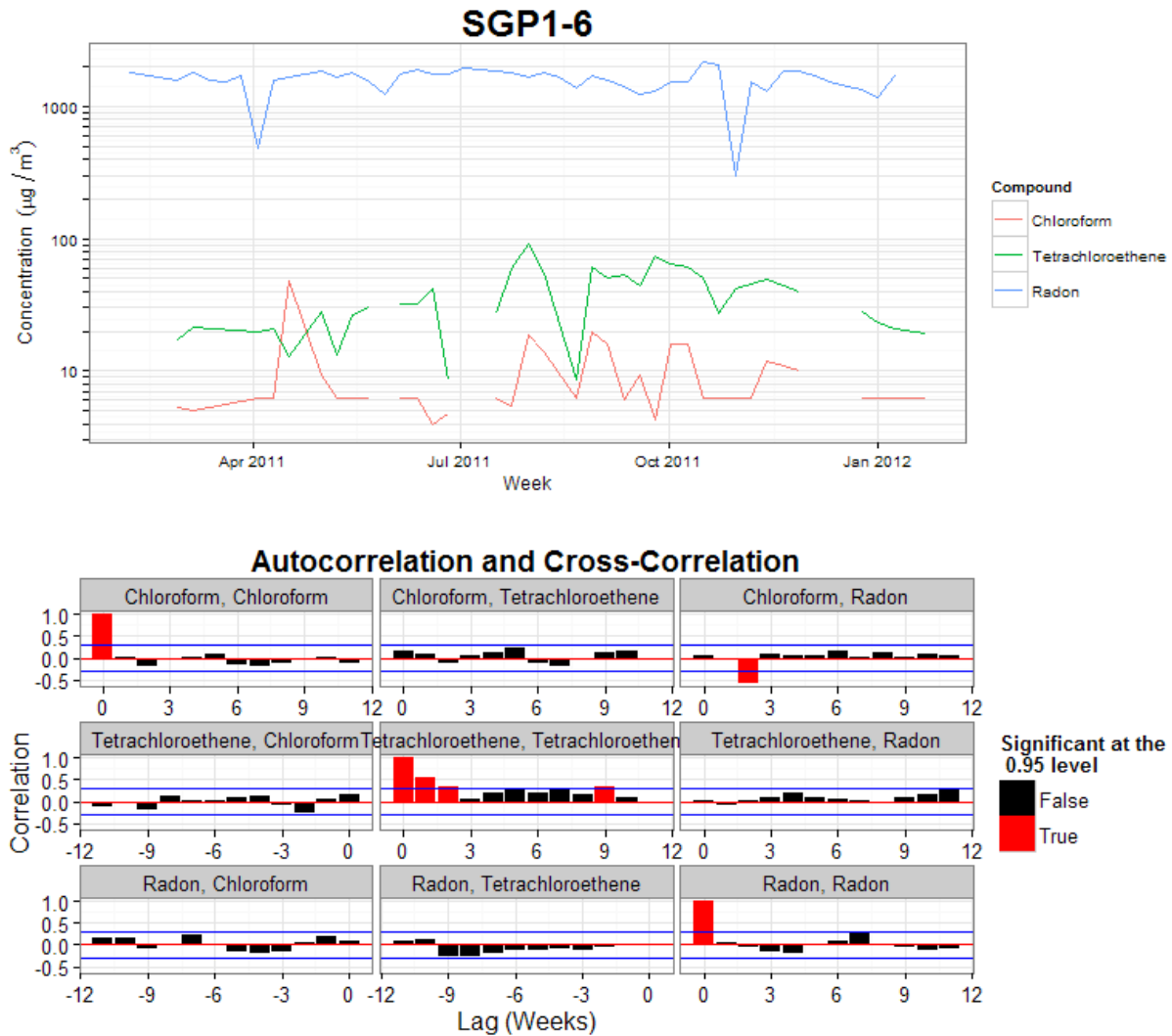

Figure 6-1. Temporal trends and cross-correlograms of chloroform (red), PCE (green), and radon(blue) for SGP11 at 6 ft bls.

Note that radon concentrations are plotted in pCi/L.

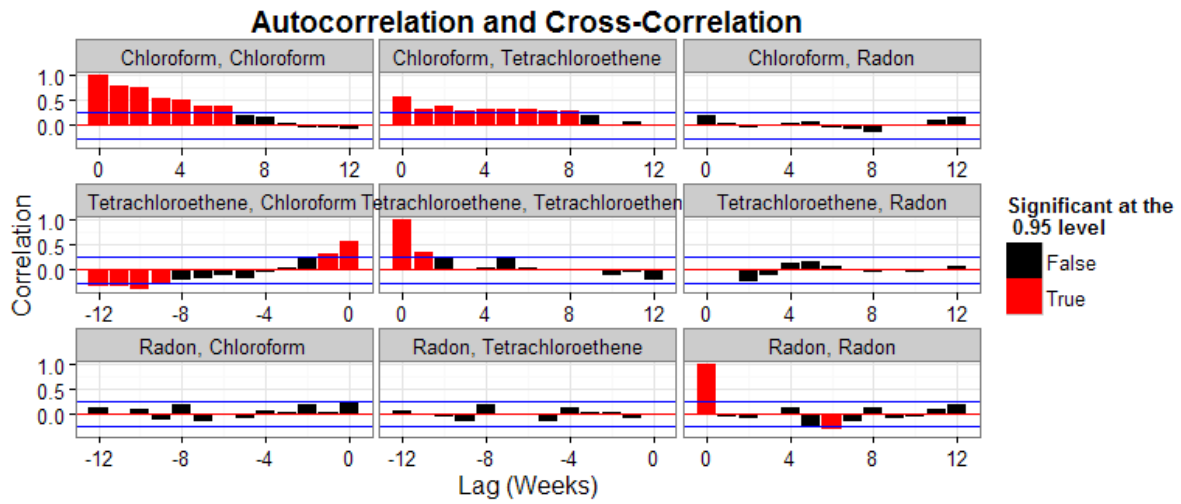
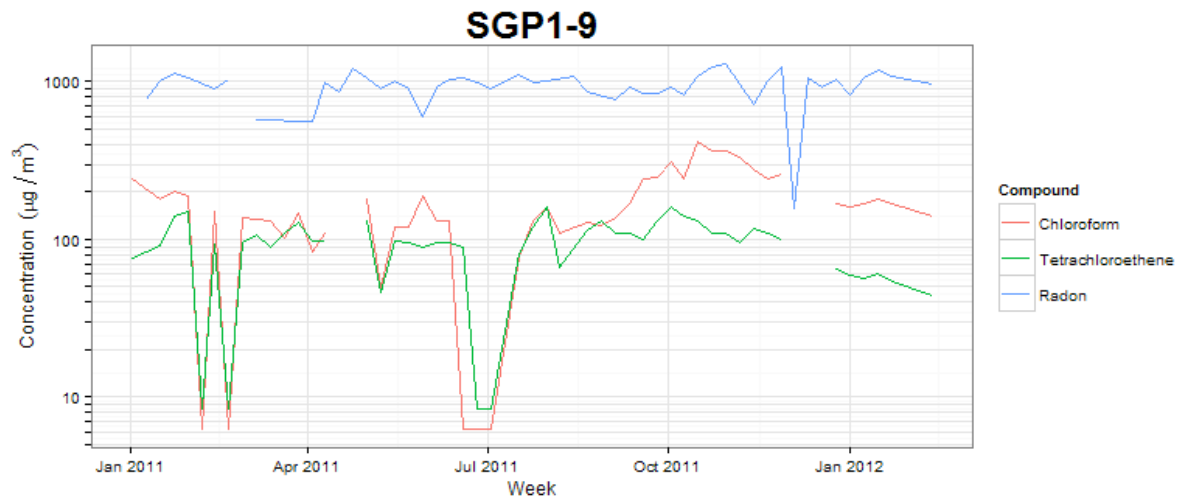

Figure 6-2. Temporal trends and cross-correlograms of chloroform (red), PCE (green), and radon (blue) for SGP1 at 9 ft bls.

Note that radon concentrations are plotted in pCi/L.

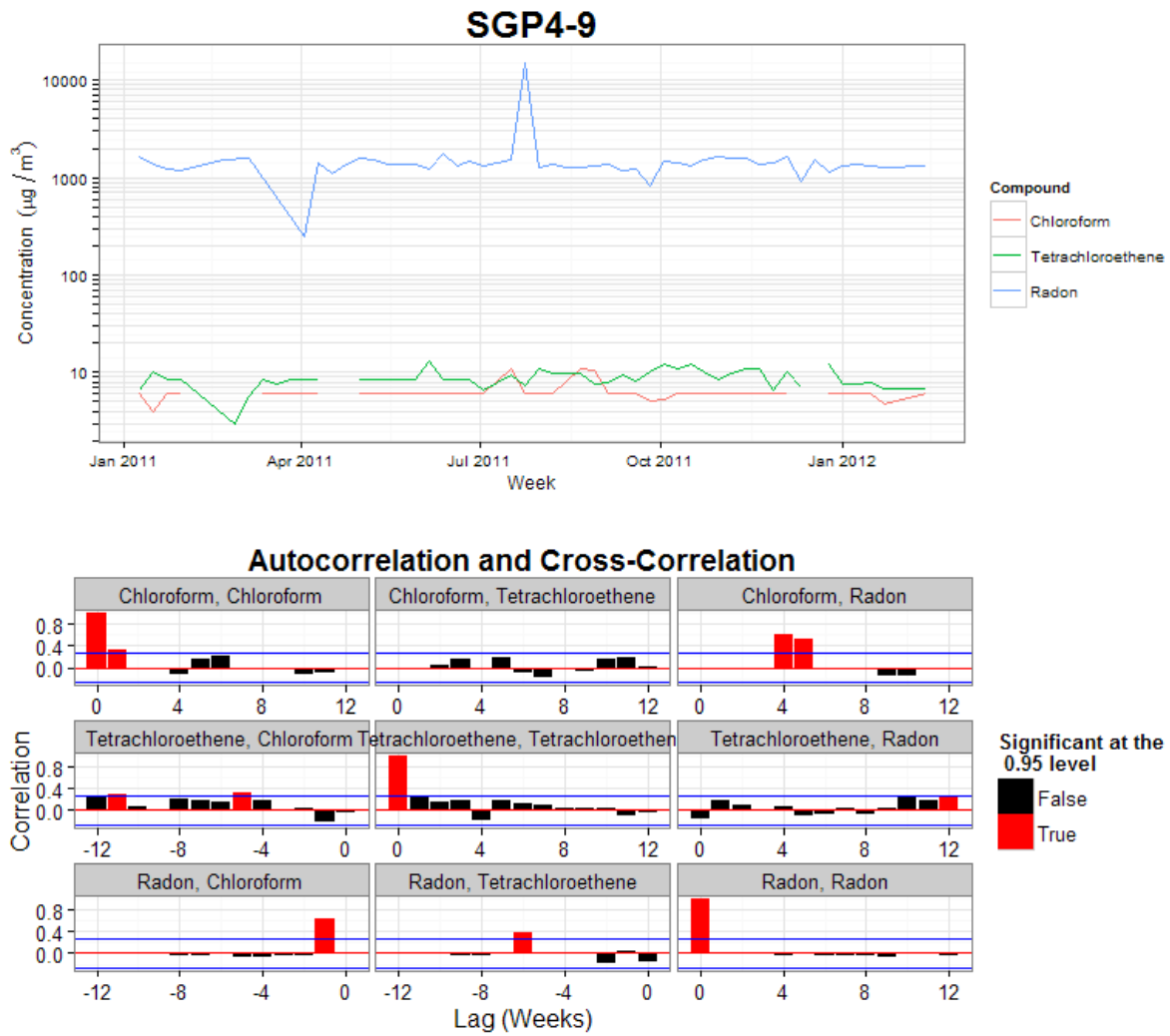

Figure 6-3. Temporal trends and cross-correlograms of chloroform (red), PCE (green), and radon (blue) for SGP4 at 9 ft bls. Note that radon concentrations are plotted in pCi/L.

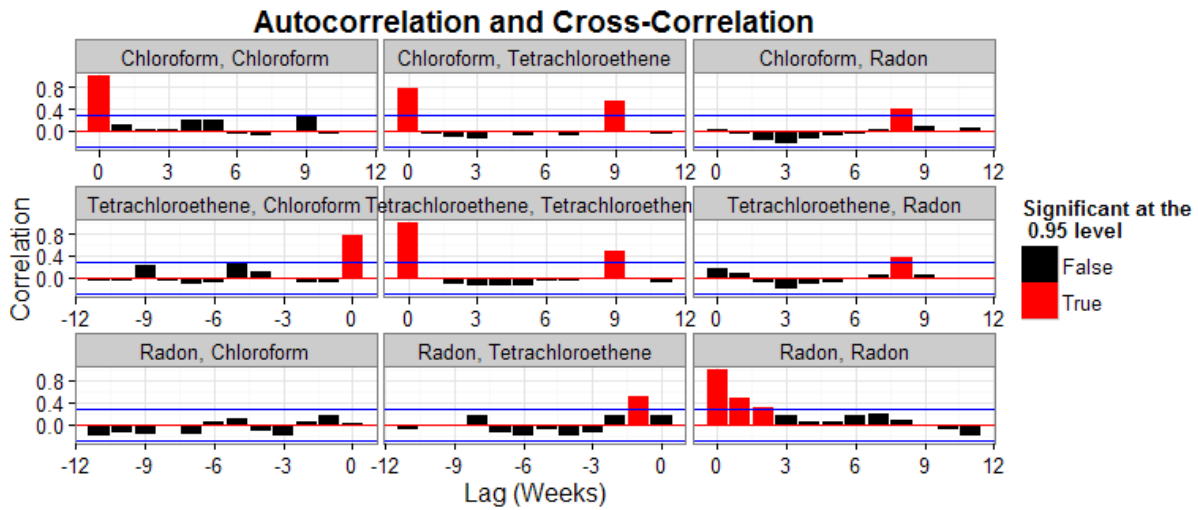
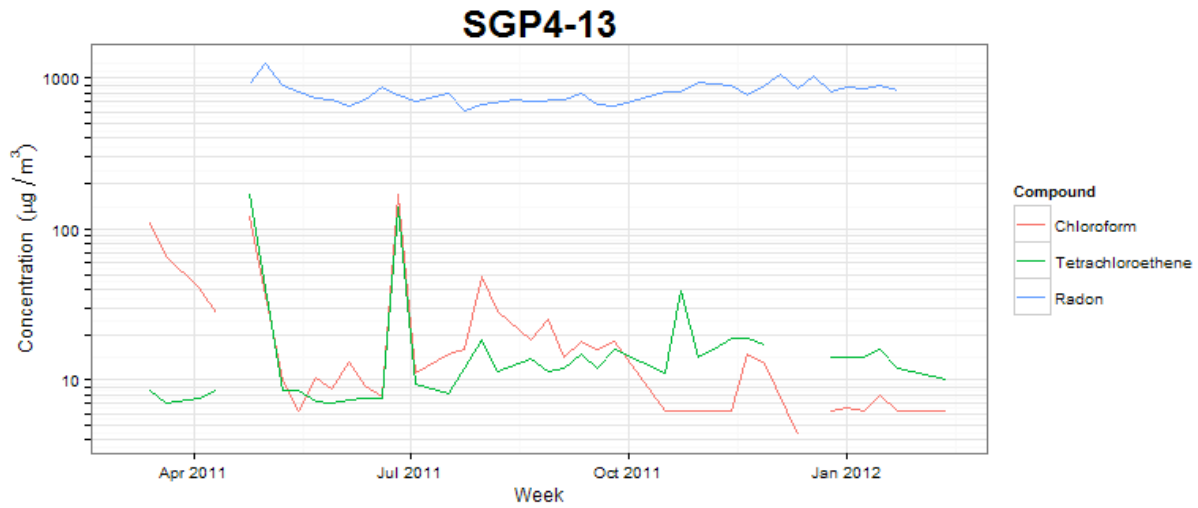

Figure 6-4. Temporal trends and cross-correlograms of chloroform (red), PCE (green), and radon (blue) for SGP4 at 13 ft bls.

Note that radon concentrations are plotted in pCi/L.

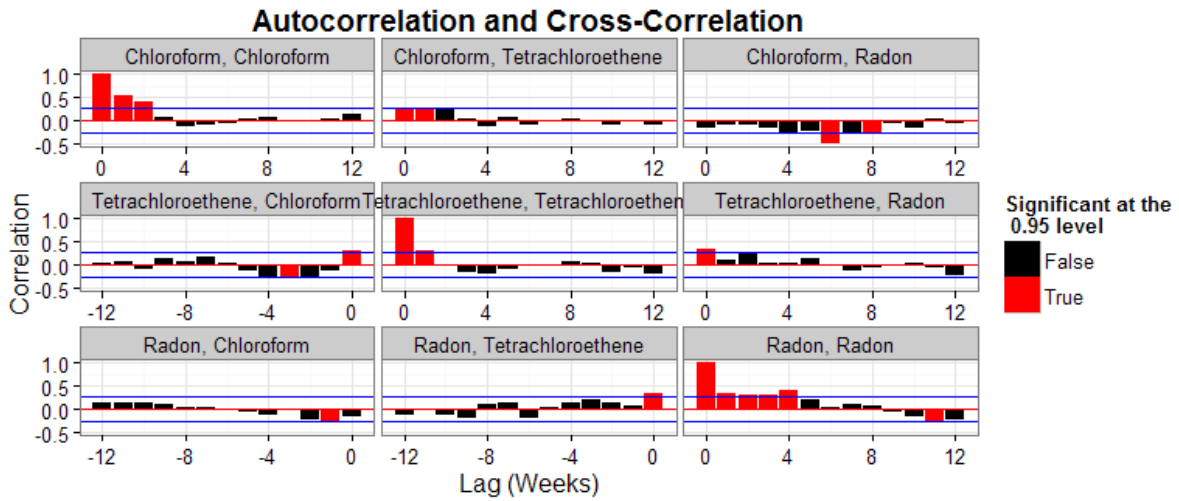
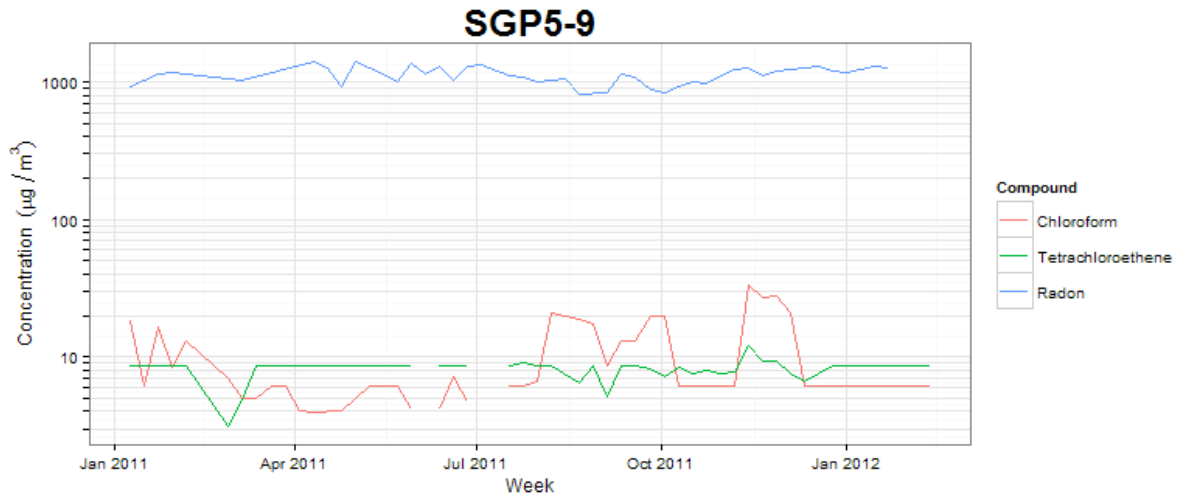

Figure 6-5. Temporal trends and cross-correlograms of chloroform (red), PCE (green), and radon (blue) for SGP5 at 9 ft bls.

Note that radon concentrations are plotted in pCi/L.

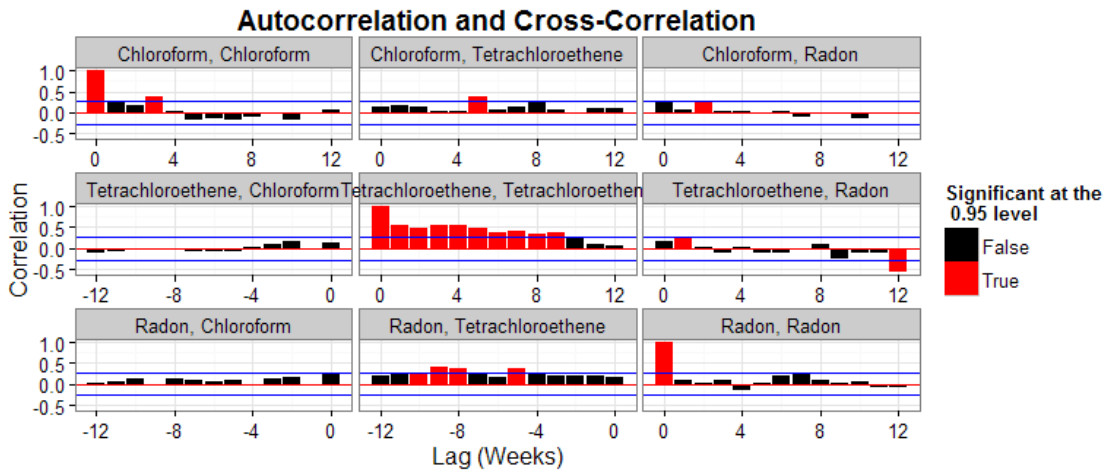
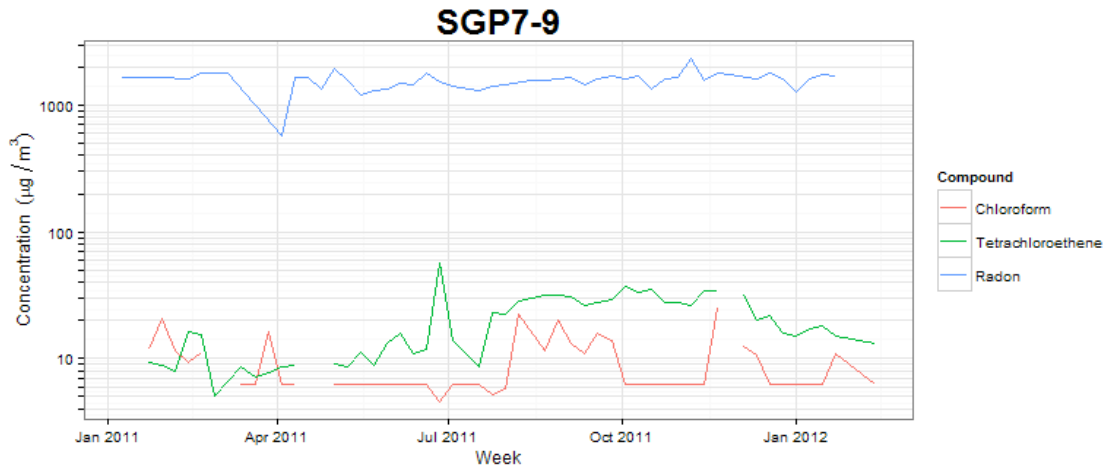

Figure 6-6. Temporal trends and cross-correlograms of chloroform (red), PCE (green), and radon (blue) for SGP7 at 9 ft bls.

Note that radon concentrations are plotted in pCi/L.

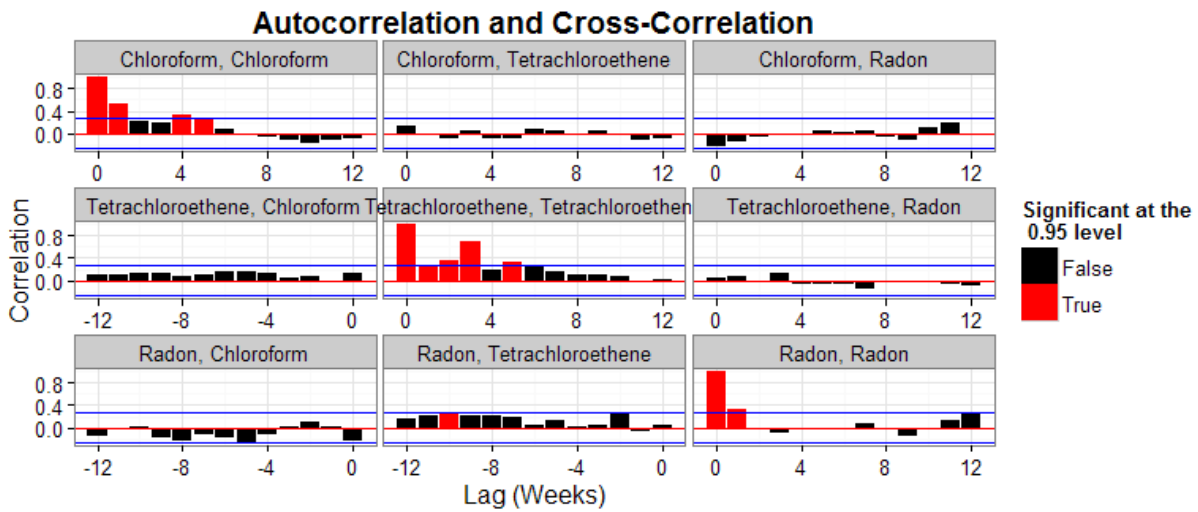
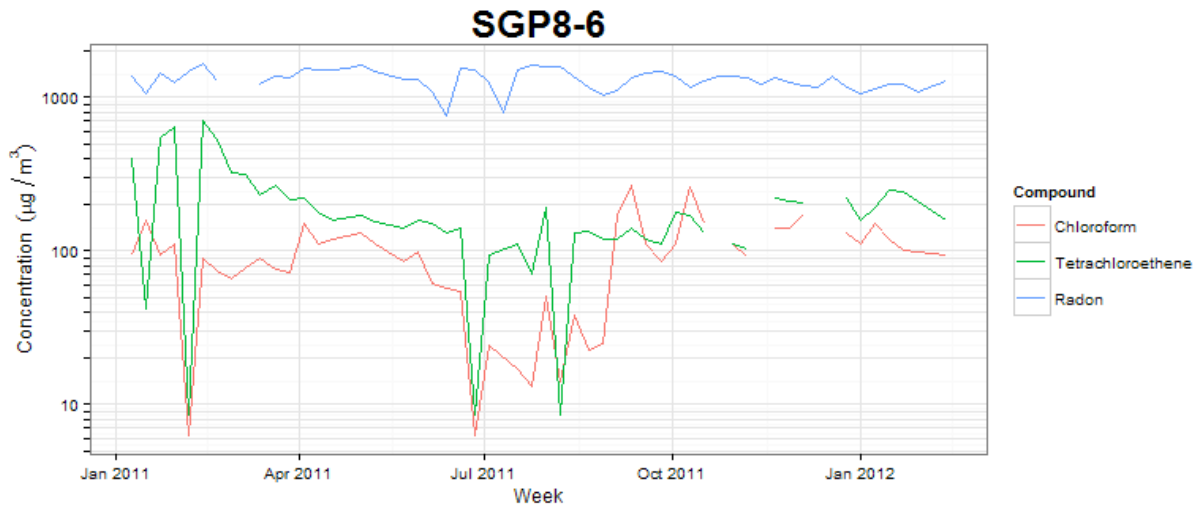

Figure 6-7. Temporal trends and cross-correlograms of chloroform (red), PCE (green), and radon (blue) for SGP8 at 6 ft bls.

Note that radon concentrations are plotted in pCi/L

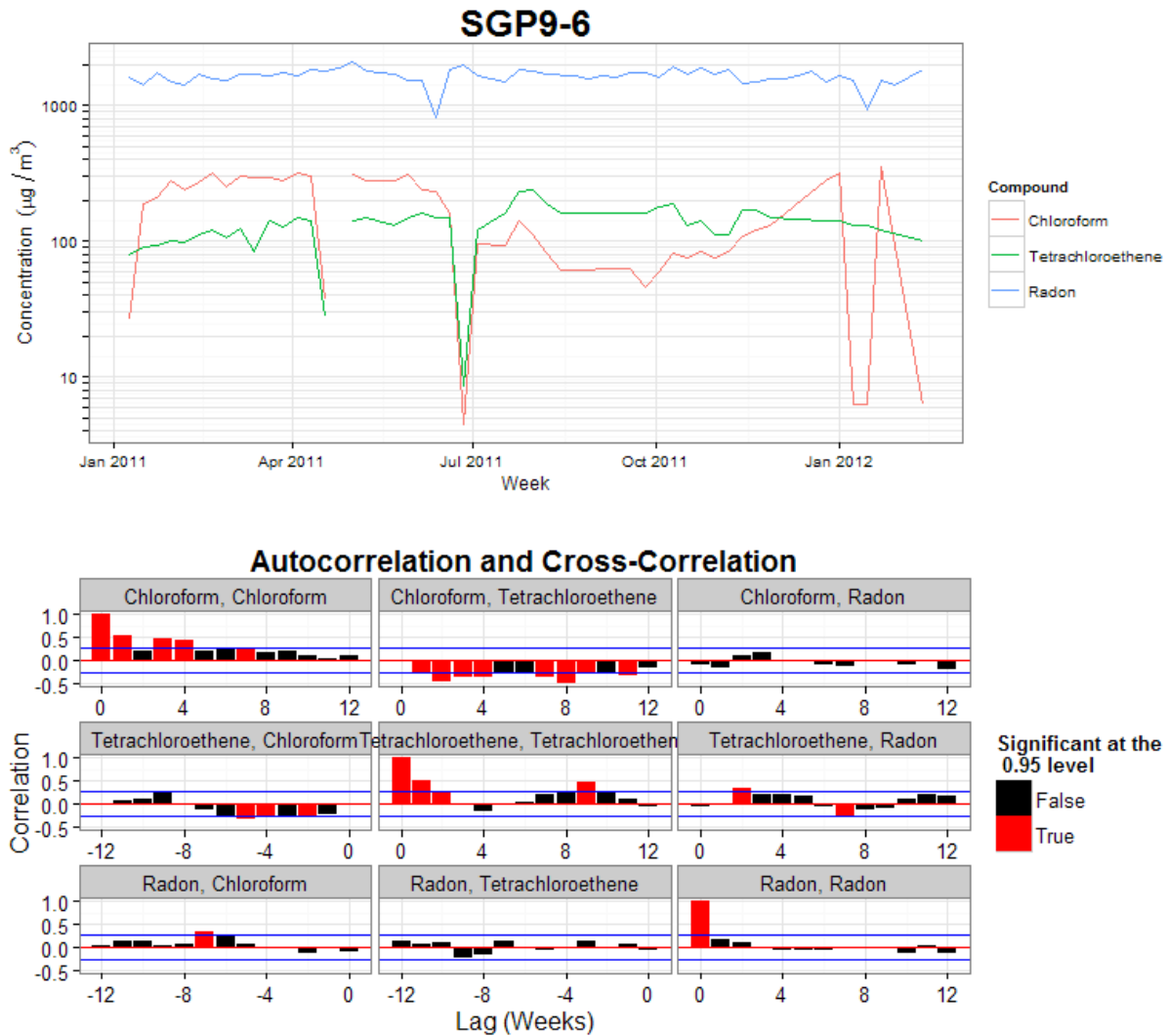

Figure 6-8. Temporal trends and cross-correlograms of chloroform (red), PCE (green), and radon (blue) for SGP9 at 6 ft bls.

Note that radon concentrations are plotted in pCi/L.

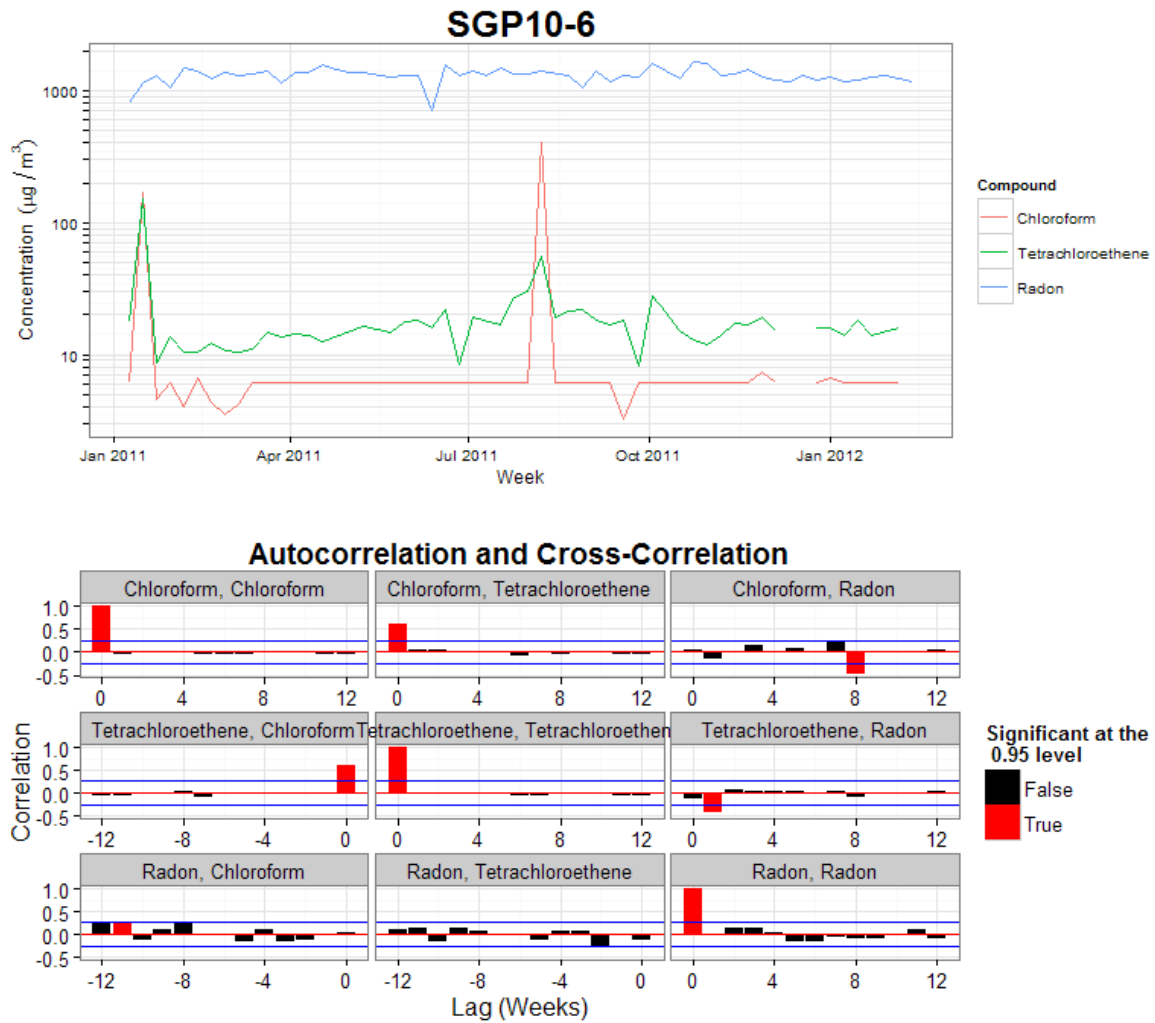

Figure 6-9. Temporal trends and cross-correlograms of chloroform (red), PCE (green), and radon (blue) for SGP10 at 6 ft bls.

Note that radon concentrations are plotted in pCi/L.

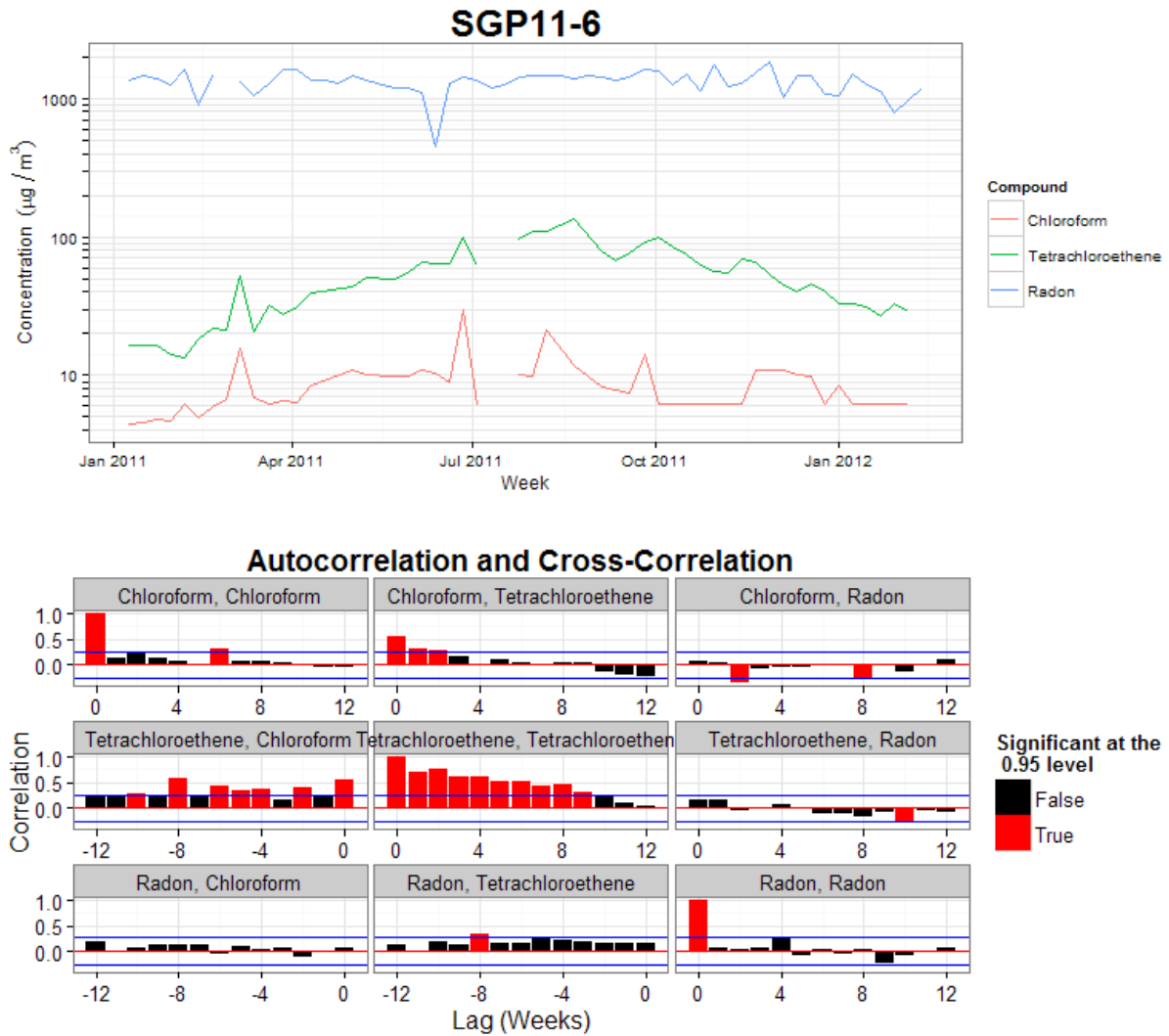

Figure 6-10. Temporal trends and cross-correlograms of chloroform (red), PCE (green), and radon (blue) for SGP11 at 6 ft bls.

Note that radon concentrations are plotted in pCi/L.

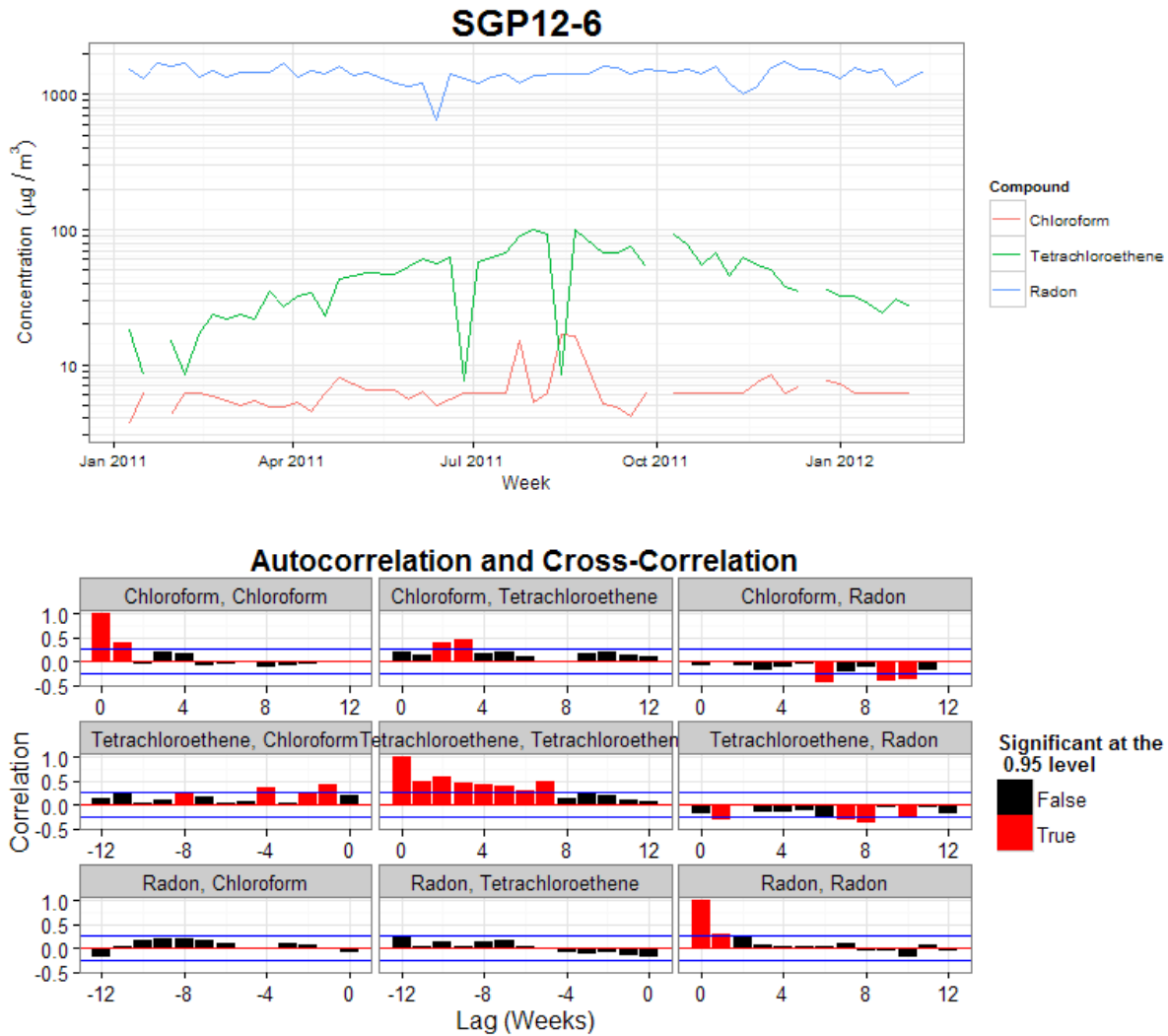

Figure 6-11. Temporal trends and cross-correlograms of chloroform (red), PCE (green), and radon (blue) for SGP12 at 6 ft bls.

Note that radon concentrations are plotted in pCi/L.

Cross-correlograms for chloroform and PCE with radon at SGP4 at 9 and 13 ft bls are shown in **Figures 6-3** and **6-4**. Only chloroform is positively correlated with radon at 9 ft at lags 4 and 5. At 13 ft, positive correlation was observed at lag 9 between PCE and radon; this particular cross-correlation might be the result of some noise or induced by the autocorrelation observed in both VOCs and radon. There is no obvious physical mechanism that could lead to a lag this long.

Both VOCs were positively and negatively correlated with radon at lag 6 and lag 0 with chloroform and PCE at SGP5 at 9 ft bls, respectively (**Figure 6-5**). Both VOCs and radon show autocorrelation at 0 and other lags; presence of autocorrelations might affect the cross-correlation with radon.

Radon was correlated with PCE at lag 1 and chloroform at lag 2 at SGP7 at 9 ft bls (**Figure 6-6**). However, the presence of autocorrelation observed in both VOCs and radon suggests that more in-depth analysis is needed to try to eliminate the autocorrelation in order to better assess the cross-correlation.

No correlation with radon was observed at SGP8 at 6 ft bls (**Figure 6-7**). Autocorrelation was observed in both VOCs and radon. Only PCE was negatively correlated with radon at SGP9 at 6 ft bls at lags 2 and 7 (**Figure 6-8**).

For SGP10 at 6 ft bls, both VOCs have negative correlation with radon at lags 1 (PCE) and 8 (chloroform) (**Figure 6-9**). For SGP11 at 6 ft bls (**Figure 6-10**), both VOCs showed negative correlation with radon at lags 2, 8 (chloroform), and 10 (PCE). For SGP-12, both VOCs showed negative correlation with radon at 6 ft bls at lags larger than 6 (**Figure 6-11**).

To summarize, from a practitioners perspective, the lack of a consistent, positive correlation between radon and VOCs in soil gas at a consistent lag time suggests that monitoring radon in soil gas would not be a practical tool for predicting variations of VOCs in soil gas.

6.2 Correlation between the Indoor Air Concentration and Radon

Figure 6-12 shows cross-correlation plots for the time series of log-VOCs and radon by indoor air location. Cross-correlations at different lags exceed the confidence bands, suggesting that VOCs are positively correlated with radon for all of the locations and that chloroform appears to have a stronger positive correlation (larger cross-correlation coefficients) with radon than PCE in the study house. Further analyses are needed to empirically model the relationship between the VOCs and radon, but these results do indicate that there is a statistically significant relationship between radon and the VOC concentrations. Developing such a model will allow us to describe what proportion of the temporal variability in VOCs can be predicted using radon, which is desirable because the cost of measuring radon is lower than the cost for measuring VOCs. From a practitioners perspective these results suggest that monitoring radon in indoor air could provide a helpful indication of the direction in which VOC concentrations in indoor air are moving.

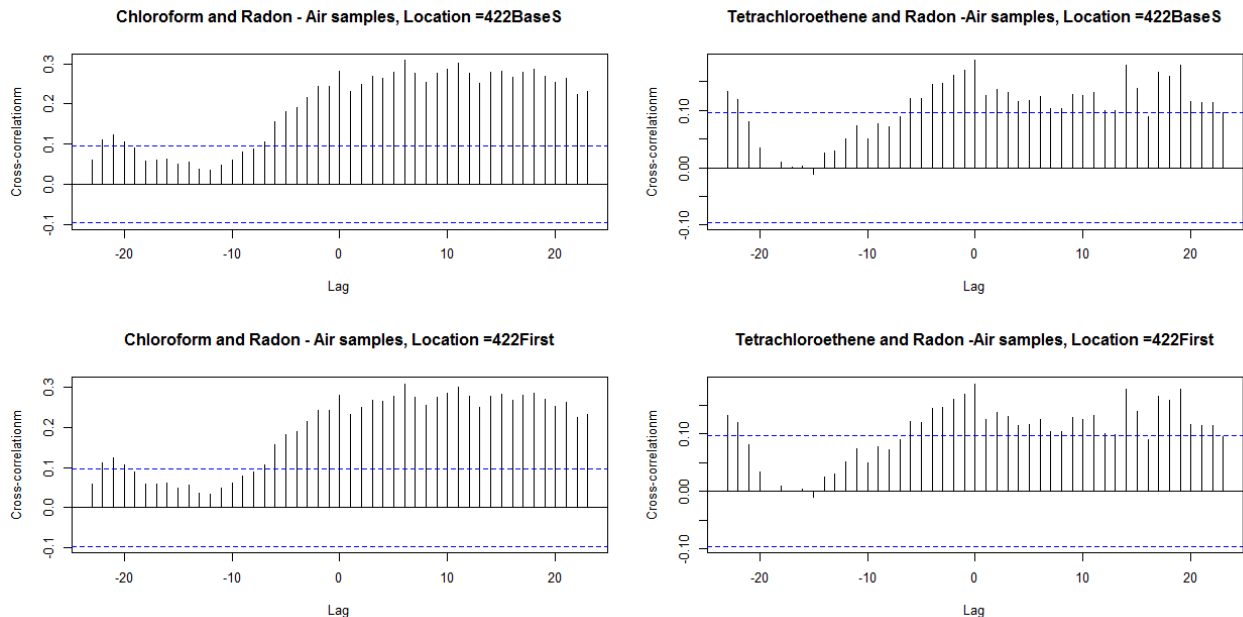

Figure 6-12. Cross-correlation plots for the time series of log-VOCs and radon by indoor air location.

6.3 Radon and VOC Soil Gas Spatial Distributions

The study design for this project in many cases nearly collocated conventionally installed subslab ports (in which the drill bit passes through the slab and 3 inches or less into the soil) with the upper intervals of multidepth interior soil gas monitoring points, which were installed as 6-inch stainless steel mesh screens starting immediately below the floor. Conceptually, we expect that a shrinkage crack or other gap directly beneath the slab will have more influence on the subslab ports than the wider screened soil gas ports.

In some instances, there appeared to be significant differences in the concentrations observed at these two very similar depth intervals and the shape of the temporal trends, as shown in **Figure 6-13**. These graphs present the concentrations over the course of the year of data with locally weighted scatterplot smoothing (LOWESS) applied (Cleveland, 1981; Cleveland and Devlin, 1988) and 95% confidence intervals shown for both locations. LOWESS makes the lines look neater while overlooking the issue of the different sample size available at different times. Interpretation of these plots should be made with caution given the different precision achieved at each lag. The confidence bands around the smoothed line are a function of the amount of data and the variability in the data. Smaller sample sizes and larger variability result in wider confidence intervals. Except for radon, overlap of the confidence bands suggests no difference between SGP and SSP locations. Formal testing should be used to statistically confirm whether the distribution of the analytes in the subslab ports (SSPs) is the same as the corresponding distribution of the shallow internal soil gas ports (SGPs).

The Kolmogorov-Smirnov (K-S) goodness of fit test was used to compare the significance of the distributions of the nearly collocated SSP and shallow internal SGP data. K-S is a nonparametric test for assessing whether two groups of data come from the same distribution. **Figure 6-14** shows the distributions and the results of the K-S tests. Results for TCE are not very robust given the high number of nondetects for that analyte. For all comparisons between SSP and SGP, the K-S tests resulted in significant p-values for radon suggesting that the SSP and SGP data come from different distributions. The distributions of the VOCs and radon data collected from SSP4 and SGP9 showed a difference that will be investigated in future work.

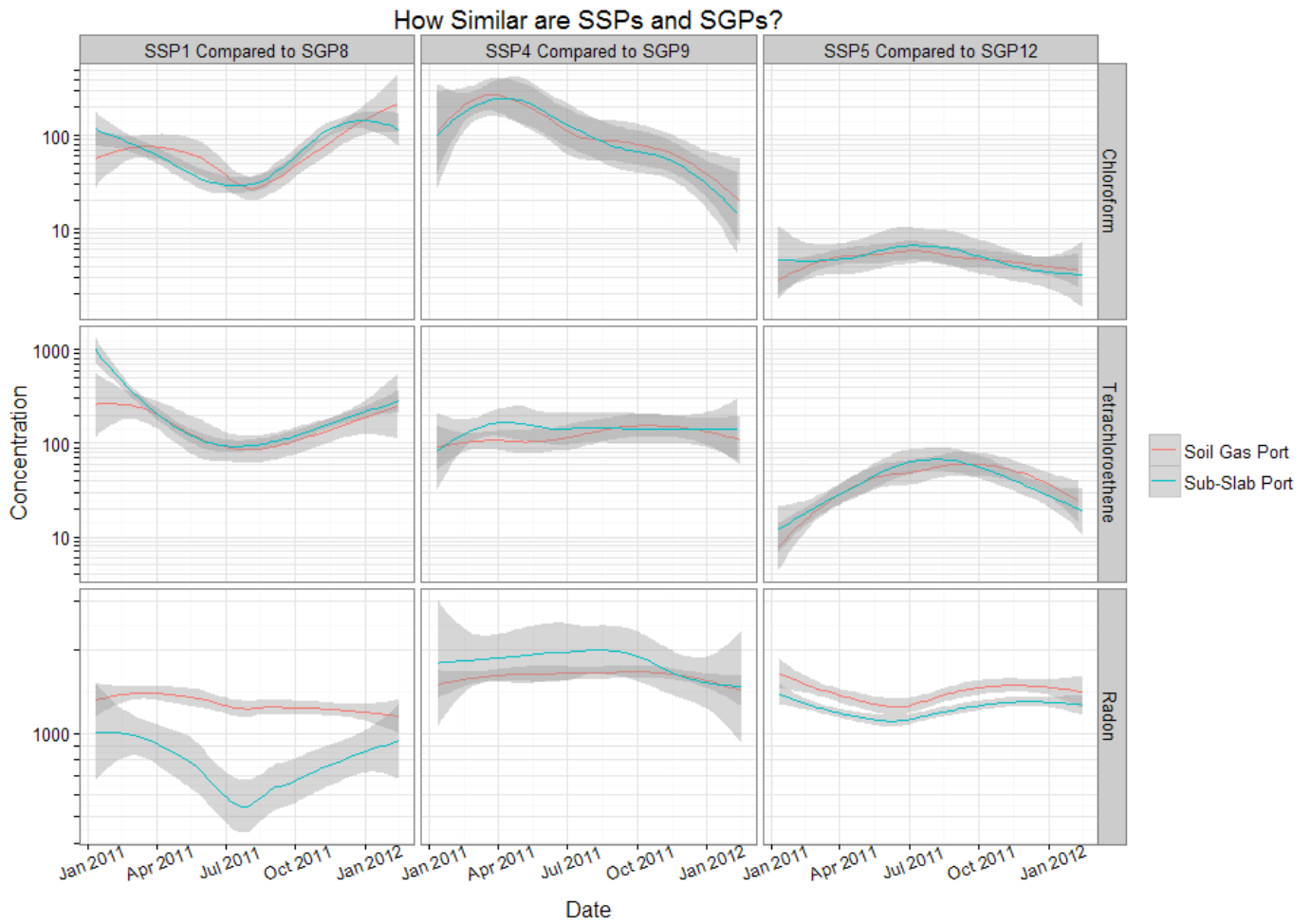

Figure 6-13. Comparison of nearly collocated subslab and shallow internal soil gas ports.

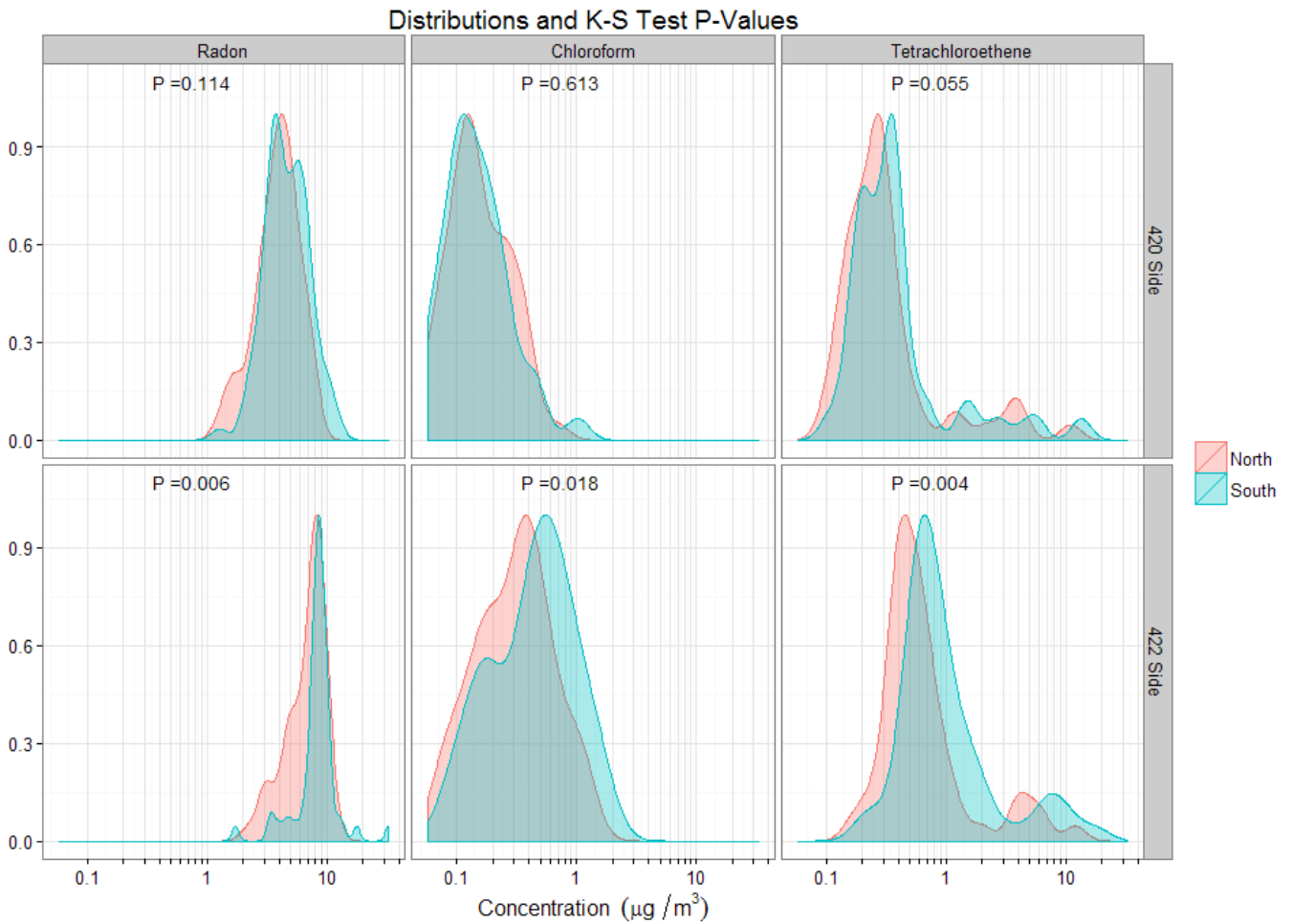

Figure 6-14. Concentration distributions ($\mu\text{g}/\text{m}^3$ [VOCs] or pCi/L [radon]) and significance tests for nearly collocated subslab and shallow internal soil gas ports.

6.4 Spatial Correlations in Radon and VOCs Analyzed Separately

Although we expected the basements on each side of the duplex to comprise a single HVAC zone after visual inspection, they may have different entry points for soil gas and fresh air. They also may not be well mixed between compartments. Therefore, we sampled at two locations within each basement and used the K-S test to compare the distribution of measured concentrations between sites located at the north and south ends of the basements. If the data provide evidence against the null hypothesis that the two distributions were not different, we could then merge the north and south sampling point concentrations for future analysis. Significant differences in the two distributions were found between the north and south for PCE and radon on the 422 side of the house (Figures 6-15 and 6-16) for all compounds, suggesting that in this side of the house other factors may be affecting the observed outcomes of the analytes.

The cross-correlations between the north and south sampling locations within each basement were also examined (Figure 6-17). For chloroform and PCE, a positive correlation exists between the two sides of the house. In contrast, the distribution of the north and south sides at different sides of the house have positive and negative correlations, suggesting that other external factors result in high concentrations in

one side when the other side is low, and vice versa. Further analysis should be performed to determine if these effects that influence the distribution of the radon can be determined and quantified.

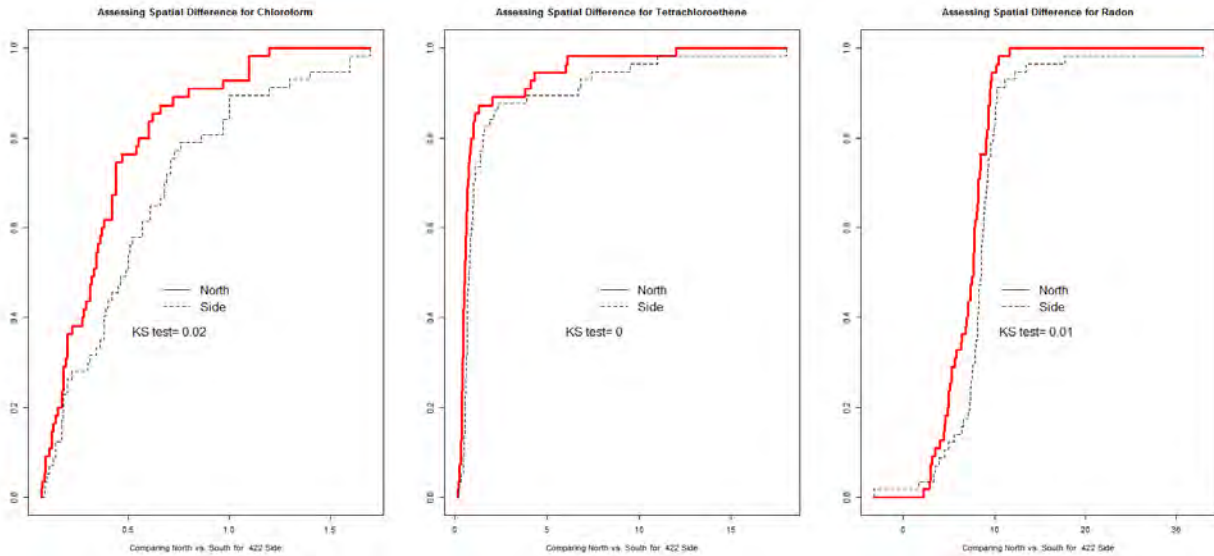

Figure 6-15. Evaluation of spatial effect north and south basement by VOC and radon for 422 East 28th St.—cumulative distribution plots where the x axis represents concentration ($\mu\text{g}/\text{m}^3$ or pCi/L) and the y-axis concentration.

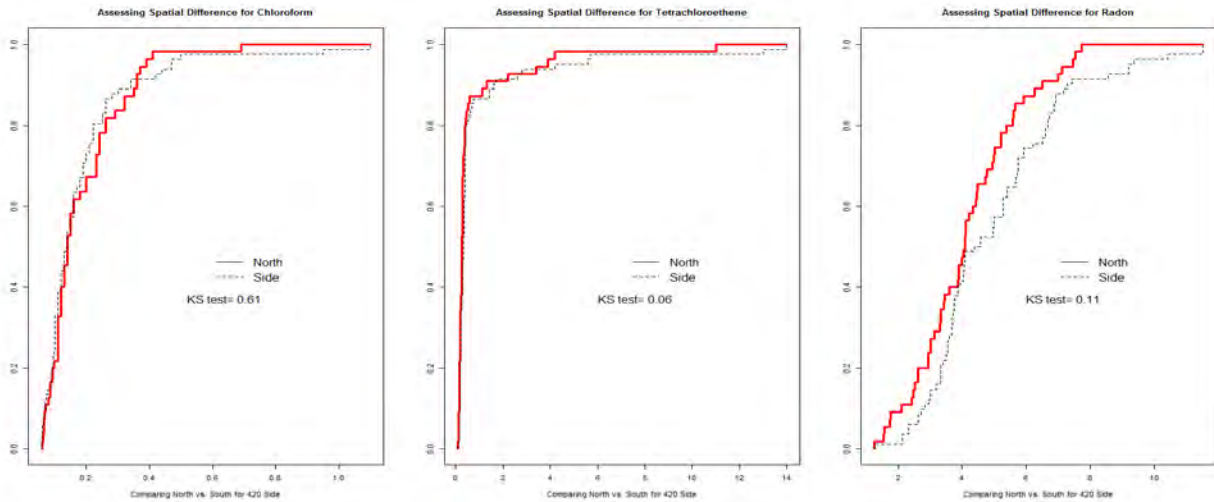

Figure 6-16. Evaluation of spatial effect north and south basement by VOC and radon for 420 East 28th Street—cumulative distribution plots where the x axis represents concentration ($\mu\text{g}/\text{m}^3$ or pCi/L) and the y-axis concentration.

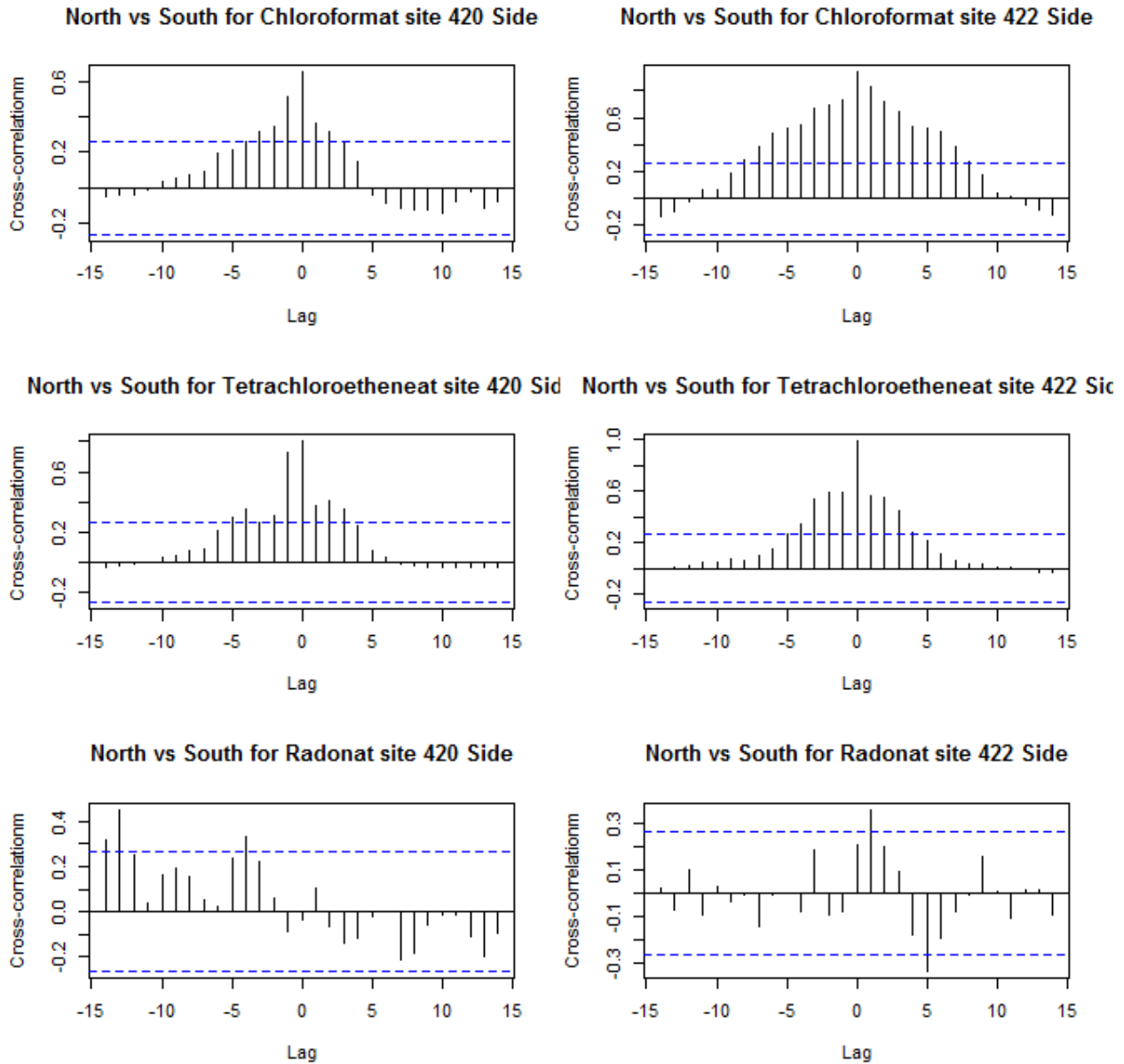

Figure 6-17. Cross-correlation between north and south basement indoor air by VOCs and radon.

In **Figure 6-18**, the temporal trends on the north and south sides of the basement are visualized. These graphs present the concentrations over the course of the year of data with a smoother curve depicting the temporal trend and 95% confidence bands for both locations and radon and VOCs. As mentioned earlier, the smoother makes the lines look neater, and it takes into account the issue of different sample size at different times and locations. The confidence bands around the smoothed line are affected by the sample size and the variability in the data.

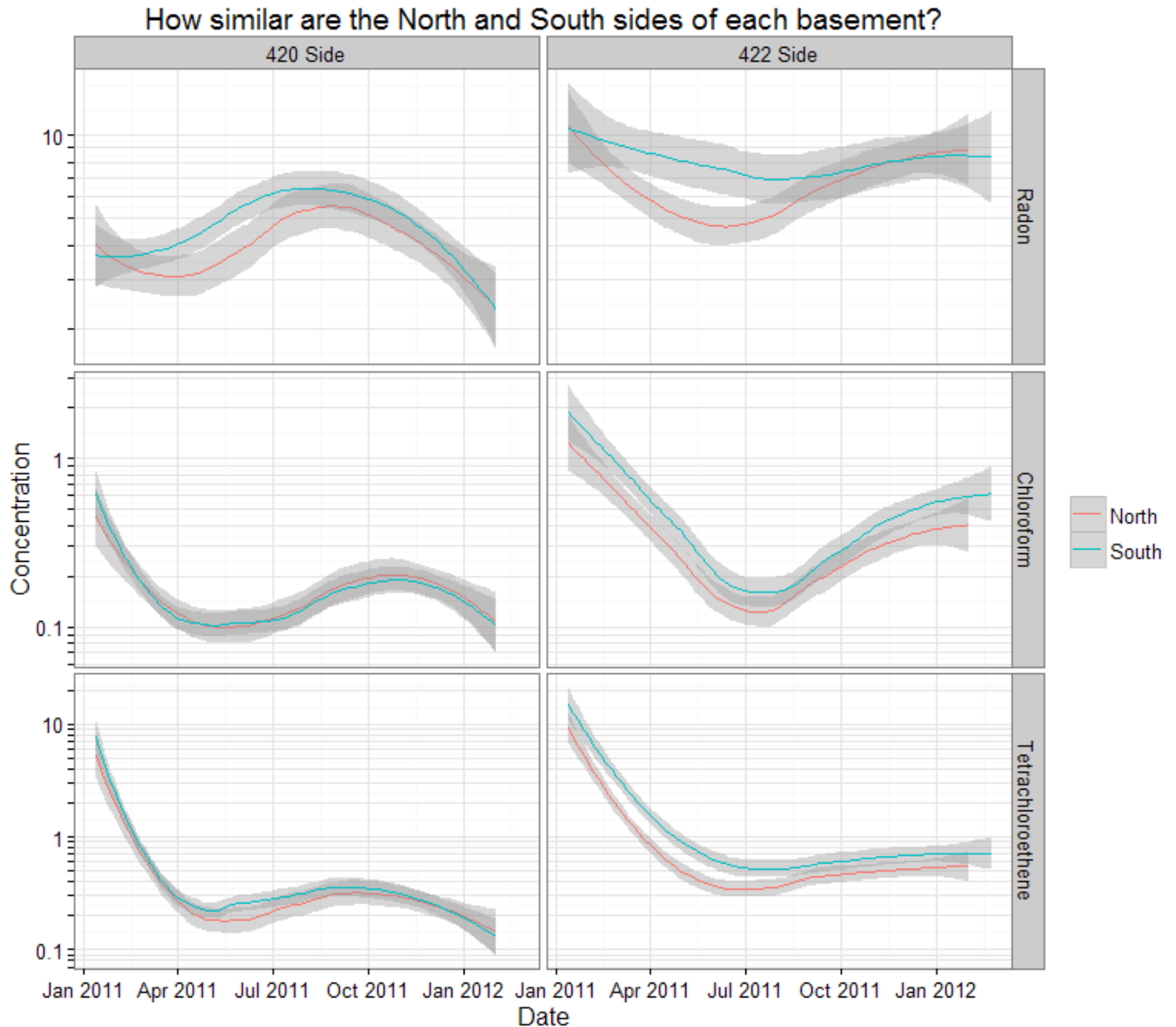

Figure 6-18. Comparison of temporal trends at north and south basement sampling locations.

Although it appears that the south side of the 422 basement produces consistently higher concentrations for the vapor intrusion-related constituents (PCE, chloroform, and radon), the overlapping of the confidence bands suggests that the temporal trends have similar distributions at each location (**Figure 6-18**). Formal testing (K-S test) is needed to determine quantitatively whether the data from the north and south have the same distribution. Thus, the indoor air concentration distribution somewhat reflects the subslab distribution in that the VOC concentrations at the northern ports SGP10-6 and SSP-2 are typically an order of magnitude or more lower than the central and southern ports beneath the 422 duplex (see Section 5.1 for VOC data). Interestingly, the difference between northern, central, and southern soil gas ports is much less marked for radon (see Section 5.2). However, when expressed as year-long mean or median concentrations (**Table 6-3**), the differences between the northern and southern locations, although statistically significant, are unlikely to be large enough to lead to differing management decisions under these site conditions.

Table 6-3. Comparison of Mean and Median Concentrations in North and South Sampling Locations, 422 Side of Duplex

Compound	Location	Mean (pCi/L or $\mu\text{g}/\text{m}^3$)	Median (pCi/L or $\mu\text{g}/\text{m}^3$)
Radon	North	5.60	5.19
Radon	South	6.47	6.22
Benzene	North	0.78	0.70
Benzene	South	0.78	0.72
Chloroform	North	0.29	0.20
Chloroform	South	0.34	0.19
Hexane	North	0.64	0.52
Hexane	South	0.67	0.55
Tetrachloroethene	North	0.94	0.38
Tetrachloroethene	South	1.30	0.43
Toluene	North	1.71	1.40
Toluene	South	1.70	1.40
Trichloroethene	North	0.11	0.05
Trichloroethene	South	0.14	0.05

6.5 Correlations in Indoor Air VOC and Radon Temporal Trends

The autocorrelation function (ACF) is a collection of correlation coefficients between the series and lags of itself over time. If the ACF plot is contained within the blue dashed lines, there is no temporal correlation and the observations can be considered independent. **Figure 6-19** displays the ACF for each VOC and radon. All ACF plots show spikes exceeding the confidence bands suggesting a temporal correlation and that the measurements are not independent. The nonindependence of the data suggests that standard tests cannot be applied to the data without previously removing the temporal trend. Applying standard tests to correlated data may result in under-estimated standard errors and larger p-values, which will increase the likelihood of not rejecting a hypothesis of difference.

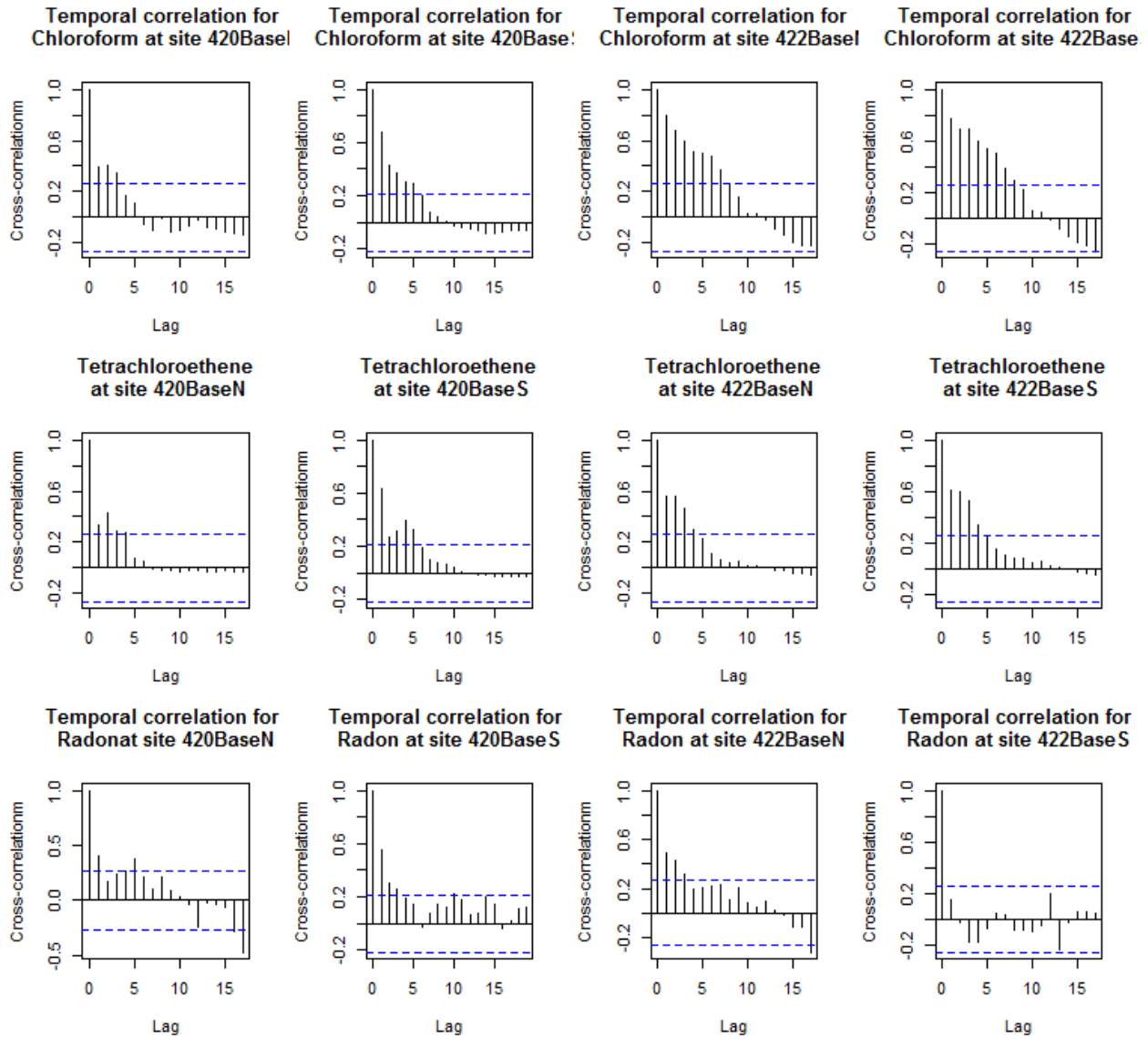

Figure 6-19. Autocorrelation function for chloroform, PCE, and radon by location (site and north/south basement).

Table of Contents

7.	Results and Discussion: Attenuation of Soil Gas VOCs and Radon.....	7-1
7.1	Subslab to Indoor Air Attenuation Factor Temporal Range.....	7-1
7.2	Subslab Attenuation Factors for Each Side of the Duplex	7-3
7.3	Attenuation Factors Calculated for Each Side of the Duplex Using Subslab and Shallow Soil Gas Samples.....	7-6

List of Figures

7-1.	Subslab (or 9-ft soil gas) to indoor air AFs for individual sample locations, with the number of calculated AFs in each case indicated by the number directly below each whisker.	7-2
7-2.	Subslab to indoor air attenuation factors, calculated for each side of the duplex using only subslab points.	7-4
7-3.	Range of weekly chloroform and PCE concentrations in indoor air, subslab, and 9-ft interior soil gas samples over study period, with the number of calculated AFs in each case indicated below the whiskers.	7-5
7-4.	Attenuation factors vs. time: calculated for each side of the duplex using subslab soil gas ports and the shallowest of the nested interior soil gas ports.	7-7

7. Results and Discussion: Attenuation of Soil Gas VOCs and Radon

In this section we explore the relationship between radon and VOC levels in indoor air and concentrations measured in subslab and deeper soil gas, which is usually portrayed through the vapor intrusion attenuation factor (AF). As described in Section 2.1.2, the vapor intrusion AF is the indoor air concentration divided by a subsurface soil gas concentration at the same time and location. For example, if subslab soil gas concentrations are 100 times the indoor air concentration measured at the same time, the subslab AF would be 0.01. This section focuses on a general comparison of subslab and deeper soil gas AFs for the entire project. Additional analysis of seasonal, weekly, and daily trends and relationships will be accomplished in the next phase of this project.

7.1 Subslab to Indoor Air Attenuation Factor Temporal Range

After confirming that the number of nondetectable results in the indoor air and soil gas datasets to be used was very small and, thus, not an issue, individual weekly AFs were calculated for PCE, radon, and chloroform¹ at each sampling location by sorting the data by location and week and then averaging all observations from the same week and location. For soil gas concentration (the AF denominator), the sample points for this analysis included all subslab soil gas points (SSP1 through SSP7) as well as the 9-ft deep soil gas probes installed within the building (SGP8 through SGP12). For indoor air, weekly measurements for the north and south basement of each side of the duplex were averaged to generate a single weekly indoor air concentration (the AF numerator) for each side of the duplex that was used to calculate AFs for all subslab or soil gas sample points on that side.

Results are presented as box and whisker plots in **Figure 7-1**. In these plots:

- Concentration ($\mu\text{g}/\text{m}^3$ for VOCs and pCi/L for radon) is plotted on a logarithmic axis.
- The median of the data is represented by a dark black horizontal line across the box.
- The 25% to 75% range of the distribution is represented by the box.
- The whiskers go to the last point before the outlier cutoff, which is ± 1.5 times the interquartile range (75th percentile-25th percentile) (R Development Core Team, 2012; Wickham, 2009).
- Individual outlying data points above or below the whiskers are plotted as dots.
- 420 AFs are plotted in red and 422 AFs are plotted in green.
- The number of AFs are included below each box and whiskers plot.

Because each box and whiskers plot provides the distributional statistics for a single subslab or deeper soil gas sampling point, the span of the plot represents the temporal variability of the AF at that point. Notable observations that can be made from **Figure 7-1** include:

- The inter-quartile range is generally quite narrow compared with other AF distributions that have been published. This can be attributed to the fact that each box and whiskers plot is fixed in space and, therefore, represents temporal variability in attenuation only. The high number of measurements made here enable us to conclude that for most of the year, the AF at a particular sample point is fairly stable. However, the full distribution is as wide as two orders of magnitude for PCE and chloroform, suggesting that any single sampling event could yield an AF far enough from the mean to markedly affect site management decisions.

¹ The number of nondetects was significant for other analytes (e.g., TCE, benzene, hexane, 1,1-DCE) measured in soil gas and indoor air. See Section 5.

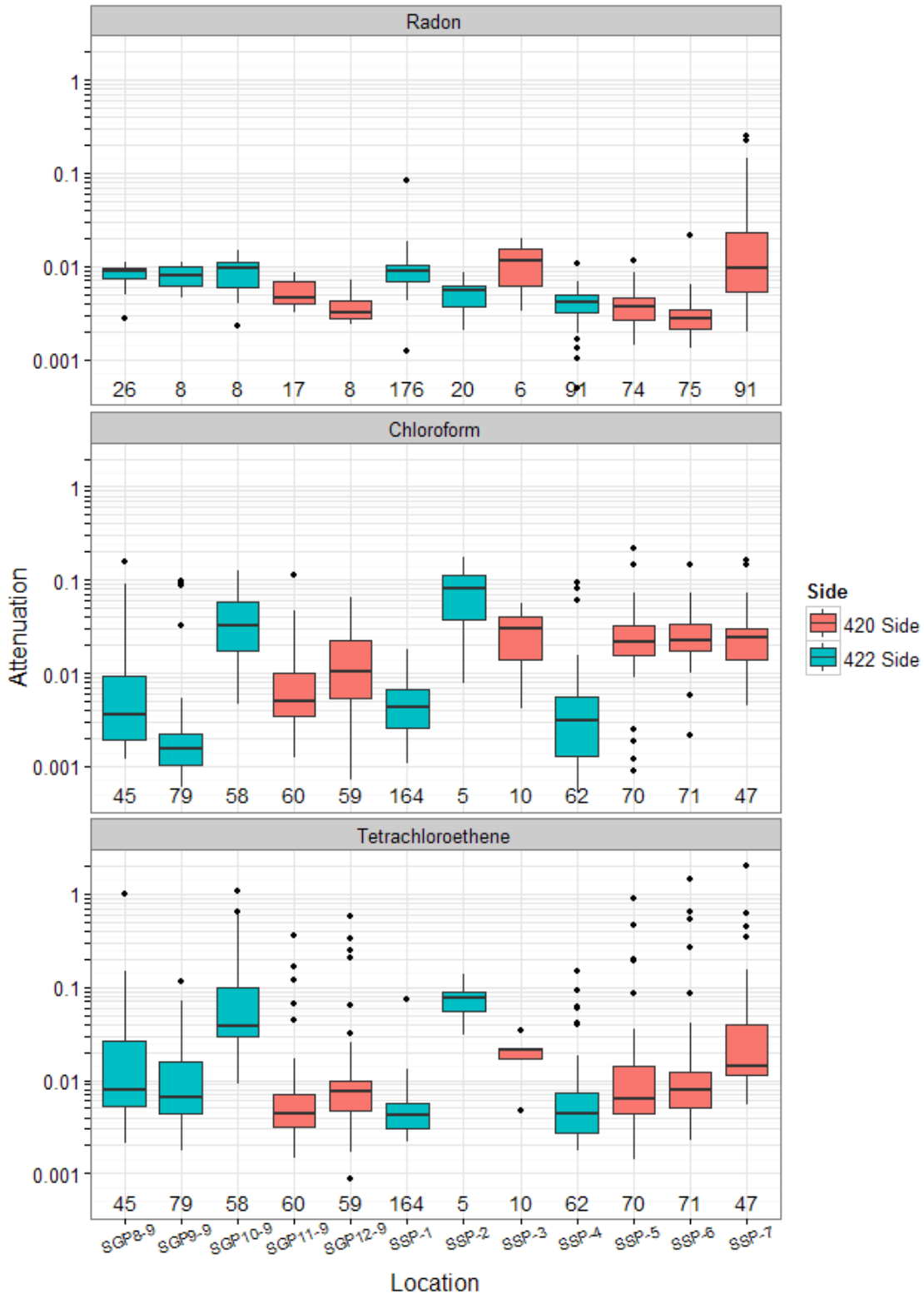

Figure 7-1. Subslab (or 9-ft soil gas) to indoor air AFs for individual sample locations, with the number of calculated AFs in each case indicated by the number directly below each whisker.

- There is considerably less variability in the measured radon AFs than for VOC AFs. The reason for this is not yet known, but the VOC and radon figures presented in Sections 5.1 and 5.2 (e.g., compare **Figures 5-5** [chloroform] and **5-7** [PCE] with **Figure 5-37** [radon] for subslab) suggest that there is much more stability in radon concentrations in the subslab and shallow soil gas than for VOCs. One reasonable explanation of this result is that the radon concentrations are expected to be controlled by the emanation rate characteristic of the soil immediately surrounding a probe and the rate of barometric (or stack effect induced) pumping (see Section 2). VOC concentrations are subject to all of those causes of variability as well as processes occurring in the deep subsurface along the longer VOC migration path from the source (e.g., water table fluctuations, temperature dependent processes). The short half-life of radon (3.8 days vs. a year or more for PCE) prevents subsurface migration being a significant influence on radon vapor intrusion as it is with VOCs. Because the radon source is primarily from the soils immediately surrounding a building, radon AFs may provide useful information about building envelope-specific processes.
- There appears to be reasonable agreement between the chloroform and PCE AFs on the 422 side of the duplex. The measures of central tendency of the chloroform AF distributions for the 420 side of the duplex tend to be somewhat higher than those for the 422 side.
- The variability in AFs for different sampling points is greater on the 422 side, with the 420 side having fairly consistent values from point to point for both subslab and the 9-ft deep soil gas probes. It is not known whether the greater variability on the 422 side is due to the influence of the heating system installed on that side or to differences in subsurface characteristics. Geophysical tests just completed at the site for the follow-on project may provide insights on the latter hypothesis.
- Although the subslab samples would be expected to have higher AFs (i.e., lower attenuation) than the deeper (9-ft) soil gas, differences in AFs for the subslab vs. 9-ft soil gas are not markedly apparent from visual observations.

These conclusions are based on observation of **Figure 7-1**, other lines of evidence from this study, and general knowledge of vapor intrusion processes. Additional statistical analyses will be required to determine which observations are statistically significant and which are not.

7.2 Subslab Attenuation Factors for Each Side of the Duplex

In **Figure 7-2**, we plot the average attenuation within each basement (420 and 422) over the course of the study, calculated as follows:

$$420AvgAttenuation = Avg(420BaseS, 420BaseN) / Avg(SSP-3, SSP-5, SSP-6, SSP-7)$$

$$422AvgAttenuation = Avg(422BaseS, 422BaseN) / Avg(SSP-1, SSP-2, SSP-4).$$

In **Figure 7-2**, AFs appear to be much more variable on the unheated 420 side of the duplex. The heated 422 side of the duplex shows only two major “bumps” in the trend, one of which appears to correspond to the fan tests conducted in September and October 2011 (discussed in Section 12.2), and the other effects only chloroform at the very end of the study period.

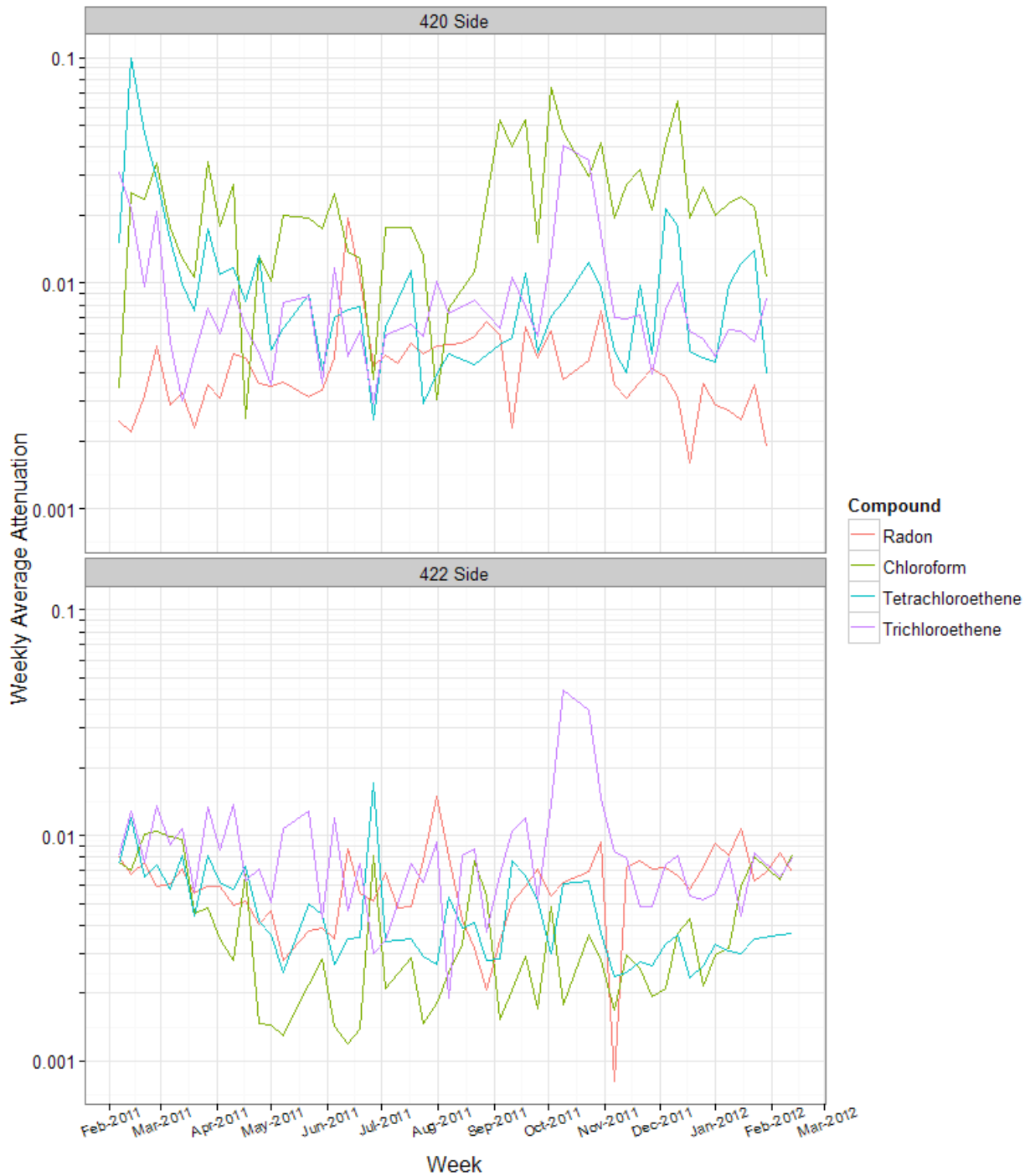

Figure 7-2. Subslab to indoor air attenuation factors, calculated for each side of the duplex using only subslab points.

It is also notable that for chloroform and PCE, the AF temporal series plots bear little resemblance to the indoor concentration plots presented in Section 5.1 (see **Figures 5-1** and **5-2**). This dissimilarity suggests that the variance of concentration in indoor air is driven more by variance in subslab or deeper soil gas concentrations (**Figure 7-3**) and less by changes in the building-specific AF across the slab. **Figure 7-2** also does not show an obvious correspondence between AFs for radon and the VOCs, suggesting that

different processes are controlling these contaminants. On the 422 side the radon AF generally agrees well with the PCE and chloroform AFs. That is not the case on the 420 side, where the apparent attenuation of VOCs is generally less than that for radon.

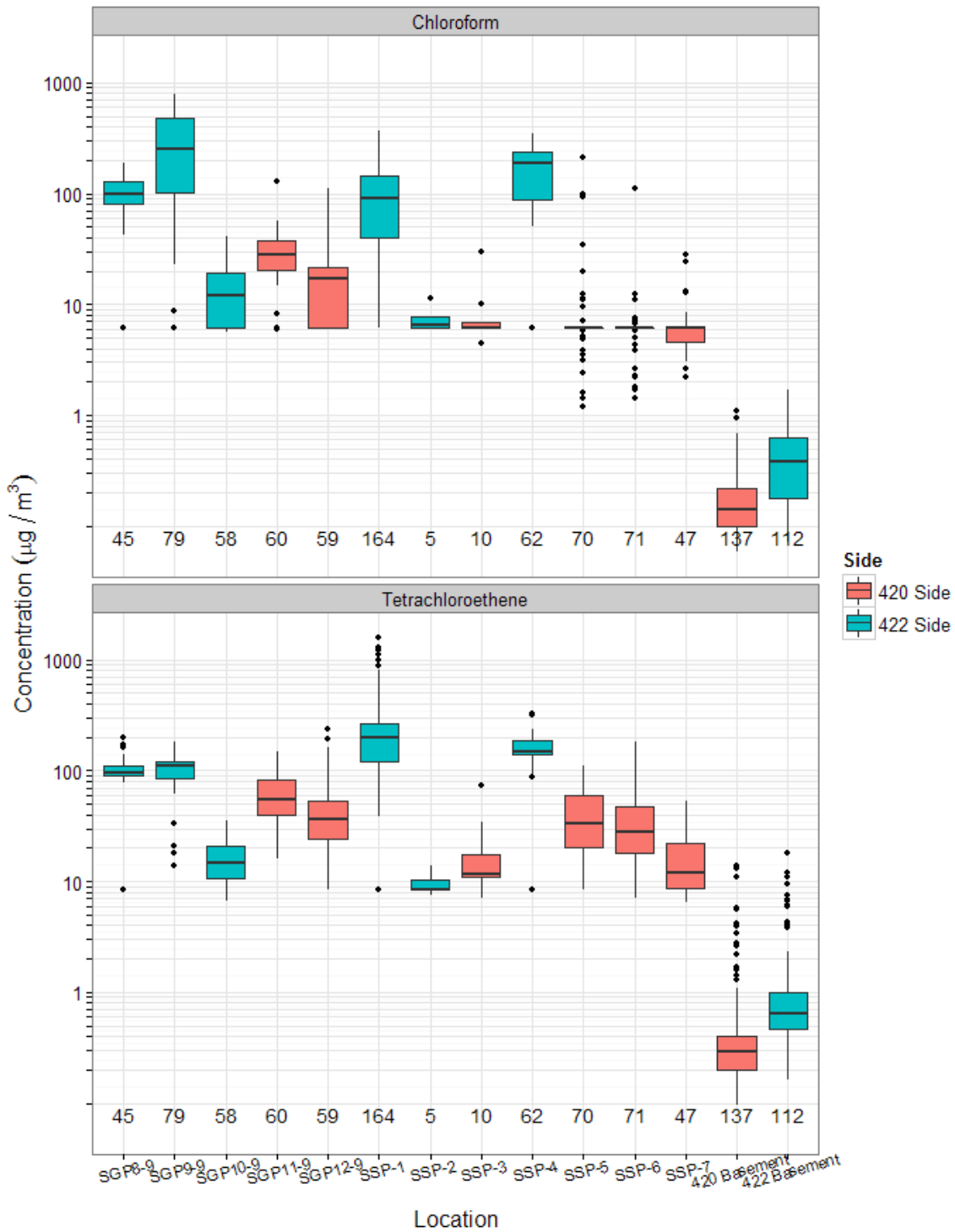

Figure 7-3. Range of weekly chloroform and PCE concentrations in indoor air, subslab, and 9-ft interior soil gas samples over study period, with the number of calculated AFs in each case indicated below the whiskers.

7.3 Attenuation Factors Calculated for Each Side of the Duplex Using Subslab and Shallow Soil Gas Samples

The AFs for this analysis were calculated for each side of the duplex using all available shallow soil gas, subslab soil gas, and indoor air measurements. The two different AFs were calculated as follows:

$$AF_{420SGBF} = \text{Avg}(420\text{BaseN}, 420\text{BaseS}) / \text{Avg}(SSP-3, SSP-5, SSP-6, SSP-77, SGP11-6, SGP12-6)$$

$$AF_{422SGBF} = \text{Avg}(422\text{BaseN}, 422\text{BaseS}) / \text{Avg}(SSP-1, SSP-2, SSP-4, SGP8-6, SGP9-6, SGP10-6)$$

The 422 side VOC AFs calculated in this way (**Figure 7-4**) show significant variance through the year, generally decreasing gradually from the start of the testing during the severe winter of January 2011 through July 2011. They then rise only modestly into the milder winter of 2012.

Several points in early September and early October stand out from the gradual temporal trends as anomalously high AFs. These show the influence of fan testing, in which a box fan was placed at the head of the stairs of the 422 side of the duplex withdrawing air from the basement. This would be the expected result of depressurization of the basement space. The concentration and differential pressure results of the fan tests are discussed in Section 12.2.

On the 422 side of the duplex, there appears to be fairly close agreement between the AFs for PCE and radon except for a brief period in the winter of 2011, and the chloroform AFs seem to be somewhat lower than the PCE or radon AFs. On the 420 side of the duplex, the chloroform AFs are generally higher (less attenuation) than those for PCE, which is on the high side of the radon AF distribution. On both sides of the duplex, the radon AFs show less temporal variability than the VOC AFs (**Figure 7-4**).

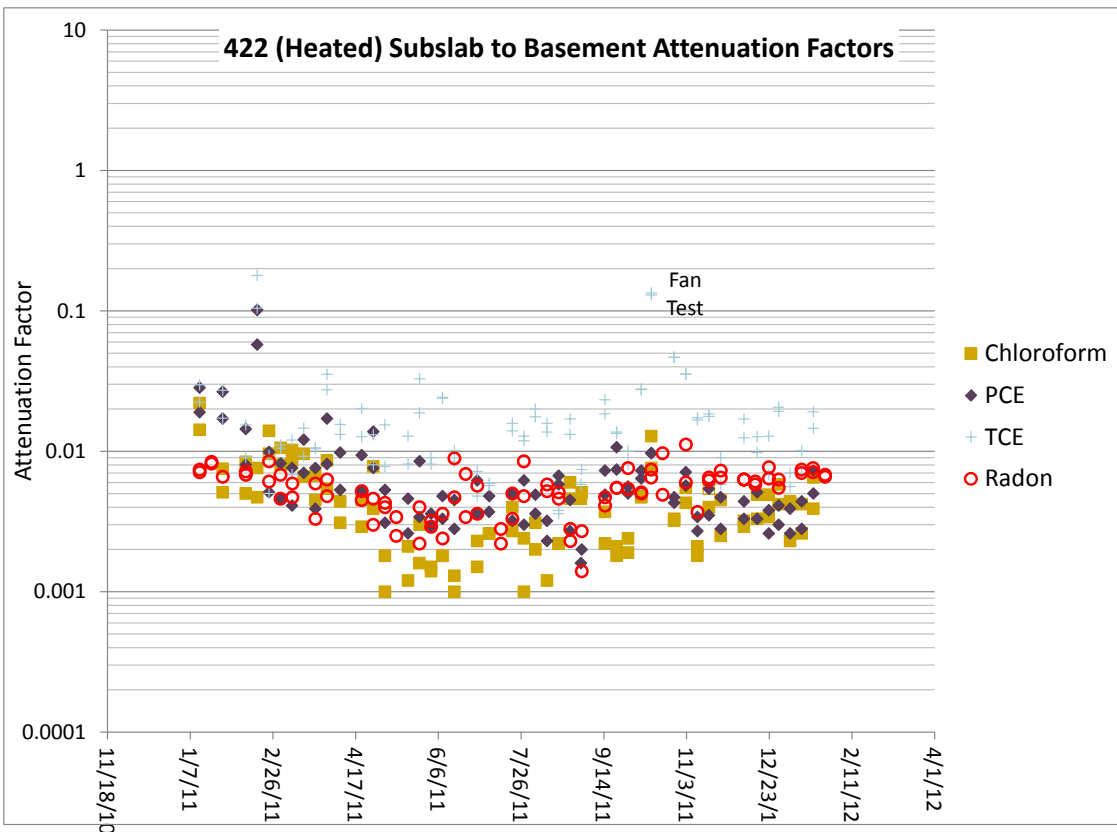
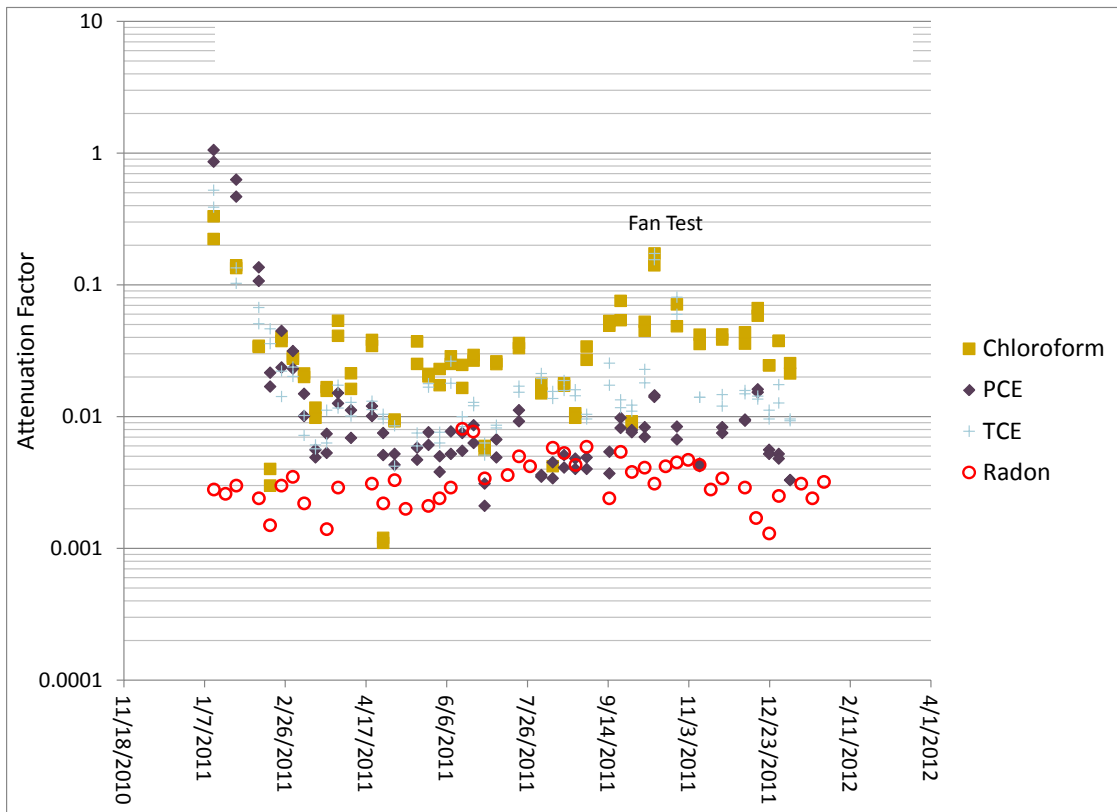

Figure 7-4. Attenuation factors vs. time: calculated for each side of the duplex using subslab soil gas ports and the shallowest of the nested interior soil gas ports.

Table of Contents

8. Results and Discussion: Can Near-Building External Samples Be Used as a Surrogate Sampling Location?.....	8-1
8.1 Comparison of External Soil Gas to Subslab Soil Gas.....	8-1
8.1.1 Chloroform.....	8-1
8.1.2 Tetrachloroethylene (PCE).....	8-2
8.1.3 TCE.....	8-3
8.1.4 Radon.....	8-4
8.2 Comparison of Wall Ports to Subslab External Soil Gas.....	8-5

List of Figures

8-1. Box and whisker plots of chloroform distribution in soil gas at varying depths (concentration is log scale).	8-2
8-2. Box and whisker plots of PCE distribution at various depths.....	8-3
8-3. Box and whisker plots of TCE distribution at various depths.	8-4
8-4. Box and whisker plots of radon concentration at various depths.....	8-5

8. Results and Discussion: Can Near-Building External Samples Be Used as a Surrogate Sampling Location?

The conventional assumption in the vapor intrusion field and in regulatory guidance documents is that subslab concentrations represent the best descriptor of a subsurface vapor intrusion source of the commonly collected lines of evidence. Although that assumption has been recently challenged by those who emphasize the potential for buildings to also contribute soil gas into the subslab space because of building overpressurization (e.g., McHugh et al., 2006), it will be taken as a given for the purposes of this chapter.

Because subslab samples are generally considered by vapor intrusion investigators to be more intrusive on the lives of residents than exterior samples, some practitioners and responsible parties strongly desire to make maximum use of exterior soil gas as a line of evidence before resorting to subslab sampling inside the house. Exterior soil gas points are often installed within 10 horizontal ft of the foundation edge, as was done in this study. Some regulatory agencies (e.g., some California agencies) have suggested multidepth exterior soil gas as a useful line of evidence and prefer deep to shallow soil gas as a conservative/definitive estimate of concentrations under the building slab. The construction of multidepth soil gas ports extending vertically below the interior of the building is, however, rare outside of research studies. Thus, we compare the trends of concentration versus depth for the multidepth soil gas points installed in the exterior and interior of the house and compare those with the subslab concentrations.

In order to examine these trends, the soil gas data for all time points sampled were used to prepare a series of box and whisker plots for subslab and interior, and exterior soil gas samples at different depths. In these plots:

- Concentration ($\mu\text{g}/\text{m}^3$) is plotted on a logarithmic axis.
- The median of the data is represented by a dark black line.
- The 25% to 75% range of the distribution is represented by the box.
- The whiskers go to the last point before the outlier cutoff, which is ± 1.5 times the interquartile range (75th percentile-25th percentile) (R Development Core Team, 2012; Wickham, 2009).
- Individual outlying data points are plotted as dots.

In these plots, the exterior soil gas points at each depth are grouped as a population (orange boxes), and the interior soil gas points at each depth are grouped as another population (blue boxes). The range of results for these many samples (over 60 points sampled weekly for over 50 weeks) illustrates the potential variability that could result with the much fewer data points that are taken during a more typical vapor intrusion investigation. Because it is so extensive, this dataset can be used to model decisions that would result if few samples are taken, inside or outside the study building or at different times during the year.

In reviewing these box plots, the reader should keep in mind that the subslab samples in this study duplex are beneath the basement and approximately 5 ft bls. The percentages of nondetects for the data that went into these plots are tabulated by compound and depth in Tables 5-1 and 5-2 in Section 5.1.3.

8.1 Comparison of External Soil Gas to Subslab Soil Gas

8.1.1 Chloroform

Chloroform mean concentrations increase with depth (**Figure 8-1**). The highest median concentrations are associated with the samples collected just above the water table: 13 or 16.5 ft (note that the 16.5-ft depth could not be sampled for soil gas at many times because the water table rose above that depth). This

suggests a groundwater source or transport pathway for chloroform in the vicinity of the house. The median concentration decreases nearly two orders of magnitude with depth, which suggests considerable natural attenuation. Although the mechanisms for this attenuation are not known and can include dilution/barometric pumping, chloroform is also subject to biodegradation both by anaerobic organisms and cometabolically under aerobic conditions (AFCEE, 2004). This attenuation is so dramatic that by the 3.5-ft depth most of the observations are nondetects. Thus, the 3.5-ft exterior soil gas would not have predicted the subslab concentration well. The interquartile range for chloroform in subslab (approximately 5 ft) is quite similar to the interquartile range at 6 ft for exterior and interior soil gas. The subslab concentration median is, however, considerably higher. The median chloroform concentration in subslab soil gas lies between the median concentrations in exterior soil gas at 9 to 13 ft.

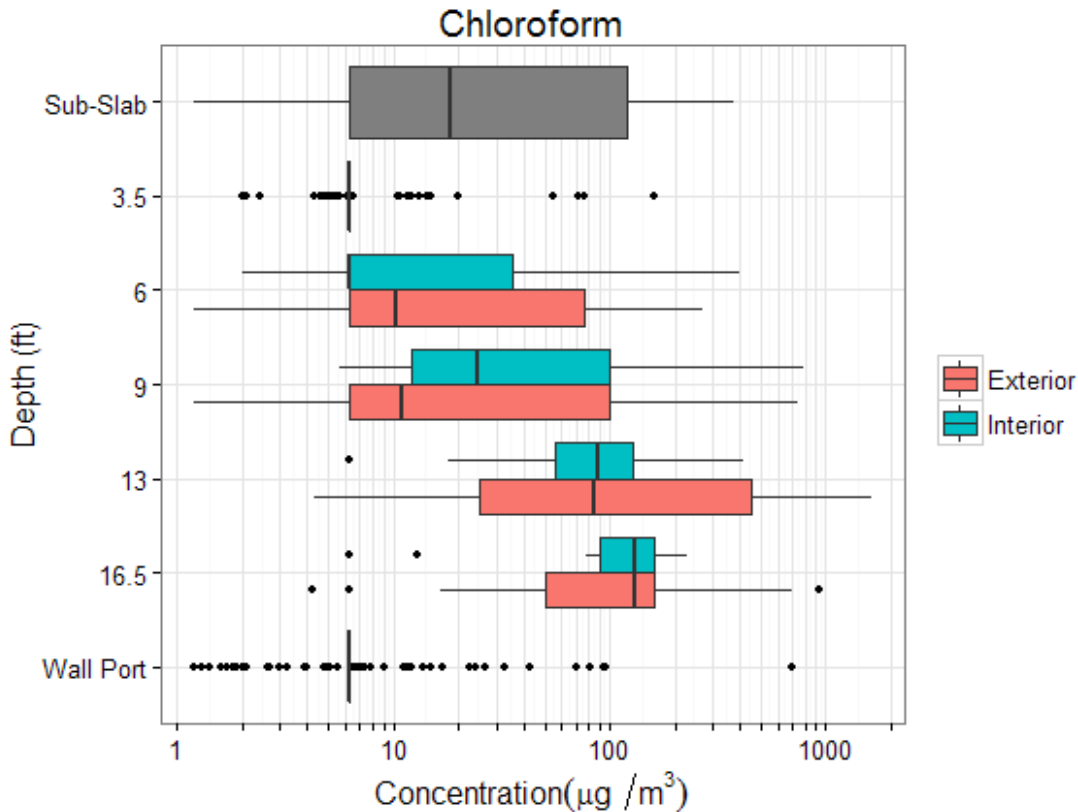

Figure 8-1. Box and whisker plots of chloroform distribution in soil gas at varying depths (concentration is log scale).

The interquartile range of the chloroform data is consistently wider for exterior than for interior soil gas sample locations. Because the spatial span of the exterior locations is greater than the interior locations, this is not necessarily a function of the capping effect of the building but could reflect subsurface heterogeneities that are more apparent at the greater spatial scale.

8.1.2 Tetrachloroethylene (PCE)

The median PCE concentration is highest in the 16.5 ft and subslab depths (Figure 8-2). There is only a slight indication of attenuation with depth if the median concentrations at 16.5, 13, and 6 ft are compared. That is consistent with vapor intrusion models that predict only modest attenuation of PCE with depth, because PCE is recalcitrant under aerobic conditions. Dramatic attenuation between 6 ft and 3.5 ft is visible in the exterior soil gas, which can be attributed to barometric pumping/mixing at shallow depths and potentially to the differences in stratigraphy in the shallowest soils. The lower concentration

distribution at the external 9 ft, which has also been observed in visualizations of datasets from specific time periods, is somewhat anomalous and has not been fully explained. The distributions in exterior soil gas consistently show much more interquartile variability than the distributions in interior multidepth soil gas. The interquartile variability increases with decreasing depth for the exterior clusters.

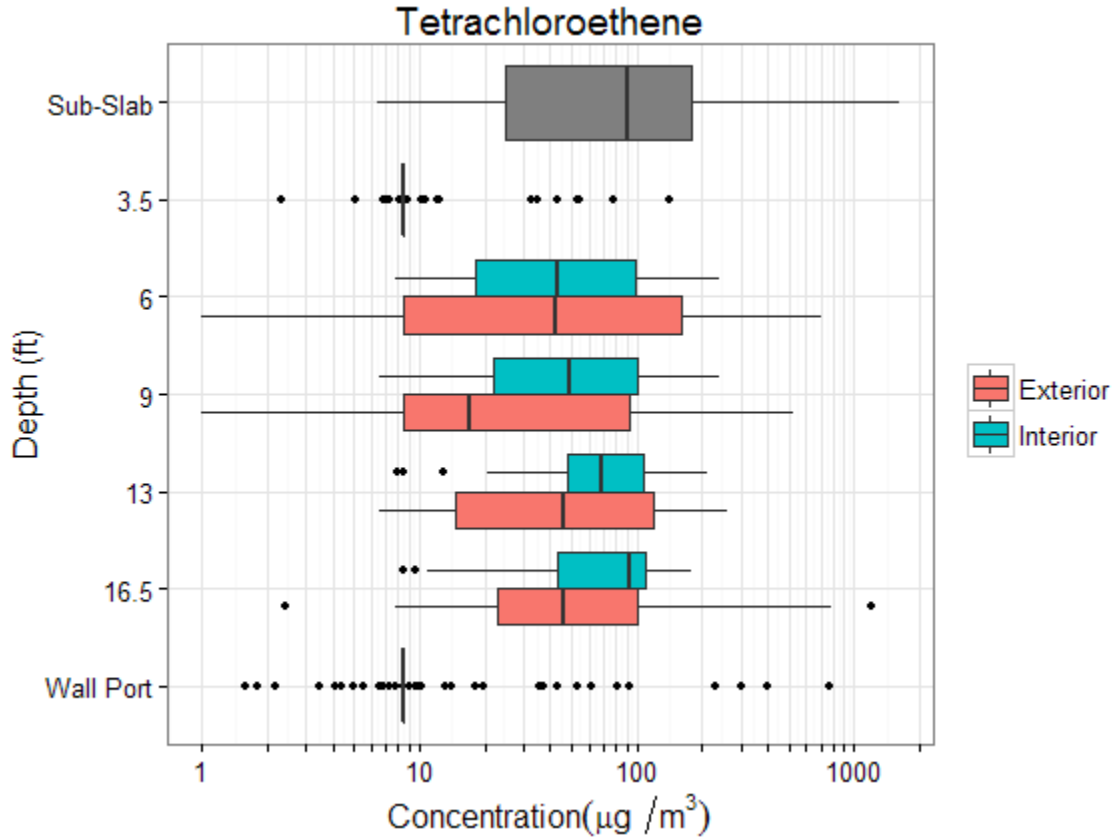

Figure 8-2. Box and whisker plots of PCE distribution at various depths.

8.1.3 Trichloroethylene (TCE)

At many sites, PCE and TCE have similar distributions because TCE is the first biodegradation product of PCE, and releases of mixed PCE/TCE sources are also common. At this site, however, TCE is much less frequently detected than PCE (see **Table 5-1** in Section 5.1.3). The most frequent depth of detection was subslab and 6 ft. The distributions in subslab and at 6-ft exterior soil gas are similar (**Figure 8-3**). Comparison of indoor and outdoor air concentrations over time suggests that ambient air is a primary source of TCE when concentrations are low but that subsurface sources are more important when VOC concentrations are higher (see Section 7).

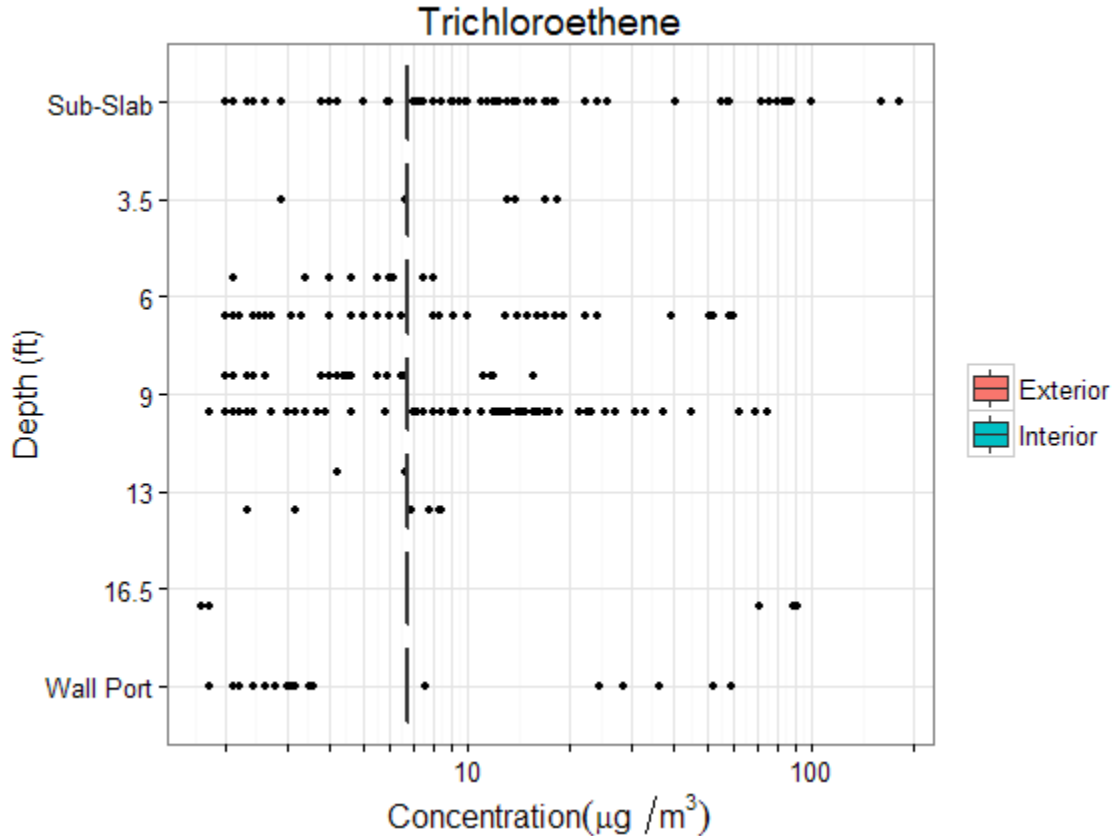

Figure 8-3. Box and whisker plots of TCE distribution at various depths.

8.1.4 Radon

The distribution of radon with depth (Figure 8-4) shows the highest concentrations at 6 ft and in subslab. Concentrations are relatively uniform with depth except at 3.5 ft. The interquartile distributions are notably narrower than those observed for the VOCs. This is consistent with a conceptual understanding in which radon is generated from a wide variety of geological materials surrounding the sampling points but has a relatively short half-life (days versus a year or more for PCE). The notably lower concentrations and wider interquartile range at 3.5 ft and for the wall port samples are consistent with a greater degree of barometric pumping expected in shallow soils.

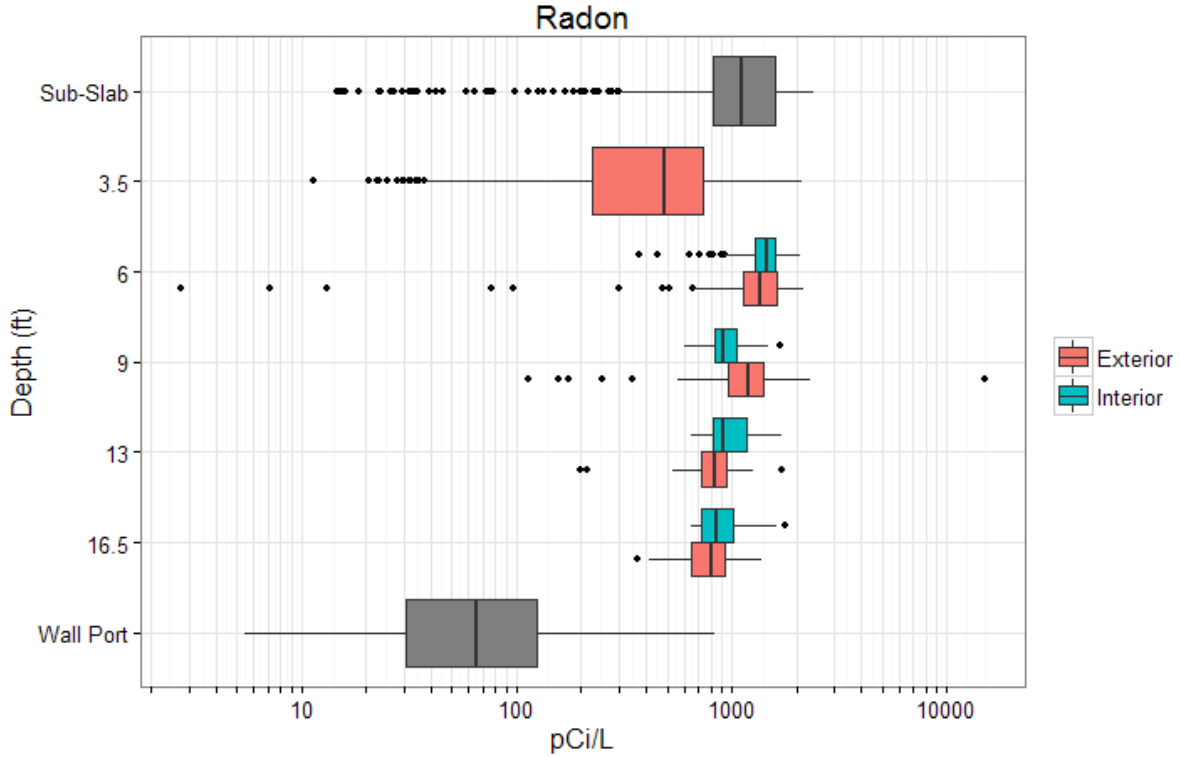

Figure 8-4. Box and whisker plots of radon concentration at various depths.

8.2 Comparison of Wall Ports to Subslab External Soil Gas

Concentrations in wall ports (see plots above and in Section 5.1.2) are generally quite low. This is consistent with their shallower depths and the notably lower concentrations in the 3.5-ft exterior soil gas samples.

It does not though necessarily follow that the flux through the basement walls is an insignificant contribution to vapor intrusion. It should be noted that the wall surface area is much higher than the basement floor surface area and that the relative volumetric gas flows through the walls and floor are not known. Tracer studies of this duplex in a follow-on project should provide greater insight on this question.

Table of Contents

9.	Results and Discussion: Over what durations do solvent extracted passive samplers provide useful integration of indoor air concentrations? (Is uptake rate constant?).....	9-1
9.1	Comparison of Daily to Weekly Samples	9-5
9.2	Comparison of Weekly to Biweekly Samples	9-8
9.3	Comparison of Weekly to Monthly Samples.....	9-9
9.4	Comparison of Weekly to Quarterly Samples	9-10
9.5	Comparison of Weekly to Semiannual and Annual Samples.....	9-10
9.5.1	Comparing Radiello Samplers to SKC Samplers.....	9-11
9.6	Conclusions	9-12

List of Figures

9-1.	Kernal densities of % <i>Bias</i> for important VOCs.....	9-4
9-2.	The effect of vapor pressure on sorbent performance.....	9-5

List of Tables

9-1.	Summary Statistics for % <i>Bias</i> by Comparison Period and VOC	9-3
9-2.	Summary Statistics Individual Concentration Measurements by VOC and Period.....	9-6
9-3.	Summary Statistics for % <i>Bias</i> Comparing Daily vs. Weekly Period and VOC	9-7
9-4.	Evaluation of Daily vs. Weekly Differences	9-8
9-5.	Evaluation of Weekly vs. Biweekly Differences (Outlier Included)	9-9
9-6.	Evaluation of Weekly vs. Biweekly Differences (Outlier Removed).....	9-9
9-7.	Evaluation of Weekly vs. Monthly Differences.....	9-10
9-8.	Evaluation of Weekly vs. Quarterly Differences	9-10
9-9.	Evaluation of Weekly vs. Semiannual Differences	9-11
9-10.	Evaluation of Weekly vs. Annual Differences.....	9-11
9-11.	Average % <i>Bias</i> for Average Weekly Radiello Measurements Compared with Semiannual and Annual Modified SKC 575 Charcoal Badges	9-12

9. Results and Discussion: Over what durations do solvent extracted passive samplers provide useful integration of indoor air concentrations? (Is uptake rate constant?)

The reliability of passive samplers in measuring VOC concentrations largely depends on whether the uptake rate is constant given the environmental conditions and the sample duration. Prolonged exposure of passive samplers can result in reduced net uptake rates due to back-diffusion or loss of sorptive capacity. Loss of adsorbed chemicals occurs when the concentration at the adsorbing surface is sufficiently high that the uptake rate decreases. To evaluate the performance of charcoal solvent-extracted passive samplers over periods ranging from 1 day to 1 year, the VOC concentrations measured for extended time intervals were compared with the average concentrations measured concurrently over shorter time segments. With the exception of a daily sample deployment over 7 days in the spring and again in the winter, the shortest interval used in our study was a 1-week duration. Weekly samples were collected concurrently with biweekly (2-week), monthly (4-week), quarterly (13-week), semiannual (26-week), and annual (52-week) samples.

For each sampling interval, Radiello charcoal passive samplers were deployed. The high sampling rates of the radial style sampler provided good sensitivity for indoor air measurements for the weekly samples. Additionally, the charcoal sorbent cartridge was selected over the thermally desorbable cartridge because of its stronger retention characteristics for the target VOCs and its higher VOC loading capacity, both beneficial attributes for long-term sample exposure. The uptake rates used to generate sample concentrations were published by the Radiello manufacturer, Fondazione Salvatore Maugeri, Padova, Italy, based on measurements in a standard atmosphere chamber (Sigma-Aldrich, 2012). The rates were corrected for the average temperature recorded over the sampling duration using the equation:

$$Q_K = Q_{298} \left(\frac{K}{298} \right)^{1.5}$$

where K is the measured temperature in Kelvin, Q_K is the uptake rate at temperature K , and Q_{298} is the published reference rate at 298K.

In addition to the Radiello sampler, the SKC 575 badge packed with charcoal and equipped with a secondary diffusive barrier was deployed for the two longest sampling periods, the semiannual and annual intervals. The badge paired with the secondary barrier has an uptake rate approximately 100 times lower than the Radiello sampler. With the exception of hexane, the modified badge uptake rates were provided by the manufacturer SKC Inc., Eighty Four, PA (Coyne, 2010). The uptake rate for hexane was estimated by dividing the standard published SKC 575 badge uptake rates by a factor of 28.5 based on the corresponding reduction in the diffusive surface area when using the secondary diffusive cover. This alternative sampler was deployed over 6 months and a year to determine if lower uptakes rates were more stable over the prolonged exposures and less subject to back-diffusion effects and possible interference from water adsorption. Discussion of the SKC badge performance as compared with the Radiello performance is presented in Section 9.6.

Evaluation of the passive sampler over the exposure period was determined by comparing the numerical average of the shorter time segments (e.g., 2 weeks, 4 weeks) to the concurrent integrated measurement (e.g., biweekly, monthly). For each interval evaluated, the relative percent difference (%Bias) was calculated using the equation:

$$\%Bias = \frac{C_A - C_I}{(C_A + C_I/2)} \times 100\%$$

C_A = Average concentration of the shorter duration sample

C_I = Measured concentration of integrated sample over same period

A positive %Bias value indicates the average concentration of the shorter duration measurements was higher as compared with the longer integrated sample concentration. Similarly, a negative %Bias indicates that the shorter measurement technique will underestimate the actual vapor concentration. Several explanations are possible for a positive bias. A positive %Bias is expected when the actual uptake rate is lower than the published rate such as in the case of back-diffusion. Also, a positive %Bias can be observed when the shorter duration has a high bias due to artifacts from the sorbent material or the extraction process. The acceptance criterion to demonstrate equivalency is $\pm 30\%$, which was established as equivalent to the data quality objective set for replicate samples for this work, based on what is defined as acceptable reproducibility in vapor intrusion field studies. If the reported concentration was a nondetect, the %Bias calculation was performed using half of the reporting limit for the corresponding concentration. **Table 9-1** displays summary statistics of the %Bias for each target VOC by type of comparison period (weekly vs. biweekly, weekly vs. monthly, weekly vs. semiannual, or weekly vs. annual). With the exemption of PCE (biweekly and monthly) and toluene (biweekly and semiannual), the average of the %Bias favored the shorter measurements for all comparison periods (i.e., the longer period sample consistently underestimated the actual vapor concentration) and all VOCs. Chloroform and hexane showed the two larger standard deviations with respect to the average of %Bias across all comparison periods, while toluene and tetrachloroethene had smaller standard deviations. A combination of a smaller average concentration and larger standard deviation results in a high rate of %Bias not meeting the acceptance criterion as shown in **Figures 9-1**.

Figure 9-1 displays the %Bias density plots for each VOC and each interval comparison. The dotted line represents a %Bias of 0, and the solid lines bracket the acceptance criterion of $\pm 30\%$. Density plots are approximations to the probability distribution of the data and are affected by the sample size, so caution must be used when interpreting density plots based on small samples ($n < 30$). As shown in the legend of **Figure 9-1**, the number of available comparisons was less than 30 for the 3-month and longer durations. **Figure 9-1** and **Table 9-1** show that as the period of measurements increase (e.g., quarterly, semiannual, annual) the distribution of %Bias moves away from zero, suggesting that weekly measurements are increasingly greater than the concentrations determined by integrated measurement.

Table 9-1 and **Figure 9-1** show the proportion of %Bias satisfying the acceptance criteria. The %Bias for benzene, chloroform, and hexane shifts in the positive direction as the measurement time period increases from monthly to annually, under the concentration ranges seen in our test house. Based on these plots, this particular passive sampler performs as follows for the chemicals tested:

- Chloroform: performs well up to a 14-day integration period but degrades by 28 days
- Benzene and TCE: performs well up to a 28-day integration period but degrades by 91 days
- Hexane: performs well up to a 91-day integration period but degrades by 182 days
- PCE and toluene: performs well up to 364 days

Extending the sampling duration to quarterly shows that only benzene, hexane, PCE, and toluene have maintained a relatively stable uptake rate as defined by the %Bias criterion of $\pm 30\%$. The average %Bias for TCE and the density plot shift to the right, indicating that the uptake rate is showing a drop over the quarterly interval.

Figure 9-2 shows that as the period of measurements increases from biweekly to annually, the number of %Bias satisfying the equivalency rate decreases for all VOCs except toluene.

Section 9—Results and Discussion: Over what durations do solvent extracted passive samplers provide useful integration of indoor air concentrations?(Is uptake rate constant?)

Table 9-1. Summary Statistics for %Bias by Comparison Period and VOC

	N	Minimum	25%	Median	Mean	75%	Maximum	SD
Weekly vs. Biweekly								
Benzene	175	-46.20	-3.35	9.30	7.74	20.05	50.50	16.98
Chloroform	175	-72.00	0.00	11.30	11.15	23.80	59.20	18.55
Hexane	175	-67.40	-7.90	3.50	2.75	14.85	59.60	18.85
Tetrachloroethene	175	-57.90	-7.50	0.00	-0.44	6.50	29.80	11.78
Toluene	175	-66.70	-5.60	0.50	-0.02	6.70	33.60	12.13
Trichloroethene	175	-51.20	1.60	9.80	10.98	19.60	67.40	17.23
Weekly vs. Monthly								
Benzene	84	-20.80	0.53	13.90	13.39	23.83	59.30	16.80
Chloroform	84	-28.60	12.60	28.35	31.39	47.58	94.30	26.89
Hexane	84	-44.90	-1.15	12.45	11.33	26.63	50.90	20.00
Tetrachloroethene	84	-26.10	-7.18	-1.65	-0.47	7.40	23.10	10.89
Toluene	84	-25.20	-6.55	-0.15	0.03	5.58	35.20	10.68
Trichloroethene	84	-19.90	7.55	20.35	19.09	27.35	81.30	17.65
Weekly vs. Quarterly								
Benzene	28	8.10	21.48	31.00	33.05	43.05	61.70	14.83
Chloroform	28	18.20	57.40	85.80	88.29	114.10	172.30	43.58
Hexane	28	-13.40	12.37	22.00	23.05	31.22	68.20	19.29
Tetrachloroethene	28	-16.00	-0.95	5.80	5.88	10.80	25.00	10.82
Toluene	28	-16.10	-6.13	-0.05	2.37	10.90	25.00	12.03
Trichloroethene	28	6.80	17.38	37.15	34.17	46.65	59.10	15.94
Weekly vs. Semiannual								
Benzene	14	25.40	33.15	37.20	39.48	46.40	62.80	10.89
Chloroform	14	89.30	125.30	155.90	147.00	177.20	187.80	36.58
Hexane	14	7.00	19.05	33.45	31.61	43.88	58.20	16.71
Tetrachloroethene	14	-15.00	-8.70	5.05	2.93	10.65	27.10	12.44
Toluene	14	-19.40	-14.65	-6.40	-4.84	1.33	18.80	11.41
Trichloroethene	14	19.50	35.60	41.65	41.57	46.68	64.80	11.91
Weekly vs. Annual								
Benzene	7	51.90	55.20	56.70	60.81	67.90	70.90	7.91
Chloroform	7	162.60	165.60	171.20	172.30	178.00	185.40	8.45
Hexane	7	41.60	53.10	77.10	67.19	80.95	83.50	18.10
Tetrachloroethene	7	14.60	17.20	20.30	22.37	27.25	32.80	7.54
Toluene	7	-10.30	-3.25	0.90	0.80	4.65	12.20	7.77
Trichloroethene	7	58.50	65.80	69.60	69.30	72.60	80.20	7.25

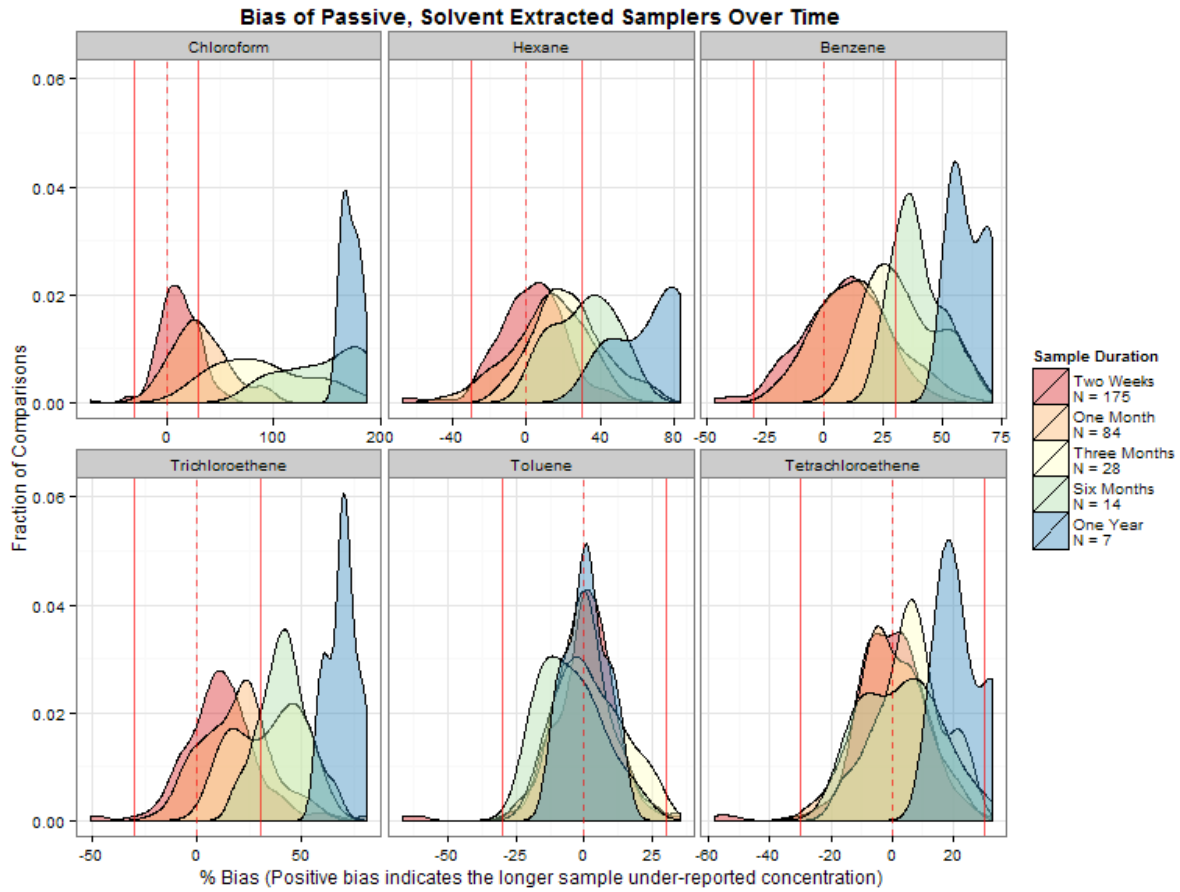

Figure 9-1. Kernel densities of %Bias for important VOCs.

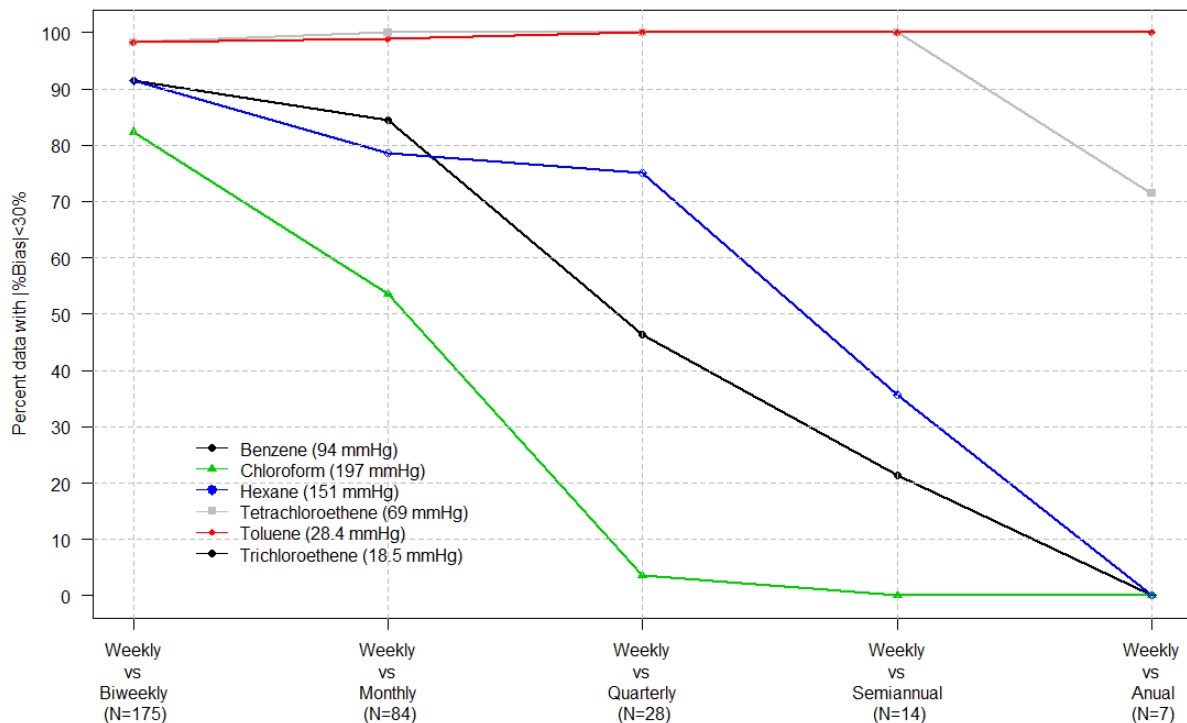

Figure 9-2. The effect of vapor pressure on sorbent performance.

9.1 Comparison of Daily to Weekly Samples

Daily sample collection was planned using badge-style samplers paired with thermally desorbable sorbents to provide improved sensitivity as compared with the solvent-extracted Radiello sampler (Section 2.1.4); however, deployment was not successful because of unexpected media and laboratory difficulties. As a result, the Radiello charcoal samplers were deployed daily at the seven sampling points (six indoor and one outdoor) in the spring from March 2, 2011, to March 9, 2011, and again in the winter from December 7, 2011, to December 15, 2011. In order to achieve sufficient sensitivity to measure expected concentrations over 24 hours, the laboratory was required to lower the analytical reporting limits for the chlorinated solvents by a factor of 5 to 10 as compared with the standard analytical method. To accomplish this increase in sensitivity, the mass spectrometer was operated in the selected ion monitoring (SIM) mode, and the calibration levels were adjusted to meet reporting limit requirements. The reporting limit could not be lowered for benzene and hexane because of background levels in the sorbent tube and from the extraction process. **Table 9-2** shows descriptive statistics for the VOCs by measurement period.

Section 9—Results and Discussion: Over what durations do solvent extracted passive samplers provide useful integration of indoor air concentrations?(Is uptake rate constant?)

Table 9-2. Summary Statistics Individual Concentration Measurements by VOC and Period

Period	N	Min.	1st Qu.	Median	Mean	3rd Qu.	Max.	SD
Daily								
Benzene	86	0.81	1.00	1.30	1.74	2.00	7.70	1.12
Chloroform	86	0.23	0.26	0.50	0.82	0.80	6.60	1.10
Hexane	86	0.52	0.75	1.05	1.31	1.58	4.20	0.82
Tetrachloroethene	86	0.09	0.21	0.45	0.50	0.66	1.50	0.35
Toluene	86	0.44	0.86	1.10	1.89	2.05	8.00	1.94
Trichloroethene	86	0.04	0.06	0.06	0.09	0.10	0.41	0.06
Weekly								
Benzene	371	0.36	0.57	0.75	0.80	0.94	2.30	0.30
Chloroform	371	0.06	0.12	0.20	0.33	0.38	4.00	0.42
Hexane	371	0.23	0.42	0.56	0.68	0.80	2.60	0.38
Tetrachloroethene	371	0.08	0.22	0.37	1.06	0.67	22.00	2.36
Toluene	371	0.50	0.96	1.40	1.76	2.35	6.00	1.08
Trichloroethene	371	0.01	0.04	0.05	0.12	0.08	2.70	0.26
Biweekly								
Benzene	191	0.38	0.58	0.67	0.72	0.85	1.60	0.23
Chloroform	191	0.07	0.11	0.20	0.35	0.42	3.70	0.42
Hexane	191	0.25	0.47	0.59	0.66	0.74	2.00	0.31
Tetrachloroethene	191	0.10	0.25	0.43	1.22	0.79	12.00	2.27
Toluene	191	0.52	1.20	1.70	1.79	2.15	5.30	0.94
Trichloroethene	191	0.02	0.04	0.05	0.13	0.09	1.40	0.22
Monthly								
Benzene	99	0.43	0.59	0.68	0.69	0.78	1.40	0.16
Chloroform	99	0.04	0.09	0.14	0.27	0.27	2.30	0.37
Hexane	99	0.24	0.48	0.58	0.62	0.74	1.80	0.23
Tetrachloroethene	99	0.14	0.21	0.32	1.08	0.68	13.00	2.22
Toluene	99	0.68	1.10	1.60	1.75	2.20	4.20	0.71
Trichloroethene	99	0.02	0.03	0.04	0.11	0.09	1.20	0.21
Quarter								
Benzene	28	0.40	0.49	0.60	0.58	0.65	0.71	0.09
Chloroform	28	0.02	0.05	0.09	0.17	0.15	1.00	0.23
Hexane	28	0.34	0.43	0.53	0.55	0.67	0.80	0.14
Tetrachloroethene	28	0.15	0.27	0.33	1.01	1.05	5.90	1.35
Toluene	28	0.88	1.48	1.80	1.74	2.00	3.00	0.50
Trichloroethene	28	0.02	0.03	0.05	0.10	0.11	0.48	0.11
Semi-annual								
Benzene	14	0.41	0.48	0.55	0.53	0.58	0.65	0.07
Chloroform	14	0.01	0.02	0.04	0.05	0.08	0.14	0.04
Hexane	14	0.34	0.42	0.47	0.51	0.58	0.75	0.13
Tetrachloroethene	14	0.22	0.42	0.84	1.05	1.40	3.00	0.79
Toluene	14	1.20	1.53	1.95	1.93	2.35	2.70	0.46
Trichloroethene	14	0.04	0.05	0.07	0.08	0.11	0.18	0.04
Annual								
Benzene	7	0.38	0.40	0.43	0.44	0.46	0.54	0.06
Chloroform	7	0.01	0.02	0.03	0.03	0.04	0.06	0.02
Hexane	7	0.29	0.29	0.33	0.37	0.39	0.60	0.11
Tetrachloroethene	7	0.56	0.68	0.83	0.90	0.92	1.70	0.38
Toluene	7	1.60	1.75	1.80	1.89	2.00	2.30	0.26
Trichloroethene	7	0.05	0.06	0.06	0.06	0.07	0.09	0.01

Section 9—Results and Discussion: Over what durations do solvent extracted passive samplers provide useful integration of indoor air concentrations?(Is uptake rate constant?)

Because of the short exposure time of the daily samples and the low concentrations at the site, the mass collected for each target compound was typically below the reporting limit, or the mass measured was biased high because of background levels in the sampling/analysis method. Even with the lowered reporting limit and reporting results down to the MDL, many site samples showed nondetects for the chlorinated solvents (cis-1,2-DCE, TCE, and chloroform) making comparisons with the weekly integrated measurement less useful. Of 86 daily samples collected, the percentage nondetects were benzene 92%, chloroform 78%, hexane 59%, PCE 8%, toluene 44%, and PCE 77%.

Because PCE was typically at or slightly above the reporting limit in the daily samples (typically 0.12 $\mu\text{g}/\text{m}^3$), the average of the concentrations correlated better with the weekly measurements. PCE concentrations from the daily sample collection ranged from 0.09 to 1.50 $\mu\text{g}/\text{m}^3$ (**Table 9-2**). Chloroform performed well when comparing the average 24-hour exposure times with the weekly measurements when concentrations were above 0.5 $\mu\text{g}/\text{m}^3$.

The daily samples did not provide accurate concentrations for benzene or hexane because the mass measured on each sampler was similar to the mass detected in the associated laboratory blanks. The average benzene and hexane mass measured on the daily samples was 0.19 and 0.12 μg , respectively. In terms of concentration, this mass translates to approximately 1.74 $\mu\text{g}/\text{m}^3$ benzene and 1.31 $\mu\text{g}/\text{m}^3$ hexane. Benzene was detected in each laboratory blank with an average blank concentration of 0.086 μg (approximately 0.75 $\mu\text{g}/\text{m}^3$ for a 24-hour period). Hexane was detected in one-half of the lab blanks with an average concentration of 0.053 μg (approximately 0.56 $\mu\text{g}/\text{m}^3$). As a result, both benzene and hexane showed a positive bias when comparing the daily average with the weekly measurement because of the high bias from background artifacts. Despite background detections of toluene in all of the associated laboratory blanks averaging 0.018 μg , the mass measured in each daily sample was typically 10 times higher, resulting in minimal bias for the average daily calculated concentration (**Table 9-3**).

Table 9-3. Summary Statistics for %Bias Comparing Daily vs. Weekly Period and VOC

Comparison Period	Minimum	25%	Median	Mean	75%	Maximum	SD
Daily vs. weekly							
Benzene	18.5	34.93	48.05	48.99	55.7	102	20.74
Chloroform	-7.6	16.8	43.15	55.10	96.35	121.5	43.94
Hexane	-47.1	-45.22	-33.3	-27.2	-29.08	60.4	28.94
Tetrachloroethene	-19.1	-3.325	39.55	39.93	84.85	110.2	45.60
Toluene	-39.2	-0.225	4.40	3.736	8.825	44.10	17.21
Trichloroethene	-30.4	-20.52	-2.55	-3.893	13.92	21.2	18.39

Table 9-4 displays the difference between daily and weekly measurements. Strong statistical significance ($p\text{-value} < 0.001$) was detected between the durations for benzene, chloroform, and hexane.

In summary these results suggest that the solvent-extracted Radiello sampler is better used for durations longer than 1 day, if concentrations are at or below the indoor air concentrations we measured. Other passive samplers with higher uptake rates are available that are more suitable for short durations at such low concentrations.

Table 9-4. Evaluation of Daily vs. Weekly Differences

VOC	Estimated Differences Between Durations (% bias)	Standard Error of the Estimated Differences (% Bias)	P-Value
Benzene	37.0	6.1	0.000***
Chloroform	29.7	12.9	0.000***
Hexane	13.6	13.4	0.006**
Tetrachloroethene	-6.2	5.1	0.431
Toluene	-14.5	5.4	0.443
Trichloroethene	-8.9	14.4	0.164

** Denotes statistical significance at 0.01

***Denotes statistical significance at 0.001

9.2 Comparison of Weekly to Biweekly Samples

For this comparison, weekly sample averages were subtracted from the corresponding biweekly samples. The normality assumption was then evaluated using the Shapiro Wilks test implemented in the software package Nortest in the R statistical language and environment. The Shapiro Wilks test has more power to detect normality compared with other normality tests such as the Kolmogorov Smirnov test (Razali and Wah, 2011). For large sample sizes ($n > 30$), the central limit theorem was used to justify normality of the average measures. To decide whether the data can be considered a random sample or independent and identically distributed, a random test or simple sign test was used. If an observed value in the sequence is influenced by its position in the sequence or by the observations that precede it, the sequence of data points is not truly a random sample. Paired t-tests were used to compare the weekly to the biweekly sample averages when both the normality and independence assumptions held. When the independence assumption failed, a t-test accounting for the correlation in the data was used.

Comparisons were performed with (Table 9-5) and without (Table 9-6) the presence of an outlier sample that was identified as such but could not be explained.¹ In both tables, strong statistical significance (p -value < 0.001) was detected for benzene, chloroform, and TCE. Borderline significance (p -value = 0.055) and significance (p -value < 0.05) were detected for hexane with and without the outlier, respectively. The differences between the two sequential 7-day samples and the corresponding 14-day samples were thus small but consistent. Because the study included 175 such comparisons for each compound, the small differences achieved statistical significance.

The Radiello sampler performed well over the biweekly period with average %Bias for each target VOC well within the 30% acceptance criterion. For the more volatile compounds tested, the measured concentration was consistently slightly lower in the 14-day samples. Practitioners may choose, however, to accept that slight bias in order to gain more cost-effective long-duration observations to account for temporal variability.

¹ The sample identified as an outlier had concentrations of benzene = 1.7, chloroform = 64, hexane = 0.84, PCE = 49, toluene = 3.5, and TCE = 2.4 $\mu\text{g}/\text{m}^3$. We removed this from the analysis in Table 9-4 because, although we could find no issues with the sample or its analysis, the measured concentrations did not appear reasonable based on the other measurements.

Table 9-5. Evaluation of Weekly vs. Biweekly Differences (Outlier Included)

VOC	Estimated Differences Between Durations (%Bias)	Standard Error of the Estimated Differences (%Bias)	P-Value
Benzene	7.7	1.84	0.000***
Chloroform	11.1	1.94	0.000***
Hexane	2.8	1.42	0.055
Tetrachloroethene	-0.4	0.89	0.619
Toluene	0.0	0.92	0.980
Trichloroethene	11.0	1.89	0.000***

***Denotes statistical significance at 0.001

Table 9-6. Evaluation of Weekly vs. Biweekly Differences (Outlier Removed)

VOC	Estimated Differences Between Durations (%Bias s)	Standard Error of the Estimated Differences (%Bias)	P-Value
Benzene	8.0	1.92	0.000***
Chloroform	11.6	2.01	0.000***
Hexane	3.1	1.38	0.025*
Tetrachloroethene	-0.1	0.84	0.864
Toluene	0.4	0.84	0.668
Trichloroethene	11.3	1.98	0.000

* Denotes statistical significance at 0.05

***Denotes statistical significance at 0.001

9.3 Comparison of Weekly to Monthly Samples

A paired t-test was used to evaluate the significance of the difference between weekly and monthly samples (Table 9-7). The p-value statistic shows that the %Bias of weekly measurements vs. monthly is significantly different from zero for benzene, chloroform, hexane, and TCE, suggesting that weekly concentrations are larger than monthly concentrations and that monthly measurements would tend to underestimate VOC concentrations in indoor air. Although the amount of underestimation, from 11% to 31%, is generally within the target accuracy range, it is consistently biased low. Practitioners may choose to accept or correct for that slight bias in order to gain more cost-effective long-duration observations to account for temporal variability.

Table 9-7. Evaluation of Weekly vs. Monthly Differences

VOC	Estimated Differences Between Durations (%Bias)	Standard Error of the Estimated Differences (%Bias)	P-Value
Benzene	13.4	2.98	0.001***
Chloroform	31.4	6.30	0.000**
Hexane	11.3	2.18	0.000***
Tetrachloroethene	-0.5	1.19	0.696
Toluene	0.0	1.17	0.977
Trichloroethene	19.1	3.35	0.000***

***Denotes statistical significance at 0.001

9.4 Comparison of Weekly to Quarterly Samples

The difference between weekly and quarterly measurements (**Table 9-8**) is statistically significantly different from zero for benzene, chloroform, hexane, tetrachloroethene, and TCE, using a t-test. The direction is consistent—weekly concentrations are larger than quarterly concentrations. Although the average bias of PCE and hexane are below the 30% criterion, with 28 comparison datasets for each compound we were able to detect these modest variations with statistical confidence. However, for all of the tested compounds except chloroform a practitioner might choose to accept or correct for the negative bias in the concentration estimate for the quarterly sample in order to benefit from the dramatic cost savings from using one passive sampler rather than 13 successive 7-day passive samples.

Table 9-8. Evaluation of Weekly vs. Quarterly Differences

VOC	Estimated Differences Between Durations (%Bias)	Standard Error of the Estimated Differences (%Bias)	P-Value
Benzene	33.1	5.52	0.009**
Chloroform	88.3	23.00	0.031*
Hexane	23.1	3.65	0.000***
Tetrachloroethene	5.9	2.04	0.008**
Toluene	2.4	2.27	0.307
Trichloroethene	34.2	6.73	0.015*

*Denotes statistical significance at 0.05

**Denotes statistical significance at 0.01

***Denotes statistical significance at 0.001

9.5 Comparison of Weekly to Semiannual and Annual Samples

The difference between weekly and semiannual measurements (**Table 9-9**) is statistically significantly different (t-test) from zero for hexane, suggesting that weekly concentrations are larger than semiannual concentrations. The estimated differences (**Table 9-9**) and mean bias (**Table 9-1**) for benzene, TCE, chloroform were substantially greater than the 30% criteria. The estimated difference and mean bias for hexane only slightly exceeded the criteria. This suggests larger weekly measurements compared with

corresponding semiannual values and a greater underestimation of indoor air concentrations with longer term samples.

By inspection, it seems unintuitive that the large estimated difference for chloroform as shown in this table and in **Table 9-1** is associated with such a high p-value. However, we have rechecked this result, and it is mathematically correct because of the structure of the dataset and the small number of comparisons (N=14).

Table 9-9. Evaluation of Weekly vs. Semiannual Differences

VOC	Estimated Differences Between Durations (%Bias)	Standard Error of the Estimated Differences (%Bias)	P-Value
Benzene	39.5	5.48	0.088
Chloroform	147.0	31.46	0.134
Hexane	31.6	4.46	0.000***
Tetrachloroethene	2.9	3.32	0.394
Toluene	-4.8	3.05	0.137
Trichloroethene	41.6	8.39	0.127

***Denotes statistical significance at 0.001

The difference between weekly measurements and annual (**Table 9-10**) is statistically significantly different from zero for hexane and tetrachloroethene, suggesting that weekly concentrations are consistently larger than annual concentrations. Caution must be used when interpreting significance given the small sample size, which was not sufficient to compare weekly and annual values for benzene, chloroform, and TCE. The estimated differences (**Table 9-10**) and mean %Bias (**Table 9-1**) for both toluene and PCE were both lower than the 30% criteria even over the full-year duration.

Table 9-10. Evaluation of Weekly vs. Annual Differences

VOC	Estimated Differences Between Durations (%Bias)	Standard Error of the Estimated Differences (%Bias)	P-Value
Benzene	Not enough data	Not enough data	Not enough data
Chloroform	Not enough data	Not enough data	Not enough data
Hexane	66.7	2.38	0.02*
Tetrachloroethene	21.4	0.77	0.02*
Toluene	0.8	0.05	0.58
Trichloroethene	Not enough data	Not enough data	Not enough data

*Denotes statistical significance at 0.05

9.5.1 Comparing Radiello Samplers to SKC Samplers

In addition to the Radiello samplers, SKC charcoal badge samplers were also deployed over the 26-week and 52-week periods. The badges were equipped with a secondary diffusive cover to lower the uptake rate by about 28.5 times as compared with the standard SKC 575 badge configuration. This modified badge uptake rate was approximately 100 times lower than the Radiello charcoal sampler. The %Bias calculations for the SKC badge semiannual and annual sample measurements are listed in **Table 9-11**.

Table 9-11. Average %Bias for Average Weekly Radiello Measurements Compared with Semiannual and Annual Modified SKC 575 Charcoal Badges

Compound	26-Week Average vs. SKC 575 Semi-annual Measurement	52-Week Average vs. SKC 575 Annual Measurement
Chloroform	-54	-35
Hexane	-90	-90
Benzene	-74	-39
Trichloroethene	-58	-23
Toluene	-32	-33
Tetrachloroethene	1.0	13
# Observations per compound	14	6*

Despite the prolonged exposures, the low badge sampling rates of approximately 0.5 mL/min resulted in relatively high VOC reporting limits in the 0.3 to 1.0 $\mu\text{g}/\text{m}^3$ range. For the chlorinated solvents, most results were below or just above the detection limit. In the case of benzene, hexane, and to a lesser degree TCE, the associated blank levels contributed to a high bias of the measurement. Because the average of the weekly Radiello measurement was lower than the extended badge measurement, the %Bias for all compounds except PCE was negative.

The %Bias became less negative for benzene and TCE over the longer period because the background mass from the blank was proportionally less than the sample mass adsorbed by the badge sampler. The average mass of benzene measured on the badge blanks was 0.14 μg , and the average sample mass measured on the field samplers was 0.34 μg and 0.57 μg for the semiannual and annual periods, respectively. Blank levels of hexane averaged 0.12 μg on the badge samplers with average sample mass concentrations of 0.24 and 0.52 μg for the semiannual and annual samples. The laboratory also reported TCE in several of the blanks above the detection limit but below the reporting limit. The average TCE mass in the SKC blanks was 0.011 μg , the average mass measured for the semiannual samples was 0.029 μg , and the average mass measured for the annual samples was 0.047 μg .

Overall, the SKC badge concentrations were higher than the average weekly Radiello measurements even for those VOCs without significant blank contributions such as chloroform and toluene. As was the case with the Radiello charcoal sampler, the semiannual and annual PCE concentrations compared well with the corresponding weekly Radiello measurements. The %Bias data also suggest that uptake rates may be more uniform for the more volatile VOCs using the modified badge than with the Radiello sampler for extended periods. For example, TCE appeared to have a more stable uptake rate using the badge sampler when comparing the %Bias of the annual badge sampler with the annual Radiello sampler. Although the badge %Bias shifts in the positive direction when extending the duration from 26 weeks to 52 weeks, the shift appears to be more a function of the badge blank levels resulting in a higher concentration at 6 months than due to a drop in the sampling rate over the year-long period.

9.6 Conclusions

Overall, the radial-style charcoal passive sampler performance over periods from 1 day to 1 year was dependent on the target compound. For the shortest duration of 1 day, the background contribution from the sorbent and the extraction procedure did not allow for accurate quantitation of benzene and hexane at concentrations of $<2.0 \mu\text{g}/\text{m}^3$. Additionally, the analytical sensitivity of the solvent-extraction technique was not sufficient to measure indoor air concentrations at the site without enhancements to the detector sensitivity. All target compounds showed excellent agreement between the numerical averages of the

weekly exposures and the 2-week integrated measurement, suggesting uniform uptake rates over this period within a tolerance appropriate to environmental chemistry. Benzene, hexane, toluene, and PCE exhibited stable uptake rates at 4 weeks, as when evaluating the dataset with concentrations above the detection limit. The average % *Bias* for chloroform was just outside the criterion at the 4-week period. Hexane performed well for durations up to 13 weeks and was slightly above the bias criteria at 26 weeks. Toluene and PCE continued to demonstrate stable uptake rates at the quarterly, semiannual, and annual intervals within our 30% tolerance criteria.

In general, the %*Bias* data suggest that the stability of the uptake rate is a function of the compound's volatility, as measured by vapor pressure. As shown in **Figures 9-2** and **9-3**, the VOCs with higher vapor pressures shifted toward a positive bias at shorter exposure intervals than VOCs with lower vapor pressures. The maximum sampling duration defined by meeting the average %*Bias* criterion follows the expected order from shortest to longest based on the compound's volatility. The most volatile VOC, chloroform, was the first VOC to exceed the average $\pm 30\%$ criterion during the study, and sampling intervals could not be extended beyond 4 weeks. Benzene and TCE were similar in their volatility and essentially showed comparable performance in their %*Bias* data, exceeding the criterion in the quarterly interval measurement. Hexane was a slight exception to the volatility order performing better than would have been expected at the 13-week duration. The two least volatile compounds, toluene and PCE, demonstrated a uniform uptake rate over the course of a year.

Given the VOC concentrations at the site, the charcoal sorbent cartridge had sufficient capacity for a 52-week duration with mass loadings onto the cartridges well under the manufacturer's recommended limit of 80 mg. The sum of the target VOC masses collected on the sampler for the year-long samples was less than 0.2 mg for all of the samples, and the total mass on the samplers was estimated to be generally less than 1 mg. Additionally, water adsorption did not appear to be interference in the sampler performance and did not result in any negative effects during sample extraction or analysis. If VOC concentrations are significantly higher than what was measured at this site, additional consideration should be made regarding extending the sampling duration to ensure sampler capacity is not exceeded.

The concept of reducing the uptake rate on a charcoal passive sampler to extend the sampling interval is promising based on the data generated using the modified SKC 575 badge. This small and very limited dataset suggested that uptake rates may be more stable for more volatile VOCs over extended durations of up to a year. However, blank levels can make accurate measurements challenging when concentrations and uptake rates are very low.

Table of Contents

10. Results and Discussion: Determine if observed changes in indoor air concentration of volatile organics of interest are mechanistically attributable to changes in vapor intrusion	10-1
10.1 Air Exchange Rate Results and Seasonal Variability—Does this Control Indoor Air Concentration?.....	10-1
10.2 Direct Differential Pressure Results—Are They Predictive of Indoor Air Concentrations by Themselves?	10-3
10.3 Inferred Driving Force from Temperature Differentials—Is This Predictive of Indoor Air Concentrations by Itself?.....	10-8
10.4 HVAC System Cycles	10-12
10.5 Trends in Subslab Concentration—Do They Predict Indoor Air Concentration Trends by Themselves?	10-16
10.6 Do Trends In Shallow and Deep Soil Gas Predict Indoor Air Concentrations?.....	10-16
10.7 Ambient Concentrations—Are They Significant?.....	10-17
10.8 Potentiometric Surface/Water Levels—Do They Predict Subslab Concentrations?	10-17

List of Figures

10-1. 422 subslab vs. basement differential pressure (positive values indicate greater pressurization of the subslab and thus flow toward the basement).....	10-4
10-2. Basement vs. upstairs differential pressure (positive values indicate pressurization of the basement relative to the upstairs).....	10-5
10-3. Deep vs. shallow soil gas differential pressure beneath 422 East 28th Street (positive values indicate a greater pressure in the deep soil gas relative to the shallow soil gas).	10-5
10-4. Basement vs. exterior (above grade) differential pressure at 422 East 28th Street (positive values indicate that the basement pressure is higher than the pressure in exterior air).....	10-6
10-5. Subslab vs. basement differential pressure at 420 East 28th Street (positive values indicate higher pressure in subslab than in the basement, thus flow toward the basement).	10-7
10-6. Exterior barometric pressure measurements over time, 420/422 East 28th Street.....	10-7
10-7. Stack effect driving force for 422 East 28th Street over time.....	10-9
10-8. Stack effect driving force 420 (unheated) side over time.	10-9
10-9. Summer and fall interior and ambient temperatures.	10-10
10-10. PCE concentrations in indoor air vs. stack effect driving force (log scale of concentration).	10-11
10-11. Chloroform concentrations in indoor air vs. stack effect driving force (log scale of concentration).	10-11
10-12. Radon concentrations (electret measurements) in indoor air vs. stack effect driving force.	10-12
10-13. Differential pressure measurements graphed with HVAC system on/off cycles; HVAC system status at times when basement vs. exterior differential pressure was observed is annotated.	10-14
10-14. Selected period of indoor and ambient temperature data, green arrow marks December 18 to December 23 HVAC system outage.	10-14
10-15. Selected period of indoor and ambient temperature data, green arrow shows March 11 to March 16 period of HVAC outage.....	10-15
10-16. PCE, online GC data, 422 side, larger data points used to mark periods of heating system failure.	10-15
10-17. Average depth to water at house, discharge of nearby creek (USGS) and rainfall at house compared (intensive sampling rounds shown with vertical lines).	10-18
10-18. Storm and sanitary sewers near the test duplex at 420/422 East 28th Street.	10-19
10-19. Floor drain in first floor laundry room on 422 side of duplex.	10-20

List of Tables

10-1. April/May 2011 Air Exchange Rate Measurement Results..... 10-1
10-2. September 2011 Air Exchange Rate Measurement Results..... 10-2
10-3. National Survey of Air Exchange Rates, Reprinted from the *EPA Exposure Factor Handbook* (U.S. EPA, 2011)..... 10-2
10-4. Drain Sampling Data April 13–April 21, 2011 ($\mu\text{g}/\text{m}^3$) 10-21
10-5. *NY Times* Database Report on Indianapolis Drinking Water Showing Relative Concentrations of PCE and Chloroform 10-21

10. Results and Discussion: Determine if observed changes in indoor air concentration of volatile organics of interest are mechanistically attributable to changes in vapor intrusion

10.1 Air Exchange Rate Results and Seasonal Variability—Does this Control Indoor Air Concentration?

Air exchange rate measurements were performed using EPA Method IP-4A, which uses passive emitters and passive samplers known as capillary adsorption tube samplers (CATS) from

- April 27 to May 11, 2011, and
- September 23 to September 29, 2011.¹

The emitters were evenly spaced across their respective floors of the 422 side of the duplex:

- 10 perfluorodimethylcyclohexane (PDCH) emitters in the basement
- 10 perfluoromethylcyclohexane (PMCH) emitters on the first floor
- 9 PMCH emitters on the second floor

No emitters were placed on the 420 side of the duplex, but CATS measurements were made there in the April/May round to estimate the amount of airflow between sides of the duplex. The emitters were deployed on April 22, 2011, to allow the building to come to equilibrium before sampling and were essentially left in place throughout the measurement periods.

As shown in **Table 10-1**, the April/May 422 basement air exchange rates showed excellent agreement for the duplicates (both 0.74/hour). As shown in **Table 10-2**, the September measurements for the basement (0.64/hour and 0.82/hour) are more variable but bracket the April/May measurements. The first floor measurements were lower in both measurement periods (0.56 in April/May and 0.48 in September). The September measurements show a pattern of decreasing air exchange rates up through the building (basement through second floor office).

Table 10-1. April/May 2011 Air Exchange Rate Measurement Results

Date Deployed	Date Collected	CAT ID	PMCH Amount (pl)	PDCH Amount (pl)	Location	Primary Tracer Deployed	Temperature (F)	Calculated AER 1/Hr	Volume Ft ³	Duration of Test Minutes
4/27/2011	5/4/2011	11015	30.74	127.51	422 basement	PDCH	61.29	0.74	4547	10368
4/27/2011	5/4/2011	8441	28.96	126.67	422 basement dup	PDCH	61.29	0.74	4547	10367
4/27/2011	5/4/2011	779	301.47	25.03	422 first	PMCH	67.82	0.56	9002	10364
4/27/2011	5/4/2011	9167	0	0	420 basement	None	58.17	NA	4547	10354
4/27/2011	5/4/2011	5273	0	0	420 first	None	61.19	NA	9002	10352
4/27/2011	5/4/2011	6963	0.75	0	Travel blank	None	68	NA	0	0

¹ Fan testing had ended on September 14 and resumed on October 6.

Section 10—Results and Discussion: Determine if observed changes in indoor air concentration of volatile organics of interest are mechanistically attributable to changes in vapor intrusion

Table 10-2. September 2011 Air Exchange Rate Measurement Results

Date Deployed	Date Collected	CAT ID	PMCH Amount (pl)	PDCH Amount (pl)	Location	Primary Tracer Deployed	Temperature (F)	AER 1/Hr	Volume Ft ³	Duration of Test Minutes
9/23/2011	9/29/2011	12621	406.42	28.96	422 office	PMCH	72.416	0.30	9002	8594
9/23/2011	9/29/2011	18744	253.51	38.35	422 first	PMCH	72.416	0.48	9002	8594
9/23/2011	9/29/2011	18185	5.94	108.79	422 basement	PDCH	67.77	0.82	4547	8591
9/23/2011	9/29/2011	9024	4.48	121.27	422 basement dup	PDCH	67.77	0.64	4547	8591

Measurements performed in April/May 2012 did not show any detectable crossover of either tracer into the 420 side of the duplex. The detection limit of the method is approximately 1 pl per sample and the lowest amount of tracer collected in one of the rooms with the emitters for that tracer present was 126 pl. So less than 1% of the tracer concentration detected in the 422 zones where it was released was present on the 420 side of the duplex.

The concentration of the tracer released in the basement (PDCH) was about 20% of the basement concentration on the first floor. The concentration of the tracer released on the first and second floors (PMCH) was detected at about 2% of the first floor concentration in the basement. These percentages suggest that during that measurement period more flow was up from the basement to the first floor, although some flow did come from the first floor down into the basement.

All of the measurements of air exchange rate are near the center of the range of Midwestern values compiled in EPA's *Exposure Factor Handbook* (U.S. EPA, 2011; **Table 10-3**).

Table 10-3. National Survey of Air Exchange Rates, Reprinted from the EPA Exposure Factor Handbook (U.S. EPA, 2011)

Summary Statistics for Residential Air Exchange Rates (in ACH ^a), by Region					
	West Region	Midwest Region	Northeast Region	South Region	All Regions
Arithmetic mean	0.66	0.57	0.71	0.61	0.63
Arithmetic standard deviation	0.87	0.63	0.60	0.51	0.65
Geometric mean	0.47	0.39	0.54	0.46	0.46
Geometric standard deviation	2.11	2.36	2.14	2.28	2.25
10th percentile	0.20	0.16	0.23	0.16	0.18
50th percentile	0.43	0.35	0.49	0.49	0.45
90th percentile	1.25	1.49	1.33	1.21	1.26
Maximum	23.32	4.52	5.49	3.44	23.32

^a ACH = Air exchanges per hour.

Source: Koontz and Rector, 1995, as cited in U.S. EPA (2011), Table 19-24.

10.2 Direct Differential Pressure Results—Are They Predictive of Indoor Air Concentrations by Themselves?

If:

- a. the concentration of VOCs or radon in subslab soil gas was constant,
- b. the size of the openings such as cracks into the basement was constant,
- c. indoor sources and ambient sources of VOCs were negligible, and
- d. the air exchange rate of the basement was constant,

then the flux of VOCs into the basement and the concentration of VOCs in the basement air should be directly related to the differential pressure. Compressible flow through an orifice (narrow opening, which likely describes a floor crack) is proportional to the square root of differential pressure as described by Bernoulli's Law (Lau, 2008). Of these conditions b. and c. are likely satisfied in this case, whereas a. and d. are likely to not be constant over time.

Differential pressures were collected for five pairs of locations as described in Section 3.6.6. Data for these locations are presented as **Figures 10-1** through **10-5**. The ambient barometric pressure measured at the house is shown as **Figure 10-6**. Most of the observed differential pressures show the greatest degree of variability and highest amplitudes (positive and negative) during the winter months (**Figures 10-1, 10-3, 10-4, and 10-5**). This variation is consistent with the pattern of the observed barometric pressures, which are moderate and stable during the summer and show greater fluctuation in other seasons (**Figure 10-6**).

Generally, the differential pressure from subslab to indoor air (**Figure 10-1**) on the 422 side of the duplex shows the existence of a driving force for vapor intrusion through most of the year. The maximum sustained magnitude of this differential pressure near 5 Pa is in close agreement with that observed in many residential structures observed for radon vapor intrusion (EPA, 1993b). The observed pattern where this driving force is lowest in July and August is broadly consistent with the pattern of VOC and radon indoor air concentrations (see Sections 5.1 and 5.2). The pressure differential on the unheated 420 side shows a qualitatively similar annual pattern (**Figure 10-5**) but with less magnitude in the fluctuations.

There is little differential pressure between the basement and upstairs (generally less than 1 Pa) (**Figure 10-2**). This low differential pressure is consistent with the relatively open plan of the structure and the absence of airtight vapor barriers between the floors. Thus, there is little resistance to flow vertically through the structure. The data points with differential pressures greater than ± 1 Pa are mostly attributable to depressurization of the basement during fan tests (as discussed in Section 12.2).

The differential pressure between deep and shallow soil gas is often among the highest differential pressures measured, relatively frequently reaching the upper and lower ranges of the sensor used (± 15 Pa) (**Figure 10-3**). This pressure difference indicates that a driving force for advective gas flow often exists between the 6- and 13-ft depths beneath the structure. This observation is at the outer edge of the predicted advective "zone of influence" of the structure that is part of a widely accepted conceptualization of the vapor intrusion process. This current understanding is well summarized in the *Users' Guide to the Johnson and Ettinger Model* (Environmental Quality Management, 2004):

... scenario where the source of contamination is incorporated in soil and buried some distance below the enclosed space floor. At the top boundary of contamination, molecular diffusion moves the volatilized contaminant toward the soil surface until it reaches the zone of influence of the building. Here convective air movement within the soil column transports the vapors through cracks between the foundation and the basement slab

floor. This convective sweep effect is induced by a negative pressure within the structure caused by a combination of wind effects and stack effects due to building heating and mechanical ventilation. It is also important to recognize that the advective zone of influence for soil gas flow is limited to soil immediately adjacent to the building foundation..... These results indicate that the advective zone of influence will likely be limited to a zone within 1 to 2 m of the building foundation.

However, it should be noted that:

- During some periods of the year, the 13-ft depth may have been below the water table, which would certainly bias the differential pressure measurement.
- Others have observed differential soil gas pressures in clusters of soil gas ports at substantial depths. For example, 2 cm of water differential pressure (196 Pa) is indicated at some times of day between the 6-ft and 74- and 84-ft ports in data presented by Forbes and coworkers. The southwestern site in question has a 6-in thick concrete slab (not necessarily a building) and a 90-ft thick vadose zone of basin fill alluvium. The authors interpret their data as showing barometric pumping down to the deepest depths with the deepest depths being attenuated and out of phase with the surface pressure cycle. Thus, they observe a reversal in flow direction between deep and shallow soil gas (Forbes et al., 1993).

The basement-to-exterior pressure differential shows a regular and substantial fluctuation (**Figure 10-4**) with some of the most extreme values in the winter seasons. This differential would be expected to be influenced by barometric pressure fluctuations in the atmosphere as well as the stack effect.

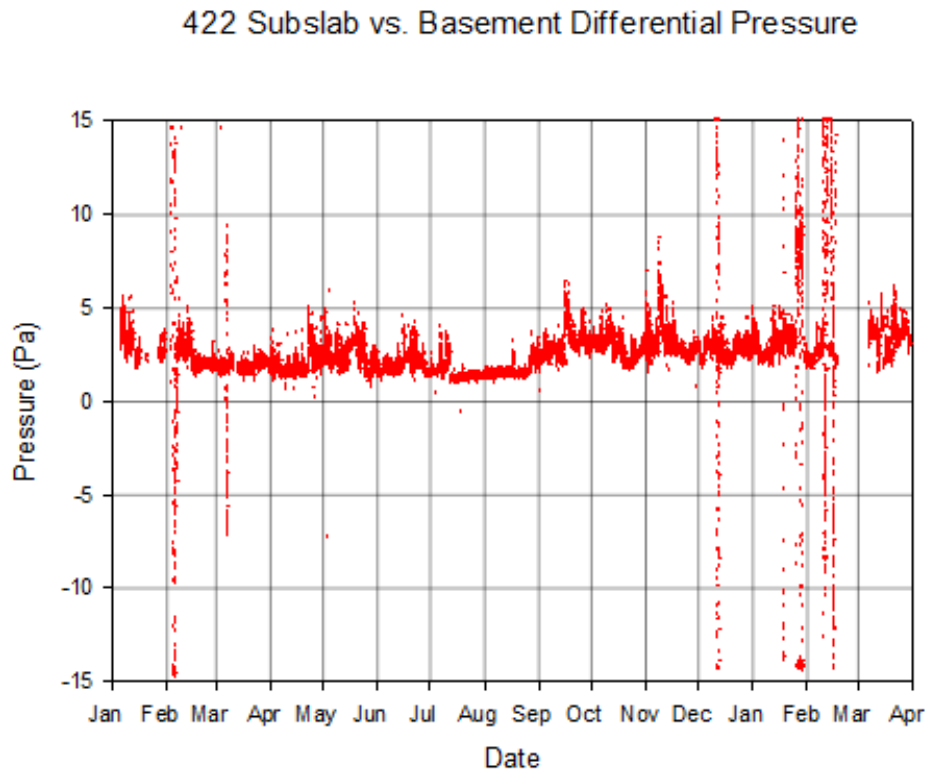

Figure 10-1. 422 subslab vs. basement differential pressure (positive values indicate greater pressurization of the subslab and thus flow toward the basement).

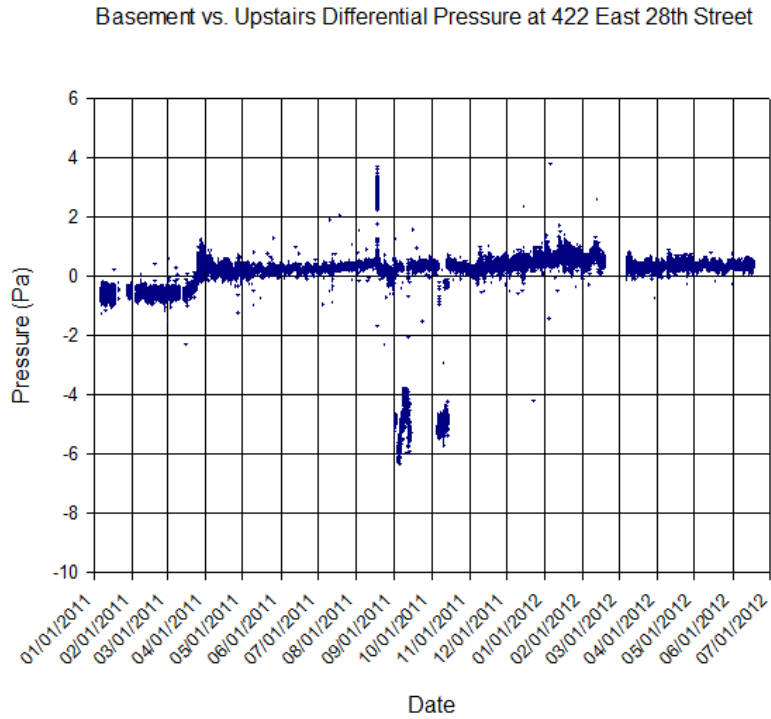

Figure 10-2. Basement vs. upstairs differential pressure (positive values indicate pressurization of the basement relative to the upstairs).

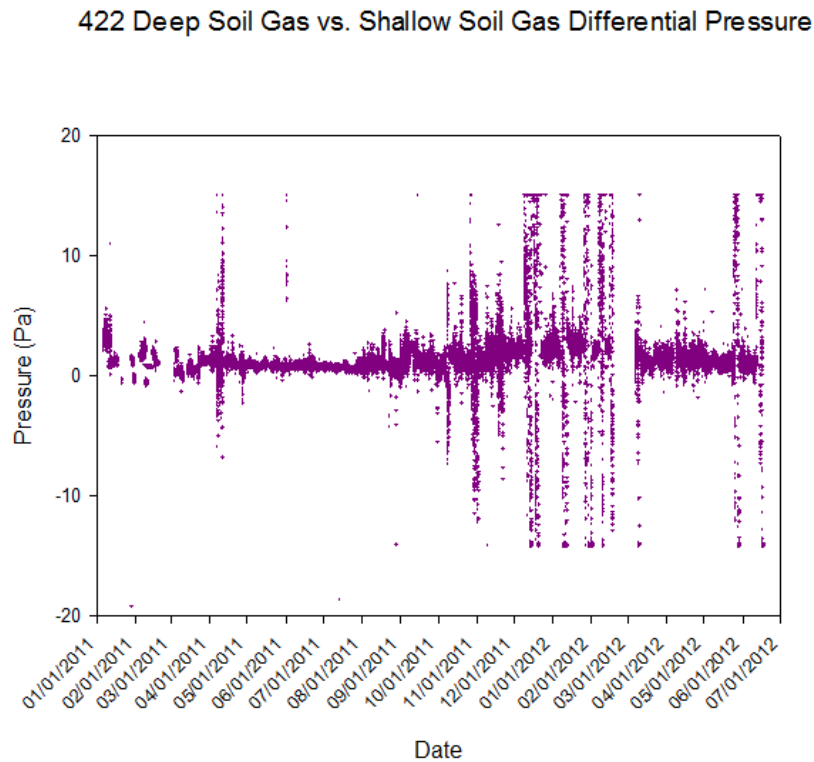

Figure 10-3. Deep vs. shallow soil gas differential pressure beneath 422 East 28th Street (positive values indicate a greater pressure in the deep soil gas relative to the shallow soil gas).

422 Basement vs. Exterior Differential Pressure 422

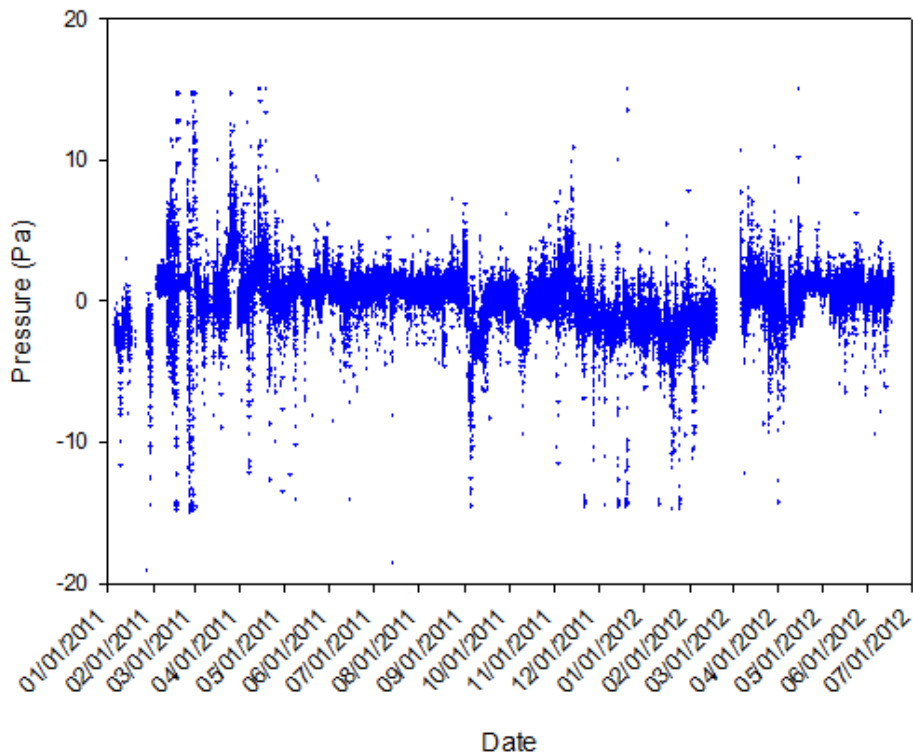

Figure 10-4. Basement vs. exterior (above grade) differential pressure at 422 East 28th Street (positive values indicate that the basement pressure is higher than the pressure in exterior air).

Section 10—Results and Discussion: Determine if observed changes in indoor air concentration of volatile organics of interest are mechanistically attributable to changes in vapor intrusion

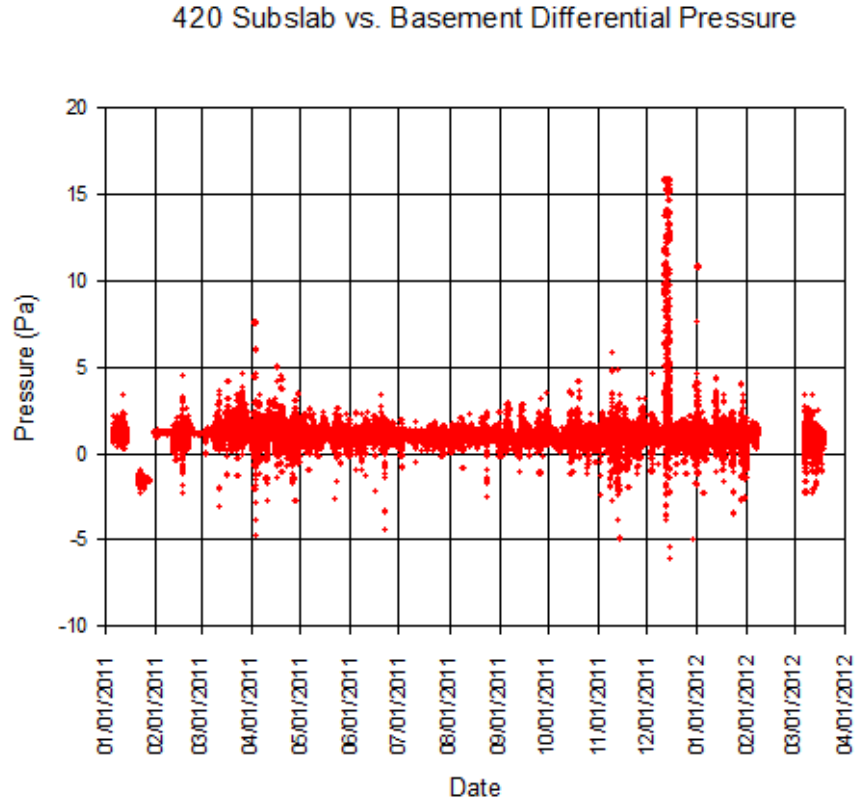

Figure 10-5. Subslab vs. basement differential pressure at 420 East 28th Street (positive values indicate higher pressure in subslab than in the basement, thus flow toward the basement).

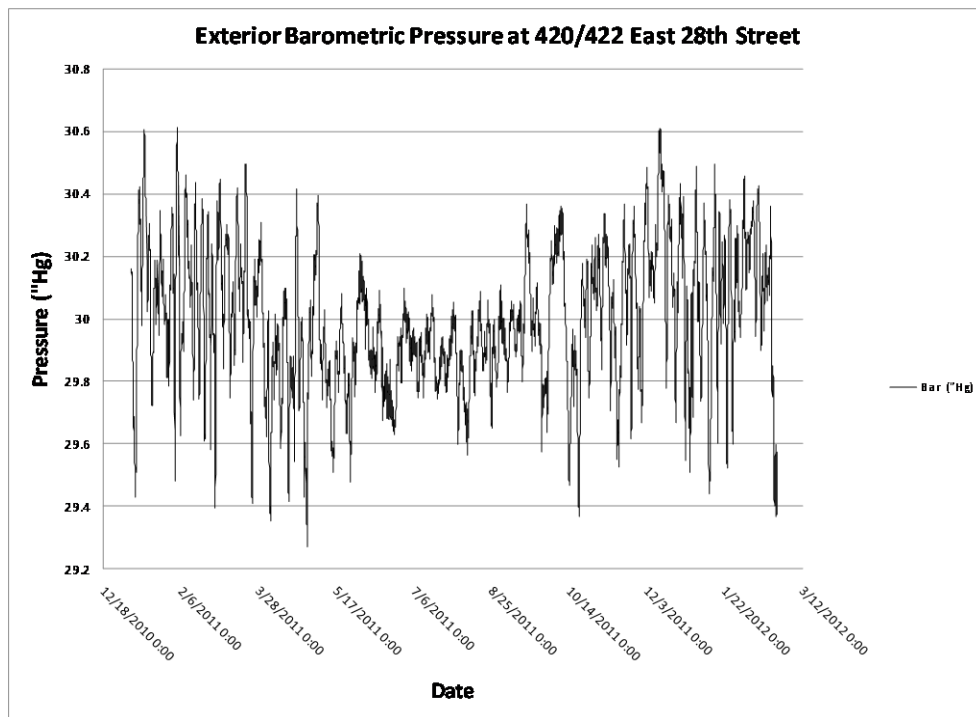

Figure 10-6. Exterior barometric pressure measurements over time, 420/422 East 28th Street.

10.3 Inferred Driving Force from Temperature Differentials—Is This Predictive of Indoor Air Concentrations by Itself?

To examine the stack effect as a potential driving force, we computed the predicted strength of the stack effect, based on an equation relating flow to the indoor/outdoor temperature differential from Dr. Sam C.M. Hui (1993):

3.3 Flow caused by thermal forces

If the building's internal resistance is not significant, the flow caused by stack effect may be estimated by:

$$Q = K \cdot A \cdot \sqrt{2 \cdot g \cdot \Delta h \cdot \frac{T_i - T_o}{T_i}} \quad \text{if } T_i > T_o$$
$$Q = K \cdot A \cdot \sqrt{2 \cdot g \cdot \Delta h \cdot \frac{T_o - T_i}{T_o}} \quad \text{if } T_o > T_i \quad (7)$$

where Q = air flow rate (m^3/s)
 K = discharge coefficient for the opening (usually assumed to be 0.65)
 A = free area of inlet openings (m^2)
 Δh = height from lower opening (mid-point) to neutral pressure level (m)
 T_i = indoor air temperature (K)
 T_o = outdoor air temperature (K)

We simplified this equation for purposes of plotting by taking only the variable portions:

$$Q \propto (T_i - T_o/T_i)^{1/2} \text{ or } Q \propto (T_o - T_i/T_o)^{1/2}$$

This quantity was then calculated for each 30-minute interval and then averaged over the 1-week period of operation of the passive samplers.

When we compare the calculated strength of the stack effect, we see that it is stronger and more variable on the heated side (**Figure 10-7**) than the unheated side (**Figure 10-8**) of the duplex. Although the stack effect is primarily associated in the VOC vapor intrusion field with winter conditions, the existence of a “solar stack effect” under summer conditions is well known and should not be ignored (University of Minnesota, 2008). As shown in **Figure 10-9**, there is a substantial cooling of ambient air at night in Indianapolis in the summer, but the building tends to hold heat because the windows were not being opened at night. Thus, it is not unusual to have a condition where the interior is 15° F higher than the exterior, allowing for a relatively strong stack effect. In this case, the windows could not be opened at night because the house was not staffed overnight; similar conditions are common in urban residences:

Section 10—Results and Discussion: Determine if observed changes in indoor air concentration of volatile organics of interest are mechanistically attributable to changes in vapor intrusion

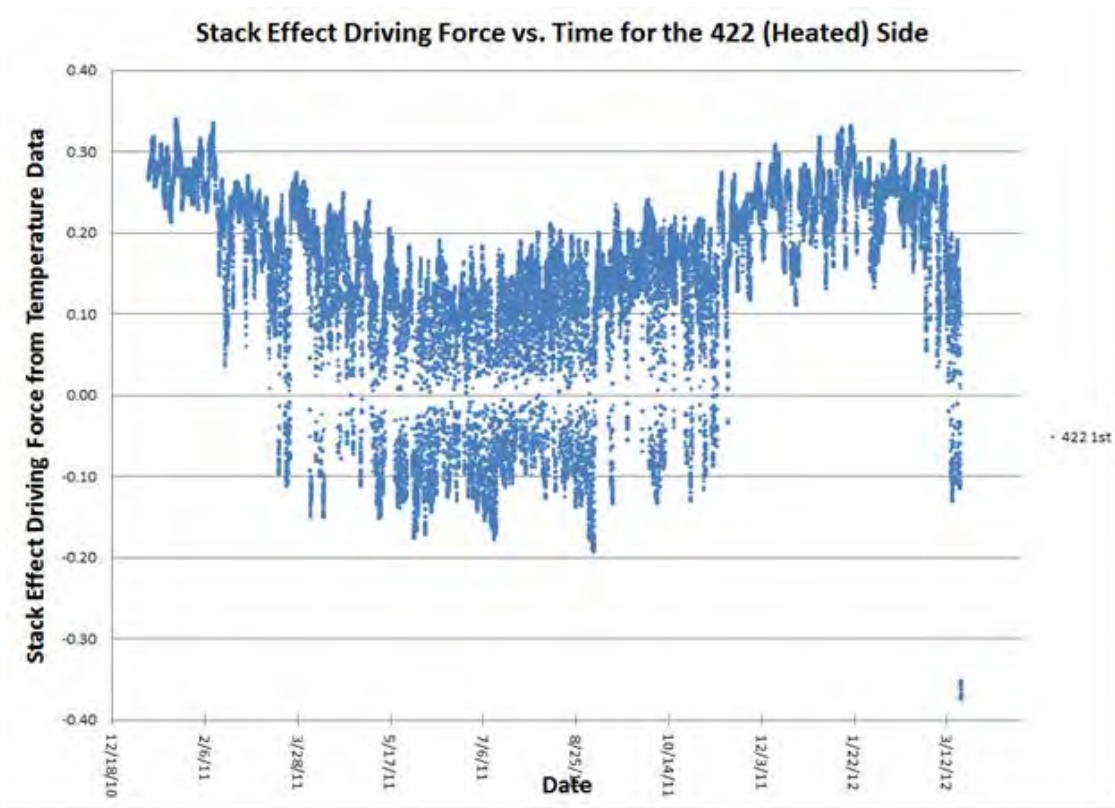

Figure 10-7. Stack effect driving force for 422 East 28th Street over time.



Figure 10-8. Stack effect driving force 420 (unheated) side over time.

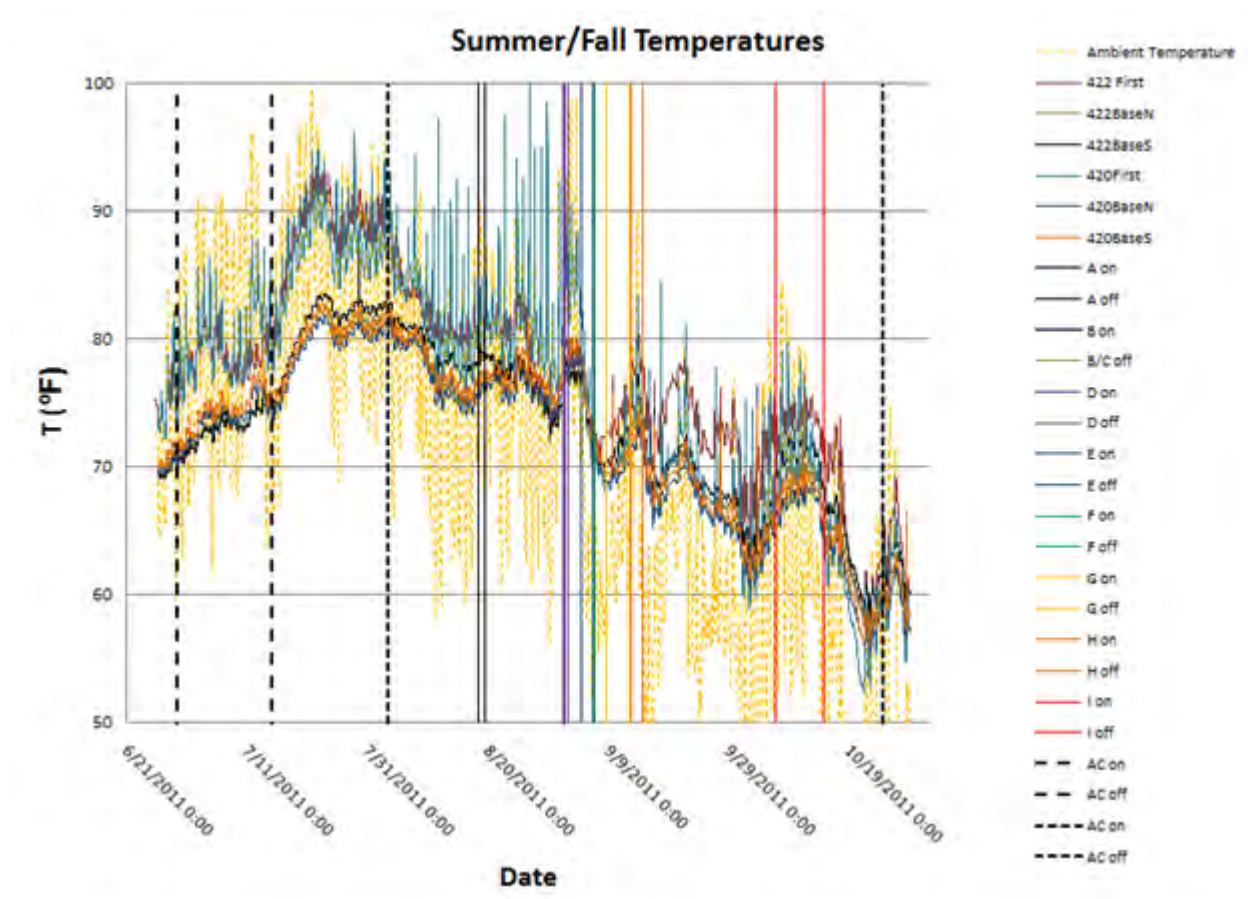

Figure 10-9. Summer and fall interior and ambient temperatures.

Brick and mortar buildings, asphalt streets, and tar roofs absorb daytime heat and slowly release it at night. Consequently, temperatures in urban areas can be warmer than rural areas by several degrees both day and night ... Socioeconomic factors also place urban residents under extra risk. Some people in cities do not have air conditioning, while people in high crime areas may be afraid to open their windows. (National Weather Service, 2012)

We then plotted the average strength of the stack effect over one week against indoor air concentrations of key contaminants. This analysis suggests that the strength of the stack effect explains some but not all of the variability in indoor concentrations we observed (**Figures 10-10** through **10-12**). PCE and chloroform indoor concentrations increase nearly exponentially with the computed stack effect driving force and appear linear on the semilog plots presented (**Figures 10-10** and **10-11**). Radon concentrations, in contrast, apparently increase linearly with computed stack effect driving force (**Figure 10-12**). Note on the radon plot that the first floor sampling locations on both sides of the duplex (red bordered data points in **Figure 10-12**) appear to overlay each other and lie below the trend of the basement data, as would be expected due to the greater dilution by outside air on the first floor.

PCE and chloroform also seem to show a greater concentration variability (scatter) than radon at higher stack effect driving forces. One possible interpretation of this higher scatter follows. The radon concentration in a horizontal layer under the slab is relatively uniform. The VOC concentrations under the slab within a

Section 10—Results and Discussion: Determine if observed changes in indoor air concentration of volatile organics of interest are mechanistically attributable to changes in vapor intrusion

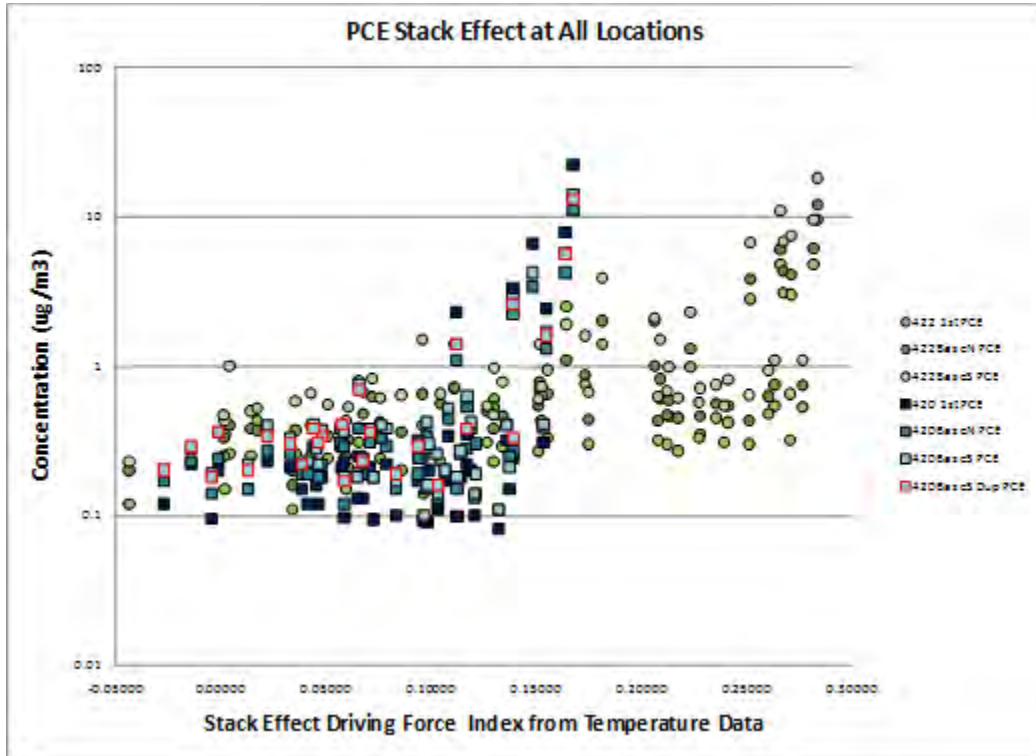

Figure 10-10. PCE concentrations in indoor air vs. stack effect driving force (log scale of concentration).

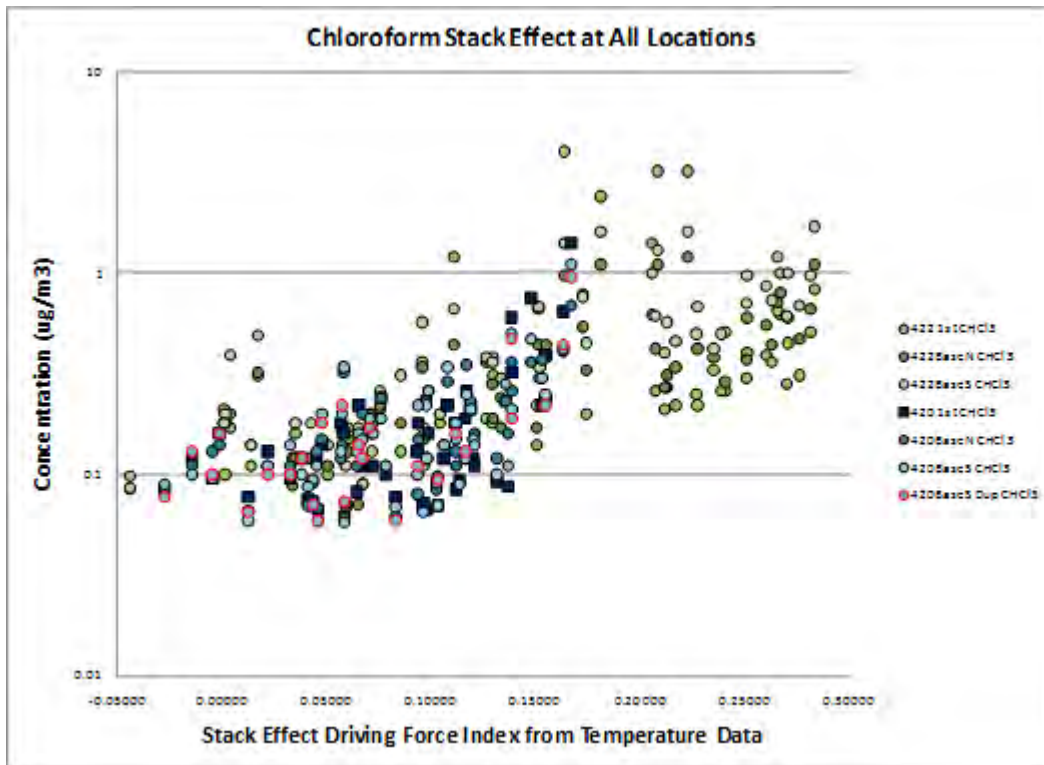

Figure 10-11. Chloroform concentrations in indoor air vs. stack effect driving force (log scale of concentration).

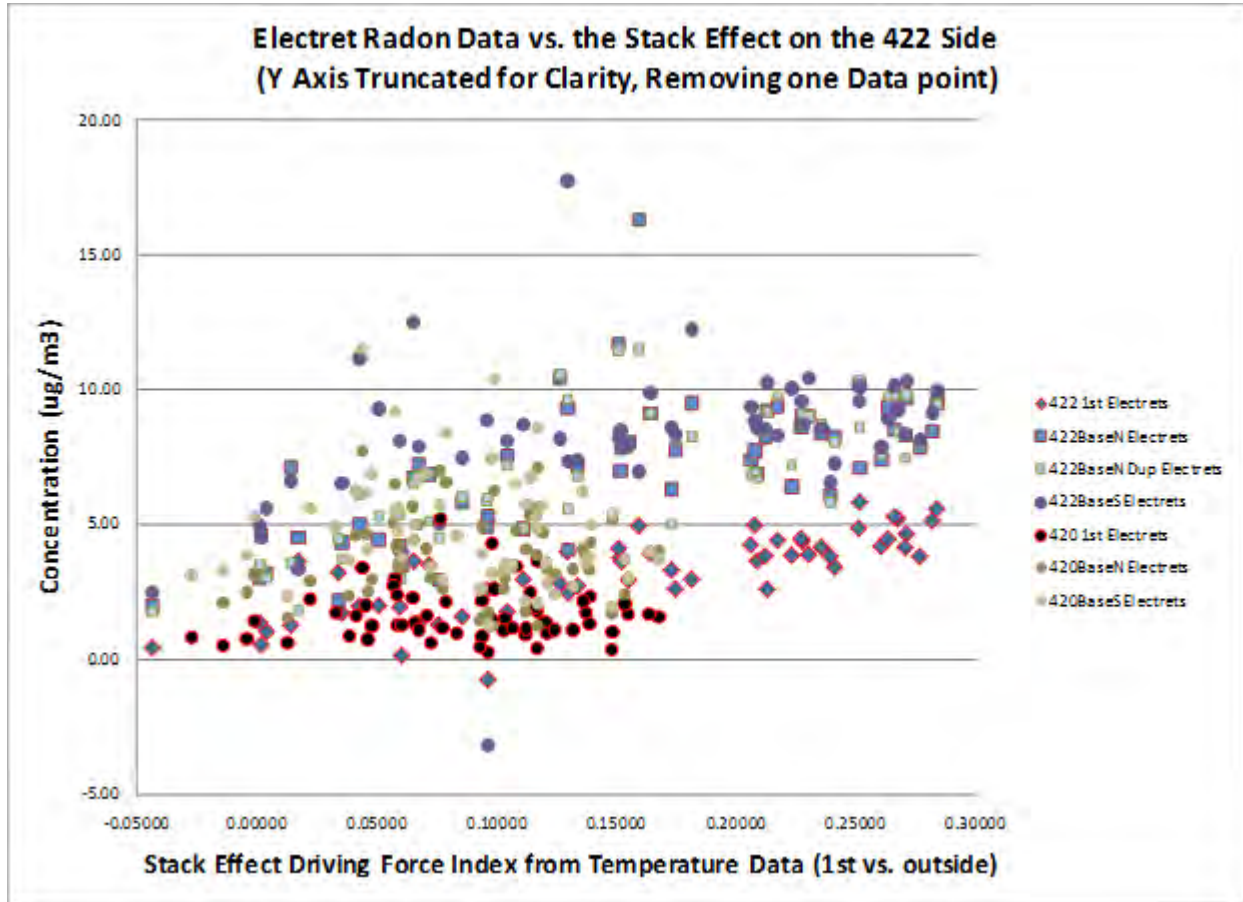

Figure 10-12. Radon concentrations (electret measurements) in indoor air vs. stack effect driving force.

horizontal layer are very uneven and the spatial pattern changes with time. The more uniform radon concentration is an expected result because most geological materials can generate at least some radon. Thus, the short half-life radon concentration is continually renewed. On the other hand, the more variable chlorinated VOCs have a relatively long half-life under aerobic conditions and can be shifted around in their spatial position between the slab due to wind effects (U.S. EPA, 2012a). The cracks and other points of entry to the foundation are probably unevenly distributed horizontally across the foundation. So the scatter at high stack effect flows could reflect that in some cases the VOCs are “in position” beneath the key cracks and sometimes they are “out of position” because of wind direction changes.

10.4 HVAC System Cycles

Recalling our objective D-1 “Identify any seasonal variations in VI fluxes in radon and VOCs as they relate to the use of HVAC in the home.” We can examine this effect using a number of timescales and data sets:

1. In Section 10.3, we calculated average stack effect driving force for 1-week sampling periods from calculations of the driving force made on half-hour intervals. Thus, we observed the effect of HVAC systems indirectly, because the HVAC maintained a temperature inside the 422 side of the duplex that was different from that experienced by an unconditioned structure (warmer in winter and cooler in parts of the summer).

2. We also directly measured the HVAC on/off cycles with 1-minute time resolution. This measurement was experimentally difficult to make, as well as to graph once the data were acquired. In **Figure 10-13**, we present one small time interval of the data, showing the following:
 - a. On this day, the thermostatically controlled HVAC system was going on and off rapidly—typically on for 6 or 7 minutes and then off for 6 to 8 minutes, repeatedly.
 - b. To avoid overloading the data system, the differential pressure sensor was set up to measure only once every 15 minutes as an instantaneous measurement.
 - c. Subslab vs. basement and basement vs. upstairs differential pressures were essentially flat over this 4-hour time interval.
 - d. The basement vs. exterior differential pressure had quite a bit of variability. However, that variability does not appear to be connected to the off or on status of the HVAC system.
 - e. This result is expected because the HVAC system, like most residential systems, is primarily recirculating air. Thus, the effects across the building envelope are probably controlled by temperature differentials and wind loads that operate on different timescales/cycles from the HVAC on/off. Therefore, we deprioritized further review of the HVAC system data on the scale of minutes.
 - f. We can also examine the effect on the HVAC system on a timescale of hours and days using a few inadvertent experiments. In Sections 5.2 and 5.4, we show the effects from the thefts of the window unit air conditioners (which occurred on July 13 and July 15, abruptly taking them out of service until replacement on August 2 and August 3).

We also observed sharp dips in temperature upstairs in the 422 side of the duplex from March 10 through March 16, 2011 and from December 18 through December 23, 2011 (**Figures 10-14** and **10-15**) associated with furnace breakdowns and repairs. Unfortunately the online gas chromatograph (GC) also went down on December 22, coming back into service on December 29. The decrease in the indoor-outdoor temperature differential (and thus stack effect driving force) that occurred when the heat was off from December 17 to December 23 appears to be associated with a decline in some of the VOC concentrations inside the house (**Figure 10-16**).

Section 10—Results and Discussion: Determine if observed changes in indoor air concentration of volatile organics of interest are mechanistically attributable to changes in vapor intrusion

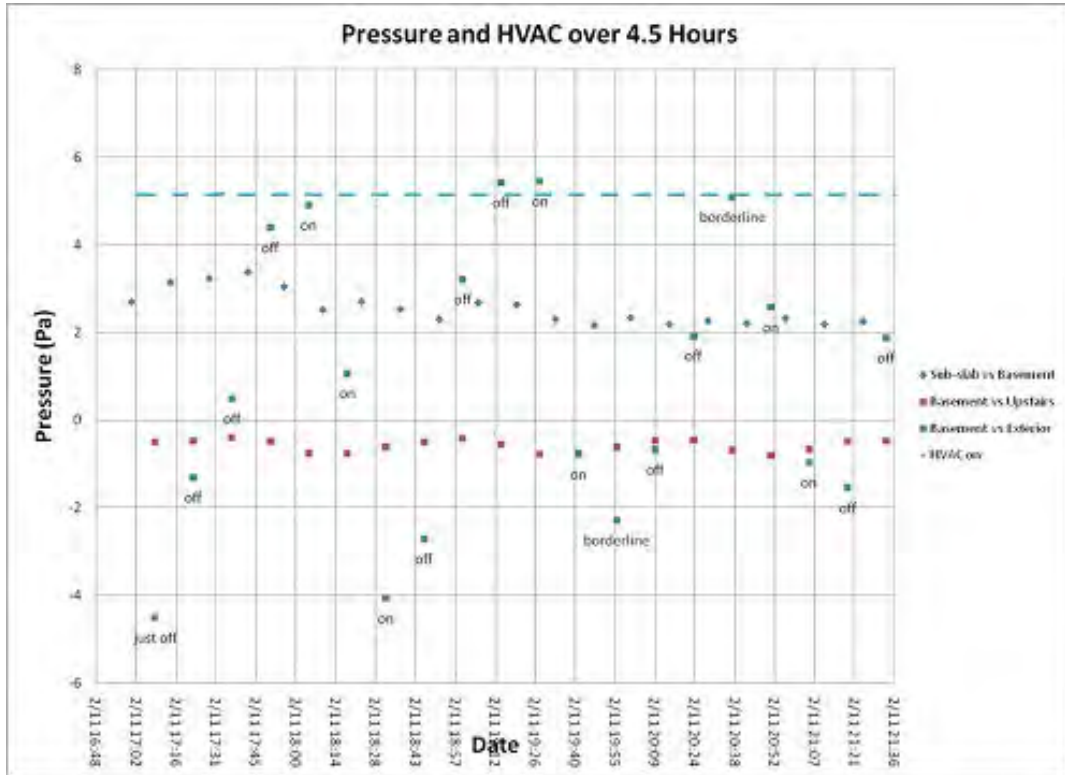

Figure 10-13. Differential pressure measurements graphed with HVAC system on/off cycles; HVAC system status at times when basement vs. exterior differential pressure was observed is annotated.

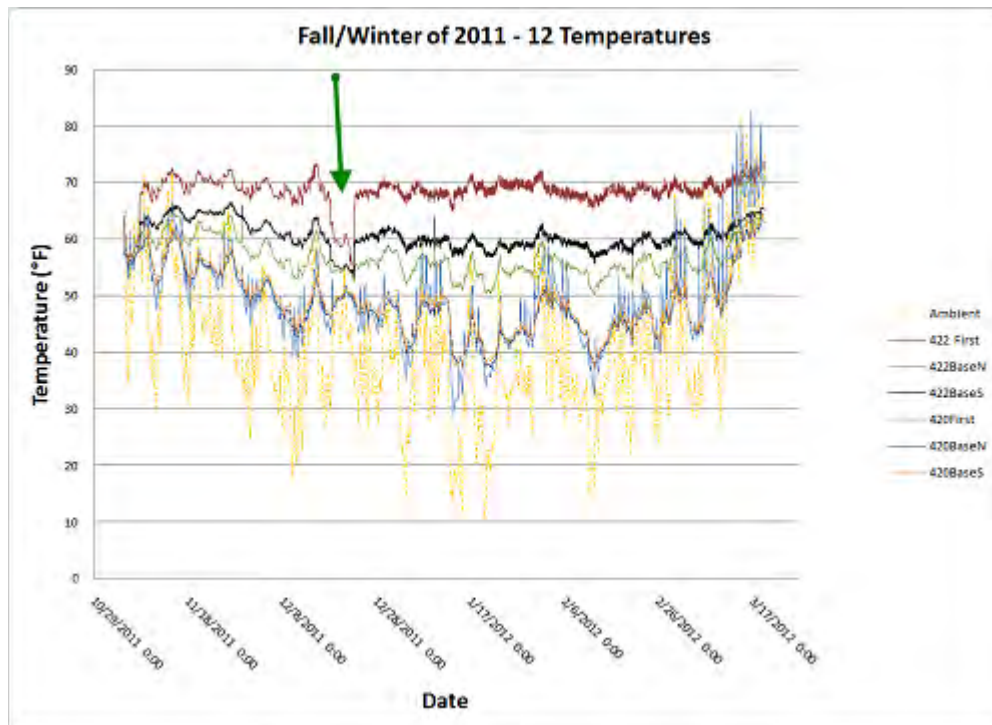

Figure 10-1. Selected period of indoor and ambient temperature data, green arrow marks December 18 to December 23 HVAC system outage.

Section 10—Results and Discussion: Determine if observed changes in indoor air concentration of volatile organics of interest are mechanistically attributable to changes in vapor intrusion

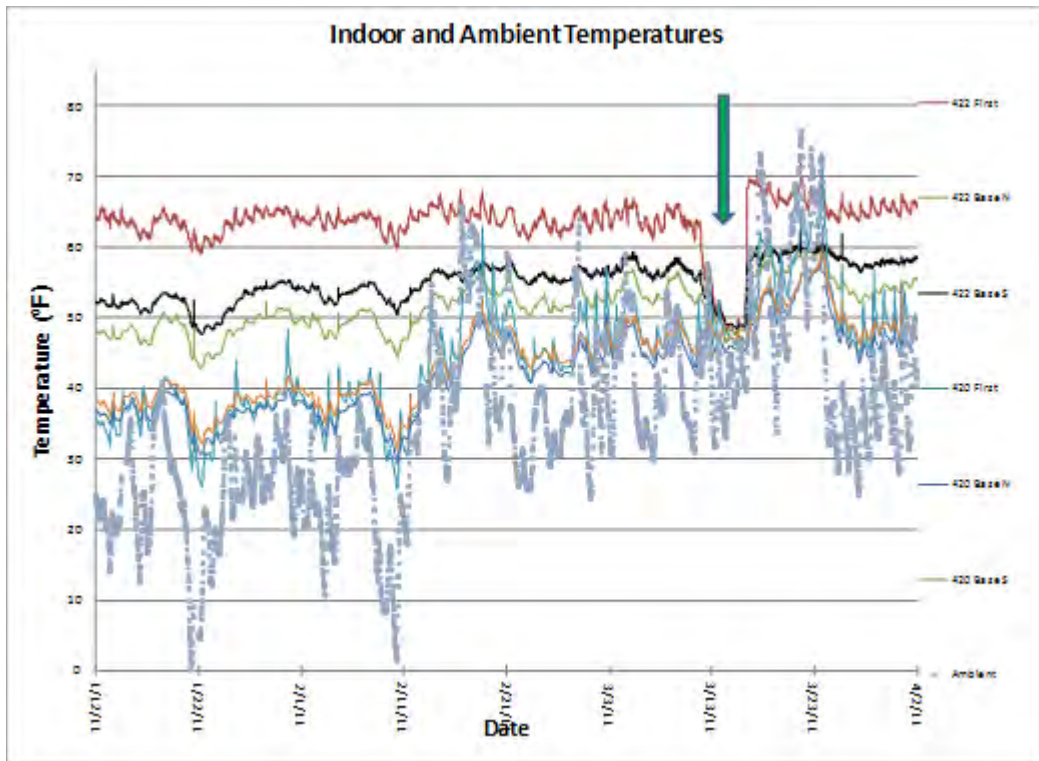

Figure 10-2. Selected period of indoor and ambient temperature data, green arrow shows March 11 to March 16 period of HVAC outage.

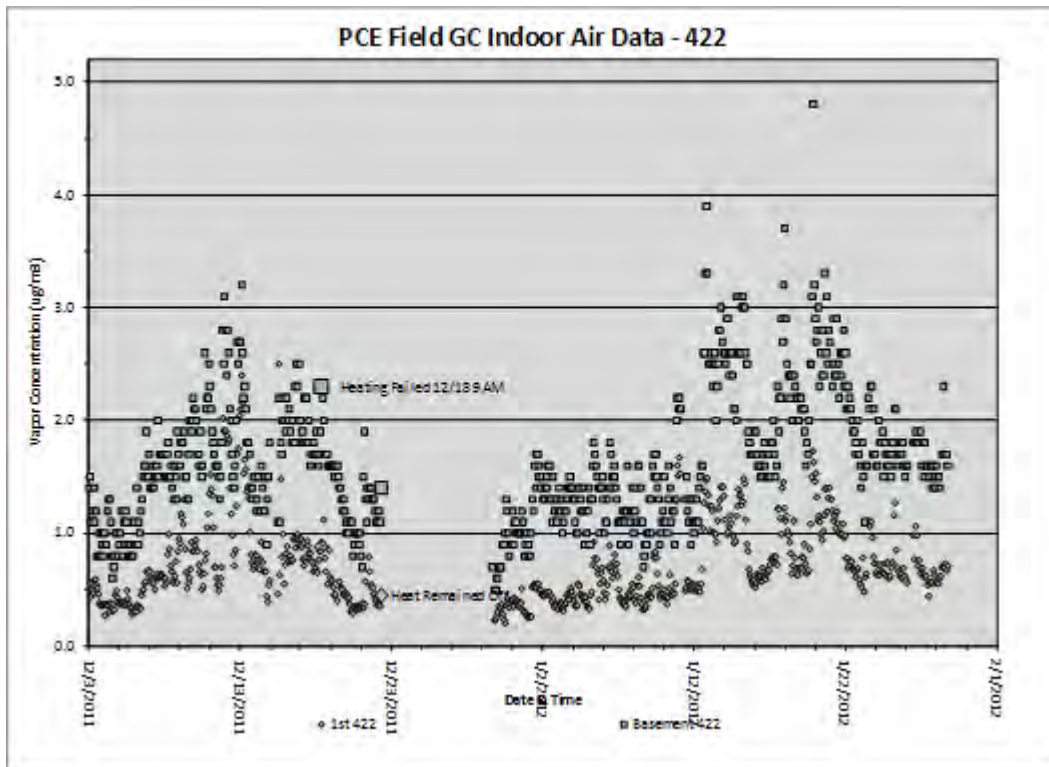

Figure 10-3. PCE, online GC data, 422 side, larger data points used to mark periods of heating system failure.

10.5 Trends in Subslab Concentration—Do They Predict Indoor Air Concentration Trends by Themselves?

There is substantial agreement in the patterns between the subslab data for certain ports and the indoor air concentrations. The port that shows the highest concentration of PCE and nearly the highest concentrations of chloroform observed (SSP-1) has the same pattern of high concentrations during the severe winter of 2010, declining to a minimum in the summer of 2010 and rebounding somewhat in the fall and winter of 2011 (compare figures in Sections 5.1.1 and 5.1.2). WP-3, also on the 422 (heated) side of the building, shows a similar trend. It is notable that this correlation occurs between the highest concentration subslab port and the highest concentration portion of the building interior. It is not known whether this observation is indeed predictive or merely coincidental because there is a lack of a similar correlation on the 420 side of the duplex. However, the magnitude of the changes is suggestive; for example, the decline in PCE between January and July 2011 is approximately 40x in both SSP-1 and 422 basement indoor air. Similarly, the decline between March and August is about 20x in both SSP-1 and 422 basement indoor air. The subslab concentrations seem to increase proportionally more between July 2011 and January 2012 than the approximate 2x increase of PCE seen in the 422 side indoor air. Similarly, the rise in indoor air of chloroform is about 8x from July to December 2011, whereas the rise in subslab chloroform was substantially greater (approximately 20x).

10.6 Do Trends In Shallow and Deep Soil Gas Predict Indoor Air Concentrations?

As noted in Section 5.1.3, a seasonal pattern with higher concentrations in winter and lower concentrations in summer was also noted in certain soil gas sampling locations further away from the slab. For chloroform, this seasonal pattern can be discerned in deep external soil gas SGP5-13 (**Figure 5-19**), SGP6-9 (**Figure 5-21**), SGP7-13 (**Figure 5-23**) as well as deep soil gas beneath the slab such as SGP8-9 (**Figure 5-25**), SGP9-9 (**Figure 5-25**), SGP10-13 (**Figure 5-27**), and SGP11-13 (**Figure 5-29**). This pattern clearly cannot be due to temperature, because temperatures at these depths would be expected to be relatively stable, and the concentration of VOCs in the vapor phase would be expected to increase with increasing temperature. However, this trend could reflect the following:

- lower groundwater levels in summer (and thus a greater distance between the presumed source of VOCs and the sampling point allowing greater attenuation), and/or
- the reduced driving force from the stack effect in summer (see Figures 10-7 and 10-8 in Section 10.3) inducing less flow upward, and thus allowing greater attenuation/dilution.

These seasonal soil gas concentration changes in chloroform are about 1 order of magnitude and, thus, slightly smaller in magnitude than the changes observed in indoor air (see Section 5.1.1). However, because the magnitude of the driving force for soil gas entry is also decreasing, the effect of lower soil gas concentrations would be expected to be compounded by reductions in volumetric flux into the structure (Section 10.3). In order to prove that these soil gas concentration changes are indeed causing the observed changes in indoor air, it would be necessary to know whether the portions of the subslab soil gas that exhibit this seasonal trend account for a significant proportion of the soil gas VOC flux into the building. In later studies we will attempt to determine the impacts of seasonal trends in soil gas through tracer testing and pumping tests.

A similar seasonal pattern is seen occasionally in PCE: SGP1-16 (**Figure 5-12**), SGP6-9 (**Figure 5-22**), and SGP9-9 (**Figure 5-26**) (see Section 5.1.3). The physical causes of these trends could be similar to those for chloroform. However, because these seasonal patterns in soil gas for PCE are less frequent and clear, the case for them being causative of the observed trends in indoor air PCE is weaker.

10.7 Ambient Concentrations—Are They Significant?

The data presented in Sections 5.1.1 through 5.1.3 show that ambient concentrations are consistently among the lowest measured for chloroform and PCE. Ambient concentrations of PCE and chloroform observed at this site are relatively uniform with time, whereas indoor concentrations display a strong seasonality. A concentration comparison suggests that the only situation in which the ambient concentration appears to dominate indoor air for PCE and chloroform is for the 420 first floor during summer.

10.8 Potentiometric Surface/Water Levels—Do They Predict Subslab Concentrations?

As shown in **Figure 10-17**, there is a close correlation between the observations of rainfall at the duplex, rises in the nearby creek, and increases in the groundwater table beneath the duplex. It is not known whether this rise in the water table reflects the influence of leakage from the nearby combined sewers (**Figure 10-18**) or an indirect potentiometric effect from the influx of creek water into the shallow aquifer.

Other than the early September and early October weeks that were affected by the fan tests (discussed in Section 12.2), the peak indoor air concentrations of chloroform on the 422 side of the duplex peaked in March and mid-December 2011 (see Section 5.1.1). Although these months were periods of relatively high stack effect driving force, they do not correspond closely to the maxima of the stack effect driving force calculation that occurred on approximately January 15, 2011, and January 15, 2012 (see Section 10.3). These chloroform maxima do exactly correlate; however, to significant storm events recorded in the U.S. Geological Survey (USGS) discharge records of the nearby Fall Creek as well as in the rainfall and depth to groundwater data sets. Coincidentally, these maxima also corresponded to our first and third intensive rounds, which were scheduled well in advance, on the basis of anticipated temperatures (not rainfall). Although it is not as crisp a correlation, there is some evidence of chloroform reaching maxima in the highest concentration subslab ports (SSP-1 and SSP-4 beneath the 422 side) in March and December 2011 as well (see Section 5.1.2).

In contrast, the maximum PCE concentrations in 422 indoor air occurred in mid-January 2011 and mid-January 2012 (see Section 5.1.1). These maxima in PCE do appear to coincide with the stack effect driving force estimate derived from temperature data (Section 10.3). These two January maxima are also visible in the plot of the highest concentration subslab PCE port beneath the 422 side (SSP-1, Section 5.1.2). The PCE behavior on the 420 side appears significantly different—it declines more rapidly in January 2011 and reaches its next maxima earlier—in late November or early December (Section 5.1.1).

The chloroform behavior on the 420 side is also different from the behavior on the 422 side. Chloroform also declines more rapidly on the 420 side than the 422 side. Chloroform shows three maxima that are not related to the September/October fan testing—January 15, March 31, and December 15, 2011. The latter two maxima come at the end of significant storm events recorded in the nearby Fall Creek.

Section 10—Results and Discussion: Determine if observed changes in indoor air concentration of volatile organics of interest are mechanistically attributable to changes in vapor intrusion

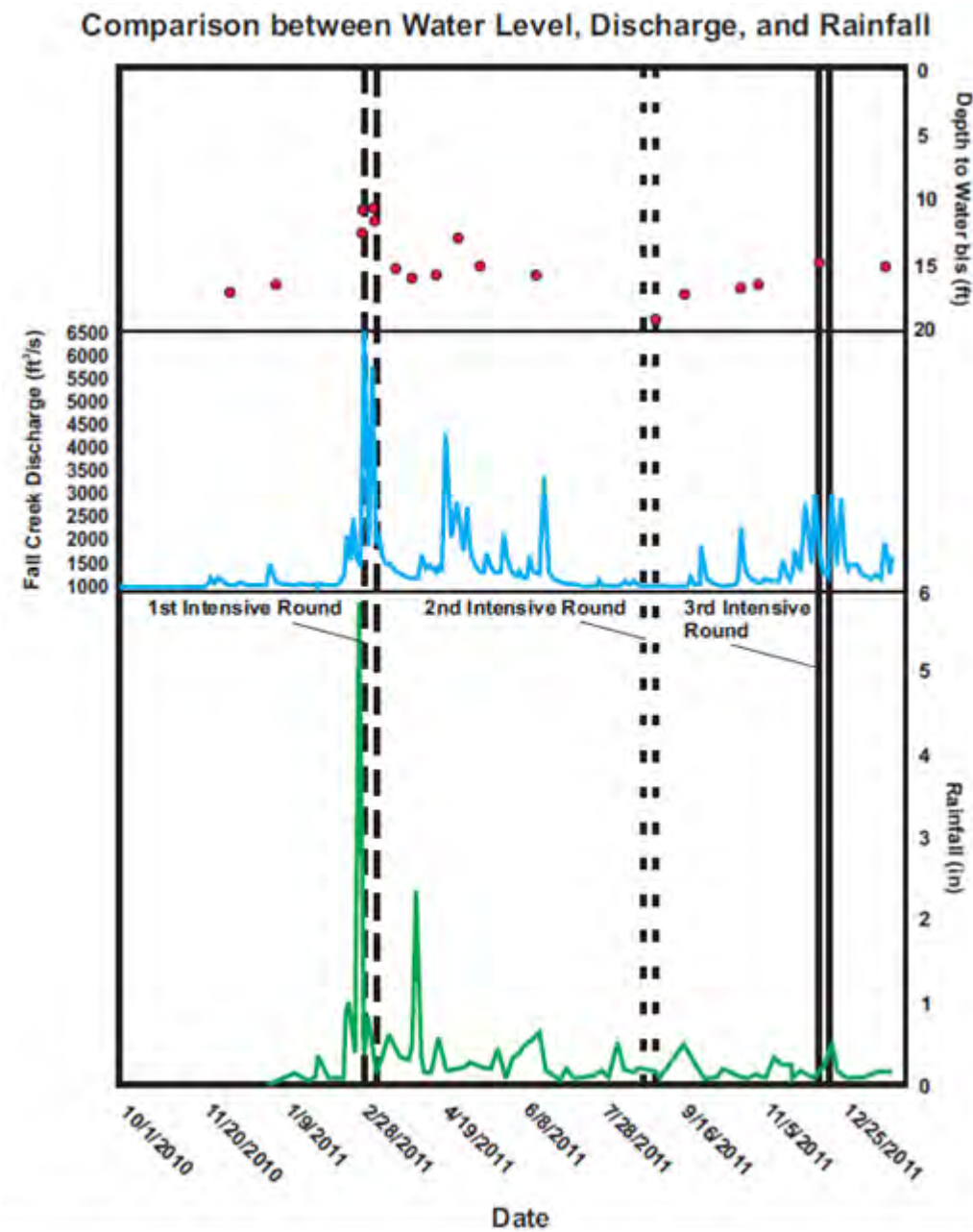

Figure 10-17. Average depth to water at house, discharge of nearby creek (USGS) and rainfall at house compared (intensive sampling rounds shown with vertical lines).

420 E. 28th St, Indianapolis, IN

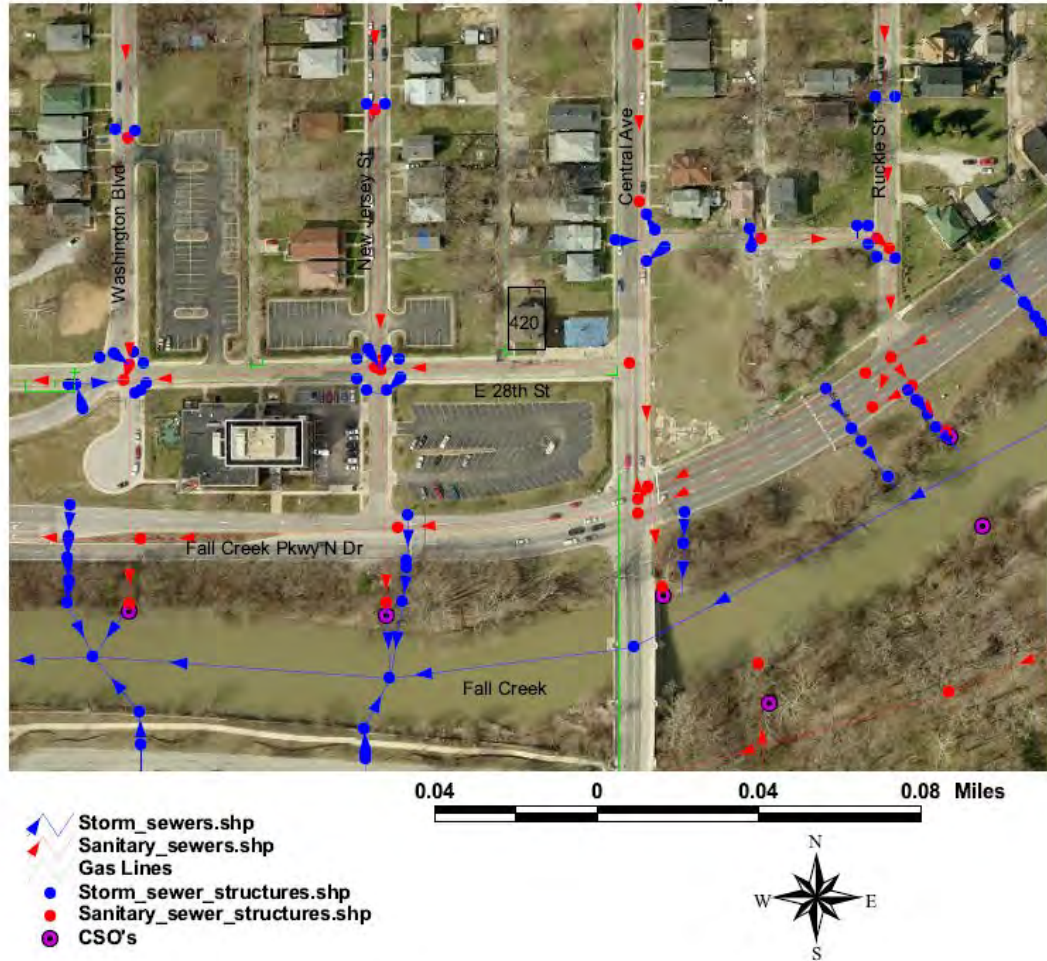

Figure 10-18. Storm and sanitary sewers near the test duplex at 420/422 East 28th Street.

In summary, it appears that

- chloroform trends in indoor air visually correlate with hydrogeology/storm events,
- PCE trends in indoor air more closely correlate with the stack effect driving force, and
- soil gas data suggest that both chloroform and PCE concentrations peak just above the water table.

Although our data analysis is ongoing, we have several potential explanations for the temporal trends observed in this data set:

- A sewer gas odor was noted on the first floor of the duplex on approximately April 1, 2011, and was traced to a floor drain in the first floor laundry room on the 422 side (**Figure 10-19**). All drains and fixtures except those in the basement necessary for the continued operation of the furnace were sealed as of May 10, 2011. This sewer gas pathway is not considered to be a major source to indoor air, because neither the appearance of this odor nor the sealing of the drains coincided with a significant inflection point in the overall indoor air time series (Section 5.1.1). However, it is probable that this entry route contributed to the higher indoor air concentrations of chloroform observed on the first floor than in the basement in March 2011.

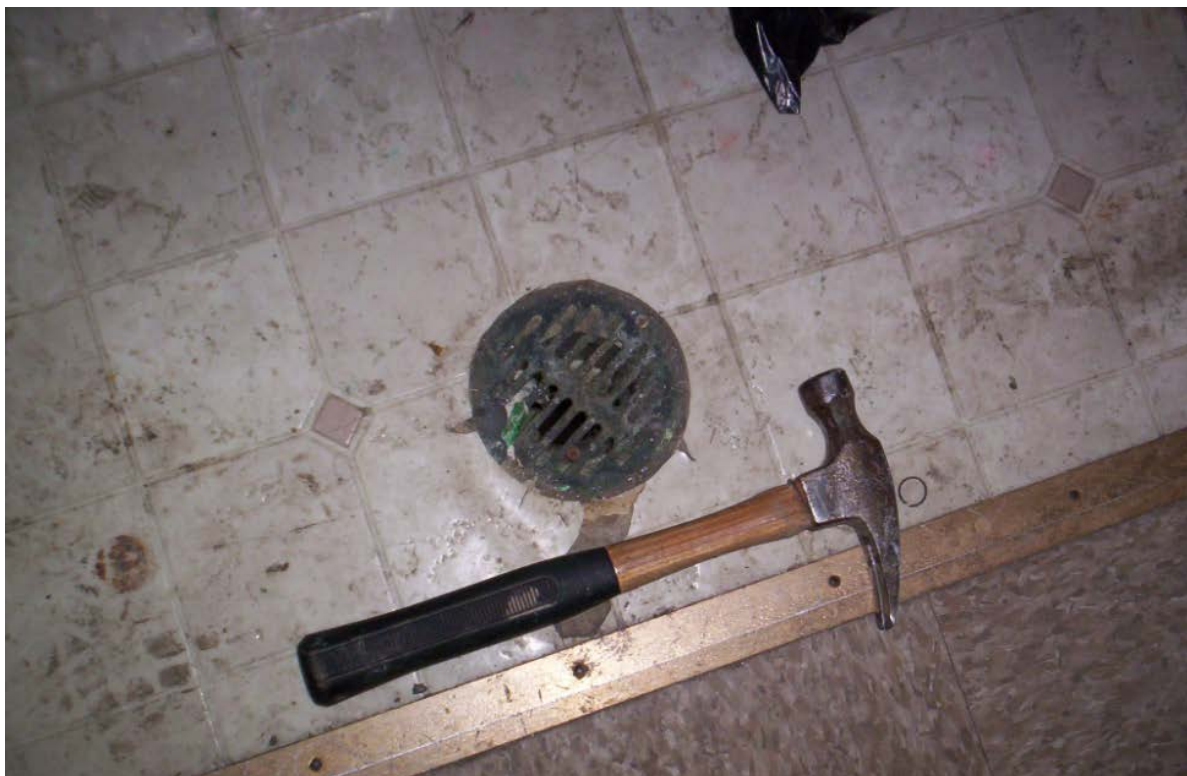

Figure 10-19. Floor drain in first floor laundry room on 422 side of duplex.

- Direct samples of sewer gas with Radiello samplers were collected in late April and are summarized in **Table 10-4**. The observed ratios of PCE/chloroform and PCE/TCE also support the conclusion that the first floor drain route is not a controlling factor on concentrations other than chloroform on the 422 first floor.
- Only one sample had concentrations high enough to be credible as a significant source of VOCs for a large area—the 422 laundry room drain that was also the location of our “sewer gas” odor observations. Surprisingly, the concentrations in that drain were almost exactly the same for chloroform and PCE—around $300 \mu\text{g}/\text{m}^3$, which is not the expected result of a nonspecific reaction between bleach and natural organic matter, which is a primary source of chloroform in most sewers (Odabasi, 2008; Whitmore and Corsi, 1994; Hass and Hermann, 1998). Nor is it what one would expect from Indianapolis city drinking water passing through use and on into the sewers or leaking from water mains down into underlying sewer pipes. PCE was found in only 1 of 74 samples of Indianapolis drinking water at a concentration of 0.53 ppb. Chloroform was found in 67 of 73 Indianapolis drinking water samples at an average concentration of 18.9 ppb (see **Table 10-5**). The drinking water shows a set of products typical of disinfection by-products, including trihalomethanes and haloacetic acids.

Section 10—Results and Discussion: Determine if observed changes in indoor air concentration of volatile organics of interest are mechanistically attributable to changes in vapor intrusion

Table 10-4. Drain Sampling Data April 13–April 21, 2011 ($\mu\text{g}/\text{m}^3$)

Location	Chloroform	TCE	PCE	Ratio PCE/Chloroform	Ratio PCE/TCE
Trip blank	ND	ND	ND	--	--
Field blank	ND	ND	0.011	--	--
Ambient	0.064	0.039	0.14	2.19	3.59
422 basement S	0.68	0.097	1.4	2.06	14.43
422 basement N	0.44	0.061	0.78	1.77	12.79
422 first floor	0.66	0.061	0.7	1.06	11.48
420 basement S	0.17	0.043	0.36	2.12	8.37
420 basement N	0.2	0.038	0.31	1.55	8.16
420 first floor	0.18	0.028	0.21	1.17	7.50
422 laundry drain in floor	320	5.6	310	0.97	55.36
422 bathroom—in sink	1.2	0.089	1.4	1.17	15.73
422 basement floor drain (near furnace)	0.65	0.091	1.7	2.62	18.68
420 bathroom—in sink	1.5	0.054	0.96	0.64	17.78
420 laundry room drain in floor	1.6	0.087	2.6	1.63	29.89

ND = no data

Table 10-5. NY Times Database Report on Indianapolis Drinking Water Showing Relative Concentrations of PCE and Chloroform

Contaminant	Average Result	Maximum Result	Health Limit	Legal Limit	Number of Tests			
					Total	Positive Results	Above Health Limit	Above Legal Limit
Contaminants above legal limits								
Total haloacetic acids	36.58 ppb	87	70	60	44	44	2	3
Total trihalomethanes	33.56 ppb	107.8	—	80	111	105	0	1
Contaminant below legal limits, but above health guidelines								
Tetrachloroethylene	0.00 ppb	0.53	0.06	5	74	1	1	0
Contaminants found within health guidelines and legal limits								
Chloroform	18.90 ppb	81.7	70	80	73	67	0	0
Chloromethane	0.01 ppb	0.74	30	—	73	1	0	0

Source: *New York Times*, 2012

- These data suggest that the gas in the floor drain on the first floor of 422 was probably influenced by a location-specific source of PCE. This could reflect migration of PCE in soil or groundwater through the sewer's acting as a preferential pathway for vapor intrusion. Alternately, PCE could be present as a free product in low points of the sewer system from previous residential, commercial, or industrial uses. Similar pathways have been observed at other locations with vapor intrusion issues (Distler and Mazierski, 2010).
- Referring back to the indoor air trends discussed in Section 5.1.1, this sewer gas with an even ratio of chloroform and PCE cannot be the primary driver of the indoor concentrations because PCE is highest in week 1 and declines steadily through July, whereas chloroform has a distinct peak in weeks 7 through 10 on the 422 first floor.

Table of Contents

11. Results and Discussion: Do groundwater concentrations control soil gas concentrations at this site? And thus indoor air concentrations?	11-1
11.1 Potentiometric Surface Changes (and Correlation to Local Surface Water Bodies).....	11-1
11.2 Groundwater Concentration Trend.....	11-5
11.2.2 Is the Groundwater Concentration Trend Correlated to Potentiometric Surface?.....	11-8
11.2.3 Is the Groundwater Concentration Trend Correlated to Indoor Air Concentrations?.....	11-8
11.3 Soil Moisture Trends	11-8
11.3.1 Correlation with Rainfall Measurements	11-8
11.3.3 Relationship to Observed Stratigraphy.....	11-9
11.4 Correlation of Groundwater Concentration Changes to Deep Soil Gas	11-11
11.5 Revisions to Conceptual Site Model	11-14

List of Figures

11-1. Stacked graph presenting depth to water in feet (top—red circles), discharge at Fall Creek in ft ³ /s (middle—blue line), and rainfall in inches (bottom—green line).	11-2
11-2. Monitoring well water data for PCE versus time.....	11-6
11-3. Flooded SGP water data for PCE versus time.	11-7
11-4. Soil moisture: irrometer moisture data in centibars for the interior and exterior of the 422/420 house.	11-10
11-5. Lithological fence diagram showing some of the major soil types beneath the 422/420 house.	11-10
11-6. Lithological fence diagram showing some of the major soil types beneath the 422/420 house.	11-11
11-7. PCE concentrations at each of the SGP1 ports over time.	11-12
11-8. PCE concentrations at each of the SGP2 ports vs. time.....	11-12
11-9. PCE concentrations at each of the SGP5 ports over time.	11-13
11-10. PCE concentrations at each of the SGP6 ports over time.	11-13
11-11. PCE concentrations at SGP8 and SGP9 ports over time.	11-14
11-12. Temporal plot of log indoor air concentration for VOCs (µg/m ³) and radon (pCi/L) by sample location over the study period.	11-16

List of Tables

11-1. External Soil Gas Locations and Their Flooded Status during Different Times	11-3
11-2. Internal Soil Gas Locations and Their Flooded Status during Different Times.....	11-4
11-3. Groundwater Monitoring Well Information.	11-5

11. Results and Discussion: Do groundwater concentrations control soil gas concentrations at this site? And thus indoor air concentrations?

11.1 Potentiometric Surface Changes (and Correlation to Local Surface Water Bodies)

Figure 11-1 presents in a stacked representation the relationship between depth to water readings taken at the 422/420 house, Fall Creek discharge, and the rainfall taken at the house for the duration of the project. The most noticeable feature is that the highest degree of rainfall occurred in early March 2011. This feature was immediately reflected in the discharge at Fall Creek and in the decreasing depths to water at that time. Note that multiple depth readings were taken in early March because of the coincidence of the heavy rain with the first intensive sampling round. The hotter months appear to be the drier, with the spring and fall being some of the wetter months.

The water table had been expected to be at about 17 ft, just under the deepest of the soil gas ports (16.5 ft). However, 2011 appears to have been a wetter than average year, resulting in the water table at about 15 ft bls for most of the project. There was a particularly dry period in the area from August until October 2011, which allowed many of the 16.5-ft depths to be sampled again for a brief period (see **Tables 11-1** and **11-2**). The intensive rounds can be seen on **Figure 11-1**, indicated by the vertical dashed and solid lines. The first intensive round happened to occur during the wettest period of the whole project. The second intensive took place during one of the drier periods of the project. Stream discharge had increased toward December, and by this time, the 16.5-ft depths were nonfunctional (see **Figure 11-1**).

For the most part, all three sections of the stacked graph match well indicating a rapid connection between precipitation, surface water levels, and groundwater levels. The first large peak has the closest match between these three parameters. A rainfall peak in March seems to have a time delayed relationship to similar peaks in the discharge and water depth graphs. All three parts of the stacked graph reflect the drier period well. However, a series of peaks on the stream discharge figure in December correspond to the groundwater depth graph, but with only a small peak on the rainfall graph (**Figure 11-1**). These December observations suggest a regional rainfall event in the catchment of Fall Creek not recorded as substantially at the house. In the Indiana weather data, Central Indiana was 2.10 inches above normal rainfall levels for the month of December (see Table 5-3 in Section 5.5).

Tables 11-1 and **11-2** show recorded dates or date ranges when soil gas ports external to the house (**Table 11-1**) and internal (**Table 11-2**) would not pump (WP) presumably because of saturated soils or contained visible water in their lines (WIL). Red lettering indicates dates during the first intensive round (the wettest time during the project as indicated in **Figure 11-1**). Nearly every external soil gas port was at some time unable to pump or had water in the line, but some had blockages more frequently and a few never operated again after a blockage occurred. Almost all of the recorded blockages occurred between January 25, 2011, and May 25, 2011, with only a few occurring afterward (see **Tables 11-1** and **11-2**). Many of the dates when blockages occurred coincided with the high water levels and rains during the first intensive round, but this could also have been a result of checking the ports multiple times per day or week. We interpret these observations of water in lines or points that would not pump as indicating infiltrating precipitation.

Ports SGP5-6, SGP6-3.5, and SGP7-6 were unusable from the beginning of the March intensive round through late May 2011. All 13-ft depths were unusable during the intensive round but became usable and were used in place of the original plan of frequent sampling from the 16.5-ft depths shortly after (see **Table 11-1**).

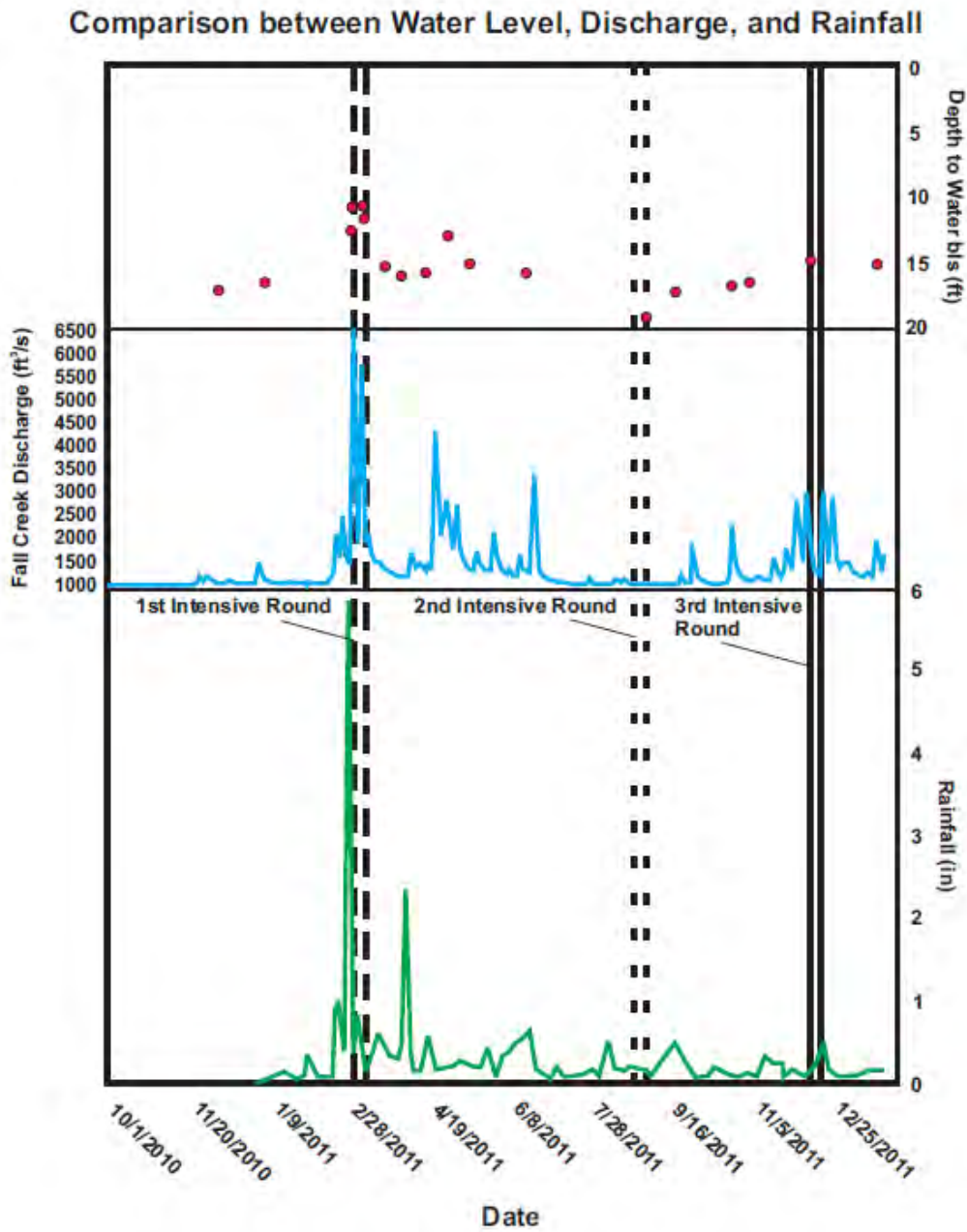

Figure 11-1. Stacked graph presenting depth to water in feet (top—red circles), discharge at Fall Creek in ft^3/s (middle—blue line), and rainfall in inches (bottom—green line).

All are over time for the duration of the project. Superimposed on these graphs are the durations of the intensive round, marked by dashed and solid lines.

Section 11—Results and Discussion: Do groundwater concentrations control soil gas concentrations at this site? And thus indoor air concentrations?

Table 11-1. External Soil Gas Locations and Their Flooded Status during Different Times

Location	Date and Status (WP=will not pump; WIL=water in the line; red lettering=1st Intensive Round)									
SGP1-3.5	02/15/11 WIL	Until	03/29/11 WIL	This port was never used again after it flooded. Water would never stay out of it.						
SGP1-6	02/03/11 WIL	04/26/11 WP	01/18/12 WP							
SGP1-9	03/03/11 WIL	03/04/11 WP	03/22/11 WIL							
SGP1-13	03/02/11 WIL	03/06/11 WIL	03/07/11 WP	03/17/11 WIL	03/22/11 WIL					
SGP1-16.5	02/21/11 WP	03/16/11 WIL								
SGP2-3.5	03/05/11 WIL									
SGP2-6	03/05/11 WP									
SGP2-9	03/03/11 WIL									
SGP2-13	03/02/11 WIL	03/06/11 WP	03/07/11 WP	01/18/12 WP						
SGP2-16.5	03/16/11 WP									
SGP3-6	03/02/11 WP	03/03/11 WP	03/04/11 WP	03/05/11 WP	03/06/11 WP	03/07/11 WP	03/08/11 WP	03/09/11 WP		
SGP3-9	12/15/11 WIL									
SGP3-13	03/02/11 WP	03/06/11 WP	03/07/11 WP	12/15/11 WIL	01/18/12 WP					
SGP3-16.5	02/10/11 WP	03/02/11 WP	03/16/11 WIL							
SGP4-3.5	02/22/11 WP	03/02/11 WP	until	05/25/11 WP	This port would never pump again					
SGP4-6	02/03/11 WP	03/02/11 WP	until	05/25/11 WP	This port would never pump again					
SGP4-9	02/22/11 WIL	03/02/11 WP	03/03/11 WIL							
SGP4-13	03/02/11 WP	03/06/11 WP	03/07/11 WP							
SGP4-16.5	03/02/11 WP	03/16/11 WP								
SGP5-3.5	03/02/11 WIL	03/03/11 WIL	03/04/11 WIL	03/06/11 WP	03/07/11 WIL	03/08/11 WIL	03/09/11 WIL	03/16/11 WIL	05/03/11 WP	
SGP5-6	02/18/11 WP	03/02/11 WP	until	05/25/11 WP						
SGP5-9	02/17/11 WIL	03/08/11 WIL								
SGP5-13	03/02/11 WP	03/06/11 WP	03/07/11 WP							
SGP5-16.5	03/02/11 WP	03/16/11 WP								
SGP6-3.5	01/25/11 WP	03/02/11 WP	until	05/25/11 WP	12/01/11 WP					
SGP6-6	05/18/11 WP									
SGP6-9	01/18/12 WP									

(continued)

Table 11-1. External Soil Gas Locations and Their Flooded Status during Different Times (continued)

Location	Date and Status (WP=will not pump; WIL=water in the line; red lettering=1st Intensive Round)								
SGP6-13	03/06/11 WP	03/07/11 WP							
SGP6-16.5	03/16/11 WP								
SGP7-3.5	03/05/11 WP	04/19/11 WP	04/20/11 WP	04/26/11 WP	05/03/11 WP	12/15/11 WP			
SGP7-6	02/03/11 WP	03/02/11 WP	until	05/25/11 WP					
SGP7-9	02/23/11 WIL								
SGP7-13	03/06/11 WP	03/07/11 WP							
SGP7-16.5	03/16/11 WP								

Note: where multiple successive dates are omitted, the word “until” is used.

The 13-ft depths are flooded by 03/01/11, but they were sampled instead of the 16.5-ft depths as of 03/17/11 for most of the rest of the project.

The 16.5-ft depths became possible to sample for soil gas again for most of the locations as of 08/22/11, except for SGP9-16.5.

However, by 10/22/11 only the 16.5-ft depth at SGP6 could still be used. It was no longer usable a few weeks after that.

Table 11-2. Internal Soil Gas Locations and Their Flooded Status during Different Times

Location	Date and Status (WP=won't pump; WIL=water in the line; red lettering=1st Intensive Round)								
SGP8-16.5	02/19/11 WIL	03/16/11 WIL							
SGP9-16.5	02/10/11 WIL	03/16/11 WP	08/22/11 WP	08/29/11 WP					
SGP10-16.5	02/19/11 WIL	03/16/11 WIL							
SGP11-16.5	03/15/11 WIL								
SGP12-16.5	02/22/11 WP	03/15/11 WIL							
WP-2	03/03/11 WIL								
SSP-2	03/09/11 WIL								

The 13-ft depths are flooded by 03/01/11, but they were sampled instead of the 16.5-ft depths as of 03/17/11 for most of the rest of the project.

The 16.5-ft depths became possible to sample for soil gas again for most locations as of 08/22/11, except for SGP9-16.5.

However, by 10/22/11 only the 16.5-ft depth at SGP6 could still be sampled. It was no longer usable a few weeks after that.

As stated before, the 16.5-ft depths were flooded and could not be used for soil gas sampling during the first intensive round. Additionally, SGP1-3.5, SGP4-3.5, and SGP4-6 became unusable as well either because of water in the line or they were unable to pump (see **Table 11-1**). SGP4 likely had difficulties due to its location in a breezeway between the 422/420 house and the building on the adjacent property. During freezing weather, slush and ice would pond and melt and refreeze in the path along this breezeway. In warmer weather, rainwater would gather in the walkway, flooding the path. It is possible that this constant influx of water kept some of the shallow SGP4 ports flooded.

Observations of water in lines or points that would not pump were less frequent at depths above the water table beneath the house, suggesting that the house created a considerable moisture shadow and that drainage away from the house was probably good.

11.2 Groundwater Concentration Trend

Groundwater samples were taken approximately once each month from all monitoring wells, generally with permeable diffusion bags. Sample locations included a nest of three wells at the south side of the house designated MW-1 A - C, a nest of three wells at the north side of the house called MW-2 A - C, and a single well called MW-3 inside the house. The lettering of these wells used during sampling is in some cases different than the lettering used at the time of construction.¹ The lettering of the intervals used during all groundwater sampling is shown in **Table 11-3**.

Table 11-3. Groundwater Monitoring Well Information.

Well Name	Screened Interval Depth (ft)	PDB Tether Length (ft)	Measured Total Depth of Well (ft on 08/29/12) ^a
MW1A	24–26	25	>25
MW1B	21–24	22'3"	23'9"
MW1C	16–21	18'3"	20'4"
MW2A	24–26	24	>25
MW2B	21–24	22'5"	24
MW2C	16–21	18'6"	21'2"
MW3	~19.5–24.5	23'2"	24'8"

^a This closely agrees with another set of total depth measurements taken 1/6/11.

The PCE data from these monitoring wells are plotted on **Figure 11-2**. Chloroform was not detectable in any of these samples. Note, however, that chloroform had been detected by the EPA laboratory in samples collected for preliminary site screening (**Table 3-6**). Chloroform had also been detected in groundwater in previous work at the Mapleton-Fall Creek site across the intersection of East 28th St and Central Avenue from our duplex.

¹ Note that the MW1 nest was constructed over two widely sampled mobilizations with the middle interval constructed last. This is important to consider when interpreting the appended boring logs.

Section 11—Results and Discussion: Do groundwater concentrations control soil gas concentrations at this site? And thus indoor air concentrations?

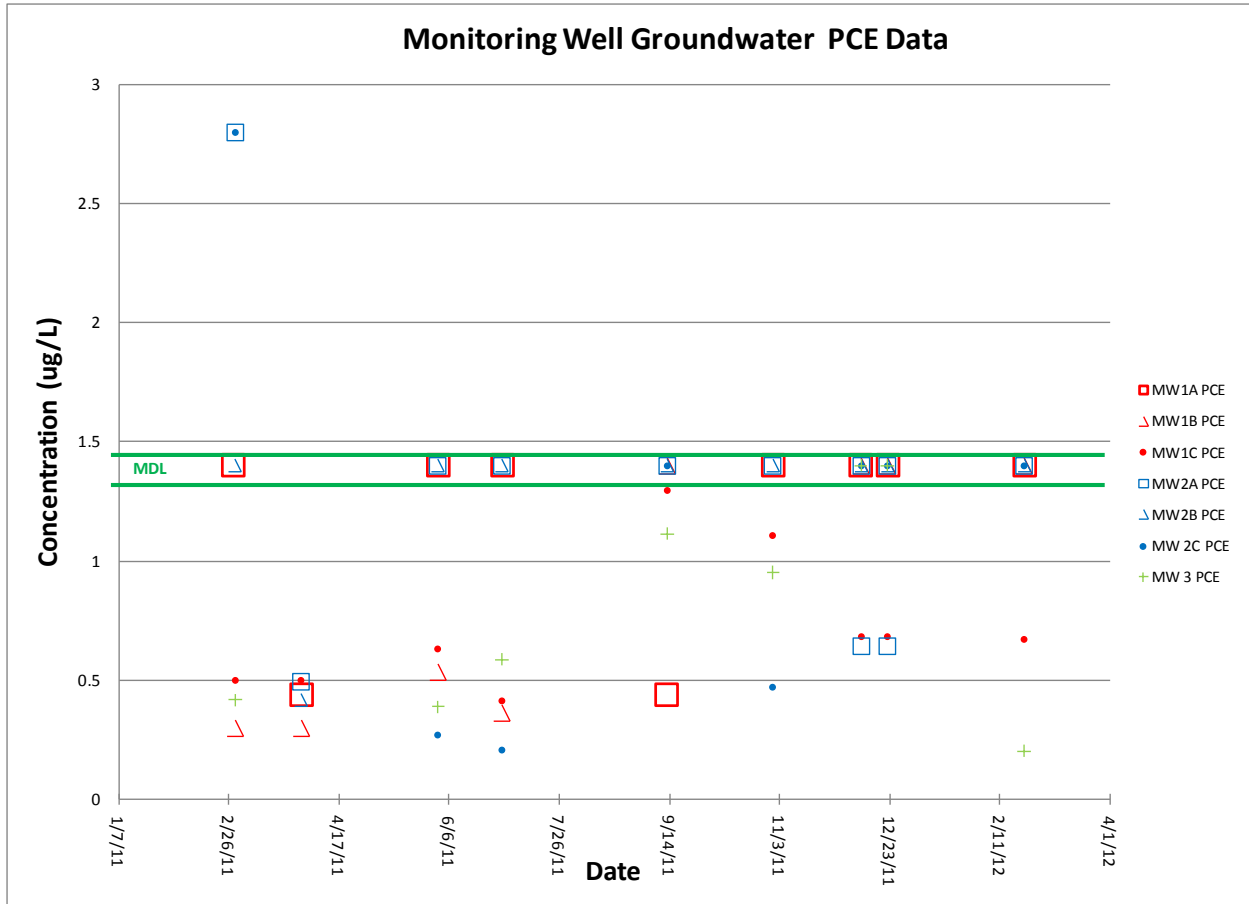

Figure 11-2. Monitoring well water data for PCE versus time.

Note: the samples within the green bars are below the method detection limit (MDL) and are reported only at the MDL.

In addition groundwater samples were collected from soil gas points when they were temporarily flooded using a peristaltic pump. These results are shown in **Figure 11-3**. Again chloroform was not detected in any of these samples.

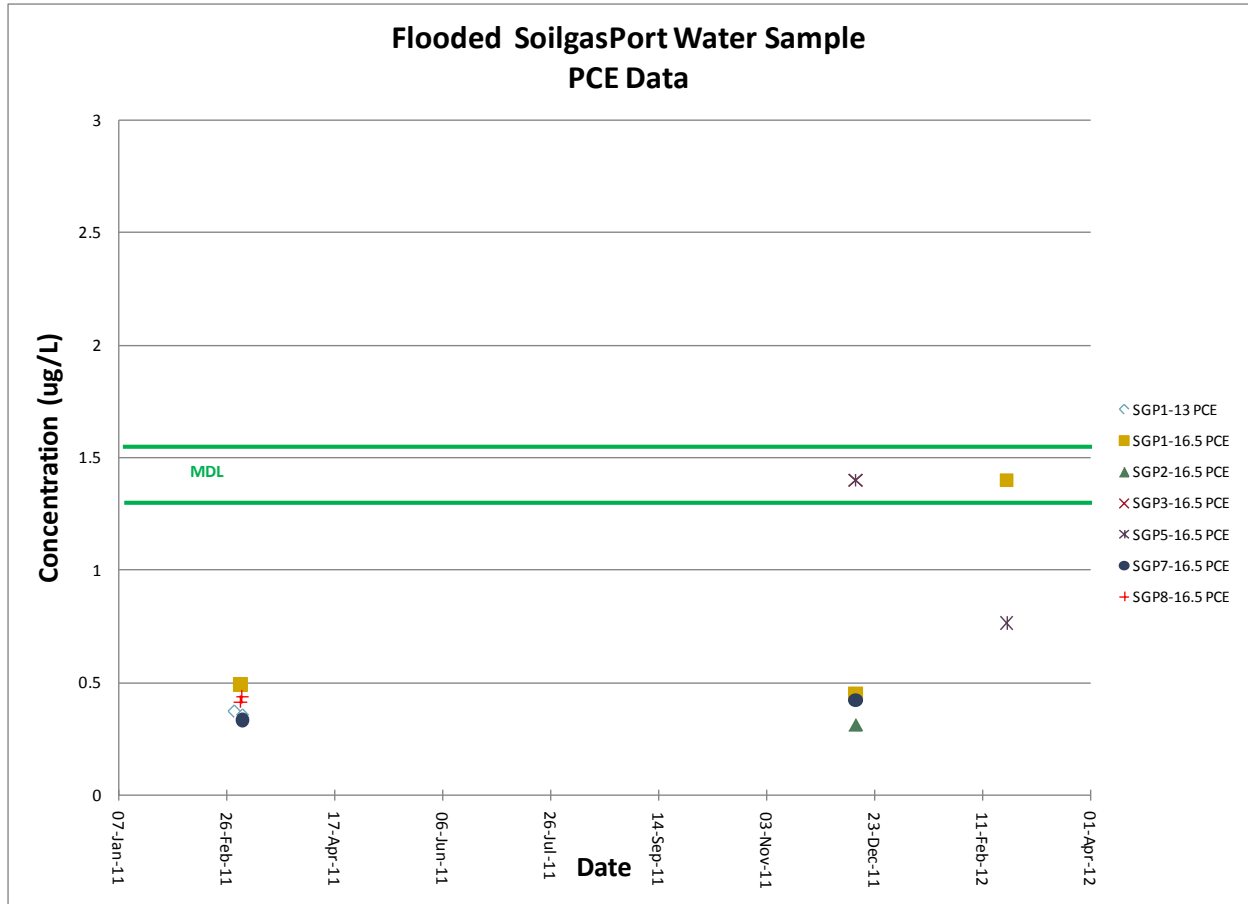

Figure 11-3. Flooded SGP water data for PCE versus time.

Note: the samples within the green bars are below the method detection limit (MDL) and are reported only at the MDL.

All samples were analyzed at the EPA NERL laboratory. Most data for PCE concentrations were below the MDL determined from seven replicate injections of a low concentration standard, but the concentrations reported are believed to represent actual detections based on professional judgment after a detailed review of the raw data. On **Figures 11-2** and **11-3**, the data points within the bars, marked as MDL, are nondetects plotted at the MDL. The samples with the highest concentrations of PCE in groundwater, and the only samples with concentrations above the standard definition of the MDL, were collected in February 2011.

Figure 11-2 shows that results were generally consistent from well to well for a given sampling event during the March through July 2011 period. In other words, there is relatively little spatial variability between the wells. During that March through July period, the samples with all nondetects came from the deepest intervals—MW-1A and MW-2A. During that period at least four of the seven intervals sampled in each round showed a PCE peak that was detectable according to professional judgment. Concentrations occupied similar ranges in **Figures 11-2** and **11-3**, even though the results in **Figure 11-3** came from flooded soil gas ports above the depth of the wells sampled with peristaltic pumps, rather than the permanent monitoring wells that were sampled with permeable diffusion bags.

After July 2011, PCE detections become less frequent: in each round only two or three of the seven intervals sampled yielded peaks that were discernible according to professional judgment. During the post-July period, the only interval that was always detectable was the shallowest interval on the south side

of the duplex—MW-1C. MW-2C, north of 422 East 28th St, which in February 2011 had one of the highest concentrations, had all nondetects in several fall rounds, with the exception of one detection in November.

Our confidence in this groundwater data requiring professional judgment at the lower end of the instrumental range is greatly strengthened because a Henry's law conversion shows good agreement between these PCE concentrations and the PCE concentrations observed in gas phase samples from nearby deep soil gas ports. This suggests that the low groundwater concentrations are at quasi-equilibrium with deep soil gas concentrations.

11.2.2 Is the Groundwater Concentration Trend Correlated to Potentiometric Surface?

Because chloroform was always below the groundwater detection limit at the EPA laboratory, conclusions cannot be drawn directly, although in other sections, we have argued that the chloroform trend in deep soil gas is temporally correlated to the potentiometric surface.

Figure 11-1 shows some broad similarities to **Figure 11-2**. The fraction of monitored intervals in which PCE is detectable according to professional judgment is highest in the winter and spring months of 2011 when the highest rainfall and streamflow were noted. However, there is not enough complexity and resolution in these trends to judge whether this is real or merely coincidental.

11.2.3 Is the Groundwater Concentration Trend Correlated to Indoor Air Concentrations?

Because all samples are nondetects, no conclusions can be drawn for chloroform in groundwater. For PCE, there is a rough correspondence between **Figure 11-2** showing groundwater concentrations and the trend of PCE in indoor air discussed in Section 5. PCE concentrations in indoor air are highest in the winter of 2011. They reach a low in July 2011 and only modestly recover in the winter of 2012. Similarly PCE was detectable according to professional judgment in all but the deepest intervals of groundwater through late June 2011. According to professional judgment, the number of intervals in which PCE is detected markedly declines in the groundwater samples taken after July 2011.

11.3 Soil Moisture Trends

11.3.1 Correlation with Rainfall Measurements

Figure 11-4 presents data from implanted soil moisture probes (i.e., irrometers). There is a rough correlation between **Figures 11-4** and **11-1**: the soil is drier in the hotter months and wetter in the cooler months. In **Figure 11-4**, all sensors read more saturated soil conditions until late May 2011, when they began to dry out. This soil moisture trend corresponds reasonably well with the gradual tapering off of the period of high rainfall in mid-April (see **Figure 11-1**) and with the observations that many soil gas sampling points would not pump or showed visible water in March 2011 (Tables 11-1 and 11-2 in Section 11.1). The weather began to get wetter again in October, which corresponds with the increase in Fall Creek discharge rates (**Figure 11-1**). These year-long trends in rainfall and water level also correspond with the period when the 16.5-ft depths became usable again and when they finally stopped pumping.

In **Figure 11-4**, the sensor at the 6-ft depth beneath the house shows that it was under more saturated conditions at the beginning of the project, but dried out toward May and through the summer. However, this sensor continued a slow, steady progression toward drier levels. Note that the sensors themselves were conditioned by soaking before installation; although that procedure would only have a short term effect in most soils, it is possible that it led to a longer bias in tighter soils (which are generally found at shallower depths at this site, see Section 3.1.1). The 13-ft and 16.5-ft depths beneath the building stay

more saturated throughout the project. This is reasonable for beneath the house despite any possible moisture shadow given the depth to groundwater (assuming also the existence of a capillary fringe).

The outside moisture sensors for the 3.5-ft and 6-ft depths agree with the seasonal rainfall changes (see **Figures 11-1** and **11-4**). The moisture readings at the 13-ft outside depth do not correlate with the other datasets. This probe began the project with readings toward the more saturated end of the scale and then dried out in May and into the summer. However, it stayed very dry in fall 2011 and winter 2012, even when other datasets suggest that soil moisture conditions should have gotten wetter. The outdoor sensors for the 9-ft and 16.5-ft intervals (not shown) yielded readings that, according to the manufacturer, could mean the sensors are recording extremely dry conditions, they have a broken connection, or the soil dried out and shrunk away from the sensor and never reconnected. For the 13-ft depth outdoor sensor, based on the pattern it followed before May 2011, it seems likely that the soil dried away from the sensor and never regained connection. For the 9-ft and 16.5-ft sensors, it seems more likely that the sensors have a broken connection. Given that these sensors are designed to be permanently implanted, they cannot easily be removed for servicing.

11.3.3 Relationship to Observed Stratigraphy

Figures 11-5 and **11-6** show a generalized cross section of the soil types present in the immediate area of the 422/420 house. The layer beneath the topsoil consists mostly of silt and clay. This layer would be expected to retain the high amounts of rainfall during the wetter periods, which corresponds to the shallower depths registering moisture on **Figure 11-4** for the beginning of the project, and it could also correspond to the difficulty pumping shallower soil gas ports during this time. The flooding of the deeper soil gas ports within the sand and sand and gravel layers and the moisture readings for the deeper moisture sensors could be in response to the changing water levels at Fall Creek to the south of the 422/420 house, because there appears to be a rough correlation between the rise and fall of Fall Creek and the moistening of some of the sensors (see **Figures 11-1** and **11-4**).

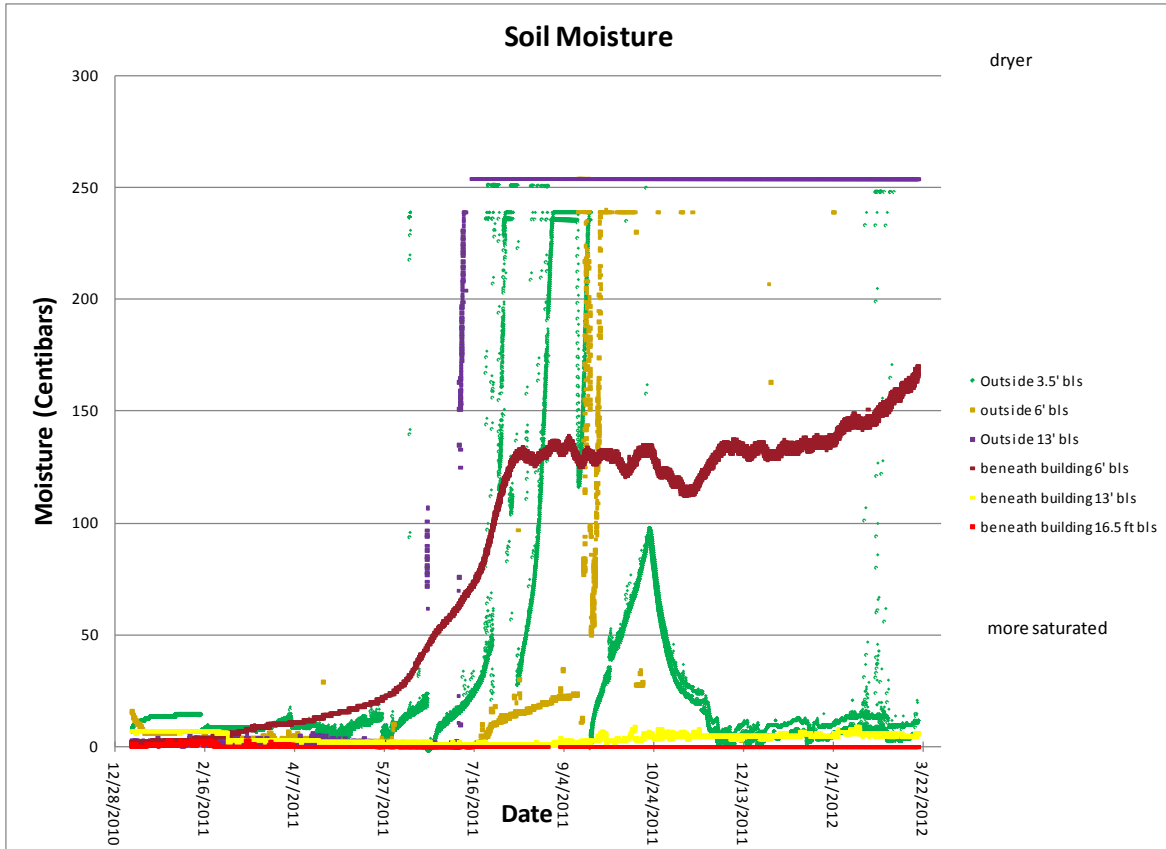

Figure 11-4. Soil moisture: irrometer moisture data in centibars for the interior and exterior of the 422/420 house.

Note that lower readings are more saturated.

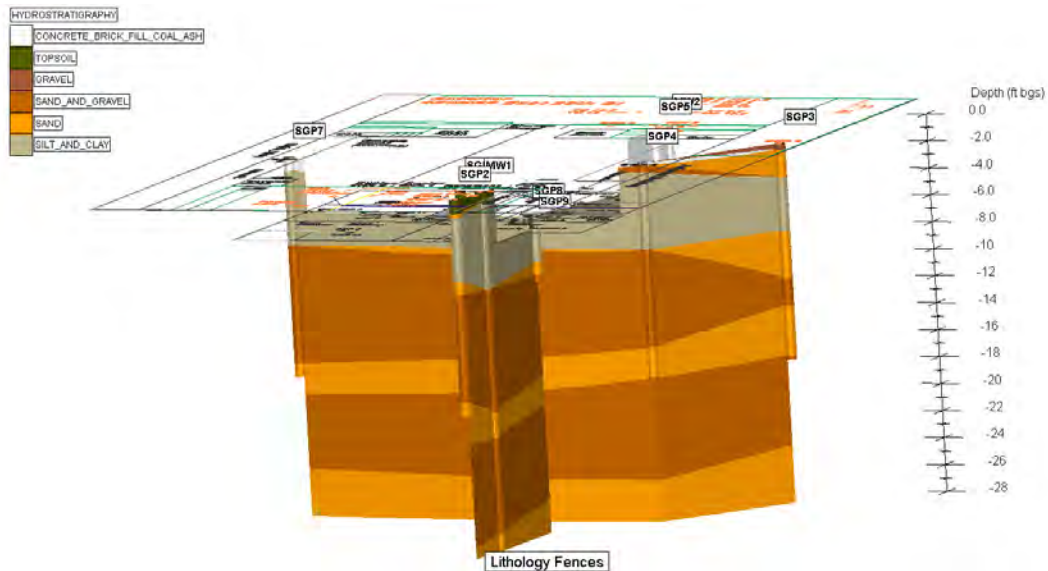

Figure 11-5. Lithological fence diagram showing some of the major soil types beneath the 422/420 house.

The view is toward the north from the street in front of the house. The empty white area at the top of the soil figure represents the house basement. This figure shows that in the immediate vicinity of the house, silt and clay are present until 7.5–8 ft. After that, sand and gravel alternate with layers of sand.

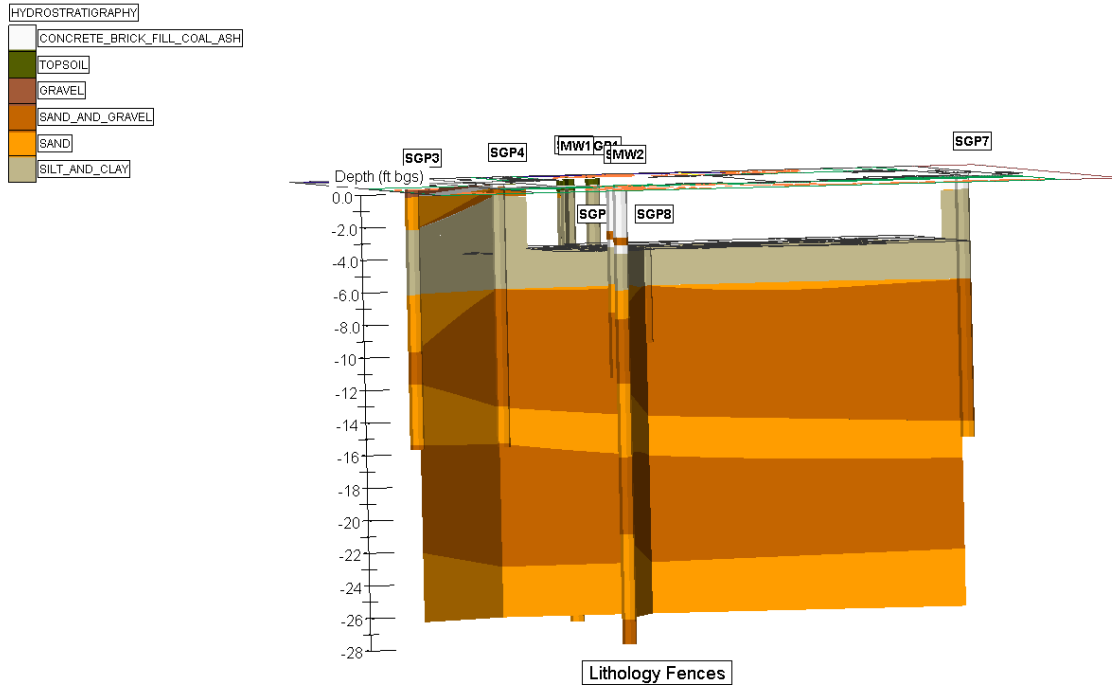

Figure 11-6. Lithological fence diagram showing some of the major soil types beneath the 422/420 house.

The view is toward the south from the backyard of the house. The empty white area at the top of the soil figure represents the house basement. This figure shows that in the immediate vicinity of the house, silt and clay are present until 7.5–8 ft. After that, sand and gravel alternate with layers of sand.

11.4 Correlation of Groundwater Concentration Changes to Deep Soil Gas

MW1 and 2 are both a series of three clustered wells, labeled A, B, and C. Each well in the cluster extends to the following screen depths: 24 ft to 26 ft, 21 ft to 24 ft, and 16 ft to 21 ft, respectively (see **Table 11-3**). Because sampling occurred within these intervals, comparing the PCE behavior of the deepest nearby soil gas ports (the 13-ft and 16.5-ft depths) might provide insight into the linkage between PCE in the groundwater and the soil gas.

The nearest soil gas ports to the water monitoring wells are

- SGP1 and SGP2 by the MW-1 cluster,
- SGP5 and SGP6 by the MW-2 cluster, and
- SGP8 and SGP9 near MW-3.

Data from each of those SGPs are represented in **Figures 11-7** through **11-11**.

When soil gas data were available for the deepest soil gas ports (at 13 and 16.5 ft), these SGPs show a similar year-long pattern to what the groundwater data show (**Figures 11-2** and **11-3**): the elevated PCE concentrations in the cooler weather at the beginning of the project gradually decreased toward the warmer summer months and then rose again as the weather began to cool off. The 16.5-ft depths also show elevated PCE concentrations at a comparable time to the elevated PCE concentrations in the groundwater data. Deep soil gas intervals plotted in **Figures 11-7** through **11-9** also show a similar pattern over a short time period for the September/November period: a short rise in September and then falling off in PCE concentrations after lower summer concentrations (compare with **Figure 11-2**).

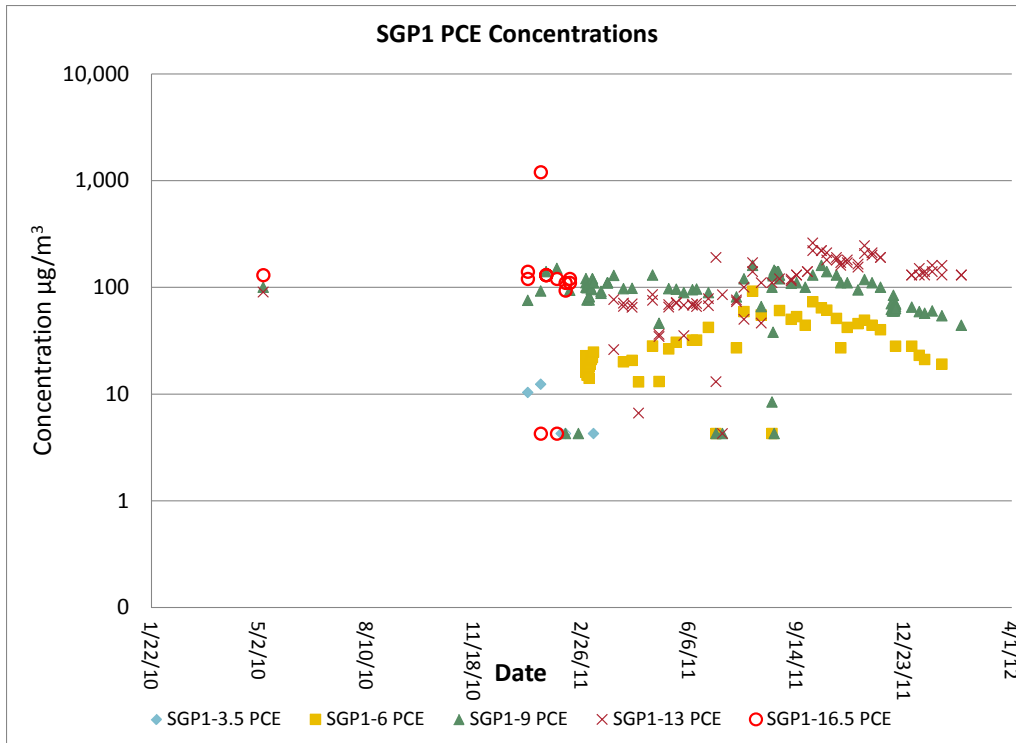

Figure 11-7. PCE concentrations at each of the SGP1 ports over time.

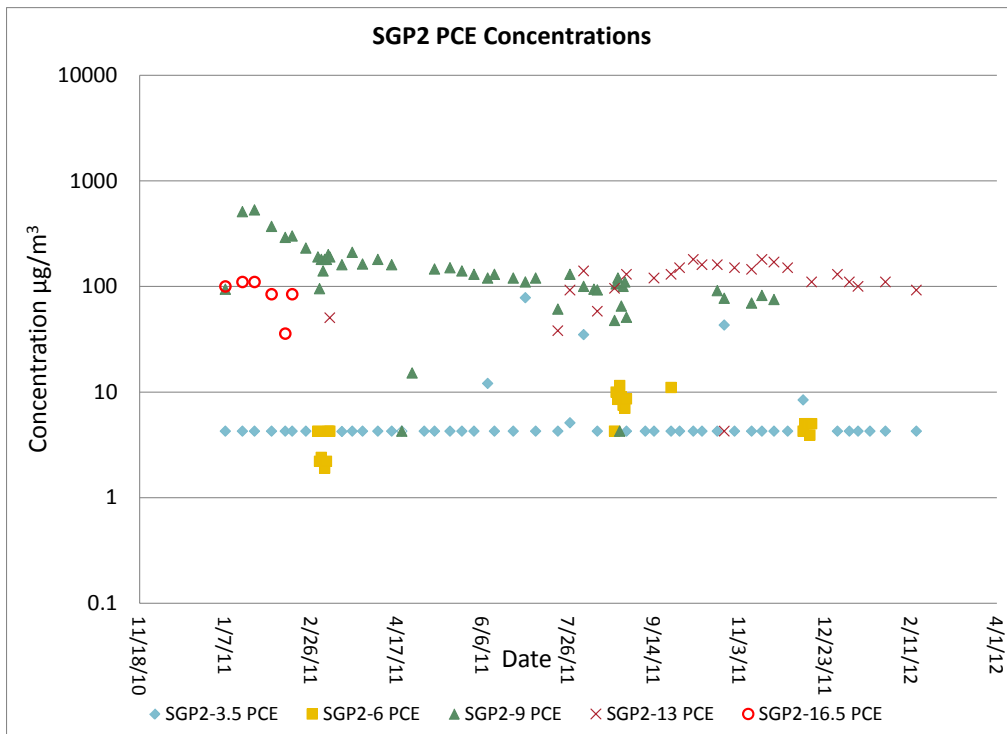

Figure 11-8. PCE concentrations at each of the SGP2 ports vs. time.

Section 11—Results and Discussion: Do groundwater concentrations control soil gas concentrations at this site? And thus indoor air concentrations?

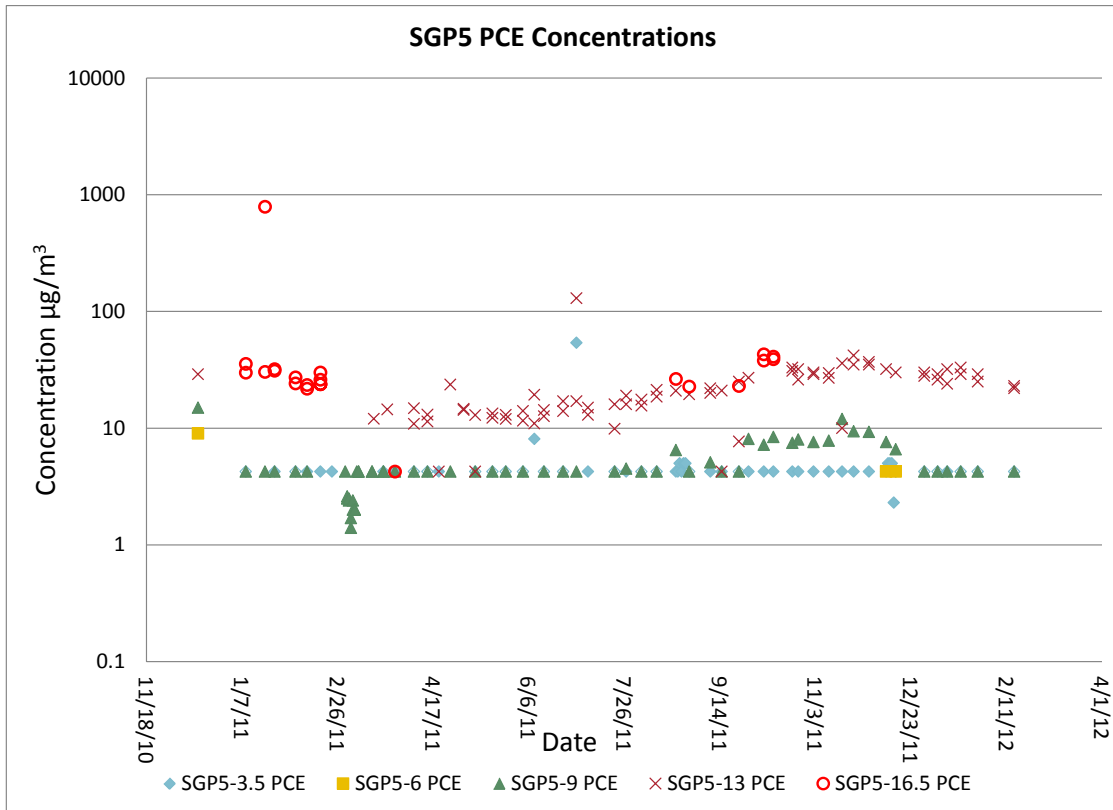

Figure 11-9. PCE concentrations at each of the SGP5 ports over time.

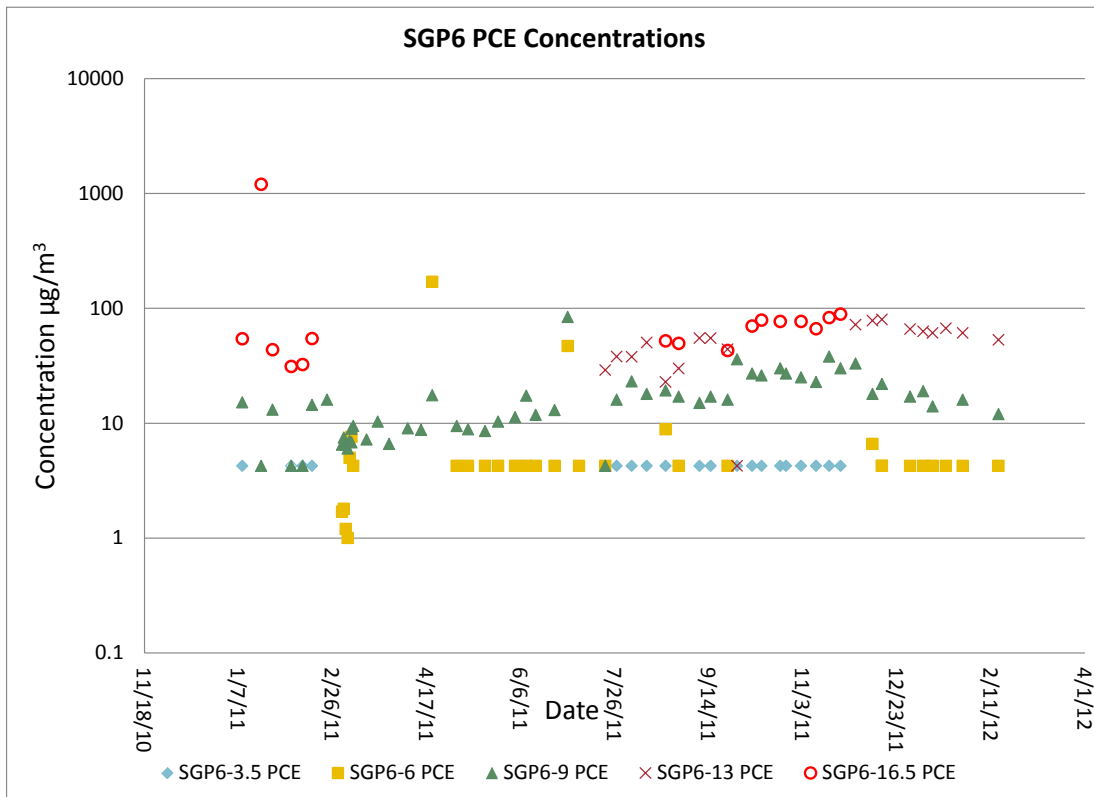

Figure 11-10. PCE concentrations at each of the SGP6 ports over time.

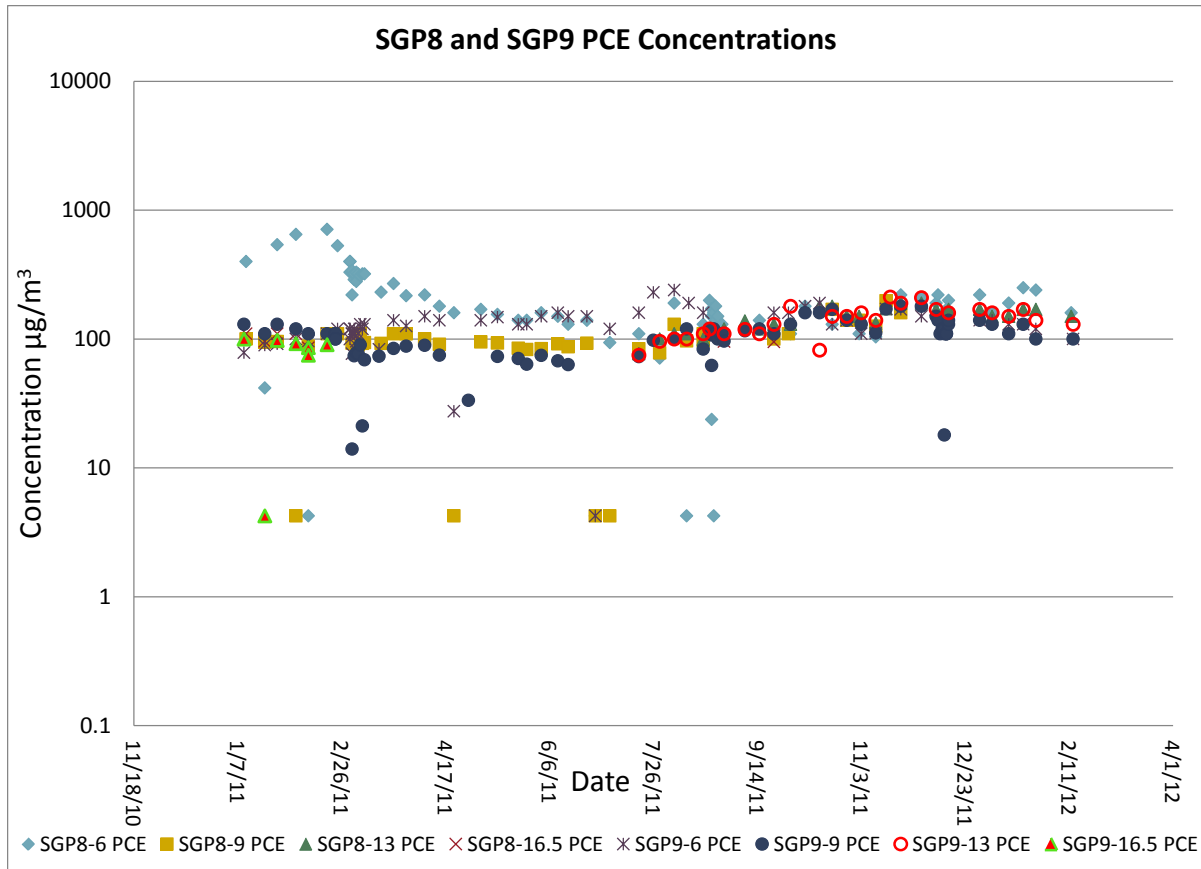

Figure 11-11. PCE concentrations at SGP8 and SGP9 ports over time.

11.5 Revisions to Conceptual Site Model

In Sections 2 and 2.1, we review the generally accepted, general model of vapor intrusion processes. In Section 3.1.6, we present an initial conceptual site model for this specific duplex on this specific site. A conceptual site model is always subject to revisions and refinement based on new data. In this section, we present revisions to the site-specific conceptual site model.

First, it should be noted that this study situation is unusual in that we have gathered an extremely detailed dataset about one particular duplex known to be in proximity to a group of known, but poorly defined, potential sources:

- 10 historic drycleaners within ¼ mile, believed to be upgradient
- an immediately adjacent building with a complex history of multiple commercial/industrial uses
- aged combined sewers in a community with known chlorinated VOC disinfection by-products in drinking water.

However, none of these potential sources has been thoroughly investigated or delineated—a situation that is likely common in urban areas (Dickson et al., 2010). In contrast, vapor intrusion practitioners more typically work on sites where there is a known anthropogenic source term and some delineation of a groundwater plume on a scale of hundreds of feet/blocks. But practitioners are frequently dealing with individual residences about which very little is known, typically only the results of a brief survey/homeowner interview and a very small number of measurements in indoor or subslab air.

The following revisions to our conceptual site model of this duplex and the vapor intrusion sources supplying it can be made:

- The groundwater level beneath the house is subject to rapid swings of up to 5 ft over the course of a few days during seasonal flooding in the adjacent Fall Creek and potentially to the influence of combined sewers.
- The stack effect caused by indoor/outdoor temperature differentials operates not only during the heating season, but also during the summer, because of the “solar stack effect” and the storage of heat in the building during cool late summer/fall nights. Differential pressure measurements indicate that changes in building differential pressure are reflected in a measureable advective driving force between the 13-ft depth near the water table and the 6-ft depth directly beneath the basement. Therefore, in this case, advection may be the primary cause of VOC migration through the deeper portions of the vadose zone.
- The heterogeneity of the subslab concentrations beneath the duplex suggests the absence of an engineered gravel layer. Therefore, the subslab region of the house does not behave here as a well-mixed plenum.
- PCE is apparently widely spatially distributed in site groundwater at concentrations well below the current 5 µg/L MCL (U.S. EPA, 2012a). These shallow groundwater concentrations apparently control deep soil gas concentrations. Only a moderate degree of attenuation occurs in those deep soil concentrations as they are drawn toward the basement of the structure. Substantial attenuation occurs in the upper 6 ft of the site external soil gas, which is finer grained materials than the sandy deeper materials. It is currently unclear whether this is due to gas permeability contrasts, sorption processes, or most likely barometric pumping dilution. Substantial attenuation also occurs across the building envelope between subslab and indoor air.
- Chloroform is present in highest concentration in deep soil gas. Substantial chloroform has historically been detected in groundwater on a site 200 ft to the southwest. Chloroform was also detected in groundwater at this house in preliminary sampling. Further studies are planned to determine if the lack of detections in recent groundwater samples on site indicate migration through deep soil gas from offsite sources or losses in the sampling and analysis process. Chloroform attenuation is substantial between the area just above the water table and the 6 ft depth below the structure. Chloroform is further attenuated between subslab air and indoor air.
- The relative importance of the potential sources of PCE and chloroform—historic drycleaners, the adjacent commercial/industrial quadraplex, and storm sewers/drinking water disinfection—is unclear.
- Sewer lines and laterals likely play some role in contaminant fate and transport in this system. Elevated concentrations of PCE and chloroform are present in the headspace of sewer gas. Their role as a direct entry pathway can be minimized through plumbing trap and vent maintenance. Their role in lateral transport through the vadose zone and into the subslab of the duplex will be elucidated through future geophysical studies.
- There is a seasonal component to the PCE and chloroform indoor concentrations (**Figure 11-12**). The seasonal component is partially but not completely correlated to the strength of the stack effect.
- Concentrations of benzene, hexane, and toluene in indoor air are quite similar to ambient levels and appear to change in lockstep with ambient air, although there are some traces of benzene in soil gas (**Figure 11-12**). TCE in indoor air also tracks ambient concentrations when TCE is low, but follows a trend that very similar to PCE when TCE concentrations were high at the beginning of the study, suggesting a contribution of subsurface sources to TCE indoor air concentrations.

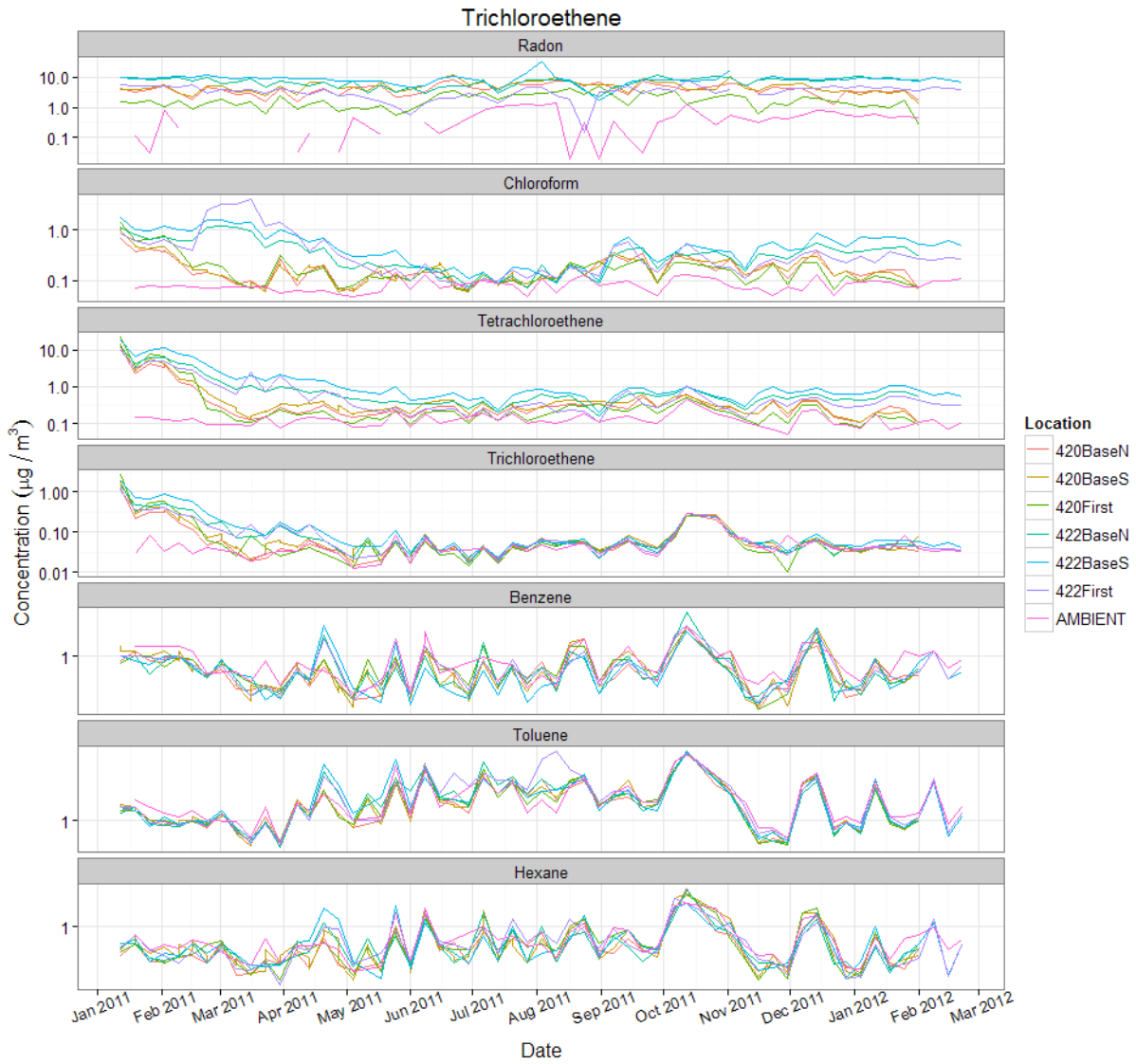

Figure 11-12. Temporal plot of log indoor air concentration for VOCs ($\mu\text{g}/\text{m}^3$) and radon (pCi/L) by sample location over the study period.

Table of Contents

12. Results and Discussion: Special Studies	12-1
12.1 Summary of Temporary vs. Permanent Subslab Sampling Study.....	12-1
12.2 Summary of Fan Testing	12-1
12.2.1 Fan Test Objectives	12-3
12.2.2 Fan Test Experimental Methods.....	12-3
12.2.3 Fan Test Results and Discussion	12-4
12.2.4 Fan Test Lessons Learned	12-11
12.3 Testing Utility of Consumer Grade Radon Device (Safety Siren Pro).....	12-11
12.3.1 Consumer-Grade Radon Device Test Objectives.....	12-12
12.3.2 Consumer-Grade Radon Device Test Methods.....	12-12
12.3.3 Consumer Grade Radon Detector Test Results and Discussion.....	12-12

List of Figures

12-1. Fan test matrix.	12-4
12-2. Fan position in stairwell (note plastic sheet over doorway).....	12-4
12-3. Differential pressure before, during, and after fan tests (fan tests denoted by vertical bars).	12-5
12-4. Radon on second floor before, during and after fan tests (fan tests denoted by vertical bars).	12-6
12-5. VOC Field instrument data before, during and after fan tests (fan tests denoted by vertical bars).	12-7
12-6. Note height of basement window and vent (sealed for this study).	12-8
12-7. Subslab and soil gas VOC data during fan test period.....	12-9
12-8. VOC data before, during, and after fan testing, Method TO-15.	12-10
12-9. Comparison of fan test responses of radon, PCE, and chloroform in 422 basement.	12-11
12-10. Comparison of electret and Safety Siren results.	12-13

List of Tables

12-1. Quality Objectives and Criteria for Special Studies	12-2
12-2. Comparison of Safety Siren, Alphaguard, and Electret Data.....	12-13

12. Results and Discussion: Special Studies

We conducted three special studies in the same facility that go beyond the objectives articulated in Section 2 around which the overall study was designed. These studies addressed specific research needs identified after the main study was initiated. In this section, we present methods, results, and discussion for a series of these studies, which can be perhaps best understood as discrete “mini-projects.” These studies examined the

- VOC measurement efficiency of temporary subslab ports as compared with permanent subslab port constructions (Section 12.1),
- use of box fans to induce flow into the structure in an attempt to create “worst case” conditions for vapor intrusion (Section 12.2), and
- use of a consumer grade radon detector as an indicator of vapor intrusion (Section 12.3).

Table 12-1 provides data quality objectives and criteria for these studies and parallels **Table 2-3**.

12.1 Summary of Temporary vs. Permanent Subslab Sampling Study

Please refer to the report in Appendix B for a full discussion of methods and results of the study conducted before the main study that compared nearly collocated temporary and permanent subslab ports. The temporary ports were sealed during the main study.

Under the conditions studied here, the VOC and radon concentrations measured simultaneously in soil gas using nearly collocated temporary and permanent ports appeared to be independent of the type of port. The variability between nearly collocated temporary and permanent ports was much less than the spatial variability between different locations within the same residential duplex.

12.2 Summary of Fan Testing

Vapor intrusion guidance in many jurisdictions has suggested that worst-case conditions occur under specific meteorological conditions that provide maximum driving forces (i.e., a maximum differential pressure driving flow into the building). Although many guidance documents (e.g., Department of Defense guidance, state guidance from New Jersey and Massachusetts) suggest that these conditions occur in winter, not all datasets show the same seasonality. Also, it is logistically difficult to schedule extractive sampling events to occur during specific meteorological conditions. Some documents (e.g., handbooks by the Electric Power Research Institute and the U.S. Navy) have suggested the possibility of using fans to quickly depressurize a building and enhance vapor intrusion by creating a pressure gradient from the subsurface into a building, as was done in a single test using a window fan at a Hill Air Force Base residence in March 2006 (GSI Environmental, 2008). In this case, TCE increased by two times in indoor air, and although radon did not, an increase in both the TCE and radon attenuation factors was observed. A similar method could provide a quick, inexpensive, and easy-to-implement method to determine the potential for vapor intrusion into a building.

Conversely, it has also been suggested that fan-induced over-pressurization of a building could help distinguish indoor volatile compound sources from vapor intrusion. Tests were conducted in 2008 in which positive and negative pressurization fans were each applied to three matched townhouse units at Moffett Field in California (Mosley et al., 2008; Lutes et al., 2009). Results were not always in the predicted direction. In another study, a detailed mathematical approach to quantify the relative proportions of a contaminant attributable to subslab and indoor sources, based on measurements of radon and VOCs under two baseline and fan perturbed conditions, was developed and tested in a former industrial building in Indianapolis (Mosley et al., 2010).

Table 12-1. Quality Objectives and Criteria for Special Studies

Study Question: Qualitatively Stated (from SOW objectives when applicable)	Study Questions: Quantitatively/Statistically Stated	Measurement Used To Support Study Question	Measurement Performance or Acceptance Criteria (for this question)
Temporary vs. Permanent Subslab Sampling Study			
Identify functional differences between permanent and temporary subslab probes.	<ul style="list-style-type: none"> ▪ Is there a statistically significant difference between analyte concentrations in gas samples collected from permanent and temporary subslab probes? ▪ Is there evidence of a significant amount of leakage of indoor air into either type of probe during sample collection? 	<ul style="list-style-type: none"> ▪ Radon and VOC measurements in subslab soil gas samples ▪ Tracer gas (helium) measurements in subslab soil gas samples 	<ul style="list-style-type: none"> ▪ Agreement of subslab concentrations within +/-30% was defined as adequate given the variable nature of subslab soil gas distribution. Helium concentrations indicative of significant leakage are addressed in the QAPP. For each comparison 5 pairs of measurements are available.
Fan Testing			
Evaluate the effectiveness of fan negatively pressurizing the structure as a quick, inexpensive method to determine the potential for vapor intrusion into a building.	<ul style="list-style-type: none"> ▪ Do concentrations of VOCs and radon and indoor air rise significantly in response to installation of a fan negatively pressurizing the structure? 	<ul style="list-style-type: none"> ▪ Radon and VOC concentrations, both instrumental and extractive measurements during a time period of at least 6 weeks before, during, and after the fan tests. ▪ Differential pressure during the same time period. 	<ul style="list-style-type: none"> ▪ This dataset can be analyzed as an interrupted time series with the intervention (the fan operation) applied and removed at various known times. Clearly, however, the intervention was not the only control on the indoor concentration, because other independent variables, such as weather phenomena, were measured but not controlled. The intervention was expected to be abrupt and permanent (a step function). Can use time series analysis to evaluate the size of the effect attributable to the fan and whether it is statistically significant. http://www.oregoneval.org/ANALYSIS%20OF%20INTERRUPTED%20TIME%20SERIES%20FINAL.pdf http://wps.ablongman.com/wps/media/objects/2829/2897573/ch18.pdf ▪ The number of data points depends on the duration of the intervention. We expect, however, to perform at least some fan tests with a 48-hour or greater duration, which will yield approximately 20 field GC VOC samples at each of four indoor locations and 45 or more Alphaguard radon measurements at each of two indoor locations during the application of the intervention. Differential pressure data are being acquired every 15 minutes, which should provide approximately 190 measurements on each of five channels during the intervention (fan operation). Longer periods of data with the intervention withdrawn are also expected before and after the period of fan testing, although not necessarily between individual fan tests.
Can the use of a simple fan system create worst case vapor intrusion conditions at a time when they otherwise would not be occurring?	<ul style="list-style-type: none"> ▪ Does the magnitude of the fan effect exceed the difference between the 25th and 75th percentiles of the distribution of concentrations measured over the year? 	<ul style="list-style-type: none"> ▪ Radon and VOC concentrations, both instrumental and extractive measurements. 	<ul style="list-style-type: none"> ▪ We achieved at least 50 week-long extractive measurements obtained during time periods when the fan was not used that can be used to define an annual distribution for both VOC and radon to which the magnitude of the fan effect can be compared. ▪ A second distribution can be defined using what is expected to be at least 400 measurements each for the online Alphaguard radon and online GC. This dataset, although larger, is expected to be less representative of the full year's seasonal variance. However, it is expected to allow evaluation of the diurnal variance in at least two different seasons.
Consumer Grade Radon Device Testing			
Evaluate the ability of a widely available low cost consumer grade radon detector based on an ionization chamber to provide a continuous indication of soil gas entry into the structure. (Safety Siren Pro Series 3 manufactured by Family Safety Products Inc.).	<ul style="list-style-type: none"> ▪ Does the measurement of radon concentration using this consumer-based analyzer agree within +/- 30% to the readings from the electret and Alphaguard methods >90% of the time? 	<ul style="list-style-type: none"> ▪ The Safety Siren has two displays—"short term" (average over previous 7 days) and "long term" (average from time of last reset, up to 5 years). Readings available after a minimum of 48 hours of operation. Recorded short-term reading at each of six indoor stations weekly. ▪ Comparison with ongoing electret and Alphaguard measurements. 	<ul style="list-style-type: none"> ▪ Six stations were sampled: 422 basement S, 422 basement N (downstairs Alphaguard), 420 basement S, 422 first floor, 422 second floor office (upstairs Alphaguard), and 420 first floor. Impractical to use the safety siren for ambient measurement because of temperature and power issues. Added electrets measurement during the safety siren test period at 422 second floor office for an additional comparison. ▪ At seven stations the Safety Siren can be compared to the electrets being routinely operated with a one-week duration. Collected 8 weeks of comparative data. ▪ At two stations the Safety siren can be compared with the Alphaguards taking hourly data, averaged over the week, providing at least 8 more pairs of data points. ▪ Data analysis approaches to be used for comparing methods are presented in Sections 3.4.4 and 8.3.3 of the main QAPP.
	<ul style="list-style-type: none"> ▪ Does the consumer-grade radon detector provide a useful indication of the weekly average infiltration of VOC containing soil gas? 	<ul style="list-style-type: none"> ▪ Month-long correlation test between consumer-grade radon detector and other radon detectors. ▪ Year-long dataset on radon/VOC correlation in this house. 	<ul style="list-style-type: none"> ▪ We will judge the answer to this study question to be "yes" if the Safety Siren is shown to adequately correlate with the Electrets (see above) AND radon is shown to be correlated to VOCs in the main study dataset (see objective A-2 in the main QAPP Table 3-2).

12.2.1 Fan Test Objectives

Previous studies of the fan testing method by others were generally designed to provide a line of evidence to confirm that indoor air contaminants were from vapor intrusion, as opposed to an indoor source. The fan testing described in this section (performed at the 420/422 East 28th St. site in Indianapolis) has a somewhat different objective. Using the long-term, detailed temporal variability dataset available for this site, we evaluated whether a simple fan-induced depressurization could mimic the worst case vapor intrusion conditions observed at the site. Such a “fan-induced worst case,” if available on demand, could allow the number of sampling rounds, and, thus, the disturbance of residents to be minimized. It could also expedite the vapor intrusion evaluation process and, if necessary, mitigation, which many stakeholders would find desirable. We formally stated the objective as follows:

Evaluate the effectiveness of fan negatively pressurizing the structure as a quick, inexpensive method to determine the potential for vapor intrusion into a building. Specifically, we seek to determine if the use of a simple fan system can create worst case vapor intrusion conditions at a time when they otherwise would not be occurring.

12.2.2 Fan Test Experimental Methods

The fan testing study design entailed concurrently evaluating the transient response of indoor air concentrations, subslab soil gas concentrations, subslab pressure gradients, and air-exchange rates arising from a change in fan setting (i.e., air-flow rate). The test was conducted primarily on the 422 side of the duplex (fans will be operated on that side only). Multispeed fans were used as in previous screening tests, but testing rapidly settled on the highest fan speeds. In principle, the target flow rate of the fan can be established by monitoring the subslab pressure gradient. We evaluated the initial results rapidly; chose a fan operating speed and position that yield a maximum (plateau, absolute) value of under-pressurization; and used these results to begin monitoring subslab soil gas, air-exchange rate, and indoor air quality with laboratory methods. Laboratory VOC methods included 24-hour passive SKC Ultra samplers and 24-hour Summa canisters. An additional indoor sampling location on the second floor of the 422 side was established and used just for this test.

Our plan was that the fan would be operated at a high enough speed to ensure that the pressure differential across the slab is always negative, but, if possible, not so high of a speed that it induces outside air to flow down around the outside of the foundation into the subslab area. We monitored the subslab vapor concentration to ensure that outside air flow did not predominate. If concentrations had decreased over time to near zero values, we would have interpreted this as outside air flowing in around the foundation, but this did not occur. If concentrations in the subslab remained steady, we then assumed that the system was at quasi-equilibrium. If concentrations in the subslab area increased with time, we would have assumed that, prior to the test, they had been diluted from outflow from the house and were now being increased by capture of additional soil gas. After a sufficient period of fan operation (intended to maximize the flux of subsurface vapors into the building), indoor air quality was tested with off-site methods to determine VOC concentrations.

We initially tested the use of box fans in second floor windows (Test A shown in **Figure 12-1**); however, we found that this did not create a strong depressurization effect. We next tested a fan position at the head of the stairs leading from the basement to the first floor (Tests B through I). Two commercial box fans were collocated with a measured total flow of 1,224 cfm. This position provided a stronger effect, especially when coupled with a plastic curtain to limit the localized flow of air back down the stairs (**Figure 12-1**, Tests D through I, see also photo in **Figure 12-2**). Under these conditions, whether the second story windows were open or closed had little apparent effect, perhaps because the envelope of this pre-1920 home is not tight (comparing Test G to other tests in the D through I series).

Column1	Test A	Test B	Test C	Test D	Test E	Test F	Test G	Test H	Test I
A.C.s on	X	X	X	X	X	X			X
A.C.s off							X	X	
Birdcage fans in windows	X								
Box fans in windows	X								
Basement door open	X								
2nd floor windows open			X				X		
2nd floor windows closed		X		X	X	X		X	X
Box fans at basement doorway		X	X	X	X	X	X	X	X
Plastic sheet over basement doorway				X	X	X	X	X	X
Birdcage fans in basement vents					X				
Cooler temperatures						X			
Basement HVAC vent closed								X	
Time	~9hrs	~20min	~3.5hrs	~15hrs	~11hrs	~36hrs	~92hrs	~48hrs	~8days

Figure 12-1. Fan test matrix.



Figure 12-2. Fan position in stairwell (note plastic sheet over doorway).

Based on the main study information and the initial fan test data, the test matrix (**Figure 12-1**) was iteratively refined. Test durations were lengthened as we gathered more confidence in the iterative design.

12.2.3 Fan Test Results and Discussion

As shown in **Figures 12-3** and **12-4**, the differential pressure and second-floor indoor radon concentration changed very rapidly (in less than 1 hour) after initiating fan testing. Two collocated box fans virtually instantaneously gave us a 1 to 3 Pascals deflection in the expected directions, such that a driving force

was created between deep and shallow soil gas and between subslab and basement air. Both the pressure and radon changes gave the appearance of a step function, terminating rapidly after the fans were shut off. This differential pressure change was in the range of typical seasonal variation for this and other houses (U.S. EPA, 1993a) but was not as large as the worst case observed at this site (compare results for the full year presented in Section 10.2). Note in **Figure 12-3**, for example, that large variations in subslab versus indoor differential pressure occurred during a 2-week period in late September when no fan tests were performed. However, the radon values attained during fan testing (e.g., the second-floor levels shown on **Figure 12-4**) were similar to the highest radon concentrations observed during any season in this structure. The basement radon concentrations (not shown) also were elevated to some extent during the fan tests but did not show as clear of a response to the fan on and off cycles as those on the second floor. This likely reflects that although operating the fans at the head of the basement stairs enhances the flow of soil gas containing radon into the basement, it also is discharging radon-laden air from the basement into the upstairs of the house.

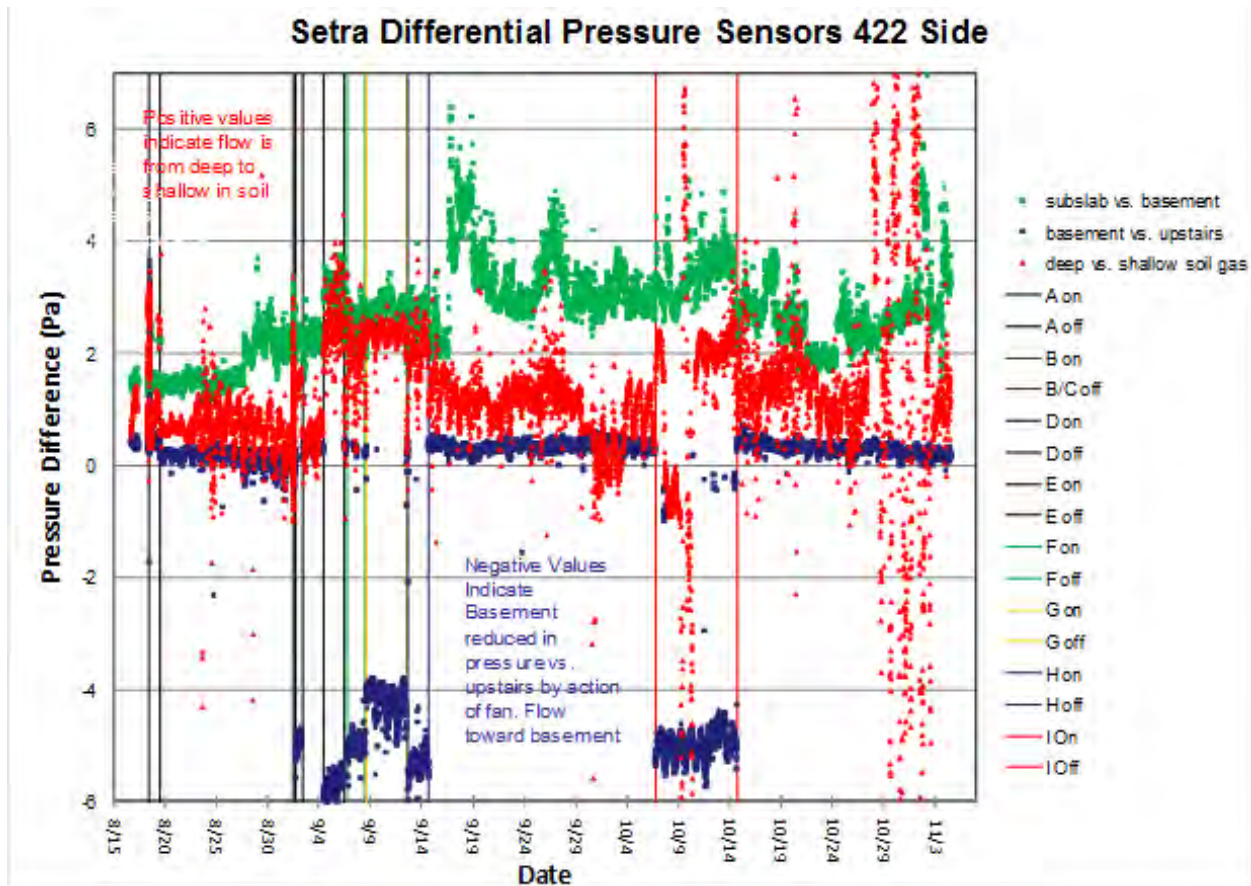

Figure 12-3. Differential pressure before, during, and after fan tests (fan tests denoted by vertical bars).

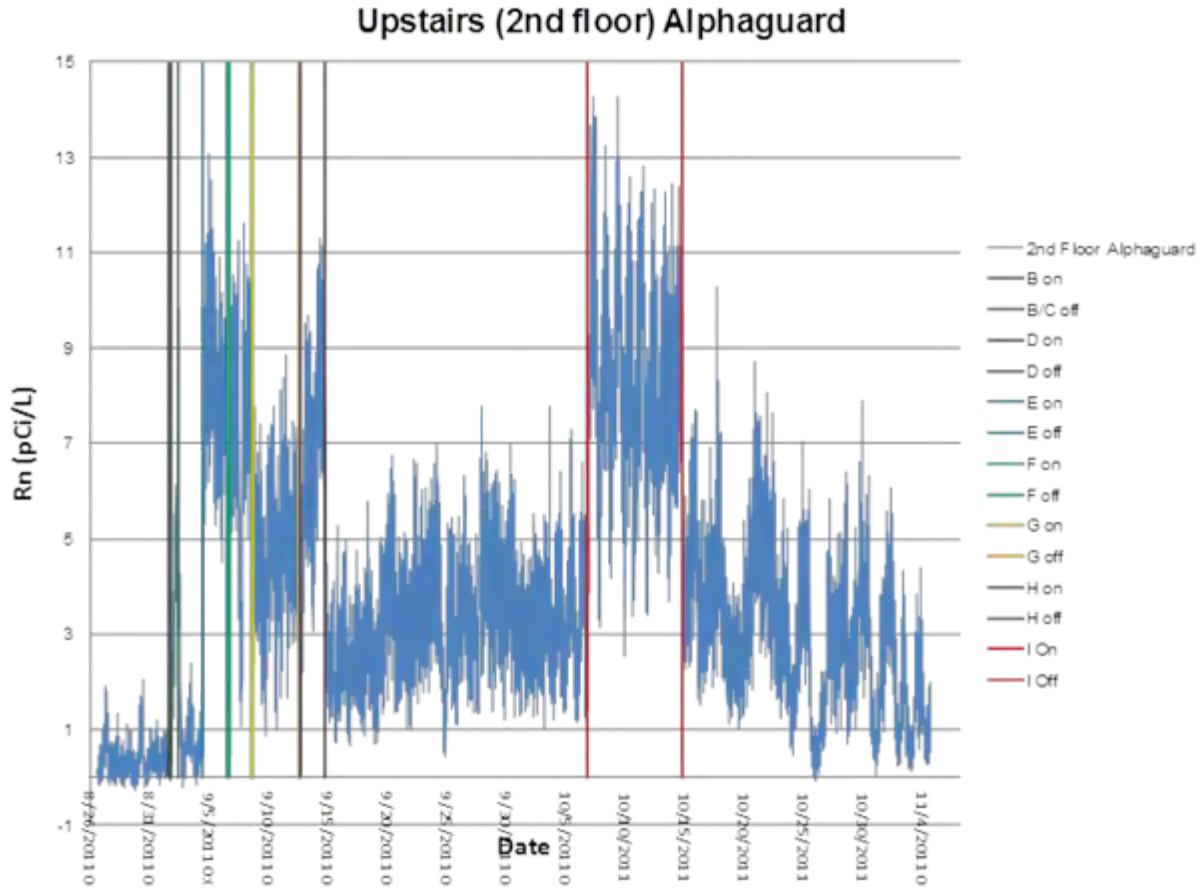

Figure 12-4. Radon on second floor before, during and after fan tests (fan tests denoted by vertical bars).

We expect that the flow into the basement will partially comprise soil gas and substantially comprise exterior air entering the basement through the exposed portion of the basement walls (**Figure 12-5**) because

- the basement in this duplex is only partially below ground (**Figure 12-6**),
- substantial pressure differentials have been measured between the basement and exterior that at some times indicate flow into the basement,
- only small pressure differentials exist between the upstairs and basement,
- tracer studies indicate that flow across the first floor/basement ceiling is generally upward (Section 10.1), and
- the basement concentrations of radon are much lower than the radon concentrations in the subslab.

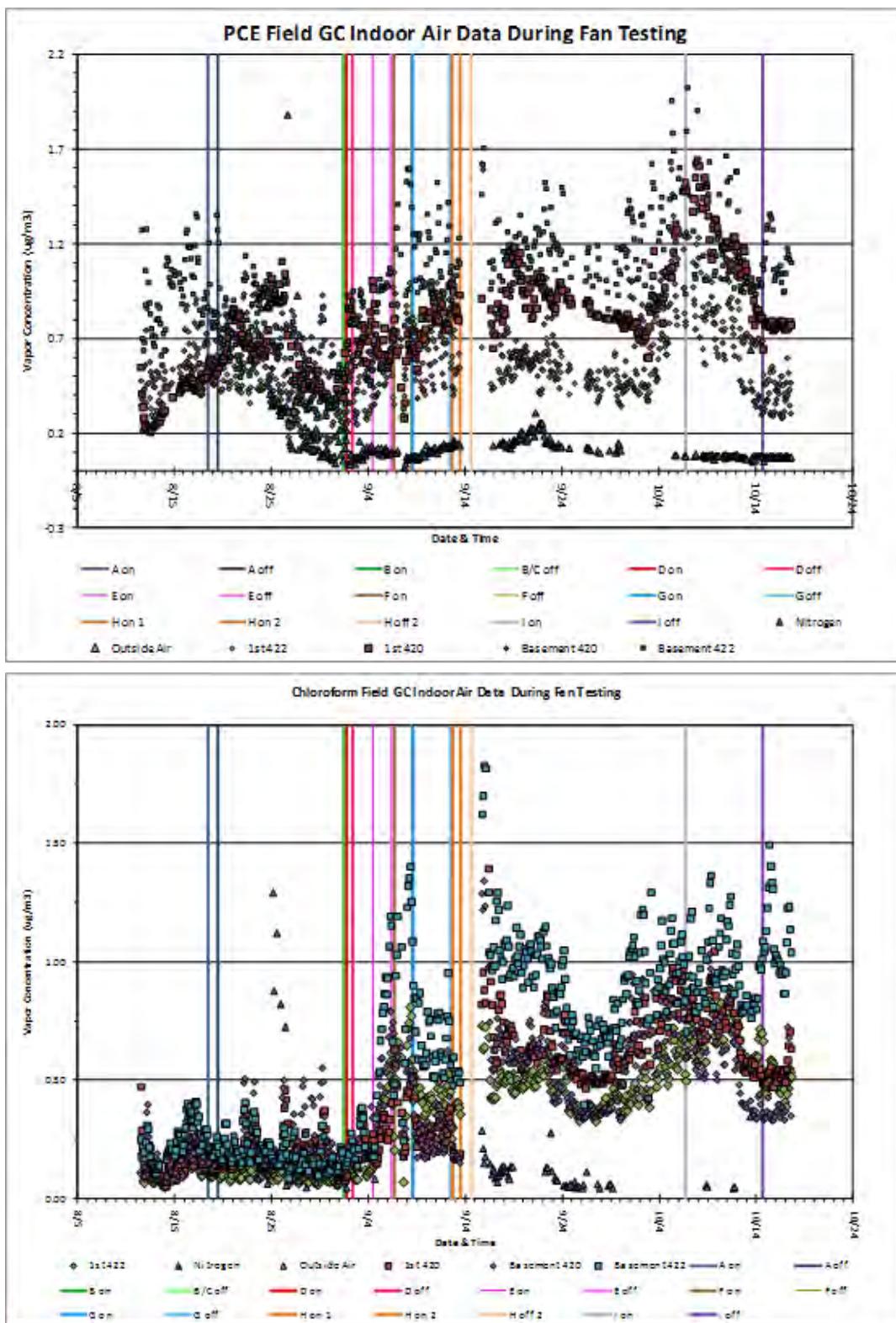

Figure 12-5. VOC Field instrument data before, during, and after fan tests (fan tests denoted by vertical bars).

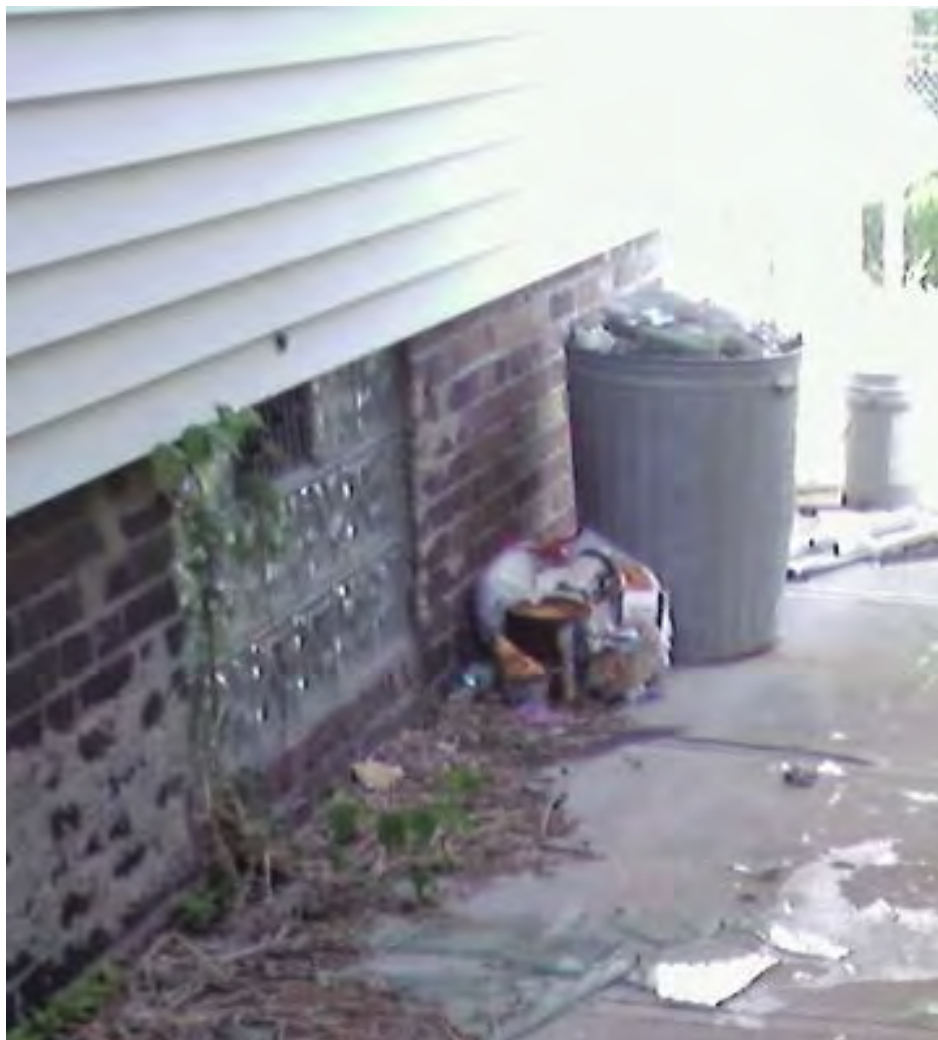

Figure 12-6. Note height of basement window and vent (sealed for this study).

In contrast, although the VOC data during the fan test (e.g., **Figure 12-5**) suggest that measureable increases in indoor concentrations can be induced with fan testing, this effect was less rapid and predictable. Subslab and soil gas VOC concentrations (**Figure 12-7**) did not generally markedly change during these short-term fan tests. Exceptions to this trend occurred at WP-3 for PCE and SGP2-9 as well as WP-3 for chloroform, each channel of which does show more than one discontinuity corresponding with the start or end of a fan test. Analysis of data, both from the on-site GC (**Figure 10-5**, Section 5.3) and time-integrated samples (collected with Method TO-15, **Figure 12-8**), suggests that although the fan operation increased VOC concentrations moderately over baseline, it did not increase concentrations to the highest levels observed under natural conditions. For example, the VOC levels in December and January were considerable higher than those observed during the fan testing (compare results in this section to Sections 5.1.1 and 5.3.1). **Figure 12-9** shows that the radon, PCE, and chloroform concentrations did not always move together during the fan testing.

The radon, VOC, and differential pressure datasets suggest that although the fans were operated to directly draw air out of the basement space, their effect may have been greater in increasing the flow of basement air upstairs, rather than increasing vapor intrusion and the basement indoor air concentrations.

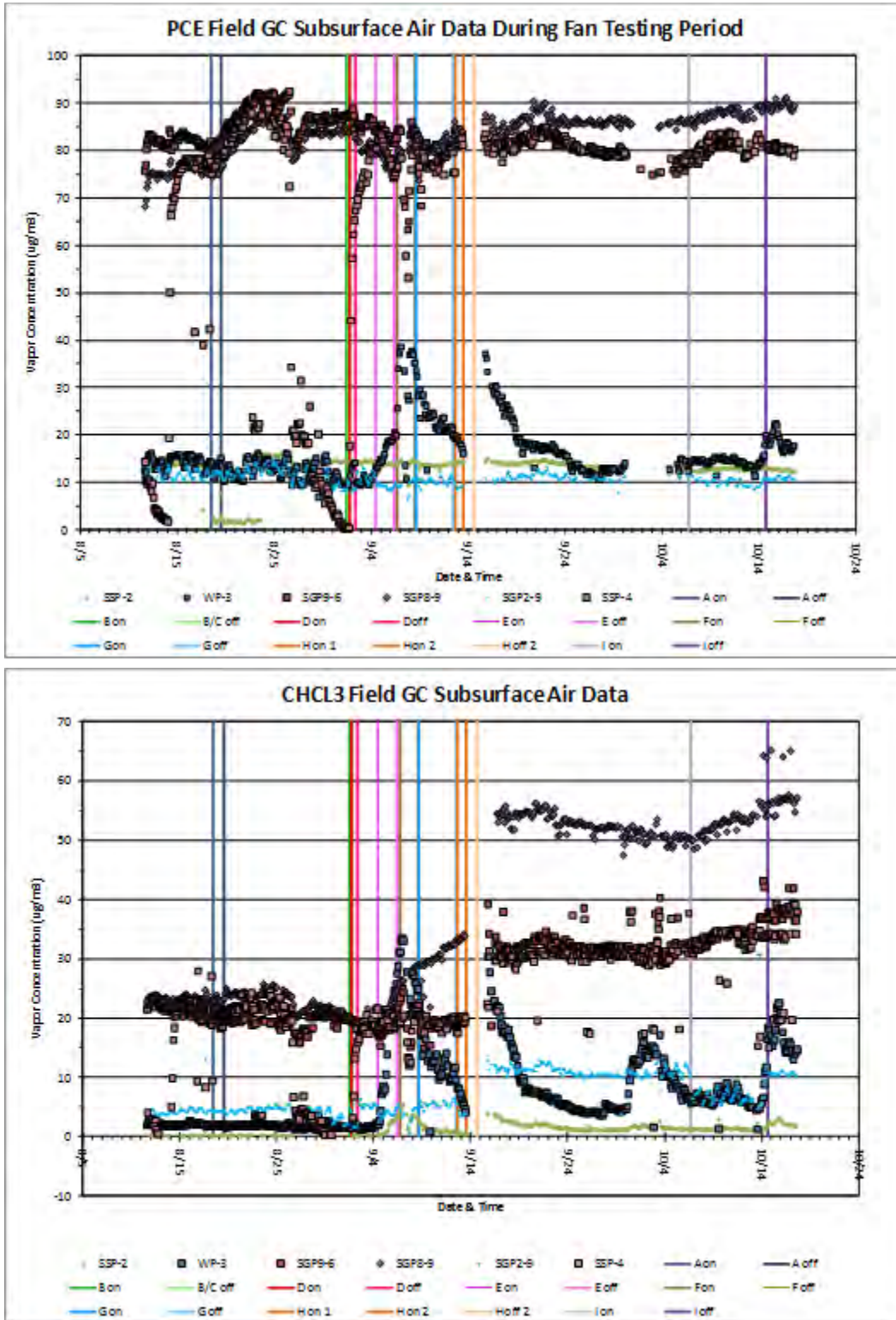

Figure 12-7. Subslab and soil gas VOC data during fan test period.

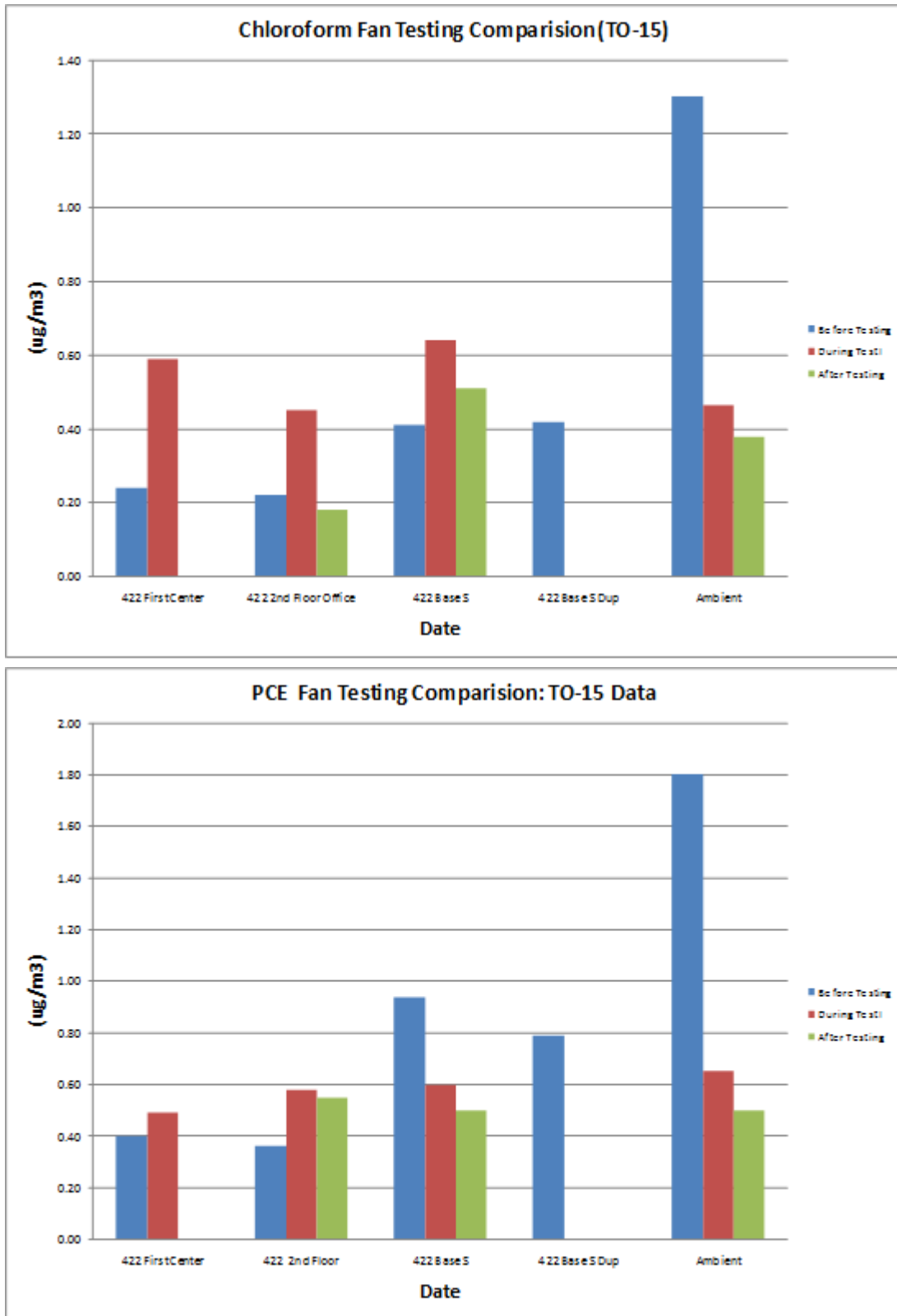

Figure 12-8. VOC data before, during, and after fan testing, Method TO-15.

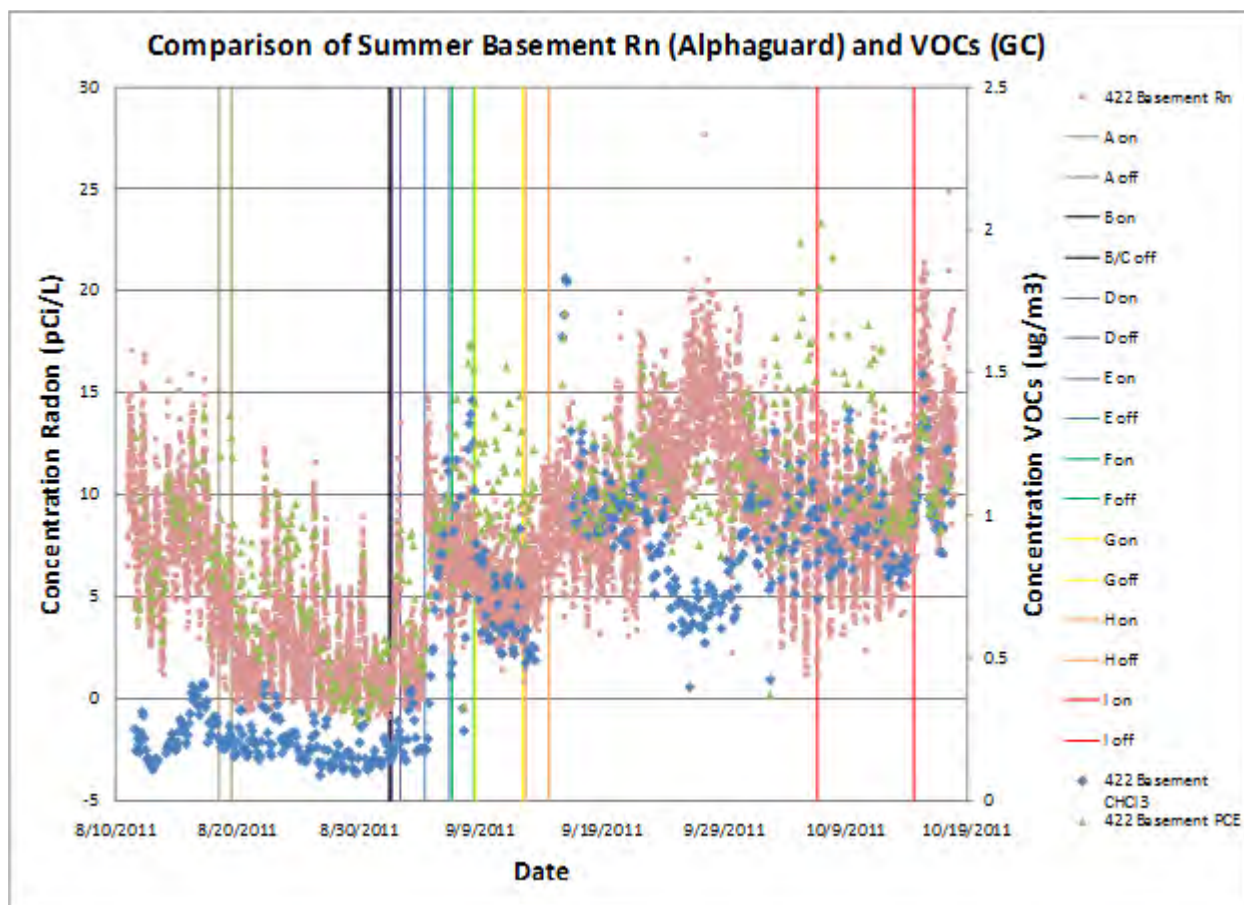

Figure 12-9. Comparison of fan test responses of radon, PCE, and chloroform in 422 basement.

12.2.4 Fan Test Lessons Learned

Achieving depressurization of a building is very sensitive to fan placement within the structure. Temporary plastic barriers can be effectively used to control flow pathways. Differential pressure monitoring at several locations during fan testing is valuable because results may not be fully predictable a priori and probably depend on the specific air sealing of the house envelope. Short-term (several days) induction of a differential pressure equivalent to worst case natural conditions may not provide worst case indoor air concentration for VOCs if there is significant seasonal variability in soil gas concentrations. It can, however, provide some confirmation that vapor intrusion is a significant pathway by increasing indoor concentrations. Results suggest that, in the house tested, the effects of fans on both pressure and concentration may not be as powerful as the natural forces that influence the variability of the intrusion of subsurface VOCs into indoor air and that VOC concentrations are not as greatly affected by fans as radon.

12.3 Testing Utility of Consumer-Grade Radon Device (Safety Siren Pro)

Schuver and Siegel (2011) have:

- highlighted the role of radon as a potential “general tracer of soil-gas entry”;
- pointed out that there are multiple benefits from minimizing soil gas entry (including reductions of problems attributable to moisture/mold, radon, and methane as well as reduction in VOCs); and

- advocated the active involvement of homeowners in observing the building-specific aspects of vapor intrusion at VOC sites, both as an educational tool (to help homeowners understand temporal and spatial variability) and a way to an efficient solution to which all stakeholders agree.

Thus, as an additional task in this project, we evaluated the ability of a widely available low-cost (\$129) consumer-grade radon detector based on an ionization chamber to provide a continuous indication of soil gas entry into the structure (Safety Siren Pro Series 3 manufactured by Family Safety Products Inc.).

12.3.1 Consumer-Grade Radon Device Test Objectives

The objective was stated as “evaluate the ability of a widely available low-cost (\$129) consumer grade radon detector based on an ionization chamber to provide a continuous indication of soil gas entry into the structure” (Safety Siren Pro Series 3¹ manufactured by Family Safety Products Inc.).

12.3.2 Consumer-Grade Radon Device Test Methods

The Safety Siren Pro Series 3 is a consumer-grade radon detection instrument that provides continuous real-time measurement based on an ionization chamber and requires little operator labor. An operating manual for this instrument is provided as Appendix B of the QAPP, Addendum 2. In this test, we sought to compare the performance of the safety siren to a well-accepted method (electrets). Secondly, we were able to compare the Safety Siren with the online Alphaguard data and the charcoal sampling with off-site analysis.

The following six stations were used for testing: the 422 basement south, the 422 basement north (downstairs Alphaguard), the 420 basement south, the 422 first floor, the 422 second floor office (upstairs Alphaguard), and the 420 first floor. The detector may be placed face up on a tabletop, countertop, or any flat surface where the ventilation slots will not be blocked. The detector must be kept dust free. A proper airflow must be maintained through the detector to obtain an air sampling representative of the local environment. It is impractical to use the Safety Siren for ambient measurement because of temperature and power issues. The manual restricts the operating environment to 0°C (32°F) to 40°C (104°F). We added an electret measurement location during the Safety Siren test period in the 422 second floor office for an additional comparison.

The Safety Siren has two displays—the “short term” is an average over the previous 7 days, and the “long term” is the average from time of last reset (up to 5 years). The numeric LED display shows the level of radon gas in pico Curies per liter (pCi/L). The display range is 0.0 to 999.9. Readings are available after a minimum of 48 hours of operation. We manually recorded the short-term reading at each of six indoor stations weekly. Data were assembled in spreadsheet form for comparison to electret and Alphaguard results. The audible alarm was muted.

Every 24 hours, the detector does a self-test. If there is a failure in this self-test, an error message will appear in the display window.

12.3.3 Consumer-Grade Radon Detector Test Results and Discussion

As shown in **Figure 12-10** and **Table 12-2**, the Safety Siren consumer-grade detector shows reasonably good agreement with an accepted professional method (electrets) over a range (1 to 5 pCi/L) useful for determining compliance with EPA’s recommend radon action level (4 pCi/L). Above 5 pCi/L, the Safety Siren tended to dramatically overestimate the radon concentration. Thus, this device would provide an indication of soil gas entry at low concentrations useful for radon management. In the higher range, the Safety Siren might overestimate the risk. Thus, the Safety Siren would be useful in showing a homeowner

¹ <http://www.radonzone.com/radon-detector.html>

when radon was being effectively excluded, but it might create a somewhat exaggerated impression of radon vapor intrusion variability if high concentration peaks occurred. Given the range of concentrations of this house and the accuracy range of the Safety Siren, it will be interesting to observe how the meters respond when a mitigation system is installed and begins operation in the test house as is planned in a later study.

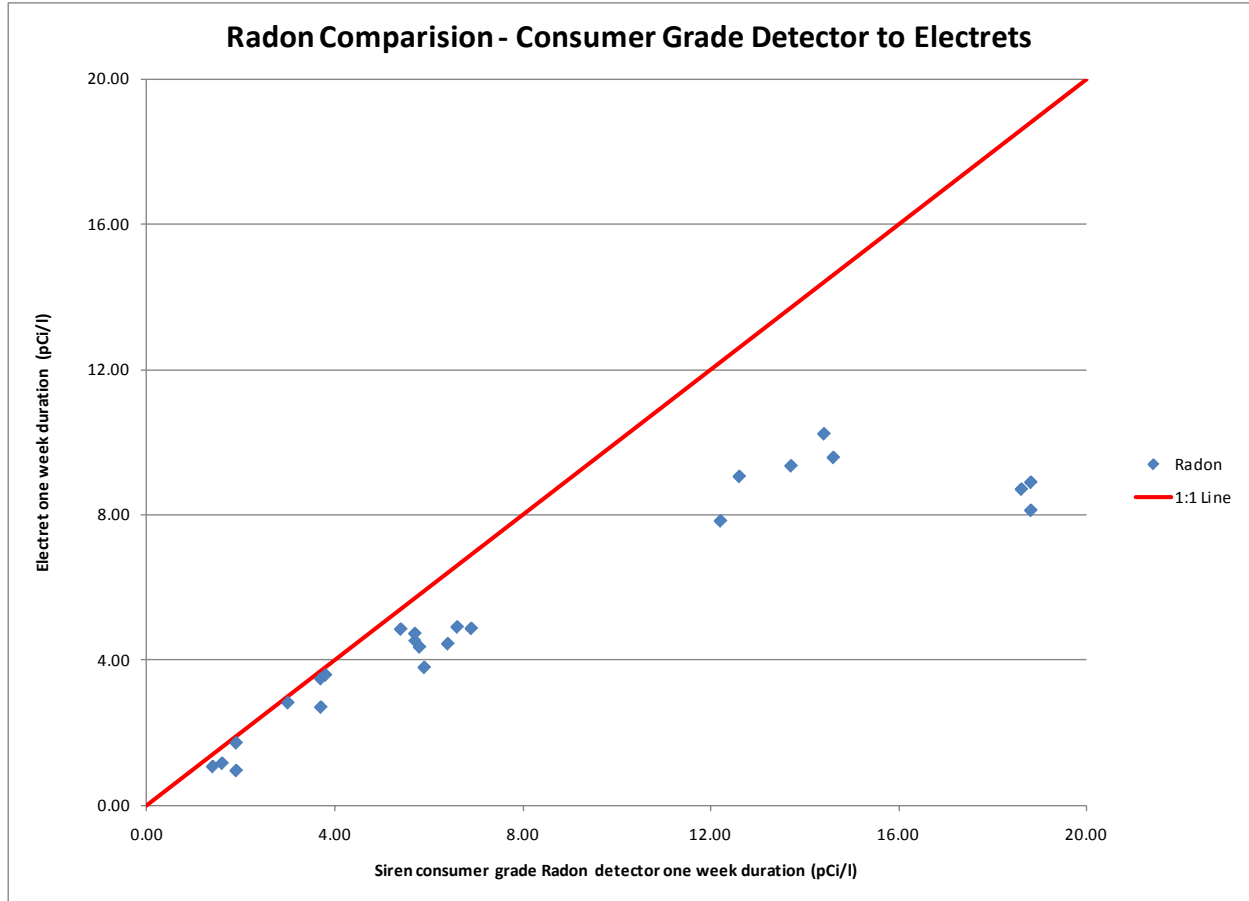

Figure 12-10. Comparison of electret and Safety Siren results.

Table 12-2. Comparison of Safety Siren, Alphaguard, and Electret Data

Location	Time	Date	Safety Siren (pCi/L)	Alphaguard (pCi/L)	Electrets (pCi/L)	Electret Duplicates (pCi/L)
1st Week Radon Comparison						
422 Second floor office	15:55	1/4/2012	6.6	~5	4.92	
422 First floor	16:03	1/4/2012	5.4		4.86	
422 Basement N	16:10	1/4/2012	14.4	~10	10.22	10.35
422 Basement S	16:08	1/4/2012	14.6		9.57	
420 First floor	16:13	1/4/2012	1.4		1.09	
420 Basement S	16:13	1/4/2012	3.7		2.72	

(continued)

Table 22-2. Comparison of Safety Siren, Alphaguard, and Electret Data (continued)

Location	Time	Date	Safety Siren (pCi/L)	Alphaguard (pCi/L)	Electrets (pCi/L)	Electret Duplicates (pCi/L)
2nd Week Radon Comparison						
422 Second floor office	13:59	1/11/2012	5.7	4.69	4.56	
422 First floor	14:12	1/11/2012	5.8		4.37	
422 Basement N	14:18	1/11/2012	12.6	8.78	9.05	9.11
422 Basement S	14:19	1/11/2012	18.6		8.70	
420 First floor	14:21	1/11/2012	1.6		1.18	
420 Basement S	14:25	1/11/2012	3.7		3.50	
3rd Week Radon Comparison						
422 Second floor office	11:25	1/18/2012	6.9	5.09	4.88	
422 First floor	11:26	1/18/2012	6.4		4.46	
422 Basement N	11:27	1/18/2012	13.7	9.73	9.34	9.73
422 Basement S	11:28	1/18/2012	18.8		8.89	
420 First floor	11:40	1/18/2012	1.9		0.98	
420 Basement S	11:42	1/18/2012	3.0		2.84	
4th Week Radon Comparison						
422 Second floor office	15:17	1/25/2012	5.7	4.79	4.74	
422 First floor	15:18	1/25/2012	5.9		3.81	
422 Basement N	15:20	1/25/2012	12.2	8.52	7.83	7.98
422 Basement S	15:21	1/25/2012	18.8		8.12	
420 First floor	15:25	1/25/2012	1.9		1.74	
420 Basement S	15:26	1/25/2012	3.8		3.60	
5th Week Radon Comparison						
422 Second floor office	14:41	2/1/2012	5.7	4.46	4.15	
422 First floor	14:40	2/1/2012	5.5		3.42	
422 Basement N	14:39	2/1/2012	12.6	7.71	8.24	8.03
422 Basement S	14:39	2/1/2012	18.9		7.26	
420 First floor	14:38	2/1/2012	1.0		0.25	
420 Basement S	14:36	2/1/2012	1.8		1.27	
6th Week Radon Comparison						
422 Second floor office	14:03	2/8/2012	5.2	4.78	4.58	
422 First floor	14:04	2/8/2012	5.3		4.48	
422 Basement N	14:15	2/8/2012	13.3	8.68	8.60	8.62
422 Basement S	14:15	2/8/2012	18.9		9.56	
420 First floor	14:10	2/8/2012	2.3		1.09	
420 Basement S	14:11	2/8/2012	5.4		2.40	

(continued)

Table 32-2. Comparison of Safety Siren, Alphaguard, and Electret Data (continued)

Location	Time	Date	Safety Siren (pCi/L)	Alphaguard (pCi/L)	Electrets (pCi/L)	Electret Duplicates (pCi/L)
7th Week Radon Comparison						
422 Second floor office	12:19	2/15/2012	5.6	4.80	4.41	
422 First floor	12:20	2/15/2012	6.0		4.15	
422 Basement N	12:23	2/15/2012	13.3	8.44	8.28	7.47
422 Basement S	12:25	2/15/2012	19.1		8.34	
420 First floor	12:28	2/15/2012	1.4		0.36	
420 Basement S	12:30	2/15/2012	3.0		1.94	
8th Week Radon Comparison						
422 Second floor office	14:28	2/22/2012	4.8	4.30	3.68	
422 First floor	14:29	2/22/2012	5.2		3.82	
422 Basement N	14:30	2/22/2012	12.0	7.74	6.08	5.82
422 Basement S	14:31	2/22/2012	18.1		6.56	
420 First floor	14:26	2/22/2012	1.4		0.42	
420 Basement S	14:25	2/22/2012	3.7		2.08	
9th Week Radon Comparison						
422 Second floor office	15:40	3/1/2012	6.1	4.74	3.97	
422 First floor	15:40	3/1/2012	6.2		3.88	
422 Basement N	15:41	3/1/2012	12.7	8.48	9.00	9.00
422 Basement S	15:42	3/1/2012	19.6		10.43	
420 First floor	15:46	3/1/2012	1.4		0.45	
420 Basement S	15:47	3/1/2012	2.1		2.56	

Table of Contents

13. Conclusions and Recommendations.....	13-2
13.1 Conclusions	13-2
13.1.1 Conclusions: Seasonal Variation and Influence of HVAC	13-2
13.1.2 Conclusions: The Relationship Between Subsurface and Indoor Air Concentrations.....	13-2
13.1.3 Conclusions: The Relationship Between Radon and VOCs.....	13-2
13.1.4 Conclusions: The Use of External Soil Gas Samples as a Surrogate Sampling Location.....	13-3
13.1.5 Conclusions: The Duration Over Which Passive Samplers (Solvent Extracted Radial Style Charcoal) Provided Useful Integration of Indoor Air Concentrations.....	13-3
13.1.6 Conclusions: Groundwater vs. Vadose Zone Sources as Controls on Indoor Concentrations at This Site.....	13-3
13.2 Practical Implications for Practitioners	13-4
13.2.1 Sampling to Characterize Seasonal Variations.....	13-4
13.2.2 Using Fan Induced Depressurization in Vapor Intrusion Studies	13-5
13.2.3 Performance of Temporary Sub-slab Sampling Ports	13-5
13.2.4 Performance of Consumer Grade Radon Detector	13-6
13.3 Recommendations	13-6
13.3.1 Recommendations For Vapor Intrusion Research Generally	13-6
13.3.2 Recommendations Regarding Further Data Collection at This Test Site.....	13-7

13. Conclusions and Recommendations

13.1 Conclusions

The conclusions of this study represent the fruit of an intensive study of a single early 20th century duplex in a particular geological setting—glaciofluvial deposits in Indianapolis, IN. Few other VOC vapor intrusion studies have collected a dataset of comparable detail, and those have been conducted in buildings of significantly different age or geological context.¹

13.1.1 Seasonal Variation and Influence of HVAC

- Lower VOC concentrations were observed in indoor air in summer. These VOC concentrations in indoor air are controlled not only by “building envelope-specific” factors, but they are also significantly influenced by seasonal variations in subsurface concentration distributions, especially in shallow/subslab soil gas where a weaker seasonal trend was observed.
- In indoor air, peak concentrations were seen in different months of the 2011 winter for PCE (January) and chloroform (March) on the first floor of this duplex. Temporal trends for chloroform and PCE differed markedly in fall 2011/winter 2012 between the heated and unheated sides of the duplex: the unheated side showed a much steeper decline in spring than the heated side. Thus, complex data patterns for multiple VOCs in the same structure can be expected even in the absence of occupant-related sources or activities.
- Stack-effect driving force calculations based on measurements of indoor/outdoor temperature differential were predictive of indoor air concentrations. These stack effects included not only the winter stack effect but also solar stack effects observed during summer and early fall. The cooling effect of window air conditioners appeared to provide some protection against vapor intrusion, at least for radon, during the summer months.
- A repeatable seasonal effect of higher concentrations during winter was seen for chloroform and radon, but not all winters are equal. Winter 2011 and winter 2012 were very different climactically, and peak PCE concentrations observed in January 2011 were not equaled in 2012. Inter-year climatic variations are well known even by lay stakeholders, but their role in vapor intrusion studies may be underappreciated.

13.1.2 The Relationship Between Subsurface and Indoor Air Concentrations

- PCE, chloroform, and radon have different spatial patterns in soil gas at this site.
- PCE and chloroform appear to have deep sources.
- Soil gas VOCs at some, but not all, high concentration sampling ports display a similar temporal pattern to that observed in indoor air, with higher concentrations during winter months.
- Sewer lines and laterals likely play some role in contaminant fate and transport in this system. Elevated concentrations of PCE and chloroform are present in the headspace of sewer gas. Their role in lateral transport through the vadose zone and into the subslab of the duplex will be elucidated through future geophysical studies.
- There is a strong seasonal component to the PCE and chloroform indoor concentrations (see Section 11). The seasonal component appears to be correlated to the strength of the stack effect, but it is not the only variable that controls indoor air concentrations.

¹ Johnson, Op. Cit. also numerous case studies compiled in U.S. EPA (2012c).

13.1.3 The Relationship Between Radon and VOCs

- Long-term (weekly and greater) radon concentrations in subslab air were more stable than VOC concentrations, presumably because the shallow soils themselves were the dominant source of radon and VOCs originate at a greater depth/distance.
- Radon concentrations in indoor air showed approximately an order of magnitude short term (< 1 day) variation—greater short-term variation than was observed for VOCs.
- The 1-week integration time dataset for radon had less seasonal variability than VOCs in indoor air.
- Statistical cross-correlation testing found that radon and VOCs were positively cross-correlated at several indoor air sampling locations (5% critical level). In laymen's terms, we are quite confident that when radon concentrations go up, VOC concentrations will also go up in indoor air. Some cross-correlations of radon and VOCs were observed at soil gas ports, but these cross-correlations were less consistent/strong.
- Radon provided a qualitative indication that soil gas was entering this house. Thus, radon would have been a useful aid to VOC data interpretation if the house had been occupied and had numerous potential indoor sources. However, long-term radon exposure would not have completely predicted VOC exposure in this house over all time scales.

13.1.4 The Use of External Soil Gas Samples as a Surrogate Sampling Location

- High concentrations of VOCs and radon were seen in tight loams directly under building (subslab ports and 6-ft soil gas ports) but not in external soil gas above the level of the basement floor (3.5 ft bls).
- External soil gas samples collected at 6 ft bls, the depth of the basement floor, had substantial VOC concentration variability and would have underpredicted subslab concentrations.
- In deep soil gas (13 and 16.5 ft), there was close agreement between the mean chloroform and radon concentrations at points underneath the building and outside of the building. In deep soil gas, PCE concentrations appeared lower on average and more variable for the points outside of the building than for the points beneath the building.

13.1.5 The Duration Over Which Passive Samplers (Solvent Extracted Radial Style Charcoal) Provided Useful Integration of Indoor Air Concentrations

- Excellent agreement was observed between numerical averages of successive 7-day exposure samples with the results of single passive samplers exposed for 14 days (almost always within +/- 30%) for all compounds, despite dramatic temporal variability. This suggests uniform uptake rates for these time periods.
- The PCE, benzene, hexane, and toluene passive samplers tested provide good integration over durations from 7 to 28 days. Chloroform integration was less effective for durations greater than 2 weeks.
- The PCE and toluene passive samplers provide good integration of concentrations over durations from 7 to 364 days.
- Temporal variability in 1-week duration indoor VOC samples over the course of a year of >20x were observed. For certain less-volatile compounds, passive samplers allow cost-effective acquisition of long-term average concentration data.
- Vapor pressure predicted well the relative durations over which different compounds could be collected with the passive samplers.

13.1.6 Groundwater vs. Vadose Zone Sources as Controls on Indoor Concentrations at this Site

- The potentiometric surface at this house responds within days to rain events.
- Chloroform concentration trends visually correlate with hydrogeological changes.
- Chloroform concentrations in soil gas peak have their highest concentrations just above the water table.
- Chloroform is present in highest concentration in deep soil gas. Substantial chloroform has been historically detected in groundwater on a site 200 ft to the southwest. Chloroform was also detected in groundwater at this house in preliminary sampling. Further studies are planned to determine if the lack of detections in recent groundwater samples on site indicate migration through deep soil gas from off-site sources or losses in the sampling and analysis process. Chloroform attenuation is substantial between the area just above the water table and the 6-ft-depth below the structure. Chloroform is also substantially attenuated between subslab air and indoor air.
- PCE is apparently widely spatially distributed in site groundwater at concentrations well below the current 5 µg/L MCL.² The calculated volatilization from these shallow groundwater concentrations matches observed deep soil gas concentrations. Only a moderate degree of attenuation occurs in those deep soil concentrations as they are drawn toward the basement of the structure. Substantial attenuation occurs in the upper 6 ft of the site external soil gas, which is composed of finer grained materials than the soils. Substantial attenuation also occurs across the building envelope between subslab and indoor air.
- The relative importance of the potential sources of PCE and chloroform—historic drycleaners, the adjacent commercial/industrial quadruplex, and storm sewers/drinking water disinfection—is unclear.

13.2 Practical Implications for Practitioners

In this section we present specific conclusions and observations that directly address common questions that arise in the investigation of vapor intrusion sites.

13.2.1 Sampling to Characterize Seasonal Variations

13.2.1.1 Indoor Air Sampling for Seasonal Variations

- Current guidance in NJ DEP (2012) calls for sampling in : “*Heating season is from November 1 to March 31 (Winter).*” NY (2006)³ also ties sampling to “*heating season*”
- Tying the sampling location to the heating season may not adequately represent seasonal worst case if soil gas concentrations increase gradually during the winter or are effected by spring high water.
- CA DTSC (2011)⁴ guidance formulation may be better on this point: “*At a minimum, sampling data should be obtained over two seasons; late summer/early autumn and late winter/early spring*”

² <http://water.epa.gov/drink/contaminants/index.cfm>

³ FINAL: Guidance for Evaluating Soil Vapor Intrusion in the State of New York October 2006, Prepared by: NEW YORK STATE DEPARTMENT OF HEALTH

⁴ *Final Guidance for the Evaluation and Mitigation of Subsurface Vapor Intrusion to Indoor Air (Vapor Intrusion Guidance)*. Department of Toxic Substances Control, California Environmental Protection Agency. October 2011

- Caution: high water levels at some sites may bring VOCs closer to the occupied space, but at other sites may represent the temporary occurrence of a fresh water lens.
- Short term variability of 2-5× was observed in indoor air (semihourly observations over a period of one week or less). The variability in this case appears to be less severe than the three orders of magnitude observed by Johnson et al. (2012) in another house under different building and geological conditions.

13.2.1.2 Soil Gas Sampling for Seasonal Variation

- Short term variability (semihourly observations over a period of a week) was quite low (<2x) in subslab and shallow soil gas ports. Basement wall ports are the exception and show more short term variability.
- Except for the wall ports, our results suggest changes in soil gas concentrations occur gradually over months. Therefore, 15-minute soil gas samples may be adequate, and 24-hour integration unnecessary.
- A significant, steady rise in soil gas concentrations over the course of a winter was observed; therefore, sampling at the beginning and end of winter may give substantially different results.

13.2.2 Using Fan Induced Depressurization in Vapor Intrusion Studies

- Achieving depressurization of a building is very sensitive to fan placement within the structure. Temporary plastic barriers can be effectively used to control flow pathways.
- Differential pressure monitoring at several locations during fan testing is valuable since results may not be fully predictable *a priori*.
- Short term (several days) induction of a differential pressure equivalent to worst case natural conditions may not provide worst case indoor air concentration for VOCs if there is significant seasonal variability in soil gas concentrations.
- In the house tested, the effects of fans on both pressure and concentration were not as powerful as the natural forces that influence the variability of the intrusion of subsurface VOCs into indoor air, and thus VOC concentrations were not as greatly affected by fans as radon concentrations.

13.2.3 Performance of Temporary Subslab Sampling Ports

- Under the conditions studied here, VOC and radon concentrations measured simultaneously in soil gas using nearly collocated temporary and permanent ports appeared to be independent of the type of port.
- The variability between nearly collocated temporary and permanent ports was much less than the spatial variability between different locations within the same residential duplex.
- The agreement of concentrations was achieved even though the clay portion of the seal of the temporary ports visibly desiccated and cracked. Post sampling leak test results suggested that this desiccation and cracking was not as detrimental to port seal performance as would have been expected and suggests that the Teflon tape portion of the seals was serving an important function.
- Post sampling leak tests are advisable (in addition to presampling leak tests) when temporary ports are used to collect a time integrated sample over a period of several hours.
- These results suggest that temporary subslab sampling ports can provide data equivalent to that collected from a permanent subslab sampling port at the same time. However, we caution that: (1) we tested only one type of seal material in one location, (2) the seals were installed by experts and rigorous quality control, and; thus, (3) these results may not apply to all types of temporary seals and all building foundations.

13.2.4 Performance of Consumer Grade Radon Detector

- The Safety Siren consumer grade detector shows reasonably good agreement with an accepted professional method (electrets) over a range of radon concentrations (1-5 pCi/L) useful for determining compliance with EPA's recommend Radon Action Level of 4 pCi/L. Above 5 pCi/L the Safety Siren detector tends to dramatically overestimate the radon concentration. Thus, this device would provide an indication of soil gas entry at low concentrations useful for radon management. In the higher range it might overestimate the risk.

13.3 Recommendations

13.3.1 Recommendations for Vapor Intrusion Research Generally

- A standardized quantitative format to describe the degree of variability in vapor intrusion studies would help advance scientific understanding and aid practitioners. Such a format could
 - allow the relative importance of temporal and spatial variability to be compared for a given site;
 - allow various intensely studied sites to be intercompared to determine the magnitude of variability to be expected in typical vapor intrusion applications; and
 - guide practitioners, regulators, and stakeholders in assessing the relative value of additional sampling rounds vs. additional sampling points.
- The use of stack-effect driving force calculations based on indoor-outdoor temperature differentials should be further explored as a practical tool in for monitoring temporal variability. These measurements can be made at extremely low cost with commercially available equipment.
- Because long exposure periods (up to one year) of VOC passive samplers appear promising in this study for certain less volatile compounds, we suggest that
 - attempts be made to replicate these results in other building types, geologic settings, and other contamination situations;
 - computational approaches be developed in which uptake rates used in data reporting are corrected not only for exposure temperature (as they currently are) but also for sampling duration (based on empirical results and/or vapor pressure). This would address one likely objection—that passive samplers have predictably consistent negative biases over long exposure periods; and
 - EPA-accepted methods (TO series) should be written for passive samplers in indoor air, potentially based on current UK or EU methods.
- Researchers should begin to compare the cost-effectiveness of multiple tools and strategies that could potentially be used to monitor or estimate long-term exposure in numerous structures subject to vapor intrusion. Passive VOC samplers, fan testing, and surrogates such as radon or indoor/outdoor temperature differential are all approaches that should be further developed and compared.
- Because the number of well-published studies of VOC vapor intrusion under controlled conditions is very small, additional studies should be undertaken that include frequent sampling of groundwater, soil gas, and indoor air over long durations. Additional structure types such as crawl space, slab on grade, mobile home, multifamily, and commercial should be included. Additional climatic conditions, such as tropical or coastal, should be included, along with different geologic settings.

13.3.2 Recommendations Regarding Further Study of this Test Site

- Further studies to better elucidate the exact routes of VOC migration through this test duplex would be valuable. Tracer studies could address this as well as providing insight into the rate at which VOCs and radon move through this system.
- Additional sampling at this site would help better establish the role of various potential sources in what is presumed to be a low concentration impacted groundwater plume. This has implications not only for local residents, but also for the management of potential vapor intrusion issues in other historic urban neighborhoods.
- Further studies to better establish the roles of sewer mains and laterals in this case would be valuable.
- Studies of this site that further elucidated deep soil gas attenuation processes, such as the greater attenuation of chloroform as compared with PCE would contribute to a fuller understanding of this site.
- 3-D numerical modeling of this site could help evaluate the utility of current state-of-the-art models of vapor intrusion processes.
- The duplex structure and existing dataset at this site provide opportunities for comparative studies of vapor intrusion investigation and mitigation techniques.

14. References

- Abreu, L.D., and P.C. Johnson. 2005. Effect of vapor source --building separation and building construction on soil vapor intrusion as studied with a three-dimensional numerical model. *Environmental Science and Technology* 39(12):4550–4561.
- Abreu, L.D., and P.C. Johnson. 2006. Simulating the effect of aerobic biodegradation on soil vapor intrusion into buildings: influence of degradation rate, source concentrations. *Environmental Science and Technology* 40(7):2304–2315.
- AFCEE (Air Force Center for Environmental Excellence). 2004. *Principles and Practices of Enhanced Anaerobic Bioremediation of Chlorinated Solvents*. Prepared for AFCEE, Brooks City-Base, TX. Available at http://costperformance.org/remediation/pdf/principles_and_practices_bioremediation.pdf.
- Arvela, H. 2008. Radonsafe Foundation, Moisture Prevention and Air Exchange in a Healthy Building. Finnish Research Programme on Environmental Health. Available at <http://www.ktl.fi/sytty/abstracts/arvela.htm>.
- ATSDR (Agency for Toxic Substances and Disease Registry). 1997. *Toxic Substances Portal – Toxicological Profile for Chloroform*. Available at <http://www.atsdr.cdc.gov/toxprofiles/tp.asp?id=53&tid=16>.
- Batterman, S., T. Metts, and P. Kalliokoski. 2002a. Diffusive uptake in passive and active absorbent sampling using thermal desorption tubes. *Journal of Environmental Monitoring* 4:870.
- Batterman, S., T. Metts, and P. Kalliokoski. 2002b. Low-flow active and passive sampling of VOCs using thermal desorption tubes: Theory and application at an offset printing facility. *Journal of Environmental Monitoring* 4:361–370.
- Begerow, J., E. Jermann, T. Keles, and L. Dunemann. 1999. Performance of two different types of passive samplers for the GC/ECD-FID determination of environmental VOC levels in air. *Fresenius Journal of Analytical Chemistry* 363:399–403.
- Bertoni, G., R. Tappa, and I. Allegrini. 2001. Internal consistence of the new “Analyst” Diffusive Sampler: A long term field test. *The Diffusive Monitor* 12:2–5.
- Bozkurt, O., K.G. Pennell, and E.M. Suuberg. 2007a. *Evaluation of Characterization Techniques for Vapor Intrusion Scenarios using a Three-Dimensional Computational Fluid Dynamics (CFD) Model*. Air and Waste Management Association, Providence, RI, September.
- Bozkurt, O., K.G. Pennell, and E.M. Suuberg. 2007b. *Characterizing Vapor Intrusion Scenarios Using a Computational Fluid Dynamics Model*. ACS National Meeting. Boston, MA. August.
- Brenner, D. 2007. *Effect of Meteorological and Site Conditions on, and Relationship of Diurnal Variation to, Vapor Intrusion at NASA Ames Research Center*. Conference Proceeding from Vapor Intrusion: Learning from the Challenges-Air and Waste Management Association (AWMA), Providence, RI.
- Brown, V., and D. Crump. 1993. Appropriate sampling strategies to characterize VOCs in indoor air using diffusive samplers. Pp. 241–249 in *Proceedings of International Conference on VOCs*, London, October 27–28.
- Bruno, P., M. Caputi, M. Caselli, G. de Gennaro, and M. de Rienzo. 2005. Reliability of a BTEX radial diffusive sampler for thermal desorption: Field measurements. *Atmospheric Environment* 39:1347–1355.

- Cao, X.L., and C.N. Hewitt. 1994. Study of the degradation by ozone of adsorbents and hydrocarbons adsorbed during the passive sampling of air. *Environmental Science and Technology* 28:757–725.
- Carr, D.B., P.G., Laurent, C. Levy, A.H. Horneman. 2011. *Stylistic Modeling of Vadose Zone Transport Insight into Vapor Intrusion Processes*. Presented at the AEHS Workshop: Addressing Regulatory Challenges in Vapor Intrusion. A State of the Science Update. San Diego CA, March 15.
- Case, J., and K. Gorder. 2006. *The Investigation of Vapor Intrusion at Hill AFB*. Conference Proceeding from Vapor Intrusion: The Next Great Environmental Challenge—An Update. Air and Waste Management Association (AWMA), Los Angeles, CA.
- Cleveland, W.S. 1981. LOWESS: A program for smoothing scatterplots by robust locally weighted regression. *The American Statistician* 35 (1): 54.
- Cleveland, W.S, and S.J. Devlin. 1988. Locally-weighted regression: an approach to regression analysis by local fitting. *Journal of the American Statistical Association* 83 (403): 596–610.
- Cocheo, C., C. Boaretto, D. Pagani, F. Quaglio, P. Sacco, L. Zaratin, and D. Cottica. 2009. Field evaluation of thermal and chemical desorption BTEX radial diffusive sampler Radiello® compared with active (pumped) samplers for ambient air measurements. *Journal of Environmental Monitoring* 11:297–306.
- Cody, R.J., A. Lee, and R. Wiley. 2003. Use of Radon Measurements as a Surrogate for Relative Entry Rates of Volatile Organic Compounds in the Soil Gas. Presented at the AWMA Conference on Indoor Air Quality Problems and Engineering Solutions. Research Triangle Park, NC, July 21–23.
- Colby College. 2009. *Regression: Patterns of Variation*. Colby College Biology Department. Available at <http://www.colby.edu/biology/B117x/regression.html>.
- Coyne, L. 2010. Personal communication. SKC, Inc. August 17.
- Dawson, H. 2008. *US EPA's Vapor Intrusion Database - Preliminary Evaluation of Attenuation Factors for Chlorinated VOCs in Residences*. U.S. EPA Office of Superfund Remediation and Technology Innovation (OSRTI).
- Dawson, H., and H. Schuver. 2010. *US EPA's Vapor Intrusion Database: Preliminary Evaluation of Attenuation Factors for Chlorinated VOCs in Residences*. Presented at the 20th Annual International Conference on Soils, Sediments, Water and Energy, March 16.
- DePersio, T., and J. Fitzgerald. 1995. Guidelines for the Design, Installation, and Operation of Sub-Slab Depressurization Systems. Massachusetts Department of Environmental Protection, Northeast Regional Office. Available at <http://www.mass.gov/dep/cleanup/laws/ssd1e.pdf>.
- Dickson, J., A. Lonegran, and R. Stetson. 2010. Characterization of multiple chlorinated solvent plumes due to the impact of TCE screening level reduction. *International Journal of Soil, Sediment and Water* 3(2):Section 11.
- Dietz, R.N., and E.A.Cote. 1982. Air infiltration measurements in a home using convenient perfluorocarbon tracer technique. *Environment International* 8(1-6):419–433.
- Dietz, R.N., et al. 1986. Detailed description and performance of a passive perfluorocarbon tracer system for building ventilation and air exchange measurements. Pp. 203–254 in *Measured Air Leakage of Buildings: A Symposium*. Heinz R. Trechsel, Peter L. Lagus, ASTM Committee E-6 on Performance of Building Constructions Contributor Heinz R. Trechsel, Peter L. Lagus. Published by ASTM International.
- DiGiulio, D., C. Paul, R. Cody, R. Willey, S.Clifford, P. Kahn, R. Mosley, A. Lee, and K. Christensen. 2006. *Assessment of Vapor Intrusion in Homes near the Raymark Superfund Site Using Basement*

- and Subslab Air Samples*. EPA/600/R-05/147. U.S. EPA Office of Research and Development, Ada, OK. March.
- Distler, M., and P. Mazierski “Soil Vapor Migration Through Subsurface Utilities”, Proceedings 2010 AWMA Vapor Intrusion Specialty Conference.
- Eklund, B., and D. Borrows. 2009. Prediction of indoor air quality from soil-gas data at industrial buildings. *Groundwater Monitoring and Remediation* 29(1):118–125.
- Environmental Quality Management. 2004. *Users Guide for Evaluating Subsurface Vapor Intrusion into Buildings*. Prepared for US EPA under EPA Contract Number: 68-W-02-33, WA No. 004, PN 030224.0002. Available at http://www.epa.gov/oswer/riskassessment/airmodel/pdf/2004_0222_3phase_users_guide.pdf.
- Folkes, D., W. Wertz, J. Kurtz, and T. Kuehster. 2009. Observed spatial and temporal distributions of CVOCs at Colorado and New York vapor intrusion sites. *Ground Water Monitoring & Remediation* 29(1):70–80.
- Forbes, J., J. Havlena, M. Burkhard, and K. Myers. 1993. Monitoring of VOCs in the deep vadose zone using multi-port soil gas wells and multi-port soil gas/ground-water wells. Pp. 557–571 in *Proceedings of the Seventh National Symposium on Aquifer Restoration, Ground-water Monitoring, and Geophysical Methods*, National Ground Water Association, Dublin, OH.
- Garbesi, K., and R.G. Sextro. 1989. Modeling and field evidence of pressure-driven entry of soil gas into a house through permeable below-grade walls. *Environmental Science and Technology* 23(12):1481–1487.
- Greiner, M.A., and R.M. Franza. 2003. Barriers and bridges for successful environmental technology transfer. *The Journal of Technology Transfer* 28(2):167–177(11).
- GSI Environmental. 2008. *Final Report: Detailed Field Investigation of Vapor Intrusion Processes*. ESTCP Project ER-0423, September.
- Hall, S.K., J. Chakraborty, and R.J. Ruch. 1997. *Chemical Exposure and Toxic Responses*. Boca Raton, FL: CRC Press.
- Hass, B.S., and R. Herrmann. 1998. Tracing volatile organic compounds in sewers. *Water Science and Technology* 37(1):295–301.
- Hayes, H. 2008. Air Toxics Ltd., personal communication to Chris Lutes, ARCADIS, August.
- Helsel, D.R. 2005. *Nondetects and Data Analysis: Statistics for Censored Environmental Data*. Hoboken, NJ: Wiley.
- Howard, P.H., R.S. Boethling, W.F. Jarvis, W.M. Meylan, and E.M. Michalenko. 1991. *Handbook of Environmental Degradation Rates*. Chelsea, MI: Lewis Publishers, Inc.
- Hui, S.C. 2003. *Lecture: Air Movement and Natural Ventilation*. Department of Mechanical Engineering, The University of Hong Kong. Used by Permission from Dr. Hui. Available at <http://www.arch.hku.hk/teaching/lectures/airvent/sect03.htm>.
- IndyGov. 2012. *My Neighborhood*. Available at <http://maps.indy.gov/myneighborhood/>.
- ITRC (Interstate Technology and Regulatory Council). 2007. Vapor Intrusion Pathway: A Practical Guideline. Prepared by The Interstate Technology & Regulatory Council Vapor Intrusion Team. Available at <http://www.itrcweb.org/documents/VI-1.pdf>.
- Johnson, P.C., and R.A. Ettinger. 1991. Heuristic Model for Predicting the Intrusion Rate of Contaminant Vapors Into Buildings. *Environmental Science and Technology* 25:1445–1452.

- Johnson, Paul C., et al. 2012. *Vapor Intrusion Above a Dilute CHC Plume: Lessons-Learned from Two Years of Monitoring*. Presented at AEHS Conference San Diego.
- Jury, W.A., D. Russo, G. Streile, and H.E. Abd. 1990. Evaluation of volatilization by organic chemicals residing below the soil surface. *Water Resources Research* 26(1):13–20.
- Koontz, M.D., and H.E. Rector. 1995. *Estimation of Distributions for Residential Air Exchange Rates*. EPA Contract No. 68-D9-0166, Work Assignment No. 3-19. U.S. EPA Office of Pollution Prevention and Toxics. Washington, DC.
- Krewski, D., R. Mallick, J.M. Zielinski, and E.G. Létourneau. 2005. Modeling seasonal variation in indoor radon concentrations. *Journal of Exposure Analysis & Environmental Epidemiology* 15(3):234–243.
- Kuehster, T.E., D.J. Folkes, and E.J. Wannamaker. 2004. *Seasonal Variation of Observed Indoor Air Concentrations due to Vapor Intrusion*. Presented at the Midwestern States Risk Assessment Symposium, Indianapolis, IN.
- Kurtz, J.P., and D.J. Folkes. 2008. *Empirical Data on Lag Time for Vapor Intrusion from a Chlorinated VOC Groundwater Plume*. Presented at AEHS San Diego Conference, March 12.
- Lau, P. 2008. *Calculation of flow rate from differential pressure devices – orifice plates*. Presented to the European Metrology Association for Thermal Energy Measurement, August 2–4.
- Lee, A., K. Baylor, P. Reddy, and M. Plate. 2010. *EPA Region 9’s RARE opportunity to Improve Vapor Intrusion Indoor Air Investigations*. Presented at the 20th Annual International Conference on Soils, Sediments, Water and Energy, March 16.
- Linn, W., L. Appel, R. DeZeeuw, P. Doorn, J. Doyon, T. Evanson, J. Farrell, D. Hanson, R. Jurgens, J. So, C. Spiegel, D. Switek, and S. Yankey. 2010. *Conducting Contamination Assessment Work at Drycleaning Sites*. State Coalition for Remediation of Drycleaners. Available at <http://www.drycleancoalition.org/download/assessment.pdf>.
- Loureiro, C.O., and L.M. Abriola. 1990. Three-dimensional simulation of radon transport into houses with basements under constant negative pressure. *Environmental Science and Technology* 24(9):1338–1348.
- Luo, H., P. Dahlen, P. Johnson, T. Creamer, T. Peargin, P. Lundegard, B. Hartman, L. Abreau, and T. McAlary. 2006. *Spatial and temporal variability in hydrocarbon and oxygen concentrations beneath a building above a shallow NAPL source*. Presented at the Battelle Conference on Remediation of Chlorinated and Recalcitrant Compounds, Monterey, CA, May.
- Luo, H., P. Dahlen, P.C. Johnson, T. Peargin, and T. Creamer. 2009. Spatial variability of soil-gas concentrations near and beneath a building overlying shallow petroleum hydrocarbon-impacted soils. *Ground Water Monitoring & Remediation* 29(1):81–91.
- Lutes, C.C., R. Uppencamp, C. Singer, L. Abreu, R. Mosley, and D. Greenwell. 2009. *Radon Tracer as a Multipurpose Tool to Enhance Vapor Intrusion Assessment and Mitigation*. Poster presented at the Partners in Environmental Technology Technical Symposium and Workshop, Washington DC, December.
- Lutes, C.C., R. Uppencamp, H. Hayes, D. Greenwell, and R. Mosley. 2010. *Long-term Integrated Samplers for Indoor Air and Sub-slab Soil Gas at VI Sites*. Presented at the 2010 Battelle Conference, Monterey, CA.
- MacLeod, G., and J.M. Ames. 1986. Comparative assessment of the artifact background on thermal desorption of Tenax GC and Tenax TA. *Journal of Chromatography* 355:393–398.

- MADEP. 2002. *Indoor Air Sampling and Evaluation Guide*. Boston, MA: Commonwealth of Massachusetts Executive Office of Environmental Affairs, Office of Research and Standards, Department of Environmental Protection.
- Marotta, L., M. Snow, and S. Varisco. 2012. *Extending the Hydrocarbon Range above Naphthalene for Soil Vapor and Air Samples Using Automated Thermal Desorption/Gas Chromatography/Mass Spectrometry (ATD/GC/MS)*. Presented at National Environmental Monitoring Conference, Washington DC, August 6–10.
- McAlary, T.A., P. Dollar, P. de Haven, R. Moss, G. Wilkinson, J. Llewellyn, and D. Crump. 2002. *Assessment of subsurface vapour transport through Triassic sandstone and quarry fill into indoor air in Weston Village, Runcorn*. Presented at Indoor Air 2002, Monterey, CA.
- McHugh, T. E., and Nickels, T. N. 2007. *Evaluation of Spatial and Temporal Variability in VOC Concentrations at Vapor Intrusion Investigation Sites*. Conference Proceeding from Vapor Intrusion: Learning from the Challenges-Air and Waste Management Association (AWMA), Providence, RI.
- McHugh, T., P. De Blanc, and R. Pokluda. 2006. Indoor air as a source of VOC contamination in shallow soils below buildings. *Soil and Sediment Contamination* 15:103–22.
- McHugh, T.E., T.N. Nichols, and S. Brock. 2007. Evaluation of spatial and temporal variability in VOC concentrations at vapor intrusion investigation sites. Pp. 129–142 in *Proceeding of Air & Waste Management Association's Vapor Intrusion: Learning from the Challenges*, Providence, RI, September 26–28.
- Mosley, R.B. 2007. *Use of Radon to Establish a Building-specific Sub-slab Attenuation Factor for comparison with Similar Quantities measured for Other Vapor Intrusion Contaminants*. Presented at the National Environmental Monitoring Conference, Cambridge, MA, August 19–25.
- Mosley, R.B., D. Greenwell, A. Lee, K. Baylor, M. Plate, and C. Lutes. 2008. *Use of Integrated Indoor Radon and Volatile Organic Compounds (VOCs) to Distinguish Soil Sources from Above-Ground Sources*. Extended abstract and oral presentation, AWMA Symposium on Air Quality Measurement and Technology, Chapel Hill NC, November 6.
- Mosley, R.B., D. Greenwell, and C.C. Lutes. 2010. Use of Integrated Indoor Concentrations of Tracer Gases and Volatile Organic Compounds (VOCs) to Distinguish Soil Sources from Above-Ground Sources. Poster presented at the Seventh International Remediation of Chlorinated and Recalcitrant Compounds Conference, Monterey, CA, May 24–27.
- Murry, D.M., and D.E. Burmaster. 1995. Residential air exchange rates in the United States: Empirical and estimated parametric distributions by season and climatic region. *Risk Analysis* 15(4):459–65.
- National Weather Service. 2012. *Excessive Heat - An Underrated Problem*. National Weather Service Regional Office, Central Regional Headquarters. Available at <http://www.crh.noaa.gov/Image/lx/wcm/Heat/ExcessiveHeat.pdf>.
- Nazaroff, W.W. 1988. Predicting the rate of ²²²Rn entry from soil into the basement of a dwelling due to pressure-driven air flow. *Radiation Protection Dosimetry* 22(1/4):199–202.
- Nazaroff, W.W., and A.V. Nero (Eds.). 1988. *Radon and Its Decay Products in Indoor Air*. New York: John Wiley and Sons.
- Nazaroff, W.W., S.R. Lewis, S.M. Doyle, B.A. Moed, and A.V. Nero, 1987. Experiments on pollutant transport from soil into residential basements by pressure-driven airflow. *Environmental Science & Technology* 21:459–466.

- Neptune and Company. 2007. *Report for 2007 Annual Vapor Intrusion Sampling for Buildings N210 and 19 and Additional Baseline Sampling for Building 16*. Prepared for ISSi/SAIC NASA Ames Research Center Moffett Field, California 94035-1100 Neptune Project No 09501.
- New York Times. 2012. *Toxic Waters: Indianapolis Water*. May 26. Available at <http://projects.nytimes.com/toxic-waters/contaminants/in/marion/in5249004-indianapolis-water>.
- Newton, E., and R. Rudela. 2007. Estimating correlation with multiply censored data arising from the adjustment of singly censored data. *Environmental Science and Technology* 41(1):221–228.
- NJ DEP (New Jersey Department of Environmental Protection). 2012. *Draft Vapor Intrusion Guidance*. January.
- Odabasi, M. 2008. Halogenated volatile organic compounds from the use of chlorine-bleach-containing household products. *Environmental Science and Technology* 42:1445–1451.
- Oury, B., F. Lhuillier, J. Protois, and Y. Moréle. 2006. Behavior of the GABIE, 3M3500, PerkinElmer Tenax TA, and RADIELLO 145 diffusive samplers exposed over a long time to a low concentration of VOCs. *Journal of Occupational and Environmental Hygiene*: 547–557.
- Parker, G.B. 1985. *PNL-SA-13507*. Presented at Conference on Conservation in Buildings: Northwest Perspective, Butte MT, May 20. Abstract available at http://www.osti.gov/energycitations/product.biblio.jsp?osti_id=5567459.
- Pennequin-Cardinala, A. et al. 2005. Performances of the Radiellos diffusive sampler for BTEX measurements: Influence of environmental conditions and determination of modeled sampling rates. *Atmospheric Environment* 39:2535–2544.
- R Development Core Team. 2012. *R: A language and environment for statistical computing*. R Foundation for Statistical Computing, Vienna, Austria. Available at <http://www.R-project.org>.
- Razali, N., and Y.B. Wah. 2011. Power comparisons of Shapiro-Wilk, Kolmogorov-Smirnov, Lilliefors and Anderson-Darling tests. *Journal of Statistical Modeling and Analytics* 2(1):21–33. Available at <http://instatmy.org.my/downloads/e-jurnal%202/3.pdf>. Retrieved 5 June 2012.
- Revzan K.L., W.J. Fisk, and A.J. Gadgil. 1991. Modeling Radon Entry into Houses with Basements: Model Description and Verification. *Indoor Air* 2:173–189.
- Robinson A.L., and R.G. Sextro. 1997. Radon entry into buildings driven by atmospheric pressure fluctuations. *Environmental Science and Technology* 31:1742–1748.
- Robinson, A.L., R.G. Sextro, and W.J. Riley. 1997. Soil-gas entry into houses driven by atmospheric pressure fluctuations - the influence of soil properties. *Atmospheric Environment* 31:1487–1495.
- Ryan, J.V, P.M. Lemieux, and W.T Preston. 1998. Near-real-time measurement of trace volatile organic compounds from combustion processes using an on-line gas chromatograph. *Waste Management* 18(6):403–410.
- Scheeringa, K., and K. Hudson. 2011–2012. *Monthly Climate Summaries*. Indiana State Climate Office. Available at <http://iclimate.org/summary.asp>.
- Schumacher, B., J. Zimmerman, G. Swanson, J. Elliot, and B. Hartman. 2010. *Field Observations on Ground Covers/Buildings*. Presented at the 20th Annual International Conference on Soils, Sediments, Water and Energy, March 16.
- Schuver, H., and L. Siegel. 2011. Vapor Intrusion: Involved-Stakeholder Awareness of the Uncertainty (and Multiple Benefits of Controls). Community Involvement Training Conference, Crystal City VA, July. Available at

http://epa.gov/ciconference/download/presentations/Wed_OpenTime%20Session_Salon6_Schuver_Siegel.pdf.

- Schuver, H.J., and R.B. Mosley. 2009. *Investigating vapor intrusion with confidence and efficiency (some observations from indoor air-based radon intrusion studies)*. AWMA Vapor Intrusion 2009, San Diego, CA.
- Sigma-Aldrich. 2012. *Radiello manual, Volatile organic compounds (VOCs) chemically desorbed with CS₂, Supelco edition*. Available at http://www.sigmaaldrich.com/content/dam/sigma-aldrich/docs/Supelco/Application_Notes/radiello_d1_d6.pdf, accessed August 2012.
- Smajstrla, A.G., and D.S. Harrison. 1998. Tensiometers for Soil Moisture Measurement and Irrigation Scheduling. CIR487. Agricultural and Biological Engineering Department, Florida Cooperative Extension Service, Institute of Food and Agricultural Sciences, University of Florida. Available at <http://edis.ifas.ufl.edu/ae146>.
- The Polis Center. 2012. *Study Neighborhoods from the Project on Religion and Urban Culture: Mapleton-Fall Creek*. Footnote 2. The Polis Center, Indianapolis, IN. Available at http://www.polis.iupui.edu/RUC/Neighborhoods/MapletonFallCreek/MFCNarrative.htm#_ftn2.
- Truesdale, R., H. Dawson, and I. Hers. 2005. *Vapor Intrusion Database Status and Updates*. Presented at The EPA/AEHS Conference, San Diego, CA, March 14. Available at http://iavi.rti.org/attachments/Resources/1045_-_Truesdale_Vapor_Intrusion_Database_Status_and_Updates.pdf.
- U.S. EPA (Environmental Protection Agency). 1990. *NAREL standard operating procedures for Radon-222 measurement using diffusion barrier charcoal canisters*. EPA 520/5-90/032 Stock Number PB91-179002. U.S. EPA National Air and Radiation Environmental Lab., Montgomery AL.
- U.S. EPA (Environmental Protection Agency). 1992. *Indoor Radon and Radon Decay Product Measurement, Device Protocols*. EPA 402-R-92-004, Office of Radiation Programs, Washington, DC, July (revised).
- U.S. EPA (Environmental Protection Agency). 1993a. *Protocols for Radon and Radon Decay Product Measurements in Homes*. EPA-402-R-92-003, May 1993a.
- U.S. EPA (Environmental Protection Agency). 1993b. *Radon Reduction Techniques for Existing Detached Houses, Technical Guidance (third edition) for Active Soil Depressurization Systems*. EPA/625/R-93/011.
- U.S. EPA (Environmental Protection Agency). 1997. *Compendium of Methods for the Determination of Toxic Organic Compounds in Ambient Air, Second Edition, Compendium Method TO-17: Determination of Volatile Organic Compounds in Ambient Air Using Active Sampling Onto Sorbent Tubes*. EPA/625/R-96/010b. January.
- U.S. EPA (Environmental Protection Agency). 1999. *Compendium of Methods for the Determination of Toxic Organic Compounds in Ambient Air, Second Edition, Compendium Method TO-14Ab: Determination of Volatile Organic Compounds (VOCs) in Ambient Air Using Specially Prepared Canisters With Subsequent Analysis By Gas Chromatography*. EPA/625/R-96/010b. Available at <http://www.epa.gov/ttnamti1/files/ambient/airtox/to-14ar.pdf>.
- U.S. EPA (Environmental Protection Agency). 1999. *Compendium of Methods for the Determination of Toxic Organic Compounds in Ambient Air Second Edition Compendium Method TO-15 Determination Of Volatile Organic Compounds (VOCs) In Air Collected In Specially-Prepared Canisters And Analyzed By Gas Chromatography Mass Spectrometry (GC/MS)* EPA/625/R-96/010b. Available at <http://www.epa.gov/ttnamti1/files/ambient/airtox/to-15r.pdf>.

- U.S. EPA (Environmental Protection Agency). 2002a. *OSWER Draft Guidance for Evaluating the Vapor Intrusion to Indoor Air Pathway from Groundwater and Soils (Subsurface Vapor Intrusion Guidance)*. EPA530-D-02-004. Available at <http://www.epa.gov/correctiveaction/eis/vapor.htm>
- U.S. EPA (Environmental Protection Agency). 2002b. *Guidance on Environmental Data Verification and Validation*. EPA QA/G-8 EPA/240/R-02/004. November. Available at <http://www.epa.gov/quality/qs-docs/g8-final.pdf>.
- U.S. EPA (Environmental Protection Agency). 2003. *A Standardized EPA Protocol for Characterization of Indoor Air Quality in Large Office Buildings*. U.S. EPA Indoor Air Division and Atmospheric Research and Exposure Assessment Laboratory. Available at http://www.epa.gov/iaq/base/pdfs/2003_base_protocol.pdf.
- U.S. EPA (Environmental Protection Agency). 2005a. *DRAFT Standard Operating Procedure (SOP) for Installation of Sub-Slab Vapor Probes and Sampling Using EPA Method TO-15 to Support Vapor Intrusion Investigations*. Available at http://www.epa.gov/region8/r8risk/pdf/epa_sub-slabvapor.pdf.
- U.S. EPA (Environmental Protection Agency). 2005b. *DRAFT Assessment of Vapor Intrusion in Homes Near the Former Raymark Superfund Site - Recommendations for Testing at Other Sites*.
- U.S. EPA (Environmental Protection Agency). 2011. *Exposure Factors Handbook 2011 Edition (Final)*. EPA/600/R-09/052F. 2011. Office of Research and Development, Washington, DC.
- U.S. EPA (Environmental Protection Agency). 2012a. *Conceptual Model Scenarios for the Vapor Intrusion Pathway*. Office of Solid Waste and Emergency Response, Washington, DC. Available at <http://www.epa.gov/oswer/vaporintrusion/documents/vi-cms-v11final-2-24-2012.pdf>.
- U.S. EPA (Environmental Protection Agency). 2012b. *EPA On-line Tools for Site Assessment Calculation: Johnson and Ettinger Attenuation Factor*. U.S. EPA Ecosystems Research, Athens, GA. Available at http://www.epa.gov/athens/learn2model/part-two/onsite/jne_alpha.htm.
- U.S. EPA (Environmental Protection Agency). 2012c. *EPA's Vapor Intrusion Database: Evaluation and Characterization of Attenuation Factors for Chlorinated Volatile Organic Compounds and Residential Buildings*. EPA 530-R-10-002. Office of Solid Waste and Emergency Response, Washington, DC. March 16. Available at http://www.epa.gov/oswer/vaporintrusion/documents/OSWER_2010_Database_Report_03-16-2012_Final_witherratum_508.pdf.
- U.S. EPA (Environmental Protection Agency). 2012c. *Drinking Water Contaminants*. Available at <http://water.epa.gov/drink/contaminants/index.cfm>.
- University of Minnesota. 2008. *Re-Arch: The Initiative for Renewable Energy in Architecture*. Fact Sheet. University of Minnesota Initiative for Renewable Energy in Architecture (re-ARCH). Available at <http://www.research.umn.edu/factsheets/VentilationFactSheet.pdf>.
- Wang, F., and I.C. Ward. 2000. The development of a radon entry model for a house with a cellar. *Building and Environment* 35:615–631.
- Wertz, W., and T. Festa. 2007. The patchy fog model of vapor intrusion. Pp. 28–36 in *Proceedings of AWMA Conference on Vapor Intrusion: Learning from the Challenges*, Providence, RI, September 26–28. Pittsburgh, PA: Air and Waste Management Association.
- Whitmore, A., and R.L. Corsi. 1994. Measurement of gas-liquid mass transfer coefficients for volatile organic compounds in sewers. *Environmental Progress* May:114–123.
- Wickham, H. 2009. *ggplot2: elegant graphics for data analysis*. New York: Springer.

- Wilson, L.G., L.G. Everett, and S.J. Cullen (Eds.). 1995. *Handbook of Vadose Zone Characterization and Monitoring*. Boca Raton, FL: Lewis Publishers.
- Winberry, W. T. et al. 1990. *Compendium of Methods for the Determination of Air Pollutants in Indoor Air*. EPA/600/4-90/010. April.
- Wisbeck D., C. Sharpe C., A. Frizzell, C. Lutes, and N. Weinberg. 2006. *Using naturally occurring radon as a tracer for vapor intrusion: A case study*. ARCADIS, presented at the 2006 Society of Risk Analysis (SRA) Annual Meeting, Baltimore, MD.
- Zhao, Y., and C. Frey. 2006. Uncertainty for data with non-detects: air toxic emissions from combustion. *Human and Ecological Risk Assessment* 12:1171–1191.

Appendix A
Soil Boring Logs

Interior Soil Gas Port (SGP) Borings

SGP 8

0 – 2.5 ft below the concrete slab- sandy silt, brown, moist
2.5 – 3.5 ft- tan/brown, slightly moist sand (med-fine); large gravel toward 3.5
3.5 – 6 ft- brown/tan, dry, sand and gravel. Some large gravel

SGP 9

0 – 2.5 ft below the concrete slab- dark brown, clayey, silty sand
2.5 – 3.5 ft - dramatic color change to tan sand with little to no cohesion
3.5 – 4 ft ft - same as the previous type, but the gravel size increases with depth from pea-sized to stones approximately 1 – 1.5 in long. A few are as big as 2 – 4 in. At about 4 ft, we hit the gravel layer that hinders the augur, making hand-drilling impossible.

Outdoor Soil Gas Port (SGP) Borings

The following are from the outdoor boring logs taken by Randy Woodruff from August 30 through September 1 of 2010. The depths for SGPs 8 and 9 correspond roughly to depths 5 – 11 ft and 5 – 9 ft respectively. For brevity, I have included only the logs for depths between 5 and 11 ft.

SGP 2

1.3 – 6.0 ft- Brown – Dk Brown, silty sandy clay, dry, stiff-firm, friable: sl. Plastic @ 3 ft; decreasing hardness with depth.
6.0 – 6.5 ft- Brown, silty sand with some clays, sl. moist, sl. plastic, cohesive
6.5 – 7.0 ft- Dk brown-grey, clayey sand with trace gravels, sl plastic, sl moist
7.0 – 11.0- Lt grey – Lt brown, sands and gravels, fine – coarse, loose – sl cohesive, sl moist; oxidation staining from 8.25 – 8.75 ft; slightly clayey from 9.0 – 9.5 ft.

SGP 3

3.0 – 7.0- Dk brown, silty clay, dry, sl plastic, sl moist at 6.5 ft
7.0 – 12.5 ft- Lt brown, sands with some clay, sl moist, sl plastic/cohesive; oxidation staining at 10.0 ft. Large gravels at 10.5 – 12.0 ft.

SGP 4

1.0 – 6.75 ft- Dk brown, sandy clay, moist, medium stiff; dry at 4.0 ft, hard
6.75 – 14.0 ft- Lt brown, sands and gravels with some clays, sl cohesive – loose, sl moist.

SGP 5

4.0 – 6.25 ft- brown, silty sandy clay, firm – hard, dry, sl plastic
6.25 – 8.0 ft- Lt brown, fine – med sands, sl moist, sl cohesive – loose
8.0 – 12.0 ft- Lt brown, sands and gravels with some clay, sl moist, fine – coarse, loose – sl cohesive.

SGP 7

1.25 – 6.75- Brown, silty sandy clay, dry, sl plastic – friable, trace-some gravels; ash and wood debris at 2.0 ft, stiff; dec gravel content with depth.
6.75 – 15.5 ft- Lt brown, sands and gravels, with some clay, non-plastic, sl cohesive, sl moist; fine – coarse sands; inc gravel size at 11.0 ft. Oxidation staining at 10.0 ft.

It looks like the dominant material for the first two feet or so beneath the slab is a dark brown silty sandy clay, dry to moist in some areas.



Well Construction Log (Unconsolidated)

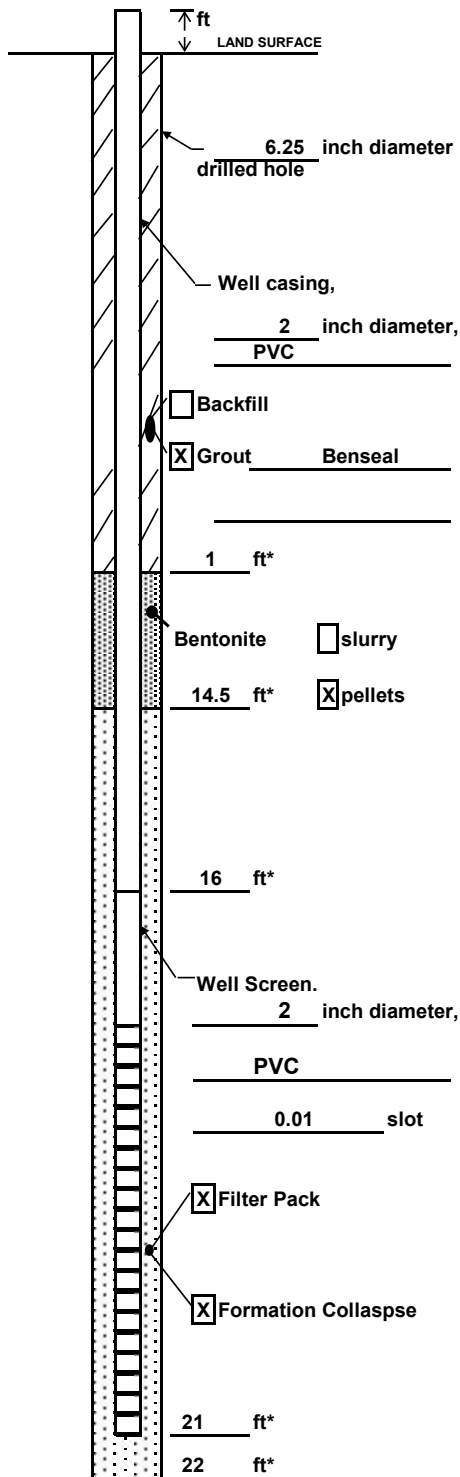

Project Name and No. TO-97

Well MW-1A Town/City Indianapolis, Indiana

County Marion State IN

Permit No. NA

Land-Surface Elevation and Datum:
 _____ feet Surveyed
 Estimated

Installation Date(s) 29-Apr-10

Drilling Method Geoprobe 6600 - Hollow Stem Auger

Drilling Contractor WDC

Drilling Fluid NA

Development Technique(s) and Date(s)

Surge Block and Pumping 4/30/2010

Fluid Loss During Drilling NA gallons

Water Removed During Development 80 gallons

Static Depth to Water 16 feet below M.P.**

Pumping Depth to Water _____ feet below M.P.**

Pumping Duration _____ hours

Yield _____ gpm Date _____

Specific Capacity _____ gpm/ft

Well Purpose Monitoring

Remarks _____

* Depth Below Land Surface

**Measuring Point is Top of Well Casing Unless Otherwise Noted.

Prepared by _____



Well Construction Log (Unconsolidated)

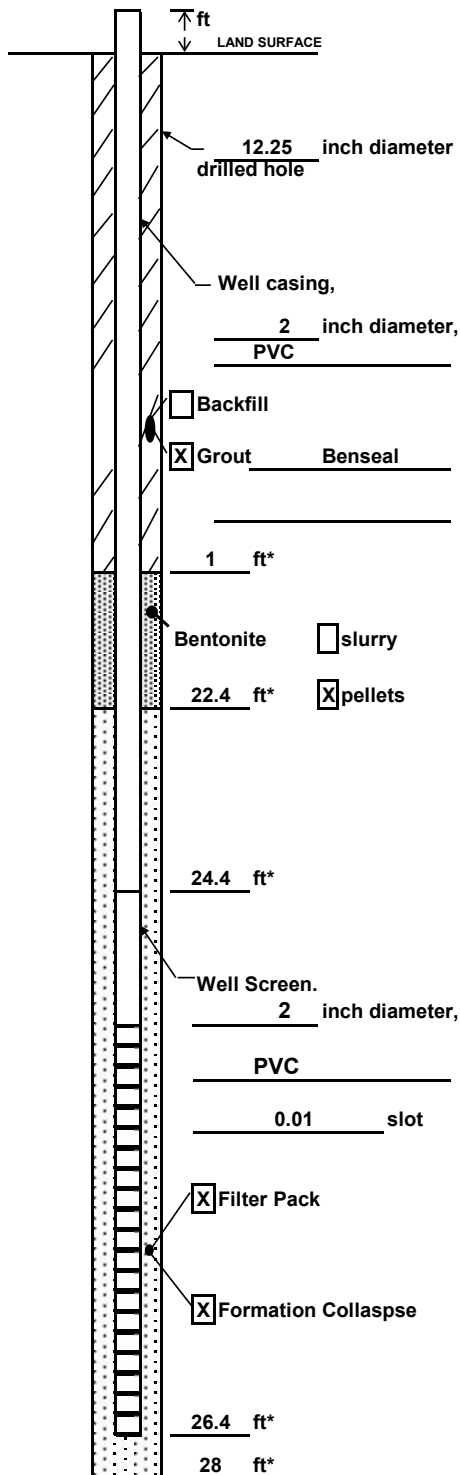

Project Name and No. TO-97

Well MW-1B Town/City Indianapolis, Indiana

County Marion State IN

Permit No. NA

Land-Surface Elevation and Datum:
 _____ feet Surveyed
 Estimated

Installation Date(s) 29-Apr-10

Drilling Method Geoprobe 6600 - Hollow Stem Auger

Drilling Contractor WDC

Drilling Fluid NA

Development Technique(s) and Date(s)

Surge Block and Pumping 4/30/2010

Fluid Loss During Drilling NA gallons

Water Removed During Development 80 gallons

Static Depth to Water 16 feet below M.P.**

Pumping Depth to Water _____ feet below M.P.**

Pumping Duration _____ hours

Yield _____ gpm Date _____

Specific Capacity _____ gpm/ft

Well Purpose Monitoring

Remarks _____

* Depth Below Land Surface

**Measuring Point is Top of Well Casing Unless Otherwise Noted.

Prepared by _____

SOIL GAS PORT CONSTRUCTION DIAGRAM

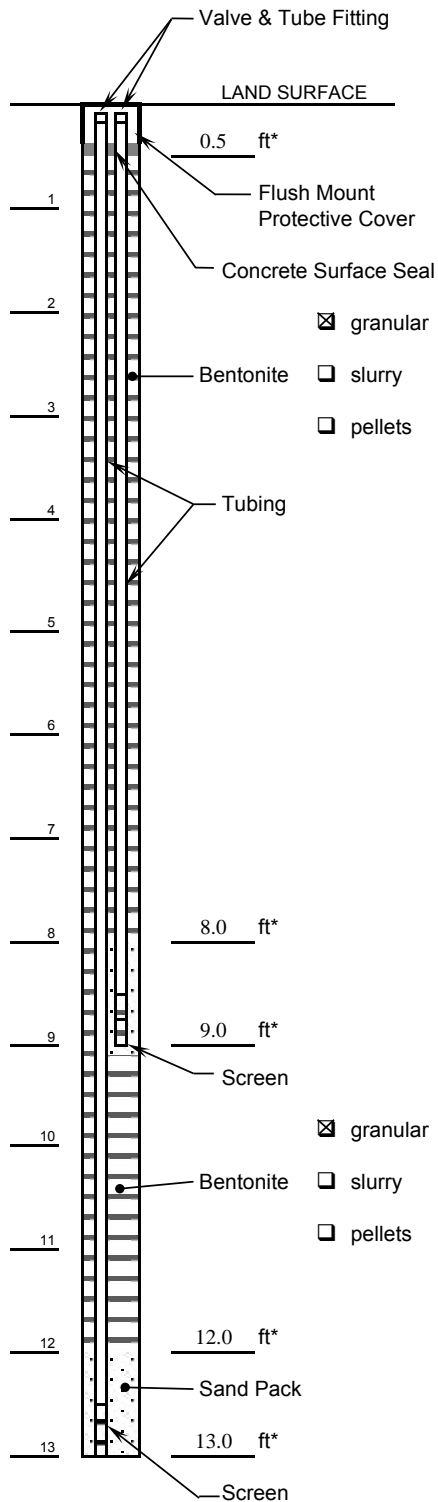

Project: TO-97 Port: SGP-1 (A&B)

City: Indianapolis,

County: Marion State: IN

GPS Coordinates:

Latitude: NA

Longitude: NA

Land-Surface Elevation and Datum:

NA feet Surveyed
 Estimated

Installation Date: 4/29/2010

Weather Conditions at Installation: Sunny, Warm

Drilling Contractor: WDC

Driller: Ron

Drilling Method: Geobrobe 6600 Maro-Core

Screen:

Construction: Stainless Steel Mesh

Length: 6 - inches

Tubing:

Construction: Teflon

Diameter: 1/4 - Inch OD

End Valve:

Type/Construction: _____

End Connection: SS Swagelok Tube Fitting

Volume of Air in Tubing/Screen: mLs

Volume of Air in Sandpack: mLs

Volume of Air Purged at Installation: mLs

Remarks: _____

Prepared by: RU

* Depth Below Land Surface

SOIL GAS PORT CONSTRUCTION DIAGRAM

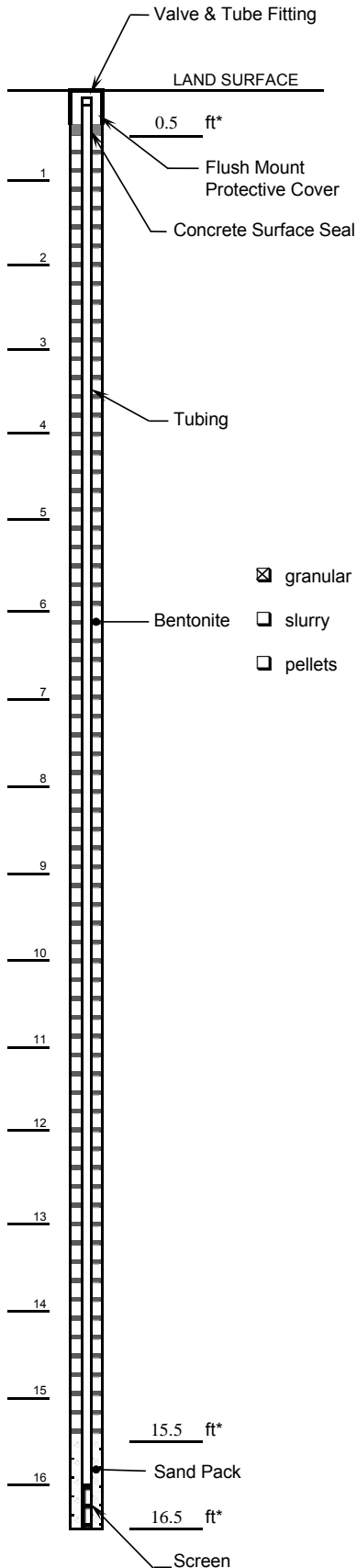

Project: TO-97 Port: SGP-1C

City: Indianapolis

County: Marion

State: IN

GPS Coordinates:

Latitude: NA

Longitude: NA

Land-Surface Elevation and Datum:

NA feet Surveyed
 Estimated

Installation Date: 4/29/2010

Weather Conditions at Installation: Sunny, warm

Drilling Contractor: WDC

Driller: Andy

Drilling Method: Geobrobe 6600 Maro-Core

Screen:

Construction: Stainless Steel Mesh

Length: 6 - inches

Tubing:

Construction: Teflon

Diameter: 1/4 - Inch OD

End Valve:

Type/Construction: _____

End Connection: SS Swagelok Tube Fitting

Volume of Air in Tubing/Screen: mLS

Volume of Air in Sandpack: mLS

Volume of Air Purged at Installation: mLS

Remarks: _____

Prepared by: RU

* Depth Below Land Surface



ROCK CORING / SAMPLING / WELL CONSTRUCTION LOG

Boring/Well TEST HOLE Project/No. _____ Page 1 of 1
 Site Location TEST HOUSE Drilling Date/Time Started 8:30-10 0912 Drilling Date/Time Completed _____
 Drilling Contractor EARTH EXPLORATION Driller/License# _____
 Drilling Fluid Used _____ Drilling Method GEOPROBE
 Length and Diameter of Coring Device _____ Sampling Interval _____ feet
 Land-Surface Elev. _____ feet Surveyed Estimated Datum _____
 Total Depth Drilled 16.5' Feet Hole Diameter _____ Coring Device _____
 Prepared By R. Woodruff Hammer Weight _____ Hammer Drop _____ ins.
 Boring Termination Depth 16.5' Water _____ GPS Coordinates _____

Sampling Data:

Depth	Grab/Composite	Time	QA/QC Samples	Laboratory Analysis

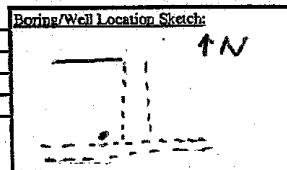

Soil Characterization:

Sample/Core Depth (Feet bls)	Core Recovery (%)	OVM Reading (ppm)	Blow Counts per 6 inches	USCS Description/Depth		Sample/Core Description
				From	To	
0	80	—	—	0.0 - 0.25'		TOPSOIL, ORGANICS, GR. FINE, DEBRIS
2	80	—	—	0.25 - 3.2'		BROWN, SANDY CLAY, TR. GRANULES, DRY, MEDIUM STIFF, DAMP
4	75	—	—	3.2 - 5.0'		DK. BROWN, CLAY SANDS, DRY, FRESH
6	75	—	—	5.0 - 5.5'		BROWN, CLAY SANDS, MEDIUM STIFF, SL. MOIST, SL.
8	45	—	—			MASTIC
10	45	—	—	5.5 - 16.5'		BROWN-LT. BROWN, SAND w/ SOME CLAY, GRANULES
12	100	45	—			FINE-COARSE, MOIST; WET @ 8.25', MOIST
14	100	45	—			CLAY FROM 10'-10.75'; OXIDATION STAINING
16	100	—	—			FROM 12.75-15'; MEDIUM SAND @ 15.25'

Well Construction Details:

Surface Protection	Casing	Seal	Screen	Filter Pack
Type _____	Diameter _____	Type _____	Type _____	Material _____
Total Depth _____	Length _____	Top Depth _____	Diameter _____	Top Depth _____
	Material _____	Bottom Depth _____	Slot Size _____	Bottom Depth _____
			Top Depth _____	
			Bottom Depth _____	

Boring Log: GP-7

Project Name: Mapleton - Fall Creek Date Started: 6-21-05 Logger: TY
 Project Number: IN000763.0001.00003 Date Completed: _____ Editor: TY

Depth (feet)	Blows (/6 in.)	Recovery (inches)	Sample	PID (PPM)	Graphic Log	Soil Class.	Description
0	3788	20		0.0		FILL	Topsail
	34713	20		0.0		vc	Brown (10YR 4/3) silty sandy clay, slightly plastic, slightly cohesive, non-sticky, slightly moist, trace gravel
	8545	3		0.0			
	4345	12		0.0			
	22510	12		0.0		SC	Dark reddish brown (5YR 3/4) clayey sand, nonplastic, slightly cohesive, non-sticky, moist
	681524	14		0.0			
	1391011	12		0.0		GP-SP	Very pale brown (10YR 8/4) medium to coarse sand with trace gravel, dry, poorly graded, sub-rounded
	12111417	3		0.0			
	58812	12		0.0		gp-sp	Dark yellowish brown (10YR 4/6) medium to coarse sand and gravel, slightly wet, poorly graded, sub-rounded; wet @ 16.0'
	79812	20		0.0			
	128610	20		0.0		GP	Dark yellowish brown (10YR 4/6) gravel, wet, poorly graded, sub-rounded
	77917	20		0.0		gp-sp	Dark yellowish brown (10YR 4/6) medium to coarse sand and gravel, dry, poorly graded, sub-rounded
25							
30							

Composite Sample to Lab Grab Sample to Lab Sample Not Analyzed Page 1 of 1

Drilling Co.: Earth Exploration Sampling Method: Split Spoon
 Driller: B. Scott Phillips Sampling Interval: 2.0'
 Drilling Method: HSA Water Level Start: 16.0'
 Drilling Fluid: None Water Level Finish: _____

ARCADIS

Well Construction Log:

GP-7

Project Name: <u>Mapleton - Fall Creek</u>	Date: <u>6-21-05</u>	Logger: <u>TY</u>
Project Number: <u>IN000763.0001.00003</u>	Editor: <u>TY</u>	

Depth (feet)	Graphic Log	Well Construction Diagram	Well Construction Details
0			<p>PROTECTIVE COVER TYPE: Stick-up</p>
5			<p>SURFACE SEAL Type: <u>Bentonite</u> Total Depth: <u>11.0'</u></p>
10			<p>ANNULAR SEAL Type: _____ Top Depth: _____ Bottom Depth: _____</p>
15			<p>CASING Inside Diameter: <u>1.0"</u> Length: <u>13.0'</u> Material: <u>PVC</u></p>
20			<p>SEAL Type: <u>Bentonite</u> Top Depth: <u>0.0'</u> Bottom Depth: <u>11.0'</u></p>
25			<p>SCREEN Type <u>PVC</u> Inside Diameter: <u>1.0"</u> Slot Size: <u>0.010"</u> Top Depth: <u>13.0'</u> Bottom Depth: <u>23.0'</u></p>
30			<p>FILTER PACK Material: <u>Sand</u> Top Depth: <u>11.0'</u> Bottom Depth: <u>23.0'</u></p>

Drilling Co.: <u>Earth Exploration</u>	Filter Placement Method: <u>Gravity Pour</u>
Driller: <u>B. Scott Phillips</u>	Seal Placement Method: <u>Gravity Pour</u>
Drilling Method: <u>HSA</u>	Total Depth (TOC): <u>23.0'</u>
Drilling Fluid: <u>None</u>	Water Level Finish: _____

Project Name: Mapleton - Fall Creek Date Started: 6-21-05 Logger: TY
 Project Number: IN000763.0001.00003 Date Completed: _____ Editor: TY

Depth (feet)	Blows (/6 in.)	Recovery (inches)	Sample	PID (PPM)	Graphic Log	Soil Class.	Description
0	5 5 1 1	12	▀	0.0		FILL	Topsail
	1 1 1 2	3	▀	0.0		vc	Brown (10YR 4/3) silty sandy clay, plastic, cohesive, sticky, moist, trace gravel
	8 1 7 8 8	3	▀	0.0			
5	7 5 3 8	3	▀	0.0			
	1 1 8 1 2	3	▀	0.0			
10	8 1 1 1 8 2 8	12	▀	0.0		gp-sp	Very pale brown (10YR 8/4) medium to coarse sand and gravel, dry, poorly graded, sub-rounded
	1 2 1 1 1 2 1 7	12	▀	0.0			
15	1 5 1 3 1 6 2 7	12	▀	0.0			
	3 4 3 0 3 6 2 8	3	▀	0.0			
20	1 4 1 0 1 4 2 3	20	▀	0.0		gp-sp	Dark yellowish brown (10YR 4/6) medium to coarse sand and gravel, wet, poorly graded, sub-rounded
	8 8 8 1 8	20	▀	0.0			
25	1 4 1 3 1 9 3 1	20	▀	0.0			
	1 4 1 5 2 1 2 8	20	▀	0.0			
30							

Composite Sample to Lab
 Grab Sample to Lab
 Sample Not Analyzed
 Page 1 of 1

Drilling Co.: Earth Exploration Sampling Method: Split Spoon
 Driller: B. Scott Phillips Sampling Interval: 2.0'
 Drilling Method: HSA Water Level Start: 18.0'
 Drilling Fluid: None Water Level Finish: _____

ARCADIS

Well Construction Log:

GP-8

Project Name: Mapleton - Fall Creek Date: 6-21-05 Logger: TY
Project Number: IN000763.0001.00003 Editor: TY

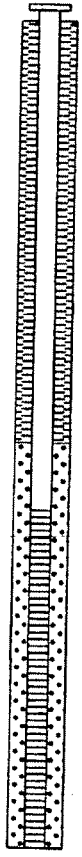
Depth (feet)	Graphic Log	Well Construction Diagram	Well Construction Details
0 5 10 15 20 25 30			<p>PROTECTIVE COVER TYPE: <u>Stick-up</u></p> <p>SURFACE SEAL Type: <u>Bentonite</u> Total Depth: <u>13.0'</u></p> <p>ANNULAR SEAL Type: _____ Top Depth: _____ Bottom Depth: _____</p> <p>CASING Inside Diameter: <u>1.0"</u> Length: <u>15.0'</u> Material: <u>PVC</u></p> <p>SEAL Type: <u>Bentonite</u> Top Depth: <u>0.0'</u> Bottom Depth: <u>13.0'</u></p> <p>SCREEN Type: <u>PVC</u> Inside Diameter: <u>1.0"</u> Slot Size: <u>0.010"</u> Top Depth: <u>15.0'</u> Bottom Depth: <u>25.0'</u></p> <p>FILTER PACK Material: <u>Sand</u> Top Depth: <u>13.0'</u> Bottom Depth: <u>25.0'</u></p>

Drilling Co.: Earth Exploration Filter Placement Method: Gravity Pour
Driller: B. Scott Phillips Seal Placement Method: Gravity Pour
Drilling Method: HSA Total Depth (TOC): 25.0'
Drilling Fluid: None Water Level Finish: _____

Boring Log: GP-9

Project Name: Mapleton - Fall Creek Date Started: 6-22-05 Logger: TY
 Project Number: IN000763.0001.00003 Date Completed: _____ Editor: TY

Depth (feet)	Blows (/6 in.)	Recovery (inches)	Sample	PID (PPM)	Graphic Log	Soil Class.	Description
0	-- 3 1	12		0.0		fill	Concrete
	1 1 4 3	3		0.0		vc	Brown (10 YR 4/3) silty sandy clay, nonplastic, non-cohesive, non-sticky, dry, friable, trace gravel; increased moisture at 4.0'
	1 2 2 3	12		0.0			
5	5 6 5 6	20		0.0			
	4 8 4 4	12		0.0		sp	Dark yellowish brown (10YR 4/6) fine to medium sand, poorly sorted, sub-rounded, moist
10	2 3 1 2 8	12		0.0		gp-sp	Dark yellowish brown (10YR 4/6) medium to coarse sand and gravel, dry, poorly sorted, sub-rounded
	1 6 1 8 8 1 4	12		0.0			
15	1 7 3 1 4 1 2 1	3		0.0			
	2 2 3 6 8 8	12		18.2			
	1 2 1 5 7 1 1	20		7.9		sp	Dark yellowish brown (10YR 4/6) fine to medium sand, poorly sorted, sub-rounded, wet
20	1 4 2 3 6 8	20		0.4		gp-sp	Dark yellowish brown medium to coarse sand and gravel, wet, poorly sorted, sub-rounded
	1 0 1 4 1 3 1 5	20		0.0			
25							
30							

Composite Sample to Lab Grab Sample to Lab Sample Not Analyzed Page 1 of 1

Drilling Co.: Earth Exploration Sampling Method: Split Spoon
 Driller: B. Scott Phillips Sampling Interval: 2.0'
 Drilling Method: HSA Water Level Start: 17.0'
 Drilling Fluid: None Water Level Finish: _____

ARCADIS

Well Construction Log:

GP-9

Project Name: Mapleton - Fall Creek Date: 6-22-05 Logger: TY
Project Number: IN000763.0001.00003 Editor: TY

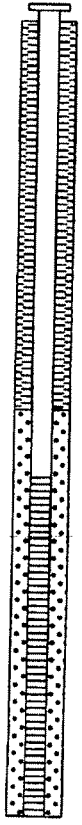
Depth (feet)	Graphic Log	Well Construction Diagram	Well Construction Details
0 5 10 15 20 25 30			<p>PROTECTIVE COVER TYPE: <u>Stick-up</u></p> <p>SURFACE SEAL Type: <u>Bentonite</u> Total Depth: <u>12.0'</u></p> <p>ANNULAR SEAL Type: _____ Top Depth: _____ Bottom Depth: _____</p> <p>CASING Inside Diameter: <u>1.0"</u> Length: <u>14.0'</u> Material: <u>PVC</u></p> <p>SEAL Type: <u>Bentonite</u> Top Depth: <u>0.0'</u> Bottom Depth: <u>12.0'</u></p> <p>SCREEN Type: <u>PVC</u> Inside Diameter: <u>1.0"</u> Slot Size: <u>0.010"</u> Top Depth: <u>14.0'</u> Bottom Depth: <u>24.0'</u></p> <p>FILTER PACK Material: <u>Sand</u> Top Depth: <u>12.0'</u> Bottom Depth: <u>24.0'</u></p>

Drilling Co.: Earth Exploration Filter Placement Method: Gravity Pour
Driller: B. Scott Phillips Seal Placement Method: Gravity Pour
Drilling Method: HSA Total Depth (TOC): 24.0'
Drilling Fluid: None Water Level Finish: _____

Boring Log: GP-10

Project Name: Mapleton - Fall Creek Date Started: 6-22-05 Logger: TY
 Project Number: IN000783.0001.00003 Date Completed: _____ Editor: TY

Depth (feet)	Blows (/8 in.)	Recovery (inches)	Sample	PID (PPM)	Graphic Log	Soil Class.	Description
0	-- 3 1	12		0.0		fill	Concrete
	2 5 3 3	12		0.0		vc	Brown (10YR 4/3) silty sandy clay, slightly plastic, slightly cohesive, non-sticky, slightly moist, trace gravel
	4 3 3 8	3		0.0			
5	5 3 3 4	12		0.0			
	4 7 3 4	12		0.0			
						SP	Very pale brown (10YR 8/4) fine to medium sand, dry, poorly sorted, sub-rounded
10	11 15 15 19	12		0.0			
	17 19 15 12	12		0.0		gp-sp	Very pale brown (10YR 8/4) medium to coarse sand and gravel, dry, poorly graded, sub-rounded
	11 19 24 18	20		0.0			
15	18 18 4 5	12		0.0			
	5 7 11 12	20		0.0		gp-sp	Dark yellowish brown (10YR 4/6) medium to coarse sand and gravel, wet, poorly sorted, sub-rounded
20	12 13 7 7	12		0.0			
	7 8 10 14	20		0.0			
25							
30							

Composite Sample to Lab
 Grab Sample to Lab
 Sample Not Analyzed
 Page 1 of 1

Drilling Co.: Earth Exploration Sampling Method: HSA
 Driller: B. Scott Phillips Sampling Interval: 2.0'
 Drilling Method: HSA Water Level Start: 17.0'
 Drilling Fluid: None Water Level Finish: _____

BORING LOG

BORING NO: 6P-1
PROJECT NO: IN000620.0001

PROJECT NAME: Fall Creek & Central CLIENT: Mapleton-Fall Creek
PROJECT LOCATION: Indianapolis, IN DRILLING CONTRACTOR: Paramount Environmental Services
DRILLING MTHD: Geoprobe SAMPLE MTHD: Sleeve
TIME STARTED: 08:45 TIME FINISHED: 09:30 DATE: 8/23/00 GEOLOGIST: S. Fisher

DEPTH (FT)	SPT BLOWS PER 6"	REC (%)	PID (ppm)	LITHOLOGY	SURFACE ELEVATION: NA		REMARKS
					LITHOLOGIC DESCRIPTION		
0.0	1	100	0	[Pattern]	GRASS, DARK BROWN FILL, MOIST		Sample collected from 10 - 12 feet interval
	2	75	0	[Pattern]	REDDISH BROWN SANDY CLAY LOAM, MOIST, FRIABLE, COHESIVE		
5.0	3	100	0	[Pattern]	REDDISH BROWN SANDY LOAM, MOIST, FRIABLE		
	4	75	0	[Pattern]			
	5	100	0	[Pattern]			
10.0	6	100	0	[Pattern]	LIGHT BROWN SAND AND GRAVEL, MOIST, FRIABLE, LOOSE SOME GRAY STAINING AT 11 FEET		
	7	100	0	[Pattern]			
15.0	8	100	0	[Pattern]	LIGHT BROWN COARSE SAND AND GRAVEL, MOIST, LOOSE		
20.0							
25.0							
30.0							

BOTTOM OF TEST BORING: 16.00'

SPT - STANDARD PENETRATION TEST
REC - SAMPLE RECOVERY
ND - NON-DETECTABLE
FID - FLAME IONIZATION DETECTOR
PID - PHOTO-IONIZATION DETECTOR

BORING LOG

BORING NO: 6P-2

PROJECT NO: IN000620.0001

PROJECT NAME: Fall Creek & Central

CLIENT: Mapleton-Fall Creek

PROJECT LOCATION: Indianapolis, IN

DRILLING CONTRACTOR: Paramount Environmental Services

DRILLING MTHD: Geoprobe

SAMPLE MTHD: Sieve

TIME STARTED: 09:30

TIME FINISHED: 10:45

DATE: 8/23/00

GEOLOGIST: B. Fleher

DEPTH (FT)	SPT BLDG PER 5"	REC (%)	PID (ppm)	LITHOLOGIC DESCRIPTION	REMARKS
0.0				SURFACE ELEVATION: NA	
1		100	0	GRASS FILL	
2		100	0	BROWN SANDY LOAM, MOIST, FRIABLE	
3		100	0	REDDISH BROWN SILT LOAM, MOIST, COHESIVE, FRIABLE	
4		100	0	LIGHT BROWN SAND, LOOSE, NON-COHESIVE, FRIABLE	
5		100	0	ORANGE BROWN SAND, LOOSE, MOIST, NON-COHESIVE, FRIABLE	
6		100	0		
7		75	0	LIGHT BROWN SAND AND GRAVEL, DRY, LOOSE, NON-COHESIVE	
8		75	0		
15.0					Sample collected From 12 - 14 Feet Interval
20.0					
25.0					
30.0					

BOTTOM OF TEST BORING: 16.00'

- SPT - STANDARD PENETRATION TEST
- REC - SAMPLE RECOVERY
- ND - NON-DETECTABLE
- FID - FLAME IONIZATION DETECTOR
- PID - PHOTO-IONIZATION DETECTOR

BORING LOG

BORING NO: 6P-3

PROJECT NO: IN000620.0001

PROJECT NAME: Fall Creek & Central

CLIENT: Mapleton-Fall Creek

PROJECT LOCATION: Indianspolis, IN

DRILLING CONTRACTOR: Paramount Environmental Services

DRILLING MTHD: Gasprobe

SAMPLE MTHD: Sieve

TIME STARTED: 10:45

TIME FINISHED: 11:20

DATE: 8/23/00

GEOLOGIST: B. Fisher

DEPTH (FT)	SPT BLows PER 6"	REC (%)	PID (ppm)	FID	SURFACE ELEVATION: NA	REMARKS
					LITHOLOGIC DESCRIPTION	
0.0						Sample collected from 12 - 14 feet interval
1		75	0		GRASS, DARK BROWN SILTY CLAY LOAM, MOIST, COHESIVE, FRIABLE	
2		75	0			
5.0		100	0		LIGHT BROWN FINE SANDY LOAM, MOIST, COHESIVE, FRIABLE	
4		100	0			
5		90	0		LIGHT BROWN COARSE SAND AND GRAVEL, MOIST, FRIABLE, LOOSE SOME ORANGE MOTTLING DARKER BROWN AT 13 FEET	
10.0		90	0			
7		100	0			
15.0		100	0			
20.0						
25.0						
30.0						

BOTTOM OF TEST BORING: 16.00'

- SPT = STANDARD PENETRATION TEST
- REC = SAMPLE RECOVERY
- ND = NON-DETECTABLE
- FID = FLAME IONIZATION DETECTOR
- PID = PHOTO-IONIZATION DETECTOR

BORING LOG

BORING NO: BP-1

PROJECT NO: IN000620.0001

PROJECT NAME: Fall Creek & Central

CLIENT: Mapleton-Fall Creek

PROJECT LOCATION: Indianapolis, IN

DRILLING CONTRACTOR: Perseus Environmental Services

DRILLING MTHD: Geoprobe

SAMPLE MTHD: Sieve

TIME STARTED: 11:30

TIME FINISHED: 12:15

DATE: 8/23/00

GEOLOGIST: B. Fisher

DEPTH (FT)	SPT	BPT BLOWS PER 6"	REC (%)	PID (ppm)	FID (ppm)	SURFACE ELEVATION: NA	REMARKS
						LITHOLOGIC DESCRIPTION	
0.0	1		75	0		GRASS FILL (COAL, BRICK, VERY LITTLE SOIL), MOIST, FRIABLE	
	2		75	0			
5.0	3		100	0		BROWN FINE SANDY LOAM, MOIST, FRIABLE, COHESIVE MOTTLES AT 7.5 FEET	
	4		100	0			
	5		50	0			
10.0	6		50	0		REDDISH BROWN/ LIGHT BROWN COARSE SAND AND GRAVEL, MOIST, FRIABLE	
	7		75	0			
15.0	8		75	0		GRAY BROWN SAND AND GRAVEL, DRY, FRIABLE, LOOSE	Sample collected from 14 - 15 feet interval
20.0							
25.0							
30.0							

BOTTOM OF TEST BORING: 16.00'

- SPT = STANDARD PENETRATION TEST
- REC = SAMPLE RECOVERY
- ND = NON-DETECTABLE
- FID = FLAME IONIZATION DETECTOR
- PID = PHOTO-IONIZATION DETECTOR

BORING LOG

BORING NO: GP-5

PROJECT NO: IN000620.0001

PROJECT NAME: Fall Creek & Central

CLIENT: Mapleton-Fall Creek

PROJECT LOCATION: Indianapolis, IN

DRILLING CONTRACTOR: Paramount Environmental Services

DRILLING MTHD: Geoprobe

SAMPLE MTHD: Sleeve

TIME STARTED: 12:15

TIME FINISHED: 13:00

DATE: 8/23/00

GEOLOGIST: B. Fleher

DEPTH (FT)	BPT BLOWS PER 5'	REC (%)	PID (ppm)	METHOD	SURFACE ELEVATION: NA	REMARKS
					LITHOLOGIC DESCRIPTION	
0.0					CONCRETE/ FILL	
1		50	0		CONC/FILL	
2		50	0			Sample collected from 2 - 4 Feet Interval
3		75	0			
4		75	0		GRAY SANDY LOAM, MOIST, COHESIVE, FRIABLE	
5		100	0		REDDISH BROWN SAND AND GRAVEL, MOTTLING, MOIST, LODGE, FRIABLE	
6		100	0			
7		75	0			
8		75	0			Sample collected from 14 - 16 Feet Interval
15.0						
20.0						
25.0						
30.0						

BOTTOM OF TEST BORING: 16.00'

- BPT - STANDARD PENETRATION TEST
- REC - SAMPLE RECOVERY
- ND - NON-DETECTABLE
- FID - FLAME IONIZATION DETECTOR
- PID - PHOTO-IONIZATION DETECTOR

BORING LOG

BORING NO: 6P-6

PROJECT NO: IN000620.0001

PROJECT NAME: Fall Creek & Central

CLIENT: Mapleton-Fall Creek

PROJECT LOCATION: Indianapolis, IN

DRILLING CONTRACTOR: Paramount Environmental Services

DRILLING MTHD: Geoprobe

SAMPLE MTHD: Slieve

TIME STARTED: 12:00

TIME FINISHED: 13:35

DATE: 8/23/00

GEOLOGIST: B. Fisher

DEPTH (FT)	SPT BLOWS PER 5"	REC (%)	PID (ppm)	REMARKS	LITHOLOGIC DESCRIPTION	SURFACE ELEVATION: NA
0.0					CONCRETE FILL	
1		50	0		BLACK SILT LOAM (FILL), MOIST, FRIABLE	
2		50	0		DARK BROWN SILT LOAM, MOIST, FRIABLE, COHESIVE APPROXIMATELY 2 INCHES COAL AT 6 FEET	
5.0		100	0			
4		100	0		LIGHT BROWN FINE SANDY LOAM, ORANGE MOTTLES, MOIST, FRIABLE	
5		100	0			
10.0		100	0		LIGHT BROWN SAND WITH TRACE GRAVEL, ORANGE AND GRAY MOTTLING, MOIST, LOOSE, FRIABLE	
7		100	0			
15.0		100	0		LIGHT BROWN SANDY CLAY, MOIST, PLASTIC, FRIABLE, COHESIVE	
8		100	0		LIGHT BROWN COARSE SAND AND GRAVEL, MOIST, FRIABLE, LOOSE	
20.0						
25.0						
30.0						

Sample collected from 10 - 12 feet interval

BOTTOM OF TEST BORING: 16.00'

- SPT - STANDARD PENETRATION TEST
- REC - SAMPLE RECOVERY
- ND - NON-DETECTABLE
- FID - FLAME IONIZATION DETECTOR
- PID - PHOTO-IONIZATION DETECTOR

Appendix B

Temporary vs. Permanent Subslab Port Study

Initial Draft

Interim Report for Subtask 2E

**Fluctuation of Indoor Radon and
VOC Concentrations Due to
Seasonal Variations: Temporary vs. Permanent Subslab Port Study**

**Draft
Category III
U.S. EPA Contract Number EP-C-05-060
Project No. RN007160.0002
Task Order (TO) 97**

Prepared for:

RTI International
Research Triangle Park, North Carolina

U.S. Environmental Protection Agency
National Engineering Research Laboratory
Las Vegas, Nevada

Prepared By:

ARCADIS U.S., Inc.
4915 Prospectus Drive
Suite F
Durham, NC 27713

December 2010

Title and Approval Sheet

Initial Draft
Interim Report for Subtask 2E
Fluctuation of Indoor Radon and VOC Concentrations
Due to Seasonal Variations (QA Category III)

Brian Schumacher Date
EPA Task Order Project Officer

Robert Truesdale, RTI Task Order Manager Date

Chris Lutes Date
ARCADIS Task Order Manager

Laura Beach Nessley Date
ARCADIS Quality Assurance Officer

Concurrence

Ed Heithmar, ECB QA Coordinator Date

George M. Brilis Date
EPA ESD QA Manager

Table of Contents

Title and Approval Sheet	i
List of Tables	iii
List of Figures	iii
List of Appendices	iii
1. Project Background, Definition, and Objectives	4
1.1 Sub-Slab Port Installation and Use	4
1.2 Objectives	5
2. Methods	6
2.1 Probe Installation and Leak Checks	9
2.2 Sub-Slab Sampling Using Summa Type Canisters for VOCs	9
3. Results	12
3.1 Seal Integrity	12
3.2 VOC Sampling Results	13
3.3 Radon Results	16
3.4 Study Limitations	16
4. Conclusions	18
5. References	18

List of Tables

Table 1. Test Matrix: Sample Number, Frequency and Location	7
Table 2. Test Matrix: Analytical Methods, Analytes, Laboratory and Turnaround Times	8
Table 3. Summa Canister Sampling Times and Pressures	11
Table 4. Leak Test Results for Temporary Probes	13
Table 5. Radon Data Comparing Temporary and Permanent Probes	18

List of Figures

Figure 1. Interiors of test buildings, showing soil gas points (SGP) and paired single-depth temporary and permanent sub-slab ports (SSP).	10
Figure 2. PCE concentrations in soil gas from temporary and permanent subslab probes.	14
Figure 3. Chloroform concentrations in soil gas from temporary and permanent subslab probes.	15
Figure 4. TCE concentration in soil gas from temporary and permanent subslab probes.	16

List of Appendices

Appendix A: Photographs of Ports after Sampling	
---	--

1. Project Background, Definition, and Objectives

This interim report presents the implementation and results of Subtask 2E, comparing the performance of permanent and temporary sub-slab sampling ports for measuring volatile organic compounds (VOCs) in soil gas beneath a basement building slab. This work is described in more detail in Addendum 1 to “*Fluctuation of Indoor Radon and VOC Concentrations Due to Seasonal Variations; Quality Assurance Project Plan*” (ARCADIS, November, 2010) [QAPP Addendum 1].

1.1 Sub-Slab Port Installation and Use

An introduction to vapor intrusion (VI) and the role of sub-slab sampling in investigating VI is provided in the QAPP. In the original TO-97 study, sub-slab soil gas sampling ports were installed in the basement floor of the test building at 422 East 28th St., Indianapolis, IN. These ports are considered “permanent” and were installed in accordance with an SOP provided in the QAPP. Only the single-depth permanent sub-slab ports installed beneath the basement floor slab were used in this study, not the multi-depth soil gas points.

To ensure comparability in this study, the methods used to install the TO-97 permanent sub-slab ports were compared with procedures for permanent ports published in two guidance documents:

- *Vapor Intrusion Guidance*, New Jersey Department of Environmental Protection (NJDEP), dated October 2005; at <http://www.nj.gov/dep/srp/guidance/vaporintrusion/vig.htm>) [VIG]
- Response Engineering and Analytical Contract SOP 2082: *Construction and Installation of Permanent Sub-Slab Soil Gas Wells*, dated March 2007

The comparison, detailed in QAPP Addendum 1, showed that the TO-97 installation methods were functionally equivalent to either guidance document for installation of permanent sub-slab sampling ports. The following small differences between methods were identified:

- the sequence of drilling the 3/8" and 1" holes
- whether the depth of the 1" diameter hole (that serves to hide the fitting below the floor) is fixed at a depth of 1 3/8", or adjusted to the depth necessary to sink the fitting
- whether or not clay is used to help support the cement before it dries.

The New Jersey VIG also allows for the installation of temporary ports and the permanent and temporary port types have different construction methods, materials, and surface seals. The NJ VIG permanent port consists of an assembly of stainless steel tubing and Swagelok fittings which are cemented into a hole drilled into the slab, allowing the sampler to repeatedly access the sample point. In contrast the NJ VIG temporary port procedure allows the use of flexible tubing rather than stainless steel, sealed into a hole in the slab with “modeling clay, beeswax or other non-volatile emitting and non-shrinking materials...”. EPA Region 2 staff has observed (see correspondence in Appendix A of QAPP Addendum 1) that the temporary ports are often used and they are commonly sealed with clay or bentonite. EPA Region 2 requested testing of permanent ports versus temporary points sealed with bentonite to determine whether the seals are adequate to prevent indoor air from infiltrating into the subsurface during sampling and the methods achieve comparable results.

A typical application of a bentonite seal may take one of two approaches:

- *Method 1.* With the tubing in the drill hole, dry bentonite (granular or powdered) is poured into the annular space, sprayed with water, allowed to hydrate, and then smoothed at the surface, with edges feathered to make a seal with the floor and tubing. Complete hydration and full coverage of bentonite in the annular space cannot be ensured using this method. A Teflon tape wrap on the tubing, required by the NJ VIG, may be effective in preventing any liquids not taken up by the bentonite from falling into the sub-slab sample space, but this cannot be ensured. Another potential issue with this method is the degree of hydration and continuity of the bentonite beneath the surface.
- *Method 2.* Bentonite is mixed in a container, starting with water, then adding bentonite until no free water is present and the mixture has the consistency of gel or modeling clay. The mixture is applied to the top 1-2 inches of tubing (above the Teflon tape barrier required by the NJ VIG) as it is twisted into the drill hole, and as needed at the surface to fill the remaining annular space and make a seal with the floor and tubing. This method would appear to be more reliable in preventing liquids from passing the Teflon barrier, but may also fail to provide an even seal beneath the surface.

A seal installed using either of these methods is potentially subject to air leakage because the flexible tubing is likely to move during sampling, possibly opening a pathway for air entry. The seal also depends on the properties of the bentonite, which are likely to change as the bentonite dries. The second bentonite mixing method described above was used for Task 2E.

1.2 Objectives

The primary objective of TO-97 is to investigate distributional changes in VOC and radon concentrations in the indoor air, sub-slab, and subsurface from an underground source (groundwater source and/or vadose zone source) adjacent to a residence or small commercial building. Addendum 1 to the QAPP added the following goal, which is addressed in this report:

- Compare the quality of sub-slab vapor samples collected from permanent and temporary sub-slab ports when the seal for the temporary port is constructed of bentonite, and the temporary tubing is an allowable flexible material consistent with the New Jersey VIG.

The major elements of this task were:

- Installation of Temporary Sub-Slab Ports. On the interior of the building, five new temporary sub-slab ports were installed. Each temporary port was paired with and installed within 30 cm of an existing permanent port.
- Sub-Slab Soil Gas Sampling. Soil gas samples from the temporary sub-slab ports were collected simultaneously with samples from the permanent ports using Method TO-15.
- Other Monitoring. Tracer gas leak testing of sub-slab ports was performed using helium and handheld air testing instruments.

2. Methods

The quality objectives and criteria for Task 2E are described below. The test matrix for Task 2E is indicated in Tables 1 and 2.

Study Question: Qualitatively Stated (from SOW Objectives when applicable).

Identify differences in functions and results between permanent and temporary sub-slab probes.

Study Question: Quantitatively /Statistically Stated.

- (1) Is there a statistically significant difference between analyte concentrations in gas samples collected from permanent and temporary sub-slab probes?
- (2) Is there a measureable amount of leakage of indoor air into either type of probe during sample collection?

Measurement Used To Support Study Question.

- (1) Radon and VOC measurements in sub-slab soil gas samples
- (2) Tracer gas (helium) measurements in sub-slab soil gas samples

Measurement Performance or Acceptance Criteria for this question/# of data points anticipated.

- (1) Agreement of sub-slab concentrations within +/-30 percent is expected to be adequate given the variable nature of sub-slab soil gas distribution.

Helium concentrations indicative of significant leakage are addressed in the QAPP.

For each comparison 5 pairs of measurements were available.

Table 1. Test Matrix: Sample Number, Frequency and Location

Matrix	Sample/Measurement Type	Sample Integration Time or Frequency	Estimated Number of Primary Sample Measurements	Number of QA Samples/Measurements				Total Number of Samples/Measurements	Locations
				Duplicate	Equip Blank	Field Blank	Ambient		
Interior sub-slab soil gas	VOCs, TO-15 Summa Canister	24 hour integrated	6 = One time, simultaneously with the single depth permanent sub-slab ports, sample the five paired temporary sub-slab ports. Numbers represent only the samples from the temporary ports and associated QA	1	0	0	0	6	Interior: 5 single-depth temporary ports to be installed next to five single depth permanent ports.
Interior sub-slab soil gas	Radon	Limit sample flow rate to 200 ml/min or less. Integration time depends on sampler	6 = One time, simultaneously with the single depth permanent sub-slab ports, sample the five paired temporary sub-slab ports. Numbers represent only the samples from the temporary ports and associated QA	1	0	0	0	6	Interior: 5 single-depth temporary ports to be installed next to five single depth permanent ports.

Table 2. Test Matrix: Analytical Methods, Analytes, Laboratory and Turnaround Times

Matrix	Sample/Measurement Type	Analytical Method	Analytes	Laboratory	Special Turnaround Time or Interim Data Analysis Requirements
Interior sub-slab soil gas	VOCs, Summa Canister	TO-15	Project VOC target list	Air Toxics Ltd.	None
Interior sub-slab soil gas	Radon	Alphaguard according to Protocol for Using Continuous Radon Monitors (CR) to Measure Indoor Radon Concentrations http://epa.gov/radon/pubs/devprot3.html#2.1 and EPA 2-56 MOP: Alphaguard: Operation of the Alphaguard Portable R	Radon	Field	None

DRAFT

2.1 Probe Installation and Leak Checks

Single-depth sub-slab ports of both the temporary and permanent type were constructed to test the two types side-by-side. Locations of the paired ports are shown in Figure 1, with each “SSP” indicating a paired temporary and permanent sub-slab port. Each temporary sub-slab port was installed within 30 cm of a single-depth, permanent port.

Temporary single-depth sub-slab probes were constructed in accordance with the SOP in Appendix B of QAPP Addendum 1, from the NJ VIG. The ports were constructed with flexible tubing (Teflon), and were sealed with hydrated bentonite using the following method:

- Mix bentonite in a container, starting with water, and then add bentonite until no free water is present and the mixture has the consistency of gel or modeling clay. Apply the mixture to the top 1-2 inches of tubing (above the Teflon tape barrier required by the SOP and NJ VIG) as it is twisted into the drill hole, and as needed at the surface to fill the remaining annular space and make a seal with the floor and tubing.

For this application, granular bentonite with particle sizes in the medium to fine sand range were used for fast hydration and easy mixing (Benseal uniform granular Wyoming sodium bentonite (grouting bentonite) - Halliburton).

During installation, the adherence of the hydrated bentonite to the slab material and to the tubing was qualitatively noted, as was the apparent continuity of the subsurface portion of the seal as it was installed. During leak checks and sampling, a reasonable effort was made not to move the sample tubing at the ground surface, but visible shrinkage and cracking of the seal was observed and documented as incidental movement of the tubing occurred and as the seal aged and dried out. Photographs of a typical seal as constructed and of each individual seal after sampling are provided in Appendix A to show the effect of aging.

Leak checks were performed on each permanent and temporary port using the tracer gas/shroud method discussed in section 5.3 of the QAPP. Helium gas was used as the tracer. Leak checks were performed before sampling at each permanent port and before and after sampling at each temporary port.

2.2 Sub-Slab Sampling Using Summa Type Canisters for VOCs

Sample collection methods for both temporary and permanent sub-slab ports were as described in QAPP Addendum 1. One round of paired samples was collected from each temporary/permanent pair, for VOCs and radon.

Sub-slab air samples were collected in evacuated, 6-L Summa-type polished canisters. For sub-slab air sample collection, a brass or stainless NPT to Swagelok union fitting was used to connect vapor probes to a “T” fitting made of a stainless steel flexible line and an in-line valve. A portable vacuum pump was used to purge vapor probes and sampling lines for one minute at a flow rate of 0.1 to 0.2 liter per minute (LPM). Immediately after the in-line valve on the pump end of the “T” fitting was closed, the Summa canister valve was opened to collect a grab sample at a maximum rate of 0.1 to 0.2 LPM. The larger sizes of Summa canisters are equipped with an adjustable critical orifice with back pressure regulator that is calibrated at the

laboratory for a target fill time of 24 hours. The sampling start and end times are reported in Table 3. The SOP called for sampling to cease when canister pressure decreased to within 2 to 7 in Hg. Two samples, temporary port 3 and permanent port SSP 1 were observed to be insufficiently filled after 24 hours and were continued for 45-48 hours. One ambient background sample was also collected for comparison to the soil gas samples. Samples from SSP 5 and ambient had gone to 0 in Hg as observed in the field but were observed to have some small vacuum with a more sensitive gauge upon receipt in the lab. Given that these two were in relatively low temperature locations and that many of the other canisters were at 3.5 in Hg or less we expect but cannot prove that these two canisters filled only slightly more rapidly than the canisters that had small but observable vacuums in the field after 24 hours.

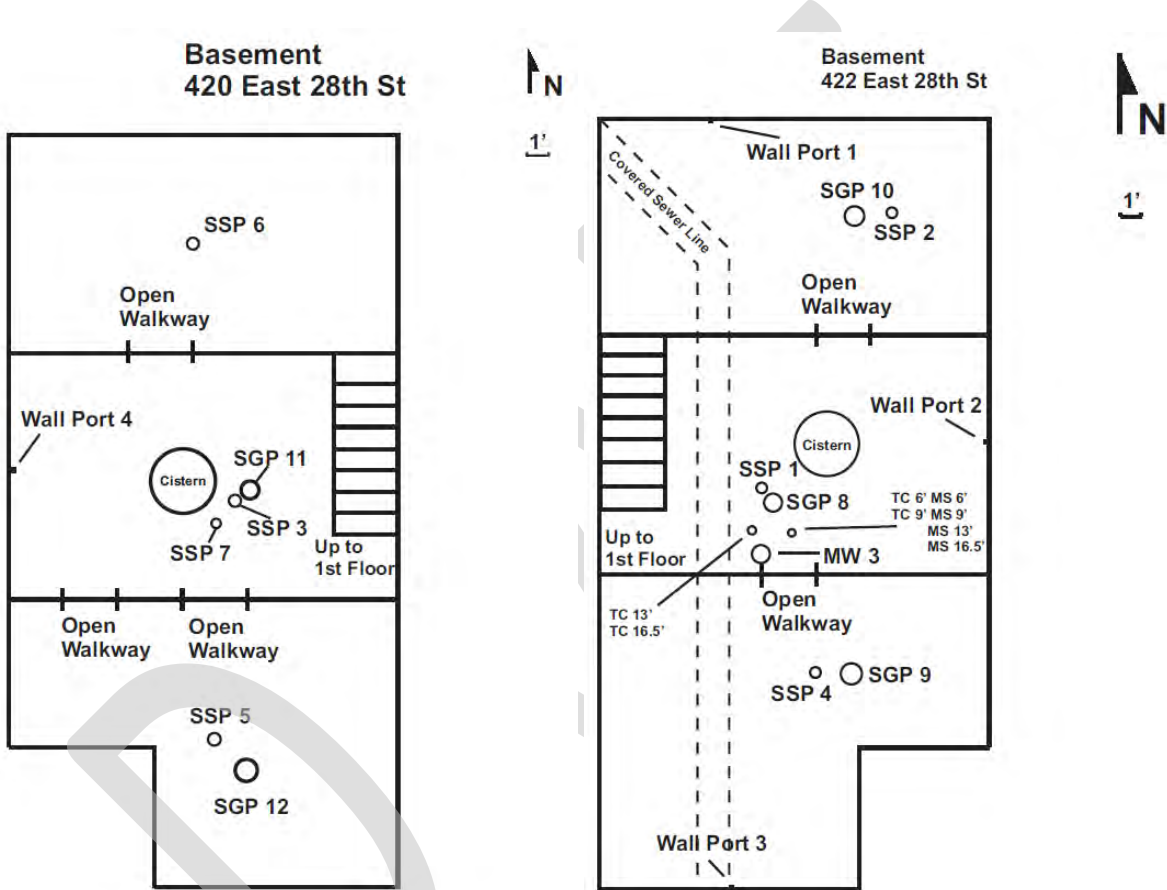

Figure 1. Interiors of test buildings, showing soil gas points (SGP) and paired single-depth temporary and permanent sub-slab ports (SSP).

Table 3. Summa Canister Sampling Times and Pressures

Port #	Can #	Flow Controller #	Initial Vacuum Recorded in Field ("Hg)	Final Vacuum ("Hg) Recorded in Field	Final Vacuum Measured at Lab	Start date	Start time	End date	End time	Sampling Duration (hh:mm)	Date Received at Lab
SSP 5	5619	40376	29	0	0.6 psi	11/30/2010	19:09	12/1/2010	18:53	23:44	12/4/2010
Temp port 5	12011	40597	29	1.5	1.5 "Hg	11/30/2010	19:23	12/1/2010	19:23	24:00	12/4/2010
SSP 3	5766	40259	29	2.5	2.5 "Hg	11/30/2010	19:34	12/1/2010	18:58	23:32	12/4/2010
Temp port 3	14008	40487	28.5	2	1.0 "Hg	11/30/2010	16:30	12/2/2010	16:34	48:02	12/4/2010
Ambient	4338	6010	28	0	0.4 psi	11/30/2010	19:57	12/1/2010	19:02	23:55	12/4/2010
SSP 4 Temp	12687	40281	30	3	3.5 "Hg	11/30/2010	19:48	12/1/2010	19:59	24:11	12/4/2010
SSP 4 Temp DUP	4181	40085	30	1.5	2.0 "Hg	11/30/2010	19:48	12/1/2010	18:48	23:00	12/4/2010
SSP 1 Temp	12669	40324	29.5	2	2.5 "Hg	11/30/2010	19:27	12/1/2010	19:27	24:00	12/4/2010
SSP 1	35245	40145	30	3	3.0 "Hg	11/30/2010	19:27	12/2/2010	16:34	45:07	12/4/2010
SSP 2	31442	40522	30	1.5	1.5 "Hg	11/30/2010	19:15	12/1/2010	18:40	23:25	12/4/2010
SSP 2 Temp	5738	40658	30	2.5	2.5 "Hg	11/30/2010	19:15	12/1/2010	19:32	24:17	12/4/2010
SSP 4	13345	40701	30	5.5	5.0 "Hg	11/30/2010	19:48	12/1/2010	21:27	25:39	12/4/2010
SSP 4 DUP	12940	40060	30	3.5	3.5 "Hg	11/30/2010	19:48	12/1/2010	18:48	23:00	12/4/2010

DRAFT

3. Results

3.1 Seal Integrity

According to the NJ guidance:

"Another method employs a shroud or plastic sheeting placed around the sample probe. An inert tracer gas (such as helium) is released under the sheeting. The initial soil gas samples (after purging) can be monitored using field-screening instruments for elevated concentrations (>5%) of the tracer gas (based on the original tracer gas concentration in the shroud)."

All of the port seals easily passed this leak test criteria when initially installed. However the leak check integrity of the temporary ports declined with time as measured with the helium shroud test (Table 4). As shown in Appendix A, all of the bentonite seals had visible dessication cracks when photographed on December 3rd, several days after installation. This cracking was beginning to be visible at the end of the 24 hour sampling period as well.

We suspect given the visible cracks in the bentonite, that the ability of the seals to pass the post test leak test is primarily attributable to the careful use of Teflon tape around the tube as part of the sealing process, as required by the NJ guidance. It should also be noted that the effectiveness of the seal is not expected to be solely dependent on the construction methods for the seal. From first principles we would expect that the seal effectiveness would also be dependent on:

- The air permeability of the subslab soil and the flow rate of sampling
- The degree to which the field staff can hold the tube immobile during the attachment of sampling equipment and sampling.
- The humidity of the air around the clay portion of the seal and thus the rate of dessication, if several hours or days are expected to pass between the creation of the seal and the completion of sampling.

Table 4. Leak Test Results for Temporary Probes

(expressed as percentage of detected helium concentration in port of the measured helium concentration in the shroud)

Location	Leak (%)		
	11/30/2010 (before sampling, nondetects calculated as	11/30/2010 (before sampling, nondetects calculated at	12/6/2010 (after sampling)
Temporary SSP 1	0.070	0.070	0.365
Temporary SSP 2	0.126	0.126	0.288
Temporary SSP 3	0.000	0.003	0.174
Temporary SSP 4	0.000	0.003	0.636
Temporary SSP 5	0.000	0.003	0.850

3.2 VOC Sampling Results

The VOCs detected in soil gas at concentrations markedly different than the ambient sample were PCE, chloroform, and TCE (as shown in Figures 2-4; and in a data table in Appendix B). Results for PCE, chloroform and TCE were very similar for the paired permanent and temporary sampling ports. The data set shows considerable spatial variability around the subslab (subbasement) area of the pair of duplexes studied, demonstrating the utility of collecting multiple subslab samples in even relatively small structures. The highest concentrations appear in the central and southern portions of the 422 East 28th St. side of the duplex.

If:

- only the data set from only the temporary ports were used, OR
- the data set from only the permanent ports were used,

it is highly likely that a practitioner would have reached the same site management decision using either data set.

{Note: We Are looking at statistical comparisons between the paired samples to show that there was no significant difference.}

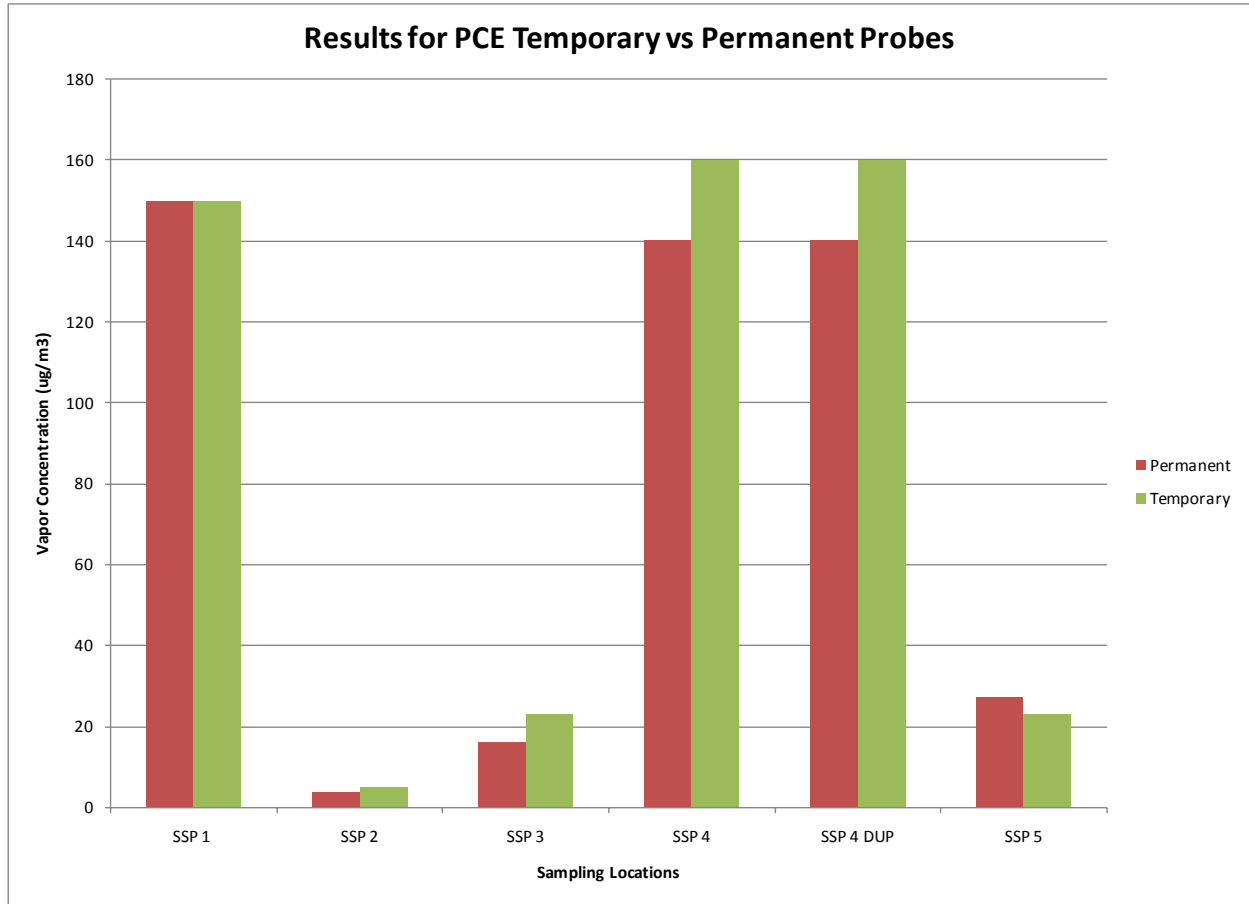

Figure 2. PCE concentrations in soil gas from temporary and permanent subslab probes.

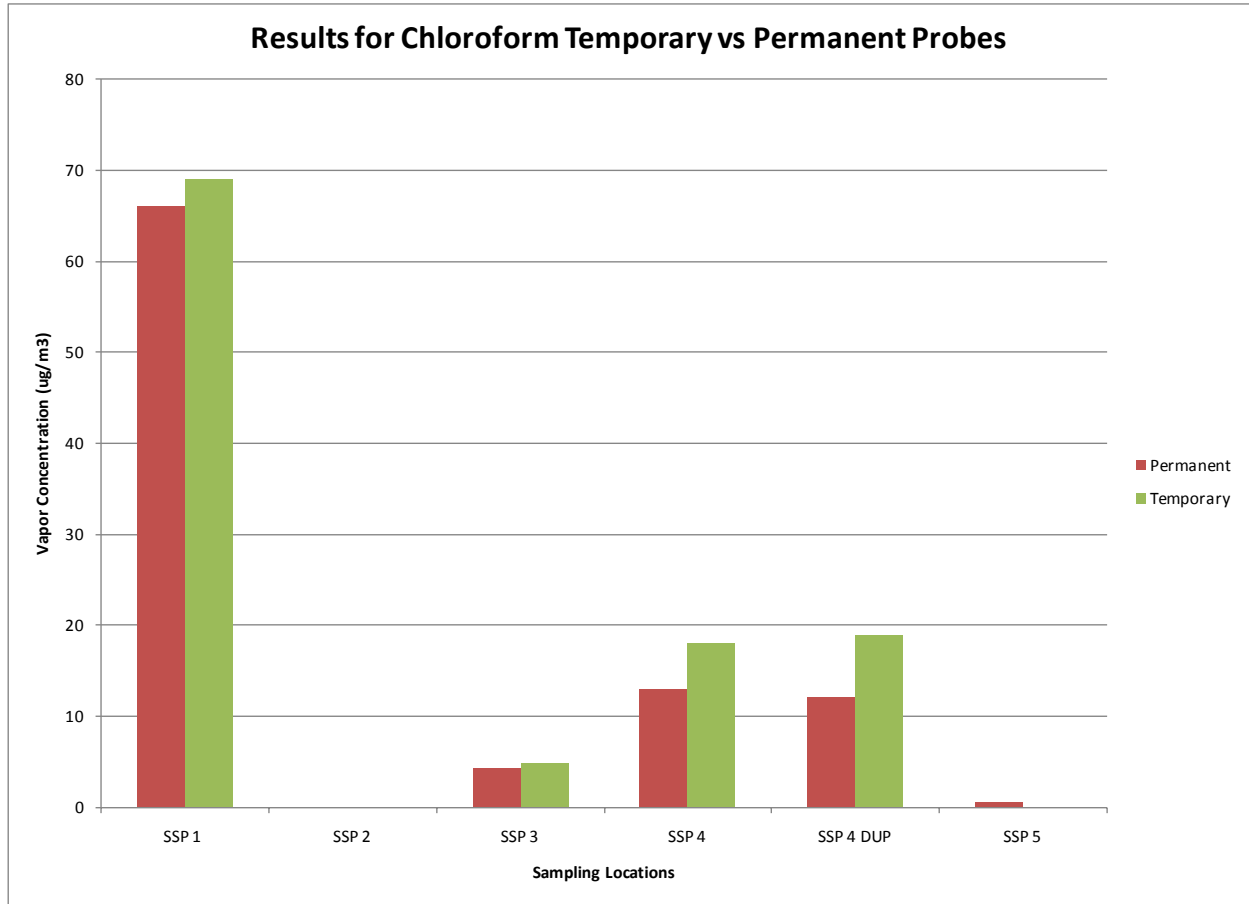

Figure 3. Chloroform concentrations in soil gas from temporary and permanent subslab probes.

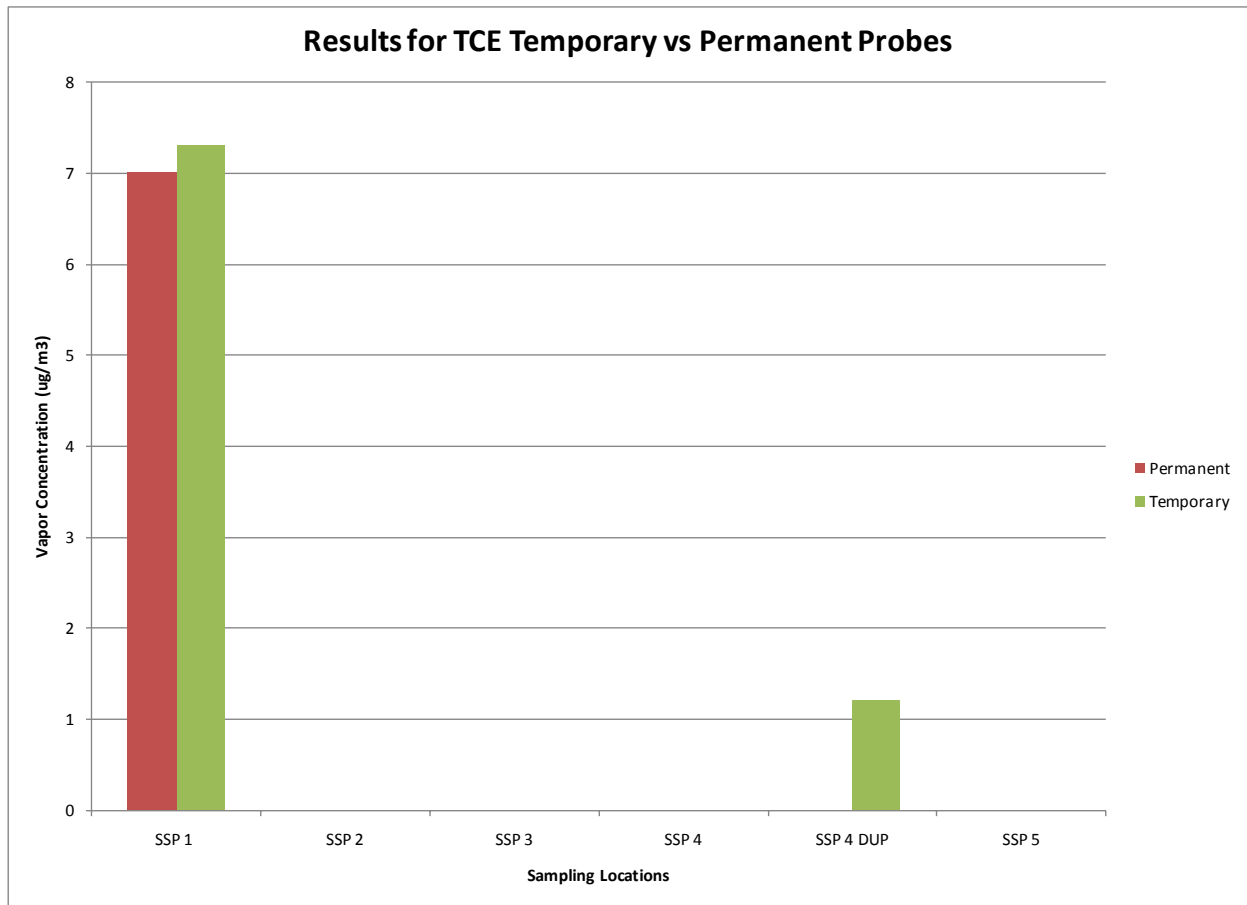

Figure 4. TCE concentration in soil gas from temporary and permanent subslab probes.

3.3 Radon Results

As shown in Table 5, there was also relatively good agreement between short term field radon measurements in soil gas made after the VOC sampling in both the temporary and permanent ports, except in SSP3. The radon concentration in temporary port SSP3 was substantially higher than in the permanent port at that location. Variability between short term field radon measurements in soil gas made before and after the VOC sampling was also greatest in location SSP3. This may suggest that port SSP3 is located at an area with a sharp gradient in radon concentrations over a small area.

3.4 Study Limitations

We would like to caution about several limitations of our conclusions:

- This study was performed at only one site. Based on first principles, the demands on seal performance are likely to be greatest in subslab sample ports in structures constructed directly on low permeability soils.

- The temporary ports installed in this study were under the direct field supervision of a highly experienced staff member who has installed numerous ports over several years. We did not make any attempt to evaluate the variability in seal quality of ports installed by workers of varying levels of experience.
- This study did not examine whether the repetitive sampling over many months, which is a primary purpose of permanent sample port installation, would have yielded a different result than one time use of either permanent or temporary ports.
- This study evaluated only one seal material, bentonite clay. The NJ guidance quoted allows a number of different materials “modeling clay, beeswax or other non-volatile emitting and non-shrinking materials” to be used with Teflon tape “to create a snug fit when the tubing is twisted into the hole”. The NY state guidance (2006) includes a somewhat different list of permissible seal materials “the implant should be sealed to the surface with non-VOC-containing and nonshrinking products for temporary installations (e.g., permagum grout, melted beeswax, putty, etc.) or cement for permanent installations.” We are not aware of any studies that have compared the seal quality that can be achieved with these different materials to one another.
- We caution that the term “modeling clay” used in the NJ guidance to describe an acceptable seal material is commonly used for a very broad range of product formulations used for a common artistic and educational purpose. The term can be used for at least four different types of materials 1) products composed primarily of natural mined clay minerals; 2) products produced by combining oils, waxes and clay minerals; 3) those made entirely of organic polymers and 4) those produced dough of flour, cornstarch, oil, water and cream of tartar¹. The organic polymer clays include those primarily composed of polyvinylchloride for example². These have been reported to potentially contain residual vinyl chloride (Stopford, W. 2000).

¹ Three websites accessed December 18, 2010 http://en.wikipedia.org/wiki/Modelling_clay
<http://www.wisegeek.com/what-are-the-different-types-of-modeling-clay.htm>
<http://www.claysculpting.org/modeling-clay/>

² http://cdn.dickblick.com/msds/DBH_33901XXXX.pdf

Table 5. Radon Data Comparing Temporary and Permanent Probes

Location	Radon 11/30/10 Before VOC Sampling	Radon 12/6/2010, After VOC Sampling	
	Permanent Port	Temporary Port	Permanent Port
	pCi/L	pCi/L	pCi/L
SSP 1	1068	735	719
SSP 2	1203	1108	1338
SSP 3	219	1151	543
SSP 4	1865	1659	1708
SSP 5	1089	1214	1089

4. Conclusions

Under the conditions studied here VOC and radon concentrations measured simultaneously in soil gas using nearly collocated temporary and permanent ports appeared to be independent of the type of port. The variability between nearly collocated temporary and permanent ports was much less than the spatial variability between different locations within the same residential duplex. The agreement of concentrations was achieved even though the clay portion of the seal of the temporary ports visibly desiccated and cracked. Post sampling leak test results suggested that this desiccation and cracking was not as detrimental to port seal performance as would have been expected, suggesting that the Teflon tape portion of the seals was serving an important function. Post sampling leak tests are advisable (in addition to presampling leak tests) when temporary ports are used to collect a time integrated sample over a period of several hours.

These results suggest that temporary subslab sampling ports can provide data equivalent to that collected from a permanent subslab sampling port at the same time. However we caution that (1) we tested only one type of seal material in one location, (2) the seals were installed by experts and rigorous quality control, and thus (3) these results may not apply to all types of temporary seals and all building foundations.

5. References

New Jersey Department of Environmental Protection (NJDEP). 2005. *Vapor Intrusion Guidance*. <http://www.nj.gov/dep/srp/guidance/vaporintrusion/viq.htm>)

New York State Department of Health (NYSDOH). 2006. *Guidance for Evaluating Soil Vapor Intrusion in the State of New York*. Center for Environmental Health, Bureau of Environmental Exposure Investigation. Albany, NY. October.

US EPA (Environmental Protection Agency). 2007. *Construction and Installation of Permanent Sub-Slab Soil Gas Wells*. SOP 2082. Response Engineering and Analytical Contract.

U.S. EPA (Environmental Protection Agency). 1999. *Compendium of Methods for the Determination of Toxic Organic Compounds in Ambient Air Second Edition Compendium Method TO-15 Determination Of Volatile Organic Compounds (VOCs) in Air Collected in Specially-Prepared Canisters and Analyzed by Gas Chromatography Mass Spectrometry (GC/MS)*. EPA/625/R-96/010b. At <http://www.epa.gov/ttnamti1/files/ambient/airtox/to-15r.pdf>.

Woodard, S. 2010. *Hazard Risk Assessment from the Use of Polymer Clays*. Division of Occupational and Environmental Medicine, Duke University Medical Center; Durham, NC 27710; http://www.polymerclaycentral.com/cyclopedia/polymerclay_safety.htm May 2000. Accessed December 18, 2010.

DRAFT

Appendix A: Photographs of Seals



Typical Temporary Port Construction Before Sampling



Typical Port Construction Before Sampling, One Temporary port shown at lower end of picture and one Permanent port shown in the middle of the frame



Temp Port 1



Temp Port 1 close up



Temp Port 2 (129 KB)



Temp Port 2 close up



Temp Port 3

DRAFT



Temp Port 3 close up



Temp Port 4

DRAFT



Temp Port 4 close up

DRAFT



Temp Port 5



Temp Port 5 close up

DRAFT



Port 5 additional close up



Effect of tubing movement on bentonite seal after drying has occurred

DRAFT

Appendix B: Data Summary Table

Temporary vs. Permanent Port Study

Summa Canister VOCs Results (showing only VOCs detected or identified at least once)

COMPOUND NAME	Sampling Location	RESULTS (ug/m3)	Qualifier	REPLMT (ug/m3)
Benzene	Ambient Outdoor 422 Back Porch	0.74	J	2.1
Benzene	SSP-1		ND	2.4
Benzene	SSP-1 Temp		ND	2.3
Benzene	SSP-2		ND	2.2
Benzene	SSP-2 Temp	0.47	J	2.3
Benzene	SSP-3		ND	2.3
Benzene	SSP-3 Temp	0.46	J	2.2
Benzene	SSP-4		ND	2.6
Benzene	SSP-4 Dup		ND	2.4
Benzene	SSP4 Temp Dup	1.9	J	2.3
Benzene	SSP-4 Temporary	2.0	J	2.4
Benzene	SSP-5		ND	2.1
Benzene	SSP-5 Temporary	0.89	J	2.2
Carbon Disulfide	Ambient Outdoor 422 Back Porch	1.0	J	2.0
Carbon Disulfide	SSP-1	1.3	J	2.3
Carbon Disulfide	SSP-1 Temp	1.6	J	2.3
Carbon Disulfide	SSP-2	1.3	J	2.2
Carbon Disulfide	SSP-2 Temp	1.3	J	2.3
Carbon Disulfide	SSP-3	1.4	J	2.3
Carbon Disulfide	SSP-3 Temp	1.4	J	2.2
Carbon Disulfide	SSP-4	1.4	J	2.5
Carbon Disulfide	SSP-4 Dup	1.3	J	2.4
Carbon Disulfide	SSP4 Temp Dup	1.7	J	2.2

Initial Draft – 12/21/10 - Do Not Cite or Quote

Carbon Disulfide	SSP-4 Temporary	1.6	J	2.4
Carbon Disulfide	SSP-5	1.1	J	2.0
Carbon Disulfide	SSP-5 Temporary	1.6	J	2.2
Chloroform	Ambient Outdoor 422 Back Porch		ND	3.2
Chloroform	SSP-1	66		3.6
Chloroform	SSP-1 Temp	69		3.6
Chloroform	SSP-2		ND	3.4
Chloroform	SSP-2 Temp		ND	3.6
Chloroform	SSP-3	4.2		3.6
Chloroform	SSP-3 Temp	4.8		3.4
Chloroform	SSP-4	13		3.9
Chloroform	SSP-4 Dup	12		3.7
Chloroform	SSP4 Temp Dup	19		3.5
Chloroform	SSP-4 Temporary	18		3.7
Chloroform	SSP-5	0.55	J	3.1
Chloroform	SSP-5 Temporary		ND	3.4
Hexane	Ambient Outdoor 422 Back Porch		ND	2.3
Hexane	SSP-1		ND	2.6
Hexane	SSP-1 Temp		ND	2.6
Hexane	SSP-2		ND	2.5
Hexane	SSP-2 Temp	1.0	J	2.6
Hexane	SSP-3		ND	2.6
Hexane	SSP-3 Temp		ND	2.4
Hexane	SSP-4		ND	2.8
Hexane	SSP-4 Dup		ND	2.7
Hexane	SSP4 Temp Dup	2.2	J	2.5
Hexane	SSP-4 Temporary	1.9	J	2.7
Hexane	SSP-5		ND	2.3
Hexane	SSP-5 Temporary	1.3	J	2.5
Methylene Chloride	Ambient Outdoor 422 Back Porch	2.1	J	2.2
Methylene Chloride	SSP-1		ND	2.6

Initial Draft – 12/21/10 - Do Not Cite or Quote

Methylene Chloride	SSP-1 Temp	2.1	J	2.5
Methylene Chloride	SSP-2	1.2	J	2.4
Methylene Chloride	SSP-2 Temp		ND	2.5
Methylene Chloride	SSP-3		ND	2.5
Methylene Chloride	SSP-3 Temp	2.7		2.4
Methylene Chloride	SSP-4		ND	2.8
Methylene Chloride	SSP-4 Dup		ND	2.6
Methylene Chloride	SSP4 Temp Dup		ND	2.5
Methylene Chloride	SSP-4 Temporary		ND	2.6
Methylene Chloride	SSP-5		ND	2.2
Methylene Chloride	SSP-5 Temporary	0.50	J	2.4
Tetrachloroethene	Ambient Outdoor 422 Back Porch		ND	4.4
Tetrachloroethene	SSP-1	150		5.0
Tetrachloroethene	SSP-1 Temp	150		5.0
Tetrachloroethene	SSP-2	3.7	J	4.8
Tetrachloroethene	SSP-2 Temp	4.8	J	5.0
Tetrachloroethene	SSP-3	16		5.0
Tetrachloroethene	SSP-3 Temp	23		4.7
Tetrachloroethene	SSP-4	140		5.5
Tetrachloroethene	SSP-4 Dup	140		5.2
Tetrachloroethene	SSP4 Temp Dup	160		4.9
Tetrachloroethene	SSP-4 Temporary	160		5.2
Tetrachloroethene	SSP-5	27		4.4
Tetrachloroethene	SSP-5 Temporary	23		4.8
Toluene	Ambient Outdoor 422 Back Porch	0.91	J	2.4
Toluene	SSP-1		ND	2.8
Toluene	SSP-1 Temp	0.84	J	2.8
Toluene	SSP-2		ND	2.6
Toluene	SSP-2 Temp	1.1	J	2.8
Toluene	SSP-3		ND	2.8
Toluene	SSP-3 Temp	1.8	J	2.6

Initial Draft – 12/21/10 - Do Not Cite or Quote

Toluene	SSP-4		ND	3.0
Toluene	SSP-4 Dup		ND	2.9
Toluene	SSP4 Temp Dup	5.9		2.7
Toluene	SSP-4 Temporary	5.2		2.9
Toluene	SSP-5		ND	2.4
Toluene	SSP-5 Temporary	2.0	J	2.6
Trichloroethene	Ambient Outdoor 422 Back Porch		ND	3.5
Trichloroethene	SSP-1	7.0		4.0
Trichloroethene	SSP-1 Temp	7.3		3.9
Trichloroethene	SSP-2		ND	3.8
Trichloroethene	SSP-2 Temp		ND	3.9
Trichloroethene	SSP-3		ND	3.9
Trichloroethene	SSP-3 Temp		ND	3.7
Trichloroethene	SSP-4		ND	4.3
Trichloroethene	SSP-4 Dup		ND	4.1
Trichloroethene	SSP4 Temp Dup	1.2	J	3.9
Trichloroethene	SSP-4 Temporary		ND	4.1
Trichloroethene	SSP-5		ND	3.5
Trichloroethene	SSP-5 Temporary		ND	3.8

Initial Draft – 12/21/10 - Do Not Cite or Quote

Table . Temporary vs Permanent Port Study
Summa Canister VOCs Results (showing only VOCs detected or identified at least once)

COMPOUND NAME	Sampling Location	RESULTS (ug/m3)	Qualifier	REPLMT (ug/m3)
Benzene	Ambient Outdoor 422 Back Porch	0.74	J	2.1
Benzene	SSP-1		ND	2.4
Benzene	SSP-1 Temp		ND	2.3
Benzene	SSP-2		ND	2.2
Benzene	SSP-2 Temp	0.47	J	2.3
Benzene	SSP-3		ND	2.3
Benzene	SSP-3 Temp	0.46	J	2.2
Benzene	SSP-4		ND	2.6
Benzene	SSP-4 Dup		ND	2.4
Benzene	SSP4 Temp Dup	1.9	J	2.3
Benzene	SSP-4 Temporary	2.0	J	2.4
Benzene	SSP-5		ND	2.1
Benzene	SSP-5 Temporary	0.89	J	2.2
Carbon Disulfide	Ambient Outdoor 422 Back Porch	1.0	J	2.0
Carbon Disulfide	SSP-1	1.3	J	2.3
Carbon Disulfide	SSP-1 Temp	1.6	J	2.3
Carbon Disulfide	SSP-2	1.3	J	2.2
Carbon Disulfide	SSP-2 Temp	1.3	J	2.3
Carbon Disulfide	SSP-3	1.4	J	2.3
Carbon Disulfide	SSP-3 Temp	1.4	J	2.2
Carbon Disulfide	SSP-4	1.4	J	2.5
Carbon Disulfide	SSP-4 Dup	1.3	J	2.4
Carbon Disulfide	SSP4 Temp Dup	1.7	J	2.2
Carbon Disulfide	SSP-4 Temporary	1.6	J	2.4
Carbon Disulfide	SSP-5	1.1	J	2.0
Carbon Disulfide	SSP-5 Temporary	1.6	J	2.2
Chloroform	Ambient Outdoor 422 Back Porch		ND	3.2
Chloroform	SSP-1	66		3.6
Chloroform	SSP-1 Temp	69		3.6
Chloroform	SSP-2		ND	3.4
Chloroform	SSP-2 Temp		ND	3.6
Chloroform	SSP-3	4.2		3.6
Chloroform	SSP-3 Temp	4.8		3.4
Chloroform	SSP-4	13		3.9
Chloroform	SSP-4 Dup	12		3.7
Chloroform	SSP4 Temp Dup	19		3.5
Chloroform	SSP-4 Temporary	18		3.7
Chloroform	SSP-5	0.55	J	3.1
Chloroform	SSP-5 Temporary		ND	3.4
Hexane	Ambient Outdoor 422 Back Porch		ND	2.3
Hexane	SSP-1		ND	2.6
Hexane	SSP-1 Temp		ND	2.6
Hexane	SSP-2		ND	2.5
Hexane	SSP-2 Temp	1.0	J	2.6
Hexane	SSP-3		ND	2.6
Hexane	SSP-3 Temp		ND	2.4
Hexane	SSP-4		ND	2.8
Hexane	SSP-4 Dup		ND	2.7
Hexane	SSP4 Temp Dup	2.2	J	2.5
Hexane	SSP-4 Temporary	1.9	J	2.7
Hexane	SSP-5		ND	2.3
Hexane	SSP-5 Temporary	1.3	J	2.5
Methylene Chloride	Ambient Outdoor 422 Back Porch	2.1	J	2.2
Methylene Chloride	SSP-1		ND	2.6
Methylene Chloride	SSP-1 Temp	2.1	J	2.5
Methylene Chloride	SSP-2	1.2	J	2.4
Methylene Chloride	SSP-2 Temp		ND	2.5
Methylene Chloride	SSP-3		ND	2.5
Methylene Chloride	SSP-3 Temp	2.7		2.4
Methylene Chloride	SSP-4		ND	2.8
Methylene Chloride	SSP-4 Dup		ND	2.6
Methylene Chloride	SSP4 Temp Dup		ND	2.5
Methylene Chloride	SSP-4 Temporary		ND	2.6
Methylene Chloride	SSP-5		ND	2.2
Methylene Chloride	SSP-5 Temporary	0.50	J	2.4
Tetrachloroethene	Ambient Outdoor 422 Back Porch		ND	4.4
Tetrachloroethene	SSP-1	150		5.0

Appendix C

Additional Correlograms for Ambient and Indoor Air

Chloroform and Radon - Air samples, Location =AMBIENT

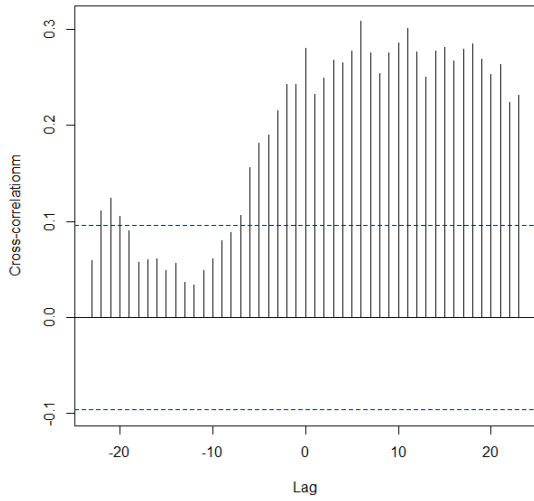

Tetrachloroethene and Radon -Air samples, Location =AMBIENT

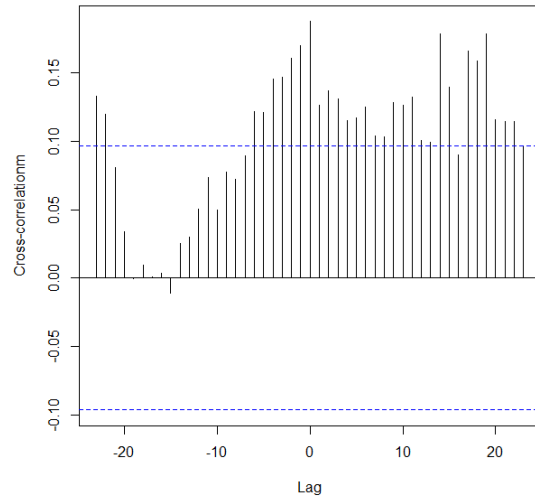

Chloroform and Radon - Air samples, Location =420BaseN

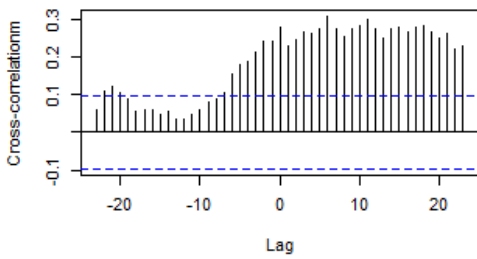

Tetrachloroethene and Radon -Air samples, Location =420BaseN

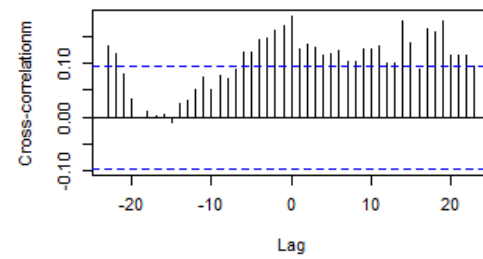

Chloroform and Radon - Air samples, Location =420BaseS

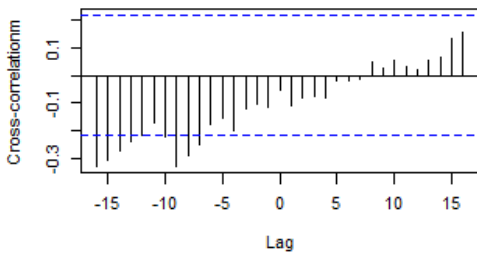

Tetrachloroethene and Radon -Air samples, Location =420BaseS

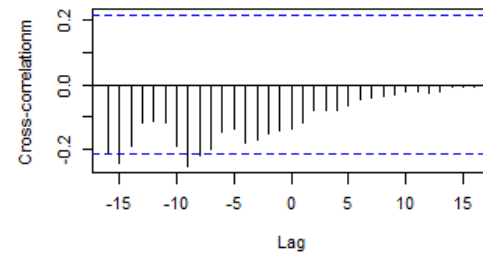

Chloroform and Radon - Air samples, Location =420First

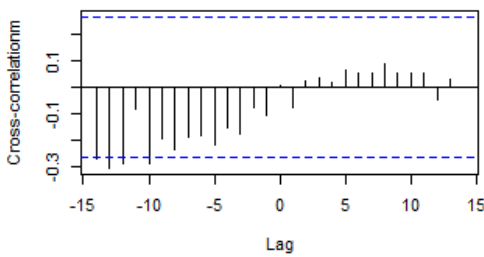

Tetrachloroethene and Radon -Air samples, Location =420First

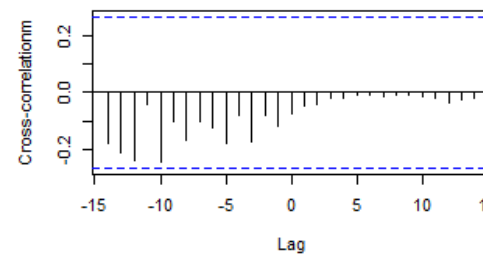

**Chloroform and Radon - Air samples,
Location =422BaseN**

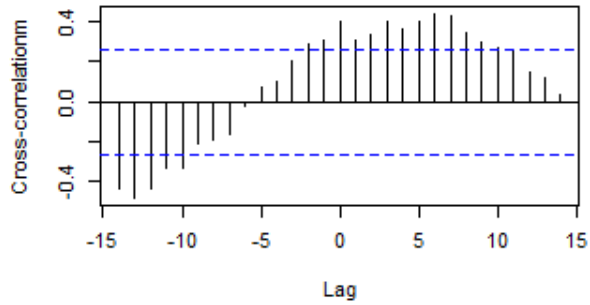

**Tetrachloroethene and Radon -Air samples,
Location =422BaseN**

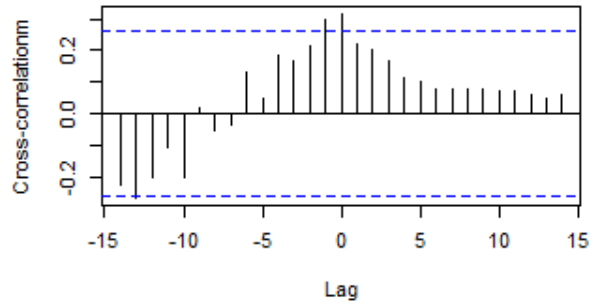

**Chloroform and Radon - Air samples,
Location =422BaseS**

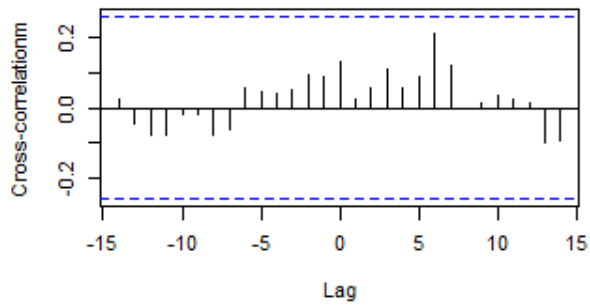

**Tetrachloroethene and Radon -Air samples,
Location =422BaseS**

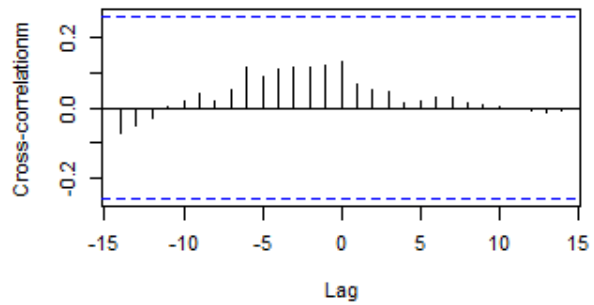

**Chloroform and Radon - Air samples,
Location =422First**

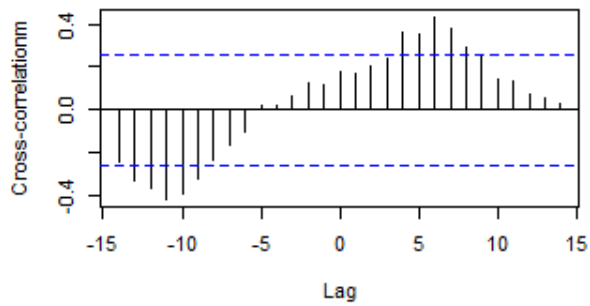

**Tetrachloroethene and Radon -Air samples,
Location =422First**

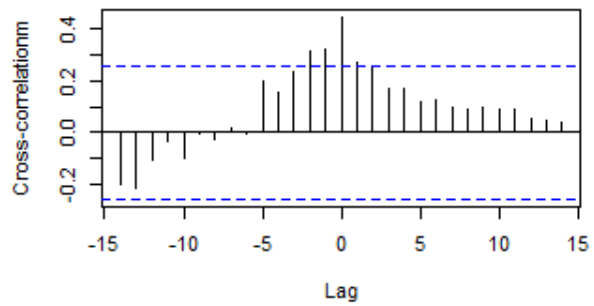

Chloroform and Radon - Air sampletrachloroethene and Radon -Air san
Location =AMBIENT

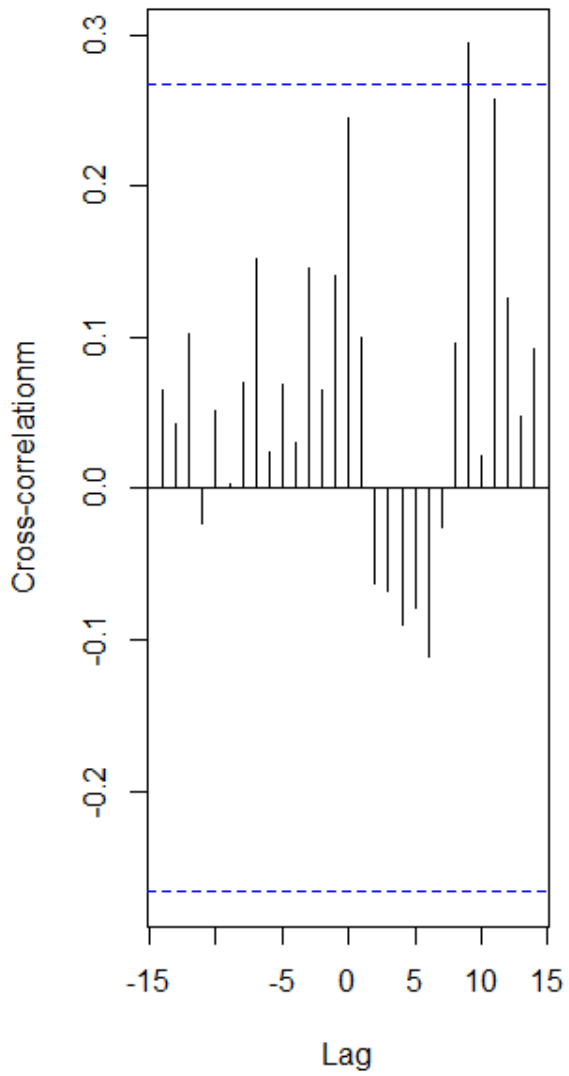
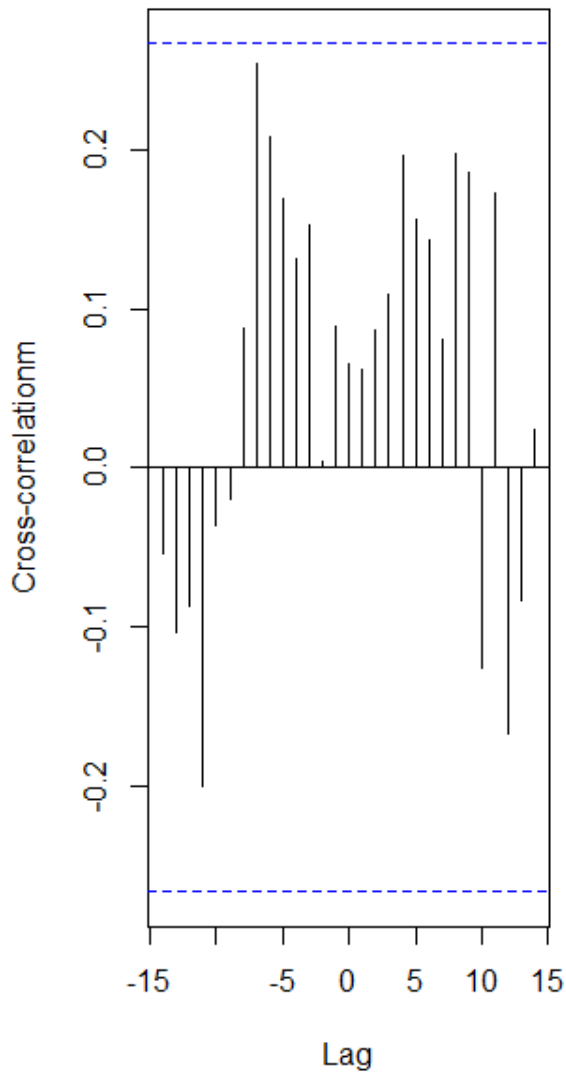



Please make all necessary changes on the below label, detach or copy and return to the address in the upper left hand corner.

If you do not wish to receive these reports CHECK HERE ; detach, or copy this cover, and return to the address in the upper left hand corner.

PRESORTED STANDARD
POSTAGE & FEES PAID
EPA PERMIT No. G-35

Office of Research
and Development (8101R)
Washington, DC 20460

Official Business
Penalty for Private Use
\$300

EPA/600/R-12/673
September 2012
www.epa.gov



Recycled/Recyclable
Printed with vegetable-based ink on
paper that contains a minimum of
50% post-consumer fiber content
processed chlorine free