

**CONCEPTUAL REMEDIAL DESIGN PLAN
FORMER ROMIC ENVIRONMENTAL TECHNOLOGIES
CORPORATION FACILITY
2081 BAY ROAD
EAST PALO ALTO, CALIFORNIA**

PREPARED FOR:

Mr. Wayne Kiso
Chief Executive Officer
Romic Environmental Technologies Corporation
2500 Tanglewilde, Ste 470
Texas, 77063

PREPARED BY:

Ninyo & Moore
Geotechnical and Environmental Sciences Consultants
1956 Webster Street, Suite 400
Oakland, California 94612

February 5, 2014
Project No. 402212001

February 5, 2014
Project No. 402212001

Mr. Wayne Kiso
Chief Executive Officer
Romic Environmental Technologies Corporation
2500 Tanglewilde, Ste 470
Houston, Texas 77063

Subject: Conceptual Remedial Design Plan
Former Romic Environmental Technologies Corporation Facility
2081 Bay Road
East Palo Alto, California

Dear Mr. Kiso:

In accordance with your request, Ninyo & Moore has prepared this Conceptual Remedial Design Plan (CRDP) for the Former Romic Environmental Technologies Corporation Facility located at 2081 Bay Road in East Palo Alto, California. This CRDP was prepared following guidelines presented by the United States Environmental Protection Agency (US EPA).

We appreciate the opportunity to be of service to you on this project.

Sincerely,
NINYO & MOORE

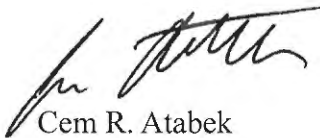

Cem R. Atabek
Senior Project Engineer



Duane W. Blamer, PG
Manager, Environmental Sciences

CRA/KML/DWB/caa

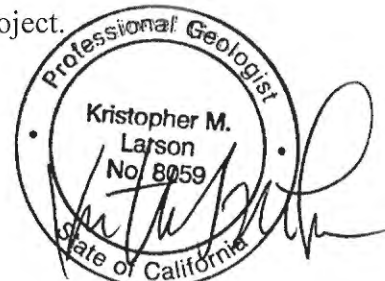

Kris M. Larson, PG 8059
Principal Environmental Geologist

- Distribution: (1) Addressee
(1) Mr. Ron Leach, United State Environmental Protection Agency
(1) Ms. Katherine Baylor, United State Environmental Protection Agency
(1) Ms. Lori Koch, California Department of Toxic Substances Control
(1) Mr. Mark Johnson, San Francisco Bay Regional Water Quality Control Board
(1) Mr. Chris Alger, Iris Environmental
(3) Mr. Ray Tate, American Gas & Technology

TABLE OF CONTENTS

	<u>Page</u>
EXECUTIVE SUMMARY.....	1
1. INTRODUCTION.....	2
2. SITE SETTING AND BACKGROUND.....	3
2.1. SITE AQUIFERS.....	5
2.2. VOLATILE ORGANIC COMPOUND GROUNDWATER PLUME.....	6
2.3. FUTURE CLIMATIC CONDITIONS.....	6
2.3.1. Existing Concrete Slab Restoration.....	7
2.3.2. Seasonal Storm-Water Accumulation and Management of Existing Concrete Slab.....	8
3. PROPOSED REMEDIAL ACTIONS.....	8
4. REMEDIAL ACTION DISCUSSION.....	9
4.1. IN SITU DELIVERY (ISD™).....	10
4.2. SOIL REMEDIATION.....	10
4.3. GROUNDWATER REMEDIATION.....	15
4.3.1. Additional Subsurface Evaluation and Testing.....	16
4.3.2. Separate Phase Hydrocarbon Removal.....	17
4.3.3. ISD™ System Approach.....	17
4.3.4. ISD™ System Installation.....	19
4.3.5. ISD™ Equipment Description.....	23
4.3.6. Treatment Substrate Selection and BTEX Amendments.....	26
4.3.7. Pump and Injection Testing.....	28
4.3.8. Implementing Current Enhanced Reductive Dechlorination Injection Program.....	30
5. REMOVAL OF SUBSURFACE FEATURES.....	30
6. SITE COVER.....	30
6.1. GEOTECHNICAL EVALUATION.....	31
6.2. SITE COVER DESIGN AND INSTALLATION.....	32
7. RISK MANAGEMENT PLAN AND SITE-SPECIFIC HEALTH AND SAFETY PLAN.....	33
8. SOIL VAPOR MITIGATION SYSTEMS.....	34
8.1. SUB-SLAB VENTILATION SYSTEM INSTALLATION.....	35
8.2. VAPOR BARRIER MEMBRANE SYSTEM INSTALLATION.....	35
8.3. INSTALLATION OVERSIGHT AND INSPECTION.....	35
8.4. UTILITY CONDUIT SEALS.....	35
8.5. UTILITY TRENCH DAMS.....	36
8.6. SOIL VAPOR MITIGATION SYSTEM OPERATIONS & MAINTENANCE PLAN.....	36
9. DESIGN STRATEGY AND BASIS.....	36
10. SOIL VAPOR, GROUNDWATER AND SURFACE-WATER MONITORING PROGRAM.....	37
10.1. SOIL VAPOR MONITORING.....	37

10.2. GROUNDWATER MONITORING.....	38
10.3. SURFACE WATER MONITORING.....	39
10.4. SEMI-ANNUAL GROUNDWATER AND SURFACE WATER SAMPLING REPORTS	39
10.5. RECONSTRUCTION, NEW CONSTRUCTION AND DECOMMISSIONING OF SITE WELLS	40
11. ASSUMPTIONS	40
12. COST ESTIMATE FOR REMEDY DESIGN, IMPLEMENTATION, AND OPERATION AND MAINTENANCE.....	41
13. REFERENCES.....	42

Tables

Table 1 – Cost Schedule

Table 2 – Quarterly Project Cost Breakdown and Project Schedule

Figures

Figure 1 – Site Location

Figure 2 – Site Plan

Figure 3 – Proposed Remediation Infrastructure for Vadose Zone and A-Zone Aquifer

Figure 4 – Site Geologic Cross Section A-A

Figure 5 – Proposed Remediation Infrastructure for B-Zone Aquifer

Figure 6 – Proposed Remediation Infrastructure for C-Zone Aquifer

Appendices

Appendix A – ETEC Case Studies and Technical Information

EXECUTIVE SUMMARY

Ninyo & Moore has prepared this Conceptual Remedial Design Plan (CRDP) on behalf of the Romic Environmental Technologies Corporation (Romic). This CRDP was requested from Romic by the US Environmental Protection Agency (US EPA), the lead agency overseeing the corrective action at the former Romic Environmental Technologies Corporation Facility (Romic Facility) located at 2081 Bay Road in East Palo Alto, California (site). This CRDP presents a conceptual plan to address contaminated soil and groundwater at the former Romic Facility consistent with US EPA's July 2008 Remedy Decision.

The Romic Facility site is a 12.6-acre property that was historically used as a hazardous waste management facility whose services included solvent recycling, fuel blending, wastewater treatment, and hazardous waste storage and treatment. During facility operations conducted by Romic and its predecessor companies dating back to the mid-1950's, both soil and groundwater were contaminated at the site. The primary contaminants of concern are chlorinated and aromatic volatile organic compounds (VOCs), mostly composed of solvents. Other contaminants are also present, including metals (e.g. lead), polychlorinated biphenyls (PCBs), fuel related compounds, including petroleum hydrocarbons, and semi-VOCs (e.g. naphthalene). The facility was closed and dismantled in 2009.

The Romic Facility is currently a Resource Conservation and Recovery Act (RCRA) site undergoing corrective action and closure. The US EPA is the lead agency for corrective action and the California Department of Toxic Substances Control (DTSC) is the lead agency for closure. The US EPA coordinates closely with the DTSC and Regional Water Quality Control Board (RWQCB) in reviewing corrective action documents including this CRDP. The US EPA prepared a Final Remedy Decision in 2008 (Remedy), which included enhanced biological treatment used together with monitored natural attenuation (MNA) for site cleanup. The Remedy also included some soil excavation and removal in certain areas of the site. A site-wide investigation to determine the full extent of the contamination at the site has already been performed and compiled as a report by Iris Environmental. The report, dated June 12, 2013 was provided to all Regulatory Agencies involved with oversight of the cleanup and is available online at the US EPA website.

In order to expedite soil and groundwater remediation on site and allow for site redevelopment, Ninyo & Moore has teamed with ETEC, LLC Environmental Technologies (ETEC) in creating an efficient soil and groundwater remediation plan utilizing biologic treatment and groundwater recirculation. This plan will utilize many of the existing wells on site as part of system operations, which will include extracting VOC-impacted groundwater, and pumping the extracted groundwater into a holding tank where it will be treated with substrate and surfactants, and re-injected into the subsurface A-, B-, and C-zone aquifers. The system will operate until cleanup objectives are achieved or until MNA is deemed appropriate. This remediation technology is considered the best available technology for treating site soil and groundwater, and is within the Remedy guidelines approved for the site.

1. INTRODUCTION

Ninyo & Moore is pleased to present this Conceptual Remedial Design Plan (CRDP) for the property located at 2081 Bay Road in East Palo Alto, California (site) (Figure 1).

This document follows CRDP guidelines presented by the United States Environmental Protection Agency (US EPA) in a letter to the Former Romic Environmental Technologies Corporation (Romic) prepared on April 26, 2013 (Romic 2013a). This CRDP also includes responses throughout the text relating to the Joint Agency (JA) Comments for the *draft CRDP, Former Romic Environmental Technologies Corporation Site, East Palo Alto, California, dated June 6, 2013* (Romic 2013b), and the *Joint Agency Comments on the Conceptual Remedial Design Plan, Former Romic Environmental Facility, East Palo Alto, California, dated September 13, 2013* (Romic 2013c).

According to the April 26th US EPA letter, the CRDP should include the following elements.

- A detailed description of the proposed remedial action.
- A discussion of how the proposed remedial action meets the five performance standards specified in the US EPA's 2008 Final Remedy Decision for the Romic Environmental Technologies Corporation Facility (Remedy) (US EPA 2008). The standards include:
 - protect human health and the environment;
 - attain media cleanup objectives;
 - remediate the source of releases;
 - control off-site migration of contaminated groundwater; and
 - limit potential for vapor intrusion into structures.
- A discussion of the design strategy and the design basis, including technical factors of items such as: 1) the constructability of the design; and 2) use of currently acceptable construction practices and techniques.
- Figures showing areas where the proposed Remedy will be implemented and applicable, including cross-section diagrams depicting the subsurface.
- Reference for non-standard treatment options being proposed (i.e. vadose zone flooding) with a list of successful applications at other properties.
- A description of the proposed groundwater and surface-water monitoring programs, including the installation and monitoring of new wells.

- A description of the assumptions made and detailed justification of these assumptions.
- A detailed and justified cost estimate for constructing, operating and maintaining the proposed remedy.

Based on the remedy performance standards, this CRDP is organized into the following sections:

- Section 2 –Site Setting and Background;
- Section 3 – Proposed Remedial Actions;
- Section 4 - Remedial Action Discussion;
- Section 5 – Removal of Subsurface Features;
- Section 6 – Site Cover;
- Section 7 – Risk Management Plan and Site –Specific Health and Safety Plan;
- Section 8 – Soil Vapor Mitigation System;
- Section 9 – Design Strategy and Basis;
- Section 10 – Soil Vapor, Groundwater and Surface Water Monitoring Program;
- Section 11 – Assumptions;
- Section 12 – Cost Estimate for Remedy Design, Implementation, and Operation and Maintenance; and
- Section 13 - References.

2. SITE SETTING AND BACKGROUND

The site is approximately 12.6 acres and is bordered on the east and north by the Ravenswood Open Space Preserve (ROSP), Bay Road and a vacant property to the south, and commercial properties and Tara Road to the west. The site was previously utilized by Romic and its predecessor companies dating back to the mid-1950's as a hazardous waste management facility whose services included solvent recycling, fuel blending, wastewater treatment, and hazardous waste storage and treatment.

Numerous environmental reports have been prepared for the site, one of the most recent being a Revised Comprehensive Site-Wide Sampling and Analysis Program Report (CSAP) conducted by IRIS Environmental (Iris, 2013). The CSAP tasks included the collection, sampling and analysis of site-wide soil samples, with the heaviest concentration of samples collected from the former Central Processing Area, Western Area, and the former waste ponds in the Northern Area of the site (Figure 2). The CSAP concluded that site soils were impacted with volatile organic compounds (VOCs) consistent with historical data, and that the areas with the most Risk-Based Target Concentration (RBTC) exceedences were in the Northern, Western, and the Central Processing Areas. Impacts to soil were also reported from polychlorinated biphenyl's (PCBs), Title 22 metals, and fuel-related compounds.

During early site characterization groundwater monitoring wells were sampled and analyzed for VOCs, semivolatile organic compounds (SVOCs), Title 22 metals, and PCBs. Current groundwater samples are analyzed for VOCs only. With the exception of VOCs, each of these constituents has been reported in wells at concentrations that are not considered a risk to potential receptors. Volatile organic compounds have been detected at elevated concentrations in several areas of the site. Dense, non-aqueous phase liquids (DNAPL) are also believed to be present in areas where elevated concentrations of VOCs have been detected in soils, including the Northern and Central Processing Areas.

According to the First and Second Quarter 2013 Semi-annual Report prepared by Arcadis, dated August 16, 2013 (Arcadis 2013), VOC contamination in soil and groundwater is divided into three source areas on site, including:

- the former pond area beneath the northern drum storage buildings;
- the process area in the center of the facility; and
- the southwestern portion of the facility.

Both the former pond area (Northern Area) and the process area (Central Processing Area) are areas where former Romic Environmental Technologies Corporation Facility (Romic Facility) activities contributed to site contamination. No chemicals were reportedly handled or managed in the southwestern portion of the facility, which was purchased by Romic in the late 1980s. Regard-

ing distribution of VOCs in site groundwater, the highest concentrations and frequency of VOC detections have been reported in the Central Processing Area.

2.1. Site Aquifers

Three aquifers, identified as the A-, B- and C-zones, are located between the surface and approximately 80 feet (ft) below ground surface (bgs). A D-zone aquifer underlies the C-zone and is separated by an approximately 80-foot-thick aquitard. A cross section of site lithology is presented on Figure 4.

The A-zone aquifer is approximately 22 ft thick and is composed of interbedded clays, sands, and gravels and overlies a discontinuous clay aquitard that is reportedly 13 ft thick in some areas. According to the Arcadis report, the A-zone groundwater elevations generally range from 2 to 8 ft above mean sea level (msl), and groundwater flow is primarily toward the sloughs northeast of the site.

The B-zone aquifer has been classified as semi-confined with a stratigraphy of interbedded fine sands and silts, and clay lenses. The aquifer ranges from 5 to 27 ft in thickness and overlies a clay aquitard ranging between 3 to 22 ft in thickness. The bottom of the B-zone aquifer is approximately 60 ft bgs, and groundwater flow direction is toward the east-northeast in the direction of the sloughs.

The C-zone stratigraphy is composed of poorly to well-sorted sands, silty sands, and clays. The unit ranges between 3 to 25 ft thick and overlies an 80-foot-thick regional aquitard composed of dense clays and silts. The bottom of the C-zone aquifer is approximately 80 ft bgs. There reportedly is an upward groundwater gradient that flows in the direction of the sloughs in the C-Zone aquifer.

The D-zone aquifer is located approximately 160 ft bgs, is approximately 30 ft thick, and is composed of fine to coarse sands, gravels, and minor clay lenses.

2.2. Volatile Organic Compound Groundwater Plume

The existing VOC-impacted groundwater plume underlies most of the site within both the A- and B-zone aquifers, and has migrated off site to the northeast in these zones and to the off-site surface water of the adjacent sloughs. Specific VOC constituents, including tetra-chloroethene (PCE), trichloroethene (TCE), cis 1,2-dichloroethene (Cis 1,2-DCE), vinyl chloride (VC), toluene, total xylenes and ethylbenzene have also been reported in milligrams per liter (mg/L)-concentrations in both the A- and B-zone aquifers. VOCs have also been detected within the C-zone aquifer; however, based on available information the C-zone is generally less contaminated than the B-zone. Groundwater monitoring data indicates that the most significant impacts from VOCs in the C-zone are localized within the immediate vicinity of monitoring wells RW-2C and RW-19C in the Northern Area, with less significant impacts to groundwater in the Central Processing Area. Volatile organic compound impacts to A- and B-zone aquifers appear to be site-wide with the exception of the panhandle area to the south and southwest.

Our proposed remedial actions discussed below focus on the remediation of the A-zone and B-zone aquifers with groundwater recirculation; however, we will also treat C-zone wells using primarily injection treatment (as opposed to both extraction and injection).

2.3. Future Climatic Conditions

The US EPA has expressed concern for potential impacts from long-term sea level and groundwater elevation increases. To assess the potential impacts of sea level rise, Ninyo & Moore compared site topography and depth to groundwater data with adjacent San Francisco Bay levels. The lowest elevation of the on site concrete surface is located in the eastern section of the Central Processing Area in the vicinity of the former truck scales and below the former employee parking lot. The elevation of the concrete surface in this area is approximately 3- to 4-ft above msl, and historical groundwater monitoring data from the nearest A-zone monitoring well (well RW-12A) indicates that groundwater is typically encountered between approximately 1-to 2-ft bgs in this area. Recent groundwater monitoring data from well RW-12A indicates an increase in the average depth to groundwater of ap-

proximately 3 ft starting in December 2010; however, this change is attributed to the installation of a riser that is approximately 3 ft tall.

Groundwater has been observed to periodically reach or approach the bottom of the current concrete surface in the Central Processing Area, therefore increases in sea level over time could cause the site to become inundated in its current configuration; however, it should be noted that the site is currently separated from the adjacent tidelands by an approximately 8- to 9-foot-high levee. Plans for future site development include raising the elevation of the site by at least 3 ft using imported fill materials. Raising the site elevation would mitigate potential inundation concerns associated with sea-level rise for the foreseeable future.

2.3.1. Existing Concrete Slab Restoration

According to Romic, holes in the concrete pavement made during the CSAP investigation are required to be filled and patched to reestablish concrete slab integrity. Romic also reported that the concrete pavement surface was cracked in two locations during removal of process tank supports in the former production area. Repair of these two cracked locations and the boring core holes would be performed in order to restore the existing pavement. In addition to the above repairs, a full site inspection of the concrete pavement will be conducted with a General Contractor (GC) with the intent to repair any voids in the concrete pavement by the GC. The repairs will include several sections of the former Tank Farm Q area where raised tank platforms are not capped with concrete pavement. Several of the platforms have soft bottoms reportedly filled with sand that were used as a base for some of the tanks. This area is currently covered with what appears to be a high density polyethylene (HDPE) liner. All of the platforms that do not have concrete pavement will be capped with new concrete. Following these repairs, and during the transition period to the new treatment system, semi-annual concrete pavement inspections would be performed as part of a formal Operations and Maintenance (O&M) Plan, and repairs and maintenance would be performed, as necessary, to maintain the integrity of the concrete pavement. It is expected that the current concrete pavement surface can maintain the same physical barrier as currently observed.

2.3.2. Seasonal Storm-Water Accumulation and Management of Existing Concrete Slab

According to Romic, during historical facility operations a sump and pump system were used to transfer rainwater accumulation on the existing concrete slab from a low spot near the former office building (Figure 2) to a storage tank and processing location. Since closure of the facility, seasonal rainfall has been observed to accumulate in the Central Processing Area in the vicinity of the former truck scales and below the former employee parking lot. Romic indicated that, if and when the accumulated water rises to a pre-determined level, the water will be tested, as it currently is, for compliance to discharge requirements established by the National Pollution Discharge Elimination System (NPDES) program under a standard permit. Once testing confirms compliance, the water is discharged to the San Francisco Bay via an existing piping network and documented on an annual basis. This method is cost-effective and can reasonably be continued into the future, as necessary, if the site is not developed.

Because the site elevation is planned to be raised and covered with a new site cover as discussed in Section 6 below, the estimated costs for storm-water management/discharge and maintenance of the existing concrete slab includes (at a maximum) a period of up to three years during site development.

3. PROPOSED REMEDIAL ACTIONS

Proposed remedial actions for on-site soil include irrigating vadose zone soils with a mixture of recirculated water, substrate and surfactant, and remediating site groundwater with a similar substrate mixture also using the recirculation method. Additional alternatives were considered for vadose zone soils in the Northern Area, including a soil vapor extraction treatment system (SVETS) and a thermal oxidizer. Based on our findings, the best available technology to treat the soil impacts in the Northern and Central Processing Areas appears to be the irrigation and saturation of vadose zone soils with substrate, amendments and surfactant materials (treatments).

The proposed remedial action for impacts from VOCs in the Northern Area and Central Processing Area vadose zone soils includes the installation of horizontal injection wells in shallow trenches, which will be connected to an In Situ Delivery (ISD™) groundwater recirculation system. The intent of the ISD™ system is to extract, add treatments and reinject groundwater. The vadose zone thickness of the Northern Area is approximately 6 to 10 ft bgs, and the vadose zone thickness in the Central Processing and Western Areas is up to 2 ft bgs during dry periods. Groundwater depths sometimes reach the bottom of the site concrete slab during the winter; so on occasion the vadose zone is nonexistent in the Central Processing and Western Areas.

The installation and O&M of an ISD™ groundwater recirculation system is also our proposed remedial option to effectively treat VOC-impacted groundwater within the A-zone, B-zone, and C-zone aquifers beneath the site. The ISD™ systems will remove contaminant mass and expedite enhanced reductive dechlorination (ERD) of chlorinated solvents and aerobic biodegradation of fuel-related compounds in site matrices.

In addition to the remedial actions discussed above, we also propose to design and install a new site cover to prevent direct contact with underlying contaminated soils. The site cover will include placement of a minimum of 3 ft of clean fill material over the existing concrete slab, and installation of hardscape materials (asphalt and concrete) overlying the clean fill. The existing concrete will act as a demarcation layer between the contaminated soils beneath the existing concrete slab and clean fill above. In addition to the proposed site cover, soil vapor mitigation systems (SVMSs) will be designed and installed beneath any future or proposed site buildings to mitigate potential soil vapor intrusion to indoor air.

4. REMEDIAL ACTION DISCUSSION

This section discusses our proposed remedial actions for the site, including the testing, installation and O&M of the ISD™ groundwater recirculation system, and conceptual design of the site cover. We also discuss further evaluation of site VOCs in groundwater and lithologic classification for environmental and geotechnical purposes, and options for soil vapor mitigation for the proposed site buildings.

4.1. In Situ Delivery (ISD™)

Our proposed treatment option to remediate VOC-impacted vadose zone soils within the Northern Pond, Central Processing and Western Areas is the installation of horizontal injections wells, which will be connected to an ISD™ groundwater recirculation system (system). The ISD™ system will be designed and installed by ETEC, and involves the recirculation of groundwater for delivery of anaerobic substrates to the subsurface to promote complete anaerobic dechlorination of chlorinated solvents (to ethenes and ethanes), followed by monitored natural attenuation (MNA) of chlorinated solvents. Once the MNA indicates that chlorinated solvents have reached an asymptotic state, the US EPA will be petitioned for approval to allow the ISD™ system changeover for the delivery of aerobic substrates to promote aerobic biodegradation of fuel-related compounds.

4.2. Soil Remediation

As discussed above, historical groundwater monitoring data indicates that groundwater in the Central Processing/Western Area is often encountered within 2 ft bgs, and groundwater periodically reaches or approaches the bottom of the concrete slab, indicating that the vadose zone often extends to less than 2 ft bgs. The vadose zone is much thicker in the Northern Area, sometimes reaching a thickness of 10 ft. Soil in these two areas has been impacted with elevated concentrations of VOCs, specifically chlorinated solvents and fuel-related VOCs, with many concentrations exceeding 1,000 milligrams per kilogram (mg/kg). Our approach to remediate VOC-impacted vadose zone soils is through irrigating the vadose zone soils with amendment-enhanced recirculated groundwater.

Water Content/Field Saturation of Vadose Zone: The ISD™ system will remediate VOCs within vadose zone soils by injecting treated groundwater through horizontal piping installed in shallow trenches between 6 to 12 inches bgs in the Central Processing Area and between 12 to 24 inches bgs in the Northern Area. Even distribution of the amended groundwater will be achieved by utilizing Air Diffusion System (ADS)-slotted piping that facilitates even distribution of solutions due to the specific design of the piping (surgical slotting that opens at specific pressures). The treated groundwater will spread laterally beneath the concrete slab

in the more permeable sandy/gravelly material, which, according to CSAP boring logs, is prevalent beneath the majority of the concrete slab and ranges in depth from approximately 6 inches to 3 ft bgs. The sub-slab lateral spreading action will allow the treated groundwater to infiltrate and remediate impacted vadose zone soil throughout the Northern, Central Processing and Western Areas. In order to promote chemical oxidation of constituents of concern (COCs), desorption of COCs from soil matrix, and increase the effective porosity of the soil formation, a 3 to 5% diluted hydrogen peroxide solution will be injected into the irrigation gallery prior to injecting either the surfactants or amendments.

Each irrigation trench will have its own independent irrigation line in order to have a high degree of control of the flow rate and total volume that each trench will receive. The trench irrigation lines will be connected to the ISD™ system, and controlled by the programmable logic control (PLC) component, which will inject the amended water in intermittent pulses. The system will maintain ideal microbial conditions (i.e. pH, moisture content, nutrients, etc.) in the vadose zone throughout this remedial process. Figure 3 illustrates a plan view of the proposed configuration of shallow irrigation trenches within these areas.

The effectiveness of vadose zone remediation through irrigation/saturation will be evaluated by monitoring pore water in a combination of vadose zone piezometers and shallow A-zone monitoring wells. This method of evaluating contaminants will help determine the relationship of VOC degradation in vadose zone soil pore water to the proposed irrigation treatment.

Boring logs from the CSAP indicate that there are several permeable fill horizons within the Northern Area vadose zone, which will be ideal for pore water monitoring with the use of piezometers. The Central Processing Area vadose zone is a more modest 3 ft in thickness; however, because this area will also be irrigated, it will be monitored during treatment. All piezometers used for vadose zone monitoring will be placed in a manner that allows for ascertaining the degree of saturation achieved by the system operation. The system PLC will be adjusted as needed (i.e. irrigation times/rates) until saturation reaches the desired level (field capacity) in the vadose zone.

Vadose Zone Monitoring: In order to monitor contaminant removal/dechlorination and aerobic degradation in the vadose zone a method will be utilized that is dependent on groundwater parameters. The groundwater parameter method uses several ‘lines of evidence’ that will be correlated together (spatially and temporally) to provide quantifiable data that can be used to evaluate the degree of remediation achieved in the vadose zone. The overall premise is that groundwater percolating through the vadose zone will be in equilibrium with the impacted vadose zone soil, since there will be a moderate contact time between the two media as the percolation occurs. As the relatively un-impacted and treated groundwater percolates through the impacted vadose zone, the sorbed contaminants (high concentration) will partition to the groundwater phase (low concentration) based on partitioning coefficients and basic fate-and-transport phenomenon that occur in the subsurface environment. As long as distribution of the fluids in the vadose zone is achieved and a high degree of saturation throughout the remedial phase is maintained, this method should provide lines of evidence that contaminant mass removal has been achieved. The information below describe, in detail, the multiple ‘lines of evidence’ we will collect in order to provide the data required for the regulatory agencies to determine if the proposed treatment of the vadose zone VOCs appears to be effective and should continue.

When evaluating the lines of evidence, the evaluation of fluid flow (percolation and moisture content) of the vadose zone during the remedial phase is first and foremost. This will be accomplished by installing a total of 22 of the aforementioned piezometers at two different horizons (approximately 3 to 4 and 7 to 8 ft bgs) within only the Northern Area to evaluate the degree of saturation achieved with specific flow rates/volumes the system is delivering to the shallow irrigation trenches (Figure 3). Piezometers will not be installed in the Central Processing Area because of the shallow nature of the groundwater in that area.

Because the irrigation system is not designed to continuously inject water (due to the pulsed delivery), the piezometers will be dry during those periods when the injection ceases and the treated water percolates downward. The vadose zone, however, will not lose saturation to where it becomes dry to any degree. This is because each trench will be irrigated numerous

times throughout the day, allowing capillary forces to hold a high degree (near field capacity) of water while irrigation is not occurring. This saturated environment will also allow the bacteria to continue to thrive and degrade contaminants. Because the pulsating action will irrigate to the point where only temporary piezometer well water will be available, only those piezometers where irrigation is occurring will be monitored for moisture.

In order to collect water quality parameters (WQPs) and sample for VOCs, seven new 1-inch-diameter vadose zone monitoring wells will be installed 2 to 3 ft below the vadose zone/A-zone interface in the Northern Area (Figure 3). The wells will be screened into the A-zone to ensure that there is enough recharge capacity in the wells to collect groundwater samples. Because the vadose zone in the Central Processing Area is so shallow, six new 1-inch-diameter shallow groundwater monitoring wells (rather than piezometers) will be installed in this area. The wells will be installed no deeper than 2 to 3 ft below the top of the A-zone at the proposed well locations in the attached Figure 3.

Water Quality and Biological Parameter Monitoring: The treated irrigation water will cause the WQPs to shift in values that will indicate whether or not vadose zone treatment is effective. Monitored WQPs will include pH, conductivity, oxidation reduction potential (ORP), and dissolved oxygen (DO) via a flow through cell. Biological parameters will include nitrate, ammonia, sulfate, total organic carbon (TOC), and methane/ethene/ethane through laboratory analysis. The treatment process will cause an increase in conductivity, and the introduction of TOC will cause the ORP to move toward a negative value over time. The presence of TOC will be very critical to show that the distribution of the substrate is occurring throughout the treatment area since this is the primary bioamendment responsible for stimulating biodegradation. If these shifts in WQPs and biological parameters are not observed, it is indicative of the lack of treatment compounds reaching a specific area. If there is no water quality shifts in a specific area, that area is likely not receiving treatment and biodegradation is probably not occurring. In addition to DO and ORP, pH is the WQP that is most critical for bioremediation to be successful. The pH will be monitored for the ideal measurements (five to eight standard units) for bacteria to remain active. Detections of

methane/ethene/ethane will also be evidence we are achieving complete dechlorination of the vadose zone chlorinated solvents. The vadose zone monitoring for WQPs and biological parameters will continue during treatment for benzene, toluene, ethylbenzene and xylenes (BTEX) compounds, and will include monitoring for ammonia, nitrate, sulfate, dissolved ferrous iron, and sulfide. The depletion of nitrate and sulfate, and an increase in production of dissolved ferrous iron and sulfide will indicate that biodegradation of BTEX compounds is occurring.

Volatile Organic Compound Monitoring: The VOC data from the shallow monitoring wells will also be used to show increases and decreases in contaminant concentrations over time and space as the remedial process is implemented. The vadose zone irrigation will initially displace and flush out trapped non-aqueous phase liquids (NAPL), likely causing a temporary spike in shallow A-zone aquifer VOC concentrations. The surfactants will also aid in the desorption of the vadose zone mass, causing an increase in groundwater concentrations in the underlying A-zone aquifer. Because of this increase in A-zone VOCs, the potential for creating a toxic environment to the existing site bacteria may be a concern. In order to maintain healthy bacteria, the groundwater pH will be monitored monthly during the first month of treatment and adjustments can be made to maintain the proper pH level during remediation.

Vadose Zone and A-Zone Groundwater Monitoring Well Sample Collection and Analysis: The rise (flushing/desorption) and fall (via biodegradation) of the VOCs over time will be correlated with the WQP and biological data mentioned above to further examine the effectiveness of the vadose zone irrigation and treatment. Ideally, the WQP, biological parameters, and VOC data will be correlated to indicate active remediation in the saturated vadose zone. This will likely require the evaluation of at least three to six quarters of groundwater WQP and VOCs data from all the newly-installed vadose zone wells and select existing A-zone groundwater monitoring wells in order to obtain a trend line for each of the parameters over time. Ideally, after six quarters (18-months), enough data will be generated to indicate the degree of communication and treatment being achieved in this area. The va-

dose zone and A-zone monitoring well sampling locations and schedule for all parameter analysis will be included in the Corrective Measures Implementation Program Plan (CMIPP). The recommended sampling schedule for these wells includes:

- collecting baseline samples for WQP, biological parameters, and VOC analysis prior to ISD™ system operation start-up;
- collecting monthly samples for WQP, biological parameters, and VOC analysis during the first quarter after treatment has commenced; and
- collecting quarterly samples for WQPs, biological parameters and VOCs during the first year of treatment.

Once the data is evaluated, the PLC will be adjusted, as needed, by increasing the irrigation times/volumes to specific areas in order to overcome any limitations that are observed. In the case that certain piezometers do not show the desired moisture, or particular vadose zone wells do not indicate a decrease in VOCs, a contingency plan will be prepared to discuss further investigation and/or treatment options to promote vadose zone treatment.

Analyzing WQP, biological parameters and VOC data each month for the first quarter is an important step in the remediation process, because this period is the most transformative time (initial system startup) when these parameters will be the most dynamic. In order to indicate the parameter correlation and treatment effectiveness we will plot the WQPs, biological parameters, and VOCs. Ultimately, the parameter results and VOC analysis will be used to evaluate when monitored natural attenuation (MNA) is appropriate.

Additional details regarding the ISD™ and ISD™ O&M activities are discussed in the sections below, and a more detailed explanation of the location, vertical placement, and monitoring schedule of the piezometers and vadose zone monitoring wells will be included in the CMIPP.

4.3. Groundwater Remediation

The ISD™ treatment system for groundwater will be designed and installed by ETEC to promote site-wide and complete anaerobic dechlorination of chlorinated solvents (to ethenes

and ethanes), and aerobic biodegradation of fuel-related compounds. This system has successfully remediated elevated VOC impacts to groundwater in similar subsurface environments, and copies of case studies and links to additional technical information are provided in Appendix A.

4.3.1. Additional Subsurface Evaluation and Testing

Prior to installation of the ISD™ system, further site subsurface evaluation and testing will be conducted to obtain detailed lithologic information, which will be used to determine the precise depths at which horizontal remediation wells (HRWs) will be installed to target the appropriate permeable soil zones. The site characterization activities will also evaluate whether DNAPL is present in areas of the site. Further lithologic classification will be conducted primarily within the Central Processing, Western and Northern, and Tank Farm Q Areas in preparation for installation of the HRWs. Up to 18 borings will be advanced along the planned lateral extent of the HRWs within the A- and B-zone, and the borings will extend to the top of the B/C aquitard, which is anticipated to be approximately 50 to 60 ft bgs. Twelve of these borings will also extend to the C-zone aquifer in the Northern, Tank Farm Q, and the Central Processing Areas in order to evaluate VOC impacts to the C-zone aquifer. The borings will be advanced using direct-push technology, which will be equipped with the appropriate direct-reading instrumentation to assist in lithologic characterization and determining the presence of DNAPL. The direct reading instrumentation will include the use of cone penetrometer testing (CPT) methods or a high resolution injection tool (HRIT) for lithological characterization, coupled with a membrane interface probe (MIP) for evaluation of impacts from VOCs. Subsequent to the CPT/MIP investigation, groundwater samples will be collected from those areas where the quantitative MIP information has indicated elevated VOC concentrations. The approximate boring locations will be included in a subsurface investigation work plan submitted to and approved by the US EPA prior to field activities.

4.3.2. Separate Phase Hydrocarbon Removal

Because a layer of separate-phase hydrocarbons (SPH) has been observed in site monitoring wells RW-11A and RW-8B (which are planned to be used for groundwater extraction), removal of SPH using skimming pumps will be performed prior to groundwater extraction. The SPH was measured to be approximately 0.38 ft thick in monitoring well RW-11A and approximately 0.51 ft thick in monitoring well RW-8B during the 1st Quarter 2013 groundwater monitoring event. A layer of SPH was also observed in site monitoring well RW-20B during the 1st Quarter 2013 groundwater monitoring event; however, the instrumentation used for measurement was reportedly not adequate to measure the enhanced thickness of the SPH. Removal of SPH will also be performed in monitoring well RW-20B prior to operation of the ISD™ treatment system in this area. Removal of SPH would include pumping the product into a temporary holding tank, and subsequently pumping the holding tank contents into a vacuum truck and transporting it to the appropriate disposal facility.

4.3.3. ISD™ System Approach

The available data indicates that application of the ISD™ system can successfully deliver treatment to each groundwater zone to support accelerated, aggressive anaerobic and aerobic treatment within a reasonable timeframe. However, because of the size of the impacted area, HRWs will need to be installed within the A and B-zone aquifers. Vertical injection wells will be utilized to treat the C-zone aquifer.

By utilizing the ISD™ system in a groundwater recirculation configuration, artificial groundwater gradients can be produced within the VOC plume to induce cycling of treated groundwater throughout the impacted A- and B-saturated zones where the bulk of the VOCs are sorbed to the organic fraction of the soil matrix. With active contact in these zones, remediation and migration control of the dissolved-phase plume can be achieved. These artificial gradients will be critical for the full-scale treatment scenario in order to remediate the large impacted area.

Based on the historical information and groundwater monitoring well data from the 2013 Arcadis groundwater monitoring report, the target zone dimensions and groundwater conditions are as follows:

A-Zone: Depth to groundwater has been reported between 2 to 5 ft bgs, with groundwater flow towards the east (toward the adjacent ROSP). The target saturated thickness for this zone is approximately 5 to 22 ft bgs. The lateral extent of impacts in this zone covers most of the site with the exception of the southeastern portion. Groundwater concentrations of PCE, TCE, cis-1, 2-DCE, and VC in the treatment zone range from less than 1.0 microgram per liter ($\mu\text{g/L}$) up to 12 mg/L (hot spots are RW-28A, RW-8A, RW-9A, RW-11A, and RW-27A). Groundwater BTEX concentrations in the Central Processing Area range from less than 1.0 $\mu\text{g/L}$ (RW-12A) up to 272 $\mu\text{g/L}$ (RW-8A), and in the Northern Area they exceed 400 $\mu\text{g/L}$ (RW-28A).

B-Zone: The target saturated thickness for this zone is approximately 22 to 60 ft bgs. The lateral extent of impacts in this zone covers most of the site with the exception of the southeastern portion. Groundwater concentrations of PCE/TCE/Cis-1,2-DCE/VC in the treatment zone range from less than 10 $\mu\text{g/L}$ up to 45 mg/L (hot spots are EW-2B, EW-1B, RW-5B, RW-19B, RW-22B, RW-11B, RW-8B, RW-16B, RW-21B, and RW-17B). Groundwater BTEX concentrations in the Central Processing Area range from less than 76 $\mu\text{g/L}$ (EW-1B) up to 2.28 mg/L (EW-2B), and in the Northern Area range from 20 $\mu\text{g/L}$ to 368 $\mu\text{g/L}$ (EW-1B).

Available groundwater data and parameters (i.e. VOCs, DO, pH, and ORP) indicate subsurface conditions that represent anoxic to anaerobic conditions. The negative ORP indicates that the presence of petroleum hydrocarbons and/or the injection of molasses and cheese whey has driven the aquifer into anaerobic conditions, causing the generation of cis-1,2-DCE, VC, and ethene. Groundwater pH is near neutral.

The significant detections of cis-1,2-DCE, VC and ethane indicate complete reductive dechlorination is likely occurring via the indigenous microbes in the saturated zones;

therefore, bio-augmentation will not be required. The significant detections of daughter products indicate complete PCE compound reduction through bioremediation is already occurring and that the ISD™ system will successfully remediate the site.

C-zone: The targeted thickness of this aquifer is approximately 60 to 80 ft bgs. The highest reported VOC concentrations are located in the vicinity of well RW-19C, where concentrations of PCE/TCE/Cis-1,2-DCE and VC were reported in the range of 10/65/120 and 900 µg/L, respectively. Elevated BTEX (primarily toluene, ethylbenzene and total xylenes at 900, 350 and 150 µg/L, respectively) compounds were also reported in this well. The only other well where appreciable concentrations were detected includes RW-2C, where TCE, Cis-1,2-DCE and VC were reported at 30, 30 and 25µg/L, respectively. Both of these wells are located in the northern section of the site.

C-zone groundwater parameters, VOCs, DO, pH, and ORP, were similar to the B-zone in that the historically negative ORP and low DO concentrations indicate that the groundwater conditions are anaerobic. There is also evidence the PCE daughter products have formed in areas where the current carbohydrate source injection has been applied, indicating that the ISD™ system will successfully remediate the remaining low to moderate VOC concentrations within the C-zone aquifer.

4.3.4. ISD™ System Installation

The ISD™ system will include several existing A- and B-zone site vertical wells for groundwater extraction and injection, plus several new HRWs and vertical wells for treatment injection into the A-, and B-zones. Any existing monitoring wells converted for injection or extraction purposes will be replaced with new groundwater monitoring wells. There will also be several existing C-zone vertical injection wells used, and several new injection wells installed to treat the C-zone. However, because groundwater extraction is not planned for the C-zone, no new extraction wells will be installed in the C-zone aquifer. Details of the precise locations of the wells will not be finalized until after the proposed subsurface investigation is completed.

A more detailed description of the system installation and O&M follows, and plan views with the approximate locations of the A-zone, B-zone, and C-zone ISD™ systems are illustrated on Figures 3, 5, and 6, respectively.

4.3.4.1. A-Zone

Because the ISD™ system depends on both groundwater extraction and injection, existing 4-inch-diameter groundwater monitoring wells RW-4A, RW-5A, RW-8A, RW-11A, RW-15A, and RW-16A will be used as extraction wells. Well construction information indicates that these wells are screened between 4 to 22 ft bgs. Grundfos submersible pumps would be placed in the bottom of each of these wells (where the bulk of contamination exists) and operated on ‘run-dry’ logic control. Pump-test data will assist in determining final extraction rates; however, we are assuming that a 5- to 7-gallon-per-minute (gpm) extraction rate can be maintained during operation from the five extraction wells. A minimum of four HRWs (2-inch diameter polyvinyl chloride [PVC], ADS piping) will be installed in areas where elevated VOC concentrations have historically been reported, including within the Central Processing, Western (including Tank Farm Q), and Northern Areas (Figure 2), and immediately west of the northern section of the property and adjacent to well RW-11A (where SPH has been observed). This HRW will be located mostly within the boundary of the adjacent property to the west, and is important because well RW-11A has reportedly contained SPH and may be part of a commingled plume from off-site sources. Without this upgradient HRW it will be very difficult to remediate the RW-11 area. Prior to installation of this HRW, the land owner will be contacted and an access agreement for installation of the HRW will be prepared, reviewed and signed by the property owner.

The existing concrete pavement will be breached when concrete will be removed for installation of the vadose zone irrigation gallery (see Section 4.2) and utility piping. All concrete removal associated with trenching will be stockpiled on site, sampled for site constituents of concern and disposed of according to waste classi-

fication guidelines. The trenches will be backfilled with trench spoils or clean fill and capped with concrete to the existing grade in order to retain an impermeable surface.

The HRWs will be installed at approximately 10 to 15 ft bgs, within a soil zone of suitable permeability, and each well screen will be approximately 300 ft in length. In addition to the HRWs, existing vertical injection wells in the vicinity of RW-27A will be connected to the ISD™ system to continue to treat this area. It is anticipated that up to three existing vertical injection wells (IP-4, IP-22A, and IP-23A) may be connected to the ISD™ system.

Boring logs generated from the Additional Subsurface Evaluation discussed in Section 4.3.1 and geotechnical evaluation (discussed in Section 6.1 below) will also be reviewed to evaluate the best depth of HRW placement.

4.3.4.2. B-Zone

Existing wells EW-1B, RW-2B, RW-5B, RW-8B, RW-11B, RW-16B, RW-21B, and RW-22B will be used as extraction wells (NOTE: if RW-21B and RW-22B are not 4-inch-diameter wells, two additional 4-inch-diameter extraction wells will be installed). RW-16B is a 4-inch-diameter well; however, it is anticipated that this well will provide a sufficient extraction rate for treatment of groundwater impacts in the southwest corner of the site based on the limited and localized area of impacts being treated in this area. Grundfos submersible pumps would be placed in these wells and operated on 'run-dry' logic control. Pump test data will assist in determining final extraction rates; however, we are assuming that a 5- to 7-gpm extraction rate can be maintained during operation from six extraction wells screened from 30 to 60 ft bgs. The pumps will be placed at the bottom of these wells where the bulk of the contamination resides.

A minimum of 11 HRWs will be installed (2-inch-diameter PVC, ADS piping). The final depths and locations for the HRWs will not be decided until after the boring logs are reviewed from the environmental and geotechnical evaluations; however, we anticipate installing six HRWs at depths between approximately 30 to 40 ft bgs. The remaining five HRWs are anticipated to be installed between approximately 45 to 55 ft bgs. Each HRW screened interval will be approximately 300 ft in length. HRWs will be installed in areas where elevated VOC concentrations have historically been reported, including within the Northern and Central Processing Areas, and immediately west and off site of the Northern Area. As discussed in the A-zone section above, because the off-site HRW will be located mostly within the northern adjacent property, the land owner will be contacted and an access agreement for installation of the well will be prepared, reviewed and signed by the property owner prior to HRW installation.

A localized B-zone hot spot is present within the southwest corner of the site in the vicinity of well RW-16B, so we propose to install two injection wells to the north and northwest of RW-16B, which will be connected to the ISD™ system.

4.3.4.3. C-Zone

Several new C-zone injection wells will be installed within the Northern Area and potentially within the Tank Farm Q and Central Processing Areas. New C-zone injection wells will be located in areas where the heaviest VOC impacts are determined during the subsurface investigation, including several Northern Area locations due to the known VOC impacts in the vadose zone. All new C-zone injection wells installed will be connected to the ISD™ system.

In addition to the installing new C-zone wells for substrate injection, we will connect several of the existing site injection wells to the ISD™ system. These wells will include IP-59C, IP-60C and IP-61C (adjacent to monitoring well RW-10C), and injection wells IP-67C, 68C, 69C, 74C, and 75C (located at the northeastern

site boundary). No C-zone extraction wells will be installed due to the limited extent of significant impacts to C-zone groundwater, and prior to installing or converting any C-zone wells for groundwater remediation purposes, the US EPA will be contacted for approval.

4.3.4.4. Initial Extraction/Injection Well Selection Strategy

Because groundwater is more heavily impacted with SPH and dissolved-phase VOCs in specific site areas, only select extraction and injection wells will initially be utilized in order to avoid extracting and injecting (subsequent to treatment) high concentrations of VOC-impacted groundwater into less significantly impacted areas. Our plan includes the following.

- Relative to the A-zone, avoid 1) extracting groundwater from monitoring well RW-11A and 2) injecting VOC-impacted groundwater into the proposed HRW adjacent to monitoring well RW-12A.
- Relative to the B-zone, avoid 1) injecting VOC-impacted groundwater into the most westerly set of stacked HRWs located in the Central Processing Area between monitoring wells RP-15B and RW-22B and 2) extracting groundwater from monitoring wells RW-8B and RW-11B. Although RW-5B is heavily impacted with VOCs, extraction will be conducted in this well at a lower rate than other extraction wells in order to gain hydraulic control of the eastern section of the site.

There will be a contingency to add granular activated carbons (GAC) units to the ISD™ system if deemed necessary based on the rate of VOC biodegradation. Once significant dechlorination has been observed in the A- and B-zone areas described above, groundwater extraction will commence in these areas.

4.3.5. ISD™ Equipment Description

Two complete, integrated, full-scale remediation systems will be provided for the site. All equipment will be housed in a 7- by 9-foot enclosure complete with lighting and ventilation that will provide walk-in access to all equipment, including the following:

- a 100-gallon solution tank and integrated 10-gpm transfer pump;

- a 1,000-gallon holding tank with associated floats (external to system);
- a UL-certified PLC panel module;
- a 20-gpm ISD™ system with an integrated six-pump groundwater extraction system; the 20-gpm ISD™ system will be an automated, programmable, turnkey equipment platform that will utilize a 1-phase, 110/220V, 100-amp circuit power supply; and
- potentially adding two 1,000-lb GAC vessels to each of the ISD™ units (to be added if feasible at a later date).

The groundwater extraction system will initially extract water from five A-zone and six B-zone extraction wells and deliver it to the 1,000-gallon holding tank. Extraction wells RW-11A, RW-8B and RW-11B will be added to the extraction gallery once VOC concentrations have decreased in the Northern Area (both A- and B-zones) and southern portion of the Central Processing Area (B-zone only). The extracted groundwater will then be pumped (via transfer pump) through bag filters to remove total suspended solids (TSS) and into a solution mixing tank (1,000-gallon). The ISD™ system will pull water from the solution mixing tank and reinject it into the subsurface through an eight-station injection manifold that will be connected to the available injection wells (multiple injection wells may be tied to some stations). Every week, 100 to 200 pounds of treatment will be added to the solution tank for injection over time. This pulsed substrate/surfactant injection will minimize well fouling and support aggressive reductive dechlorination of chlorinated solvents and aerobic biodegradation of fuel-related compounds in the subsurface.

The ISD™ system will include a PLC module that will allow for ongoing adjustments regarding injection/extraction scenarios and alarm conditions. The PLC allows the user to control exact injection rates/times to each injection location, extraction rates and dwell/recharge times for each extraction well/pump, and numerous alarm conditions to prevent common failures (pump damage, internal leaks, fouling, etc.). The primary challenges for these treatment systems are mineral fouling and/or biomass fouling, which can negatively affect injection/extraction rates. In addition, because of the Bay

margin environment, there is also potential for high groundwater salinity concentrations to affect the treatment system infrastructure. In order to prevent mineral or biomass fouling, as well reduce equipment degradation because of salinity, we have contingency plans for each.

Mineral Fouling The first portion of groundwater remediation will involve enhanced dechlorination of chlorinated solvents, and will involve an anaerobic process. The ISD™ system operations during this treatment period will be creating reducing conditions that will prevent the oxidation of specific metals (iron and manganese) and harness others (calcium and magnesium), unlike an aerobic approach. The system will be constructed in a manner to minimize any introduction of oxygen into the recirculation loop. Drop-down piping, bulk heads, well-head connections, etc. are all built to prevent the entrainment of dissolved oxygen, which would cause metals and hardness to form precipitants to fall out of solution. Equipment and wells will be monitored weekly for indications of mineral fouling. If mineral fouling occurs during BTEX remediation, which will include an aerobic environment, we will have a contingency in place to clean well screens, pumps, and system components using diluted muriatic acid and/or sulfamic acid solutions to inhibit buildup of precipitants.

Biomass Fouling (Biofouling) This is the most common maintenance concern for these systems. Biomass will begin to buildup in the system components and extraction/injection wells over time. The majority of injection-well biofouling is avoided because the ISD™ system will inject the substrate on a pulsed delivery schedule to mitigate this growth (continuous substrate delivery will cause significant biofouling of the injection wells). Some biofouling will occur in the injection wells despite the pulsed substrate delivery. Pressure gauges for each injection location will be installed and monitored weekly to detect potential biofouling. Once the pressure reaches a certain point (typically 30 pounds per square inch (psi)), the wells will be rehabilitated by developing them with dilute hydrogen peroxide solution and surge blocks. The peroxide solution should mineralize all biomass within a 24-hour timeframe, and the injection

well will typically return back to baseline conditions. Biomass will also begin to grow in the system extraction wells once substrate breakthrough occurs. This occurs more slowly than the injection well biofouling. The extraction flow rates will be monitored for internal system pressures each week to observe any biofouling over time. If we observe a significant decrease in the extraction flow rate we will remove the pump and inject a dilute hydrogen peroxide solution into the well and allow it to sit overnight, mineralizing the biomass in the well screen and surrounding formation. The pump will also be submerged in a dilute peroxide solution and allowed to sit overnight, which thoroughly cleans the internal impellers. The system components will also be cleaned by flushing the system components with a dilute peroxide solution. This peroxide cleaning typically occurs about every 6 to 12 months (flow rate dependent).

Salinity The high-salinity groundwater environment will cause additional sulfate to be drawn into the treatment zone over time. Sulfate is a terminal electron acceptor that can compete with chlorinated solvents under reducing conditions. We have anticipated this in our substrate calculations/estimate to address the additional sulfate ‘sink’ for this project. We will also be monitoring for sulfate on a quarterly basis to evaluate this concern over time.

Salinity can also corrode equipment; the subsurface plumbing and equipment (including piping and injection/extraction pumps) will be composed of either stainless steel or PVC, which will inhibit corrosion. In addition, the above-ground tanks will be polyethylene, and the mixer impeller in the solution tank will be a combination of stainless steel (rod) and impeller (plastic). All other above-ground fittings will also be constructed of PVC.

4.3.6. Treatment Substrate Selection and BTEX Amendments

Regarding ERD treatment of chlorinated solvents, necessary electron donor substrate characteristics include high-water solubility and a low retardation factor in order to ensure mobility within the target treatment zone. If the substrate has a low solubility or

significant retardation factor, then delivery via induced hydraulic gradients would require multiple pore volumes of recirculation prior to achieving site-wide delivery. In addition, the substrate needs to be affordable enough to allow for purchase of an appropriate mass that can provide the required degree of de-halogenation. In order to achieve optimal results, we will be using a nutrient-amended carbohydrate substrate produced by ETEC (CarBstrate™). This product has a high solubility level and has a low retardation factor, and is also a non-toxic, food-grade product that includes the macro-nutrients that will be necessary for effective microbial growth (i.e. nitrogen and phosphates), as well as a specific suite of trace metals that have been shown to be critical for active anaerobic microbial activity. It is also a dry substrate, which helps prevent fouling of injection points and equipment components.

Once we have seen a 95% mass reduction in chlorinated solvent compounds in both soil and groundwater, and have seen asymptotic concentrations of chlorinated solvents in site groundwater and vadose zone pore water, the US EPA will be petitioned in order to cease active treatment of chlorinated solvents and begin rebound assessment monitoring. Once the rebound assessment monitoring data indicates that there are no chlorinated solvent concentration spikes in groundwater, the US EPA will be petitioned a second time in order to begin active treatment of BTEX compounds in each media. Active treatment of BTEX compounds will not begin until the US EPA approves active BTEX treatment. The US EPA will be petitioned a third time for permission to cease active treatment of BTEX compounds and begin rebound assessment monitoring. If the rebound assessment monitoring for BTEX compounds shows that the concentrations are stable, the US EPA will be petitioned a fourth time for permission to begin MNA for both chlorinated solvents and BTEX compounds.

The proposed BTEX remediation process will utilize the existing system and infrastructure to deliver electron acceptors (nitrate, sulfate, etc.), macronutrients (nitrogen and phosphorous), bacterial amendments, and biosurfactants to facilitate the biodegradation of BTEX compounds. ETEC's total petroleum hydrocarbon (TPH) Bacterial Consor-

tium (EZT-A2TM), PetroSolvTM surfactant, and CBNTM nutrient mix will be used. The EZT-A2TM is a concentrated liquid enhancement consisting of pre-acclimated, hydrocarbon-degrading bacteria that maximize microbial growth and activity in the subsurface. The PetroSolv is a liquid (concentrated) non-ionic, biodegradable surfactant that desorbs the BTEX contamination from the soil matrix, making these compounds amenable to biodegradation. The CBNTM nutrient mix is a dry, granular, fully-soluble product that contains secondary electron acceptors (nitrate and sulfate), macro-nutrients, and micro-nutrients specially blended for in-situ bioremediation. The PLC of the system will be used to strategically deliver these amendments to the BTEX-impacted areas only.

4.3.7. Pump and Injection Testing

A pump and injection pilot test will be conducted on site to evaluate hydraulic parameters in relationship to groundwater extraction and injection. The groundwater injection/extraction data resulting from the tests and radius of influence (ROI) will be used to determine the optimal ISDTM injection and extraction rates.

4.3.7.1. Pump Test

A constant-rate pumping test will be conducted on several wells on site to evaluate hydraulic parameters in the A-and B-zone aquifers. The proposed wells for the pump tests are extraction wells RW-4A and RW-21B, and RW-8A and RW-8B. Since no extraction wells will be installed within the C-zone, no pump test will be performed for that aquifer. The pump tests will include groundwater extraction at a constant rate, and recording the drawdown of the control well and observation wells within the ROI of the control well. The goal of a constant-rate pumping test is to estimate hydraulic parameters of aquifers. Once these parameters are established, the extraction rate for the ISDTM system can be established.

Groundwater extracted from site monitoring wells will be pumped into a holding tank where it will remain until it can be discharged into the ISD™ system and reinjected into the subsurface after treatment.

4.3.7.2. Groundwater Injection Test

A review of historical site information, including injection data and boring logs, was conducted to evaluate soil permeability within the site aquifers. The information indicated subsurface materials between the surface (A-zone) and C-zone aquifers will allow for groundwater recirculation using the proposed treatment system. However, in order to evaluate the optimal flow rate for the treated groundwater, an injection test is necessary for the site. The injection test will consist of injecting water under pressure into an existing site well from a water tank and increasing the injection pressure until a stable flow rate of 2 to 3 gpm is achieved. Perimeter wells will be monitored for change in elevation to evaluate the ROI from the injection. The injection test and well elevation monitoring will be conducted during a three-day period until an injection pressure of 10 to 15 psi is achieved along with the stable flow rate of 2 to 3 gpm. Wells being considered for the injection tests include: 1) proposed A-zone vertical injection well IP-70A (adjacent to proposed extraction well RW-4A); 2) proposed vertical injection well IP-51B (adjacent to RW-8B) and; 3) two C-zone injection wells, one of which is included in the cluster of injection wells located along the eastern site boundary and the other of which is located within a cluster of injection wells in the Central Processing Area. Water used for the injection testing will come from an above-ground water source.

4.3.7.3. Tracer Test

The injection/extraction test will be modified in a manner that will provide additional information regarding solute transport in the target saturated zones. A simple sodium bromide solution will be added to the recirculation loop to obtain the de-

sired information (breakthrough time, concentration, etc.). This test will likely be conducted within those injection and extraction wells discussed above.

4.3.8. Implementing Current Enhanced Reductive Dechlorination Injection Program

The enhanced biological treatment currently used on site will be continued through the transition period prior to implementing the remedial alternative discussed in this CRDP. The future injection schedule will follow the current schedule until the ISD™ system is operational.

5. REMOVAL OF SUBSURFACE FEATURES

Two subsurface features, a deep sump and septic tank, will to be removed, backfilled and capped on site. We understand that the septic system has dimensions of 12 ft by 20 ft by 6 ft and the deep sump has dimensions of 10 ft by 10 ft by 6 ft. We also understand that the septic tank is partially composed of a redwood interior. Septic and deep sump removal activities will include sludge removal, demolition of the septic and sump interiors, backfilling with clean fill and capping with concrete to match the existing grade. All materials (with the exception of soil) removed during demolition activities will be tested for waste classification and transported to the appropriate waste disposal facility. Any soil removed from these areas during deep sump and septic removal will be returned to the pits, and the pits will ultimately be capped with concrete slab to grade.

6. SITE COVER

This section discusses the design and construction of the site cover. The purpose of the site cover is to provide a physical barrier to prevent direct contact with contaminated media beneath it. The site cover will also raise the ground elevation above the flood plain which will benefit future development. All key documents relating to the newly-designed site cover will be presented to the US EPA for review and approval prior to implementation.

6.1. Geotechnical Evaluation

A geotechnical evaluation will be conducted to characterize subsurface conditions to provide recommendations for the design and construction of the site cover. The geotechnical evaluation will be conducted prior to site cover construction. Boring logs from the geotechnical investigation will also provide additional lithologic information, which will be used to assist in the evaluation of HRW placement. Additional geotechnical consulting services will be provided for earthwork observation and compaction testing, to further evaluate the geotechnical conditions for consistency with design assumptions and to check the interpretation and implementation of geotechnical recommendations relating to the site cover.

The geotechnical evaluation will include subsurface exploration to evaluate subsurface conditions. The evaluation will consist of several exploratory borings, which will be advanced using a hollow-stem auger rig to depths of approximately 25, 50, and 70 ft below the existing grade. In addition to the exploratory borings, cone penetration test (CPT) soundings will be performed to similar depths. The actual depth of exploration will be influenced by the subsurface conditions encountered and the presence of fill material. Subsurface conditions will be logged by a field engineer or geologist, and bulk and relatively undisturbed soil samples will be collected for laboratory testing. The borings and soundings will be backfilled with Portland cement grout in compliance with the San Mateo County Environmental Health District (SMCEHD) drilling permit, and pavement will be patched to match the existing grade. Soil cuttings will be collected in 55-gallon drums or bins and temporarily stored on site for a period of up to 4 weeks before being disposed of off site. Analytical testing will be performed on the collected cuttings, as needed, to characterize the waste for disposal.

Subsequent to sample collection, select soil samples will be analyzed for the following parameters: soil moisture and dry density; percentage of soil particles finer than the No. 200 sieve; Atterberg limits; soil corrosivity; expansion index; R-value; consolidation characteristics; and unconfined compressive strength, as appropriate.

Field and laboratory data will be reviewed and compiled into a Geotechnical report, which will include the following information.

- An evaluation of how to mitigate potential drainage on the existing concrete slab toward various low points on site will be included within the Geotechnical Evaluation report.
- Subsurface conditions encountered at the site including stratigraphy, depth to groundwater if encountered, and published historic groundwater depth.
- Geologic and seismic hazards present on site including potential for liquefaction, corrosion, and settlement.
- Suitability of the site cover from a geotechnical standpoint in light of the potential seismic and geologic hazards.
- Earthwork and compaction requirements, including subgrade preparation, underground utility installation, and suitability of the on-site soil for subgrade and use as fill material.
- Recommendations for measures to mitigate the effect of the relevant geologic and seismic hazards on the proposed site cover, as appropriate.
- Lateral earth pressures for retaining wall design, if necessary.
- Consolidation settlement and surcharging program.
- Soil type and seismic coefficients for seismic design conforming to the 2010 California Building Code.
- Findings and conclusions from our evaluation.

6.2. Site Cover Design and Installation

Construction of the site cover above the existing concrete surface will prevent direct contact with contaminated subsurface media.

The site cover design will include a minimum 3-foot thick soil layer composed of clean engineered fill material and a hardscape material (asphalt or concrete). All fill materials will be analyzed for site-specific environmental and geotechnical parameters prior to import, and will be compacted to relative compaction per the geotechnical engineering specifications.

In addition, since installation of the site cover includes raising the surface elevation, a new storm water management system will be designed to collect, store, sample and discharge storm water collecting on 1) the existing concrete slab beneath the site cover, and 2) on top

of the site cover hardscape material (asphalt and concrete). Storm water monitoring, sample collection, and discharge will be regulated under an updated National Pollution Discharge Elimination System (NPDES) industrial permit. Long-term monitoring and repair of the site cover will be performed in accordance with the O&M Plan.

7. RISK MANAGEMENT PLAN AND SITE-SPECIFIC HEALTH AND SAFETY PLAN

A site-specific Risk Management Plan (RMP) will be prepared as part of the CMIPP and will be used to manage risks posed by existing site contaminants in a manner that is protective of human health and the environment. It will also be used as a guide during any future development activities. The RMP will include the following.

- A background discussion of soil and groundwater conditions on site.
- Planning and implementation of risk management measures prior to and during development. This would include identifying activities in site areas that may impact human health, preparation and implementation of dust and vapor control plans to mitigate dust and vapors during all site construction activities (including, but not limited to, contaminated concrete slab and shallow soil removal during installation of the irrigation and a-zone well piping). Other risk management measures would include requirements for removing subsurface features (sump and septic tank), specifications for materials and thickness of the site cover, soil and soil stockpile management protocols, soil and construction debris disposal guidance, contractor and consultant health and safety plan protocols, and reporting guidelines.
- Post-development risk management measures, including a discussion of institutional and engineering controls relating to long-term risk management. This will include a discussion of preparation and implementation of a Soil Vapor Mitigation Plan (SVMP) for vapor intrusion protection inside the proposed site buildings. The SVMP will include design documents and specifications for construction of a SVMS for each building on site. A brief summary of the SVMS is below.

A separate site-specific Health and Safety Plan (HSP) will be prepared by the consultant and contractor prior to any field activities conducted on site. The HSP shall include the following information:

- site description, scope of work and organization and responsibilities;

- an evaluation of site hazards including noise, field equipment, slips and falls, lifting techniques, solar radiation, underground and above-ground utilities, and site constituents of concern;
- procedures for equipment decontamination;
- medical surveillance, hazards monitoring and employee training requirements, and emergency response;
- confined space entry; and
- a figure and description of the best route to the nearest medical center for emergency treatment.

All field staff will attend tailgate meetings prior commencement of field activities, and will sign the *On-site Working Personnel Sign-In* sheet indicating that they have 40-hour HAZWOPER training with current refresher status and have read and understood this Health and Safety plan, and agree to abide by its provisions. Site visitors will also review the HSP and sign as well.

8. SOIL VAPOR MITIGATION SYSTEMS

In order to protect against the potential for vapor intrusion into the indoor air space of future site buildings, SVMSs will be constructed beneath the building concrete slabs.

Following installation of the building foundations (footings and grade beams) and subsurface utilities within the building footprints, SVMSs will be installed prior to pouring the concrete floor slabs. The SVMSs will include vapor barriers and sub-slab ventilation systems installed within the building footprints. The vapor barriers and sub-slab ventilation systems will be designed in accordance with the guidelines of Department of Toxic and Substances Control (DTSC) October 2011 Vapor Intrusion Mitigation Advisory (VIMA). The SVMSs will be designed and installed as passive systems that may be converted to active systems if necessary based on future vapor monitoring data. The installation and inspection of SVMSs would be performed as discussed below.

8.1. Sub-Slab Ventilation System Installation

Prior to installation of vapor barrier membranes, components of a sub-slab ventilation system will be installed. The sub-slab ventilation system will be composed of horizontal ventilation lines, which are connected to solid-wall PVC piping for transitions across building slabs/footings/grade beams and at vertical ventilation riser locations. The sub-slab ventilation lines will be set in a 6-inch-thick gravel layer and vertical ventilation risers will be installed within wall cavities and will extend at least 1-foot above the roof line. The top of the cast vertical ventilation risers will be completed with a non-restricting vent cap to prevent rain from entering the venting system. A vapor sampling port and access panel will be installed near the base of the vertical ventilation riser for future vapor monitoring.

8.2. Vapor Barrier Membrane System Installation

The vapor barrier membrane will be installed over the sub-slab ventilation lines and gravel layer. The vapor barrier membrane will consist of a geo-synthetic base layer, a 60-mil spray-applied membrane, and a protective geo-synthetic cover layer. All penetrations through the membrane system will be sealed in accordance with the manufacturer's specifications.

8.3. Installation Oversight and Inspection

Oversight and inspections will be performed during installation of the sub-slab ventilation systems and vapor barrier membranes. The inspector will be certified by the vapor barrier manufacturer to perform the required inspection activities.

8.4. Utility Conduit Seals

All vertical electrical conduits, which penetrate the vapor barrier membrane, will be sealed at the terminations of the conduits to reduce the potential for vapor migration through conduits into buildings. The conduit seals will be made of an inert gas-impermeable material, extending a minimum of 6-conduit diameters, or 6 inches, which ever is greater, into the conduit.

8.5. Utility Trench Dams

Utility trench dams will be constructed in all utility trenches that extend beneath the building foundation from areas outside the perimeter of the building to reduce the potential for vapor migration through the relatively permeable trench backfill. The utility trench dam will be installed immediately adjacent to the exterior perimeter of the building foundation. The trench dam will consist of a 3-foot continuous length of cement slurry and will extend at least six inches above the bottom of the perimeter footing to the base of the trench.

8.6. Soil Vapor Mitigation System Operations & Maintenance Plan

A SVMS O&M Plan will be prepared and implemented for the site. The SVMS O&M Plan will present general information and protocols for monitoring, data acquisition, performance evaluation, and reporting activities associated with the vapor barriers and sub-slab ventilation systems. The SVMS O&M Plan will be prepared in accordance with the guidelines of DTSC's October 2011 VIMA.

9. DESIGN STRATEGY AND BASIS

Our overall design strategy and basis for the installation and operation of the ISD™ system is to effectively and efficiently remediate site VOC impacts to both soil and groundwater. In addition, the ISD™ system will maintain a high degree of hydraulic control/capture, transportability and connectivity in the saturated zone(s) during active treatment to prevent further off-site migration of the VOC plume.

Our goals are to 1) achieve a 95% reduction in total mass of VOCs within 4 years in vadose zone soils and site groundwater within the A-, B-, and C-zone aquifers, 2) meet the RBTCs for soils per Table 5 of the Final Draft, CSAP, dated March 2011 (Iris, 2011), and 3) meet the Groundwater Cleanup Objectives (GCOs) for groundwater contained in US EPA's July 2008 Remedy. As cleanup objectives for groundwater are approached, the US EPA may be petitioned for approval to cease active treatment and begin MNA.

A different substrate will be used for the groundwater remediation of chlorinated solvents and BTEX compounds. In order to assess the enhanced reductive dechlorination of chlorinated sol-

vents and biodegradation of BTEX compounds, as well as potential rebound of VOCs, MNA will be conducted until VOCs stabilize within established remediation goals. The rebound assessment will include temporal figures showing historical/baseline groundwater concentrations, groundwater concentrations during treatment, and groundwater concentrations for one year after the systems are inactivated. Rebound will be assessed by comparing post-shutdown groundwater concentrations with baseline groundwater concentrations. These will be expressed in 'percent rebound' values (i.e. post-shutdown groundwater concentrations divided by baseline groundwater concentrations X 100). Once VOC concentrations remain asymptotic within the remediation goals, several site groundwater monitoring wells may be decommissioned pending approval of the US EPA.

10. SOIL VAPOR, GROUNDWATER AND SURFACE-WATER MONITORING PROGRAM

10.1. Soil Vapor Monitoring

Soil-vapor generation relating to the existing site VOCs, and methane generated during the remediation process is likely due to the elevated concentrations of VOCs in site soil and groundwater. The off-site migration of soil vapor is also a possibility because of the extent of soil and groundwater impacts on site. In order to monitor potential vapor migration toward the commercial and industrial properties south and west of the site, two soil vapor wells will be installed along the southern boundary and four soil vapor wells will be installed along the western site boundary. Soil vapor samples will be collected per regulatory (US EPA/DTSC) guidelines, which will include collecting samples on a quarterly basis. Samples will be collected in Summa canisters and analyzed for VOCs using US EPA Method TO-15 and methane using ASTM Method 1946.

In the case that methane concentrations are detected above applicable screening levels in the border wells, the substrate concentrations and delivery can be adjusted to reduce methanogenic conditions. In addition, sulfate from the extraction wells will likely help maintain sulfate-reducing conditions, which also prevents the creation of highly methanogenic condi-

tions. Methane also does not readily migrate in a lateral direction, preferring to migrate vertically due to barometric pressure fluctuations and tidal effects on groundwater elevations at the site. Soil gas containing VOCs appears to be a bigger issue; however, this should be controlled by containing the VOC-impacted groundwater plume close to the site boundaries via groundwater circulation.

In the event that soil vapors migrate either toward the west or south, we will provide a contingency plan in the CMIPP to mitigate the potential off-site migration of soil gas and/or methane.

10.2. Groundwater Monitoring

Once our ISD™ system has been implemented, groundwater monitoring will be conducted on a quarterly, semi-annual and annual basis for 30 years from several existing and future groundwater monitoring, extraction and injection wells on and off site. In addition to the existing groundwater monitoring schedule, groundwater monitoring will be conducted on 13 vadose zone, five A-zone, six B-Zone, and two C-Zone wells on a monthly basis for the first quarter (and a quarterly basis subsequent to the first quarter) to evaluate a full range of VOCs and inorganic compounds (e.g., ammonia, nitrate/nitrite, sulfate, phosphate, dissolved iron, dissolved manganese), methane/ethene/ethane, and TOC due to the presumed rapid initial change in groundwater quality and parent chlorinated solvent concentrations. In addition, we will continue to monitor for the same parameters (DO, ORP, and pH), and sample for VOCs in the existing wells (or in wells that may replace these existing wells) that are currently sampled by Arcadis. This will allow us to provide other lines of evidence to show biological activity in the saturated zones. We will provide a tabular list of all wells and the associated analytical parameters in the CMIPP.

The schedule for collecting groundwater quality parameter (i.e. DO, ORP, and pH) data will be monthly/quarterly O&M events. We also propose to install and monitor up to 20 new injection/monitoring wells, and we will continue to monitor a portion of the 70-plus injection

wells historically used for injecting the current bio-augmentation compound (molasses and cheese whey).

Prior to implementing a monitoring program for the newly-installed groundwater monitoring wells (which will be included in the CMIPP), baseline groundwater sampling analysis will be conducted and will include the full range of VOCs, inorganic compounds, and groundwater quality parameters.

The groundwater monitoring plan will be implemented upon approval of the CMIPP. The groundwater monitoring program and groundwater data will be evaluated on an annual basis to determine if any changes to the sampling program or schedule will be necessary. Groundwater samples submitted for laboratory analysis will be analyzed using a National Environmental Laboratory Accreditation Program (NELAP)-certified laboratory, and instrumentation used for measurement of groundwater parameters (i.e. DO, ORP, and pH) will be calibrated according to equipment specifications prior to measurements.

10.3. Surface Water Monitoring

Surface-water sampling will continue to be conducted on a quarterly basis from four sample locations in the northern and eastern ROSP sloughs adjacent to the site. Samples will be analyzed for VOCs using US EPA Method 8260B.

10.4. Semi-Annual Groundwater and Surface Water Sampling Reports

Semi-annual groundwater and surface-water monitoring reports will be prepared based on data collected during the sampling events. The reports will present background site information, groundwater measurements, sampling methodologies, purge and groundwater parameter information and data, tabular groundwater data, and figures showing VOC iso-concentration contour maps and groundwater elevation contour maps in each of the groundwater zones. Graphs will also be included in an appendix illustrating groundwater remediation performance monitoring results versus time for select wells.

10.5. Reconstruction, New Construction and Decommissioning of Site Wells

Subsequent to the installation of 20 additional groundwater monitoring wells, the total number of monitoring wells on site will be 78. There are also more than 70 injection wells historically used for injecting the current bio-augmentation compound. We anticipate that several of these wells will be decommissioned or moved during site construction activities, in particularly during the construction of the site cover; however, this will not occur until after a review and assessment of monitoring well data has been completed and a formal request to decommission select wells has been submitted to the US EPA for approval.

Those wells to be decommissioned and/or replaced will be done so following SMCEHD and the State of California Department of Water Resources (DWR) well decommissioning guidelines. Options for decommissioning wells under permit guidelines include pressure grouting from the surface and over-drilling the top 5 ft or over-drilling the entire segment of the well to the bottom if any section of the well is screened more than 25 ft. Ninyo & Moore will review well construction reports from either the SMCEHD or DWR to evaluate the screen length of the wells to be decommissioned. Well decommission permits will be obtained prior to well decommission activities, and well closure documentation will be submitted to both the SMCEHD and DWR.

Because the site will be raised in elevation after the site cover is installed, all of the existing site wells to be utilized for future groundwater monitoring events will be raised prior to construction of the site cover, and protected during site cover construction.

11. ASSUMPTIONS

The tasks discussed within this CRDP are directly related to those outlined in the site Remedy, the Request for Corrective Measures Implementation Program Plan (US EPA 2013A), and the June and September JA Comments on Conceptual Remedial Design Plan (US EPA, 2013b and 2013c).

The number of new groundwater monitoring wells to be constructed, monitoring and injection wells to be decommissioned, and wells to be modified (increased in height) to mount flush with the new surface elevation subsequent to site cover construction are approximate at this time and will be refined upon completion of the CMIPP.

12. COST ESTIMATE FOR REMEDY DESIGN, IMPLEMENTATION, AND OPERATION AND MAINTENANCE

A remediation cost estimate for the ISD™ system is included in Table 1 and a breakdown of remediation costs on a quarterly schedule for 30 years is included in Table 2.

13. REFERENCES

- Arcadis, First and Second Quarter 2013 Semiannual Report, Former Romic Environmental Technologies Corporation, 2081 Bay Road, East Palo Alto, California, dated August 16.
- Iris Environmental, 2011 Final Site-Wide Sampling and Analysis Plan, Former Romic Environmental Technologies Corporation Facility, 2081 Bay Road, East Palo Alto, California, dated March 30
- Iris Environmental, 2013 Revised Comprehensive Site-Wide Sampling and Analysis Program Report, Former Romic Environmental Technologies Corporation Facility, 2081 Bay Road, East Palo Alto, California, dated June 12.
- Joint Agency Comments on 2013 Conceptual Remedial Design Plan, Former Facility Technologies Corporation (Romic) Site, East Palo Alto, California, dated June 6.
- Joint Agency Comments on the 2013 Conceptual Remedial Design Plan, Former Romic Environmental Facility, East Palo Alto, California, dated September 13.
- U.S. Environmental Protection Agency Office of Solid Waste and Emergency Response, 1998 Evaluation of Subsurface Engineered Barriers at Waste Sites, dated July.
- U.S. Environmental Protection Agency, Region 9, 2008 Final Remedy Decision for Former Romic Environmental Technologies Corporation Facility, East Palo Alto, California, ID# AD009452657, dated July
- U.S. Environmental Protection Agency, 2013 Request for Corrective Measures Implementation Program Plan prepared by the US EPA, dated April 26

TABLE 1 - COST SCHEDULE				
SUBSURFACE CHARACTERIZATION				
Subtotal				\$ 65,176
DRAFT and FINAL CMIP (including risk assessment, public participation plan, and HASP)				
Subtotal				\$ 45,910
CONTINUE CURRENT INJECTION REMEDY (8 quarterly injection event)				
Subtotal				\$ 176,000
EXISTING CAP O&M (initial repairs, 2 inspections/year and 1 discharging event/year for 3-years)				
Ninyo & Moore Costs				\$ 17,344
Concrete Surface Repair	1 event	@ \$	16,000.00 /event	\$ 16,000
Rainwater sampling and discharge	3 events	@ \$	15,000.00 /event	\$ 45,000
Maintenance and Repairs	3 events	@ \$	3,600.00 /event	\$ 10,800
Subtotal				\$ 89,144
SPH SKIMMING/DISPOSAL (2 months of skimming, weekly visits, and removal of 20,000 gallons of product)				
Ninyo & Moore Costs				\$ 21,312
Skimming Equipment				\$ 15,000
Holding Tank	2 mo	@ \$	1,500.00 /mo	\$ 3,000
Product Disposal	20,000 gallons	@ \$	2.00 gallon	\$ 40,000
Subtotal				\$ 79,312
GROUNDWATER EXTRACTION/INJECTION PILOT TESTING				
Ninyo & Moore Costs				\$ 6,816
Drillers	4 days	@ \$	2,600.00 /day	\$ 10,400
Holding tank for containing extracted ground water	2 mo	@ \$	1,000.00 /mo	\$ 2,000
Subtotal				\$ 19,216
FULL-SCALE IN-SITU DELIVERY TREATMENT SYSTEM INSTALLATION				
Ninyo & Moore Costs				\$ 66,210
Remediation Contractor Costs				\$ 900,000
Horizontal Well Driller Costs				\$ 750,000
Trenching and Drilling Spoils Disposal Costs				\$ 58,000
Subtotal				\$ 1,774,210
FULL-SCALE IN-SITU DELIVERY TREATMENT OPTION O&M FOR 4 YEARS				
Ninyo & Moore Costs				\$ 213,400
O&M Outside Costs (monthly O&M, electricity, GAC vessels rental/change outs for 1 year)				\$ 193,200
REMOVAL OF SUBSURFACE FEATURES (Deep Sump and Septic Tank)				
Subtotal				\$ 84,848
WELL RAISING (up to 100 wells to be raised)				
Subtotal				\$ 93,730
GROUNDWATER MONITORING/INJECTION WELL INSTALLATION (up to 20 wells)				
Ninyo & Moore Costs				\$ 39,675
Driller	1360 ft	@ \$	70.00 /ft	\$ 95,200
IDW	50 tons	@ \$	215.00 /ton	\$ 12,363
Subtotal				\$ 147,238
ISD, AND WELL INSTALLATION REPORT (including revised groundwater monitoring plan)				
Subtotal				\$ 17,616
QUARTERLY GROUNDWATER MONITORING (25 wells for 30 years)				
Ninyo & Moore Costs				\$ 757,600
Lab Analysis Costs				\$ 472,650
Subtotal				\$ 1,230,250
SEMIANNUAL GROUNDWATER MONITORING (10 wells for 30 years)				
Ninyo & Moore Costs				\$ 139,680
Lab Analysis Costs				\$ 53,130
Subtotal				\$ 192,810

ANNUAL GROUNDWATER MONITORING (13 wells for 30 years)			
Subtotal			\$ 118,255
QUARTERLY SURFACE WATER MONITORING (4 sampling points for 30 years)			
Subtotal			\$ 133,205
SEMI-ANNUAL GROUNDWATER REPORTING (for 30 years)			
Subtotal			\$ 583,120
SOIL VAPOR MONITORING WELL INSTALLATION (up to 6 soil vapor wells)			
Subtotal			\$ 8,697
SOIL VAPOR MONITORING/REPORTING (quarterly for 1 year, semi-annual for 3 years, and annual for 10 years)			
Subtotal			\$ 94,520
5-YEAR REMEDY PERFORMANCE REPORTS (for 30 years)			
Subtotal			\$ 38,130
PROGRESS REPORTS, MEETINGS, PUBLIC PARTICIPATION, AND CORRESPONDENCE (for 30 years)			
Subtotal			\$ 442,320
WELL DESTRUCTION AND REPORTING (abandoning up to 120 injection/monitoring wells and all HRWs)			
Ninyo & Moore Costs			\$ 69,960
Drillers			\$ 206,736
IDW	70 tons	@ \$ 215.00 /ton	\$ 17,308
Subtotal			\$ 294,003
TOTAL ESTIMATED COSTS (Non-Development Related)			
			\$ 6,134,310

TABLE 2 - QUARTERLY PROJECT COST BREAKDOWN AND PROJECT SCHEDULE

YEAR	1				2				3-5		3-4	5	6-29	6-29	6-29	10, 15, 20, 25	30
TASK	Q1	Q2	Q3	Q4	Q5	Q6	Q7	Q8	Q9, Q11, Q13, Q15, Q17, Q19	Q10, Q14, Q18	Q12, Q16	Q20	Q21, Q23, Q25, Q27, Q29, Q31, Q33, Q35, Q37, Q39, Q41, Q43, Q45, Q47, Q49, Q51, Q53, Q55, Q57, Q59, Q61, Q63, Q65, Q67, Q69, Q71, Q73, Q75, Q77, Q79, Q81, Q83, Q85, Q87, Q89, Q91, Q93, Q95, Q97, Q99, Q101, Q103, Q105, Q107, Q109, Q111, Q113, Q115, Q117, Q119	Q22, Q26, Q30, Q34, Q38, Q42, Q46, Q50, Q54, Q58, Q62, Q66, Q70, Q74, Q78, Q82, Q86, Q90, Q94, Q98, Q102, Q106, Q110, Q114, Q118	Q24, Q28, Q32, Q36, Q44, Q48, Q52, Q56, Q64, Q68, Q72, Q76, Q84, Q88, Q92, Q96, Q104, Q108, Q112, Q116	Q40, Q60, Q80, Q100	Q120
Subsurface Characterization	\$ 65,000.00																
Draft and Final Corrective Measures Implementation Plan, Implementation of the Plan, Human Health Risk Assessment, Public Participation and Health & Safety Plan	\$ 45,910.00																
Continuance of Current Injection Remedy	\$ 22,000.00	\$ 22,000.00	\$ 22,000.00	\$ 22,000.00	\$ 22,000.00	\$ 22,000.00	\$ 22,000.00	\$ 22,000.00									
Existing Cap Operation and Maintenance, including initial repairs, semi-annual inspections, and storm water discharge annually for three years	\$ 51,816.00				\$ 18,600.00			\$ 18,600.00									
Separate Phase Hydrocarbon (SPH) skimming and disposal. Includes two months of skimming, approximately 20,000 gallons of SPH removal and disposal.	\$ 79,312.00																
Groundwater Extraction/Injection Pilot Testing	\$ 19,216.00																
Full Scale In-Situ Delivery (ISD) Treatment System and Infiltration Gallery Installation	\$ 1,774,210.00																
Full Scale ISD Treatment Option O & M, including O&M, electricity, and granular activates carbon change-outs for one year.	\$ 24,600.00	\$ 24,600.00	\$ 24,600.00	\$ 24,600.00	\$ 24,600.00	\$ 24,600.00	\$ 24,600.00	\$ 24,600.00	\$ 19,362.67	\$ 19,362.67	\$ 29,044.00						
Removal of Subsurface Features (Septic Tank and Deep Sump)	\$ 84,848.00																
Well Raising (up to 100 wells)	\$ 46,865.00	\$ 46,865.00															
Groundwater Monitoring/Injection Well Installation	\$ 73,619.00	\$ 73,619.00															
ISD and Well Installation Report (Including Revised Groundwater Monitoring Plan)		\$ 17,616.00															
Quarterly Groundwater Monitoring (25 wells for 30 years)	\$ 10,260.00	\$ 10,260.00	\$ 10,260.00	\$ 10,260.00	\$ 10,260.00	\$ 10,260.00	\$ 10,260.00	\$ 10,260.00	\$ 10,260.00	\$ 10,260.00	\$ 10,260.00	\$ 10,260.00	\$ 10,260.00	\$ 10,260.00	\$ 10,260.00	\$ 10,260.00	\$ 10,260.00
Semi-Annual Groundwater Monitoring (10 Wells for 30 Years)		\$ 3,220.00		\$ 3,220.00		\$ 3,220.00		\$ 3,220.00		\$ 3,220.00	\$ 3,220.00	\$ 3,220.00		\$ 3,220.00	\$ 3,220.00	\$ 3,220.00	\$ 3,220.00
Annual Groundwater Monitoring (13 wells for 30 years)				\$ 3,942.00				\$ 3,942.00			\$ 3,942.00				\$ 3,942.00		
Quarterly Surface Water Monitoring (4 wells for 30 years)	\$ 1,110.00	\$ 1,110.00	\$ 1,110.00	\$ 1,110.00	\$ 1,110.00	\$ 1,110.00	\$ 1,110.00	\$ 1,110.00	\$ 1,110.00	\$ 1,110.00	\$ 1,110.00	\$ 1,110.00	\$ 1,110.00	\$ 1,110.00	\$ 1,110.00	\$ 1,110.00	\$ 1,110.00
Semi-Annual Groundwater Reporting (30 years)	\$ 9,730.00		\$ 9,730.00		\$ 9,730.00		\$ 9,730.00		\$ 9,730.00		\$ 9,730.00		\$ 9,730.00		\$ 9,730.00		\$ 9,730.00
Soil Vapor Monitoring Well Installation (6 soil vapor wells)								\$ 8,697.00									
Soil Vapor Monitoring and Reporting (10 years)								\$ 4,726.00	\$ 4,726.00	\$ 1,575.33			\$ 1,134.24				
5-Year Remedy Performance Evaluation Reports (30 years)												\$ 6,000.00				\$ 6,000.00	\$ 6,000.00
Progress Reports, Meetings, Public Participation (30 years)	\$ 3,700.00	\$ 3,700.00	\$ 3,700.00	\$ 3,700.00	\$ 3,700.00	\$ 3,700.00	\$ 3,700.00	\$ 3,700.00	\$ 3,700.00	\$ 3,700.00	\$ 3,700.00	\$ 3,700.00	\$ 3,700.00	\$ 3,700.00	\$ 3,700.00	\$ 3,700.00	\$ 3,700.00
Well Destruction and Reporting				\$ 73,500.00				\$ 73,500.00			\$ 36,750.00	\$ 73,500.00					
Quarter Totals	\$ 2,312,196.00	\$ 202,990.00	\$ 71,400.00	\$ 142,332.00	\$ 90,000.00	\$ 64,890.00	\$ 71,400.00	\$ 174,355.00	\$ 293,332.00	\$ 117,684.00	\$ 176,052.00	\$ 97,790.00	\$ 1,296,712.00	\$ 457,250.00	\$ 444,640.00	\$ 97,160.00	\$ 24,290.00

Total All Quarters \$ 6,134,473.00

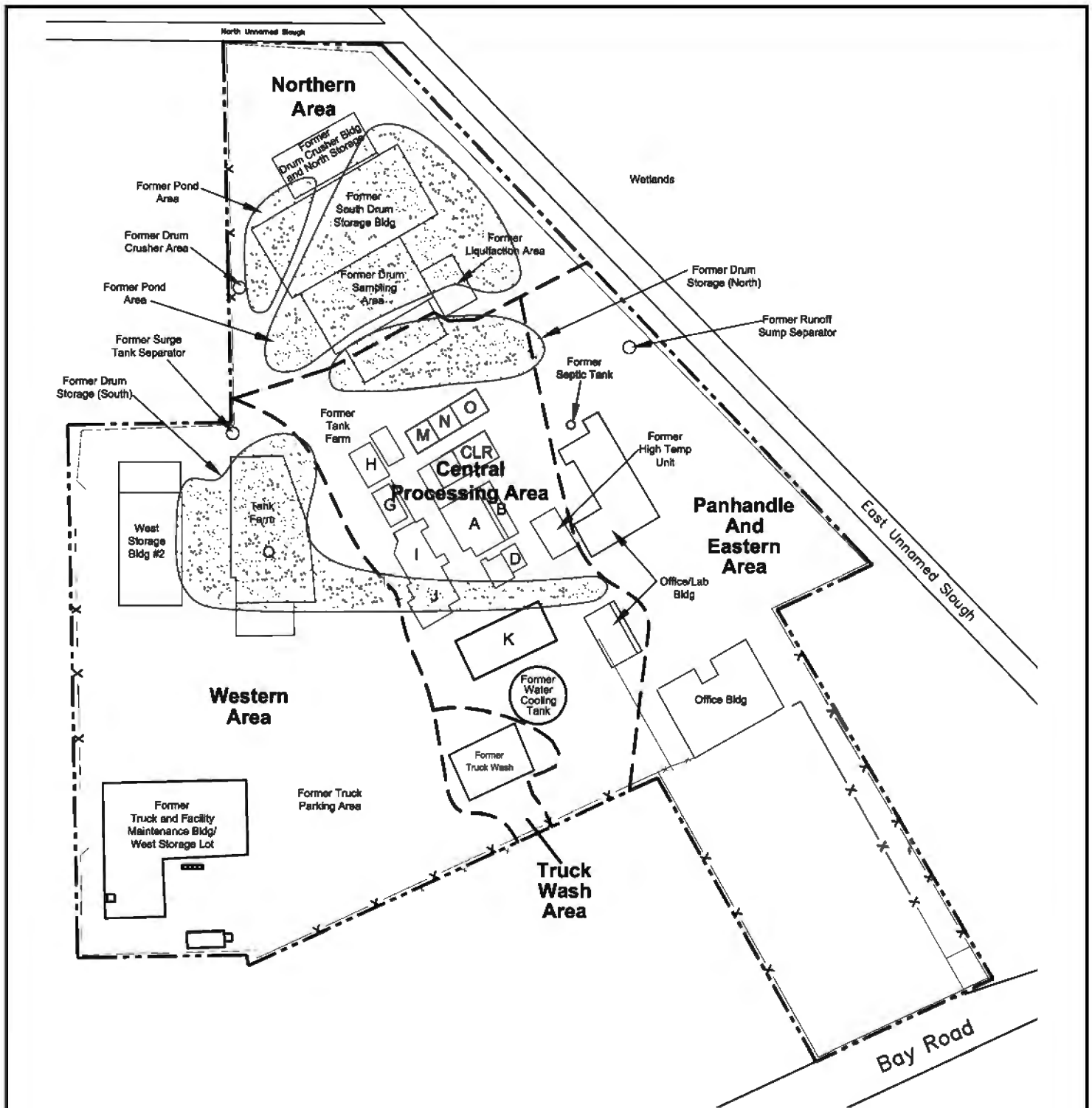

SCALE IN FEET

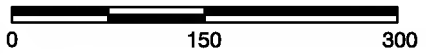

NOTE: DIMENSIONS, DIRECTIONS AND LOCATIONS ARE APPROXIMATE.

Explanation

- Site boundary
- Bldg. Building
- X Fence
- - - Investigation area boundary
- Q Former tank farm designation

REFERENCE: IRIS ENVIRONMENTAL, FIGURE 2, AUGUST 2012.

		SITE PLAN FORMER ROMIC FACILITY CONCEPTUAL REMEDIAL DESIGN PLAN EAST PALO ALTO, CALIFORNIA		FIGURE
				2
PROJECT NO.	DATE			
402212001	2/14			

NINYO & MOORE, INC. 3000 SAN ANTONIO AVENUE, SUITE 100, PALO ALTO, CALIFORNIA 94303



EXPLANATION

--- ROMIC FACILITY BOUNDARY

--- FENCE ENCLOSURE

RW-5A ◉ MONITORING WELL WITH AQUIFER DESIGNATION

RW-17AR ✕ DECOMMISSIONED ABANDONED WELL

VOCs VOLATILE ORGANIC COMPOUNDS

DCA DICHLOROETHANE

DCE DICHLOROETHENE

PCE TETRACHLOROETHENE

TCA TRICHLOROETHANE

TCE TRICHLOROETHENE

ND NOT DETECTED FOR VOC CONSTITUENTS

NS NOT SAMPLED

FP FREE PRODUCT

J ANALYTE VALUE IS ESTIMATED

CONCENTRATIONS IN MICROGRAMS PER LITER (µg/L) OR PARTS PER BILLION.

LEGEND

▲ VERTICAL EXTRACTION WELL*

● VERTICAL INJECTION WELL*

■ APPROXIMATE PIEZOMETER LOCATION*

◉ APPROXIMATE VADOSE ZONE MONITORING WELL LOCATION*

— HORIZONTAL INJECTION WELL*

→ PIPING/CONDUIT RUNS*

— INJECTION WELLS IN TRENCHES*

A-A' CROSS SECTION (SEE FIGURE 4)*

* WELL LOCATIONS ARE CONCEPTUAL AND MAY CHANGE PENDING REVIEW OF SUBSURFACE INVESTIGATION DATA

RW-28A

Date	3/28/2013	6/27/2013
PCE	107 J [108 J]	86.8 J
TCE	1.170 [1.370]	497
Cis-1,2-DCE	6.000 [6.980]	4.030
Trans-1,2-DCE	116 J [136 J]	96.0 J
Vinyl chloride	8.990 [11.200]	3.940
1,1-TCA	84.0 J [97.6 J]	41.4 J
1,1-DCA	318 [363]	225
1,2-DCA	12.200 [14.000]	5.520
1,1-DCE	363 [363]	209
Benzene	284 [292]	214
Toluene	606 [685]	303
Ethylbenzene	158 J [170 J]	82.7 J
Total Xylenes	425 [463]	235

RW-29A

Date	3/25/2013	6/25/2013
Vinyl chloride	1.4	<5.0
1,1-DCA	0.72 J	<5.0
Benzene	2.8	2.9 J
Toluene	2.8	2.5 J
Ethylbenzene	1.3	<5.0
Total Xylenes	2.2	<10

RW-4A

Date	3/26/2013	6/26/2013
Trans-1,2-DCE	4.2 J	2.0 J
Vinyl chloride	4.6 J	4.5 J
1,1-DCA	20.1	16.9
1,2-DCA	<10	3.2 J
Benzene	85.2	81.7
Toluene	89.6	84.0
Ethylbenzene	16.5	13.7
Total Xylenes	71.9	61.2

RW-2A

Date	3/27/2013	6/26/2013
Cis-1,2-DCE	4.0 J	2.6 J
Vinyl chloride	<13	2.2 J
1,1-DCA	<13	2.9 J
Benzene	16.4	25.1
Toluene	356	607
Ethylbenzene	142	211
Total Xylenes	250	360

RW-5A

Date	3/26/2013	6/26/2013
Cis-1,2-DCE	0.86 J	0.82 J
Trans-1,2-DCE	1.6	1.5
Vinyl chloride	1.6	2.6
1,1-DCA	7.5	7.1
1,2-DCA	<1.0	0.24 J
Benzene	0.57 J	<1.0

RW-6A

Date	3/25/2013
1,1-DCA	0.34 J
1,2-DCA	0.27 J

RW-12A

Date	3/25/2013	6/25/2013
Cis-1,2-DCE	0.53 J	0.60 J
Trans-1,2-DCE	0.63 J	0.90 J
Vinyl chloride	0.45 J	1.7
1,1-DCA	0.92 J	1.1
Benzene	<1.0	0.73 J

RW-10A

Date	3/26/2013	6/26/2013
TCE	0.87 J	0.41 J
Cis-1,2-DCE	11.3	2.0
Trans-1,2-DCE	7.7	1.7
Vinyl chloride	64.7	1.7
1,1-DCA	14	3.2
1,2-DCA	0.42 J	<1.0
Benzene	12.8	5.0
Toluene	105	85.9
Ethylbenzene	96.2	55.3
Total Xylenes	215	174

RW-3A

Date	3/28/2013
Cis-1,2-DCE	0.44 J

RW-9A

Date	3/27/2013
TCE	175
Cis-1,2-DCE	260
Trans-1,2-DCE	123
1,1-DCE	3.6 J
Vinyl chloride	77.5
1,1-DCA	21.4
Benzene	1.5 J

RW-13A

Date	3/25/2013
Cis-1,2-DCE	0.28 J
1,1-DCA	0.61 J

RW-16A

Date	3/25/2013
TCE	1.5
Cis-1,2-DCE	14.3
Trans-1,2-DCE	0.51 J
1,1-DCE	0.51 J
Vinyl chloride	15.3
1,1-DCA	3.6
Benzene	0.41 J

RW-26A

Date	3/25/2013	6/25/2013
TCE	<1.0	0.21 J
Cis-1,2-DCE	0.89 J	0.77 J
Vinyl chloride	1.1	2.4
1,1-DCA	1.2	1.4
Benzene	0.53 J	0.55 J

RW-27A

Date	3/27/2013	6/27/2013
TCE	203 [226]	392
Cis-1,2-DCE	776 [896]	1.110
Trans-1,2-DCE	78.7 [89.6]	140
Vinyl chloride	457 [518]	341
1,1-DCA	5.3 J [6.4 J]	6.7 J
1,1-DCE	20.2 [22.3]	30.0
Benzene	<2.0 [2.1 J]	<10

RW-15A

Date	3/25/2013
TCE	0.47 J
Cis-1,2-DCE	0.96 J
Trans-1,2-DCE	0.22 J
Vinyl chloride	0.95 J
1,1-DCA	2.0
Benzene	0.39 J

RW-8A

Date	3/27/2013	6/27/2013
Cis-1,2-DCE	<10	2.5 J
Trans-1,2-DCE	2.7 J	3.7 J
Vinyl chloride	7.9 J	2.9 J
1,1-DCA	19.2	11.8
1,2-DCA	3.6 J	3.3 J
Benzene	52.4	77.0
Toluene	189	610
Ethylbenzene	165	189
Total Xylenes	272	623

RW-1A

Date	3/27/2013
PCE	5.7
TCE	7.8
Cis-1,2-DCE	108
Trans-1,2-DCE	9.8
Vinyl chloride	81.8
1,1-DCA	11.4
1,1-DCE	1.7 J
Benzene	96.2
Toluene	6.1
Ethylbenzene	33.8
Total Xylenes	24.3



NOTE: DIMENSIONS, DIRECTIONS AND LOCATIONS ARE APPROXIMATE.

REFERENCE: ARCADIS, FIGURE 9, AUGUST 2013.

		PROPOSED REMEDIATION INFRASTRUCTURE FOR VADOSE ZONE AND ZONE A AQUIFER FORMER ROMIC FACILITY CONCEPTUAL REMEDIAL DESIGN PLAN EAST PALO ALTO, CALIFORNIA	FIGURE 3
402212001		2/14	

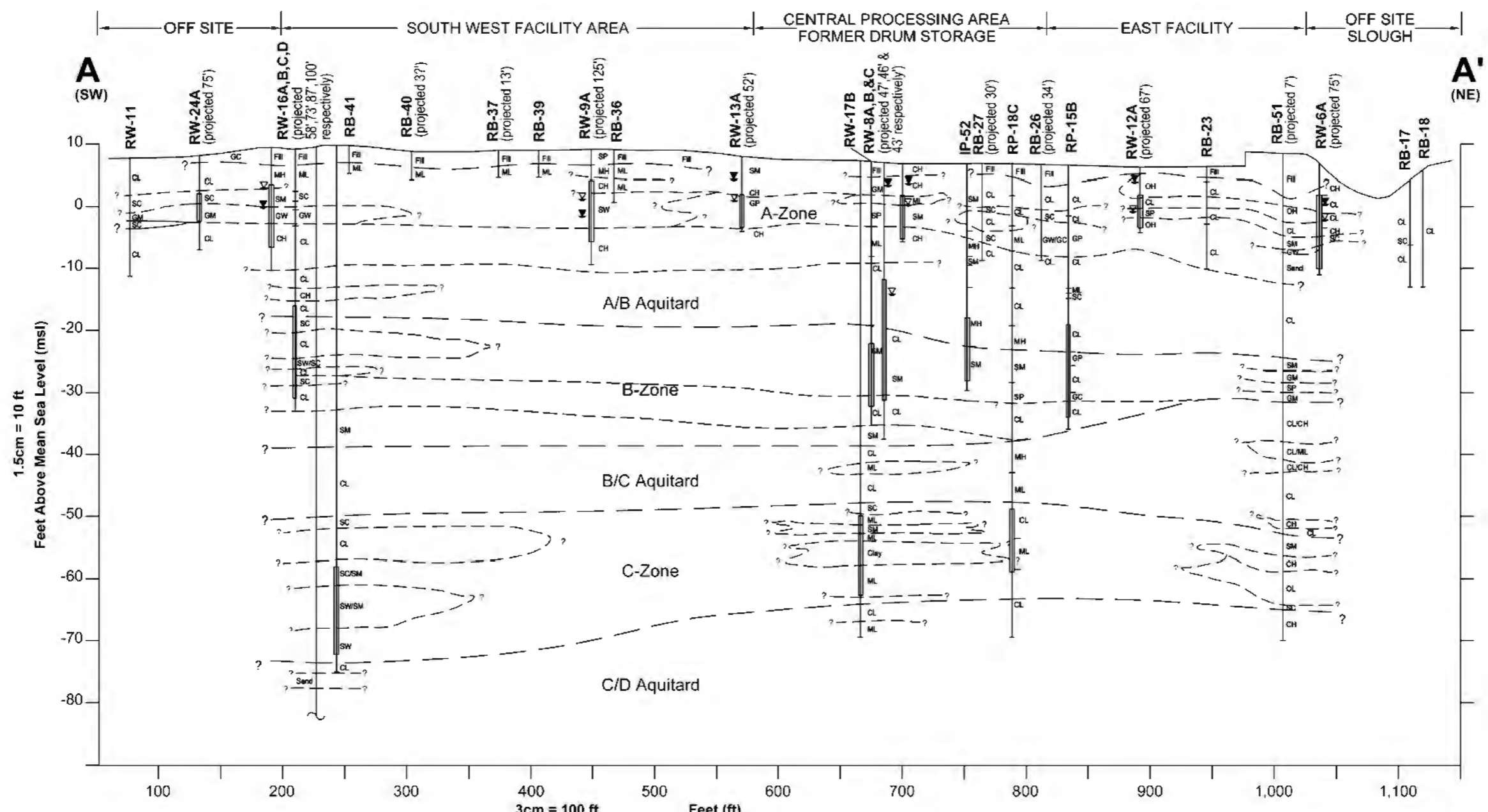

LEGEND

- ? Interpretated major lithologic unit contact
 - ? Interpretated minor lithologic unit contact
 - Static water level (10/03/90)
 - Well screen interval
 - First encountered water
 - Well RW-18D extends to 203 feet below mean sea level
- Cross-section vertical exaggeration is 5:1

- CH Inorganic clays of high plasticity, fat clays
- CL Inorganic clay, sandy or silty clay, low to medium plasticity
- GC Clayey gravels, gravel-sand-clay mixtures, plastic fines
- GM Silty gravels, gravel-sand-silt mixtures, non-plastic fines
- GP Poorly graded gravels or gravel-sand mixtures, little or no fines
- GW Well graded gravels, gravel-sand mixtures, little or no fines
- MH Inorganic silts, diatomaceous or micaceous fine sandy or silty soils
- ML Inorganic silts, sandy or clayey silts, low to no plasticity
- OH Organic clays of medium to high plasticity, organic silts
- OL Organic silt or organic silty clay, low to medium plasticity
- PT Peat and other highly organic soils
- SC Clayey sands, sand-clay mixtures, plastic fines
- SM Silty sands, sand-silt mixtures, non-plastic fines
- SP Poorly graded sands or gravelly sands, little or no fines
- SW Well graded sands, gravelly sands, little or no fines

Adapted from Conor Pacific 1999.

REFERENCE: ARCADIS, FIGURE 3, MAY 2007.

		SITE GEOLOGIC CROSS-SECTION A-A' FORMER ROMIC FACILITY CONCEPTUAL REMEDIAL DESIGN PLAN EAST PALO ALTO, CALIFORNIA	FIGURE
			4
PROJECT NO.	DATE		
402212001	2/14		

RW-11B		
Date	3/28/2013	6/28/2013
PCE	622	
TCE	2,210	
Cis-1,2-DCE	6,950	
Trans-1,2-DCE	22.1 J	
Vinyl chloride	87.5 J	
1,1-DCA	24.0 J	
1,1-DCE	75.5 J	
Benzene	83.9 J	

RW-21B		
Date	3/27/2013	6/27/2013
PCE	5.3 J	<25
TCE	22.8	11.3 J
Cis-1,2-DCE	24.7	27.1
Trans-1,2-DCE	14.1	17.1 J
1,1-DCA	41.5	47.3
1,2-DCA	152	160
1,1-DCE	9.4 J	12.0 J
Vinyl chloride	696	1,410
Benzene	20.5	24.9 J
Toluene	82.3	81.6
Ethylbenzene	20.3	17.5 J
Total Xylenes	44.3	31.5 J

RW-2B		
Date	3/25/2013	6/26/2013
TCE	7.1 J	<10
Trans-1,2-DCE	2.3 J	<10 [<10]
Vinyl chloride	<10	2.1 J
1,1-DCA	10.9	11.2 [10.3]
1,2-DCA	3.1 J	5.8 J [2.4 J]
Benzene	24.7	21.3 [21.4]
Toluene	78.2	20.5 [21.1]
Total Xylenes	27.4	22.8 [23.3]

RW-19B		
Date	3/27/2013	6/26/2013
TCE	13.7 J	29.6 J
Cis-1,2-DCE	58.2	1,600
Trans-1,2-DCE	41.8 J	24.2 J
Vinyl chloride	105	665
1,1-DCA	406	169
1,2-DCA	56.5	2,040
Benzene	12.9 J	<50
Toluene	316	144
Ethylbenzene	200	92.7
Total Xylenes	354	164

RW-5B		
Date	3/28/2013	6/26/2013
TCE	633	1,480
Cis-1,2-DCE	6,230	8,300
Trans-1,2-DCE	103	83.5 J
Vinyl chloride	11,800	6,900
1,1-DCA	283	222
1,2-DCA	3,020	3,730
1,1-DCE	52.3 J	278
Ethylbenzene	61.0 J	53.2 J
Total Xylenes	80.3 J	<400

RW-22B		
Date	3/27/2013	6/26/2013
TCE	3.9 [3.0]	3.6
Cis-1,2-DCE	33.3 [35.5]	9.7
Trans-1,2-DCE	3.9 [3.8]	4.3
1,1-DCA	23 [24.1]	44.1
1,2-DCA	125 [128]	276
1,1,1-TCA	0.43 J [<2.0]	<2.0
1,1,2-TCA	<2.0 [<2.0]	0.72 J
Vinyl chloride	9.5 [12.9]	39.6
Benzene	2.6 [2.3]	4.8
Toluene	0.42 J [<2.0]	<2.0

RW-7B	
Date	3/25/2013
TCE	1.1 J
Cis-1,2-DCE	13.6
Vinyl chloride	1.8 J
1,1,2-TCA	17.2
1,1-DCA	14.7
1,2-DCA	299
1,1-DCE	2.7 J

EW-1B		
Date	3/27/2013	6/26/2013
TCE	1,010	27.9 J
Cis-1,2-DCE	9,650	1,190
Trans-1,2-DCE	108	45.8 J
Vinyl chloride	<100	3,590
1,1-DCA	293	155
1,2-DCA	4,400	325
1,1-DCE	456	64.6 J
1,1,2-TCA	178	<100
Benzene	22.8 J	<100
Toluene	368	181
Ethylbenzene	75.9 J	32.0 J
Total Xylenes	186 J	87.2 J

RW-16B		
Date	3/27/2013	6/26/2013
TCE	44	
Cis-1,2-DCE	79.2	
Trans-1,2-DCE	4.5 J	
Vinyl chloride	154	
1,1-DCE	3.2 J	

RW-17B		
Date	3/28/2013	6/26/2013
TCE	34.0 J	20.2 J [30.3 J]
Cis-1,2-DCE	4,150	5,860 [15,000]
Trans-1,2-DCE	56.5	54.1 [80.1 J]
1,1,2-TCA	<50	43.9 J [89.3 J]
1,1-DCA	276	275 [366]
1,2-DCA	1,900	2,130 [3,500]
1,1-DCE	154	154 [419]
Vinyl chloride	2,360	979 [2,920]
Benzene	116	106 [122]
Toluene	479	466 [600]
Ethylbenzene	103	88.7 [95.0 J]
Total Xylenes	196	175 [237]

RW-14B	
Date	3/25/2013
1,1-DCA	1.1
1,2-DCA	2.6

EW-2B		
Date	3/28/2013	6/26/2013
TCE	<1,000	106 J
Cis-1,2-DCE	18,300	14,200
Trans-1,2-DCE	244 J	198 J
1,1-DCA	1,060	933
1,2-DCA	4,020	1,330
1,1-DCE	864 J	813
Vinyl chloride	38,200	45,000
Benzene	<1,000	151 J
Toluene	1,280	1,090
Ethylbenzene	1,030	933
Total Xylenes	2,280	2,080

- EXPLANATION**
- ROMIC FACILITY BOUNDARY
 - FENCE ENCLOSURE
 - RW-3B MONITORING WELL WITH AQUIFER DESIGNATION
 - EW-1B FORMER EXTRACTION WELL WITH AQUIFER DESIGNATION
 - VOCs VOLATILE ORGANIC COMPOUNDS
 - DCA DICHLOROETHANE
 - DCE DICHLOROETHENE
 - PCE TETRACHLOROETHENE
 - TCA TRICHLOROETHANE
 - TCE TRICHLOROETHENE
 - NS NOT SAMPLED
 - FP FREE PRODUCT
 - J ANALYTE VALUE IS ESTIMATED
- CONCENTRATIONS IN MICROGRAMS PER LITER (µg/L) OR PARTS PER BILLION.



LEGEND

- VERTICAL EXTRACTION WELL*
- VERTICAL INJECTION WELL*
- HORIZONTAL INJECTION WELL - UPPER B ZONE*
- HORIZONTAL INJECTION WELL - LOWER B ZONE*
- PIPING/CONDUIT RUNS

* WELL LOCATIONS ARE CONCEPTUAL AND MAY CHANGE PENDING REVIEW OF SUBSURFACE INVESTIGATION DATA



Ninyo & Moore		PROPOSED REMEDIATION INFRASTRUCTURE FOR ZONE B AQUIFER	FORMER ROMIC FACILITY CONCEPTUAL REMEDIAL DESIGN PLAN EAST PALO ALTO, CALIFORNIA	FIGURE 5
PROJECT NO. 402212001	DATE 2/14			

RW-11C		
Date	3/26/2013	6/26/2013
TCE	0.37 J	
Cis-1,2-DCE	0.43 J	
1,1-DCA	0.89 J	

RW-19C		
Date	3/27/2013	6/27/2013
PCE	11.5 J	7.0 J
TCE	65.9	56.9
Cis-1,2-DCE	77.8	121
Trans-1,2-DCE	11.1 J	6.3 J
1,1-DCA	36.1	13.6
1,2-DCA	126	89
1,1-DCE	10.3 J	15.8
Vinyl chloride	965	658
Toluene	349	187
Ethylbenzene	151	87.2
Total Xylenes	228	129

RW-20C		
Date	3/25/2013	6/26/2013
TCE	1.6 [1.6]	1.2 [1.1]
Cis-1,2-DCE	3.8 [3.8]	3.3 [3.2]
Vinyl chloride	0.84 J [0.90 J]	1.4 [1.2]
1,1-DCE	1.6 [1.6]	0.96 J [0.84 J]
1,2-DCA	6.6 [6.6]	4.6 [4.7]
Benzene	0.26 J [0.26 J]	<1.0 [<1.0]
Toluene	0.21 J [0.22 J]	<1.0 [<1.0]

RW-2C		
Date	3/26/2013	6/26/2013
TCE	19.5	31.4
Cis-1,2-DCE	30	28.2
Trans-1,2-DCE	2.7	2.3
Vinyl chloride	27.7	25.4
1,1-DCA	8.6	7.0
1,2-DCA	131	203
1,1-DCE	34.9	29.7
1,1,2-TCA	5.3	23.4

RW-17C		
Date	3/27/2013	6/27/2013
TCE	5.1 J	<100
Cis-1,2-DCE	<10	35.6 J
1,2-DCA	2.6 J	<100
Ethylbenzene	8.1 J	<100
Total Xylenes	7.4 J	<200

RW-5C		
Date	3/26/2013	6/27/2013
TCE	5.7 J	<100
Cis-1,2-DCE	5.5 J	<100

RW-10C		
Date	3/26/2013	6/26/2013
TCE	0.75 J	1.8
Cis-1,2-DCE	2.2	3.3
Trans-1,2-DCE	1.9	2.1
Vinyl chloride	2.1	4.2
1,1-DCA	0.98 J	0.94 J
1,2-DCA	3.6	2.3
Benzene	1.1	1.4
Toluene	3.4	5.6
Ethylbenzene	0.62 J	0.86 J
Total Xylenes	1.9 J	2.4

RW-8C		
Date	3/25/2013	
Cis-1,2-DCE	1.4	
Trans-1,2-DCE	1.2	
Vinyl chloride	1.3	
Toluene	0.29 J	
Ethylbenzene	0.36 J	

RW-18C		
Date	3/26/2013	6/25/2013
TCE	2.7	4.3
Cis-1,2-DCE	6.6	17.5
Trans-1,2-DCE	0.87 J	2.2
Vinyl chloride	7.2	19.8
1,1-DCA	11	11.4
1,1-DCE	0.22 J	0.35 J
1,2-DCA	9.1	7.5
Benzene	1.1	1.2
Toluene	0.74 J	0.83 J
Ethylbenzene	13.7	19.2
Total Xylenes	1.4 J	1.3 J

- EXPLANATION**
- ROMIC FACILITY BOUNDARY
 - FENCE ENCLOSURE
 - RW-4C Monitoring Well with Aquifer Designation
 - VOCs VOLATILE ORGANIC COMPOUNDS
 - DCA DICHLOROETHANE
 - DCE DICHLOROETHENE
 - PCE TETRACHLOROETHENE
 - TCA TRICHLOROETHANE
 - TCE TRICHLOROETHENE
 - ND NOT DETECTED FOR VOC CONSTITUENTS
 - NS NOT SAMPLED
 - J ANALYTE VALUE IS ESTIMATED
- CONCENTRATIONS IN MICROGRAMS PER LITER (µg/L) OR PARTS PER BILLION.



- LEGEND**
- EXISTING VERTICAL INJECTION WELL
 - ⊕ PROPOSED VERTICAL INJECTION WELL*
 - PIPING/CONDUIT RUNS
 - * WELL LOCATIONS ARE CONCEPTUAL AND MAY CHANGE PENDING REVIEW OF SUBSURFACE INVESTIGATION DATA



NOTE: DIMENSIONS, DIRECTIONS AND LOCATIONS ARE APPROXIMATE.

REFERENCE: ARCADIS, FIGURE 11, AUGUST 2013.

Ninyo & Moore		PROPOSED REMEDIATION INFRASTRUCTURE FOR C-ZONE AQUIFER	FORMER ROMIC FACILITY CONCEPTUAL REMEDIAL DESIGN PLAN EAST PALO ALTO, CALIFORNIA	FIGURE 6
PROJECT NO. 402212001	DATE 2/14			

APPENDIX A

ETEC CASE STUDIES TECHNICAL INFORMATION

Hydraulics of Recirculating Well, Pairs for Ground Water Remediation:

<http://info.ngwa.org/gwol/pdf/042979903.pdf>

Aerobic Degradation at Site 19, Edwards Air Force Base, California:

<http://costperformance.org/profile.cfm?ID=63&CaseID=63>

US EPA Engineered Approaches to *In Situ* Bioremediation of Chlorinated Solvents:

Fundamentals and Field Applications:

<http://www.clu-in.org/download/remed/engappinsitbio.pdf>

Enhanced Biodegradation of TCE by Groundwater Recirculation in a Shallow Aquifer with Dramatic Seasonal Groundwater Elevation Fluctuations

Greg Menna and Jeff Bold, PhD (Brown and Caldwell, Davis, California, USA)
Tim Crummett (USACE, Sacramento, California, USA)
Guy Graening, PE (Brown and Caldwell, Rancho Cordova, California, USA)
Brian Timmins (ETEC, LLC, Portland, Oregon, USA)

ABSTRACT: Brown and Caldwell conducted a pilot test to remediate trichloroethylene (TCE) in groundwater associated with past operation of a Formerly Used Defense Site (FUDS) communication station in Northern California. The TCE in shallow groundwater had not degraded significantly in more than 40 years, likely due to oxidizing conditions. A mobile treatment system was installed that extracted groundwater, treated it with granular activated carbon (GAC), amended it with a carbon substrate plus macronutrients (N and P) and injected the amended water. The treatment system induced recirculation in the shallow aquifer accomplishing two important objectives: 1) extract and treat TCE in the dissolved phase in the source area; and 2) thoroughly distribute the amendment to enhance biodegradation of TCE adsorbed to carbon in the subsurface. A bench scale test was conducted prior to the pilot test to determine dosage of the amendment and effectiveness of enhanced biodegradation. The pilot test established reducing conditions and reduced TCE concentrations by 50% during initial operation in 2009; TCE was reduced from 86 ug/L to 0.51 ug/L. The pilot test continued in 2010/2011 with baseline groundwater sampling. The baseline event indicated that the rise in water table and period of inactivity resulted in a rebound in TCE to 160 ug/L in source area wells and a return to oxidative conditions. Operation of the pilot test in 2010/2011 resulted in TCE decreasing steadily to non-detect (<0.5 µg/L) and 4 µg/L in two performance monitoring wells, based on February 11, 2011 results.

INTRODUCTION

During 1952 to 1969, the U.S. Army constructed and operated a transmitter building, a power generation building, a relay building, barracks, storage buildings, two incinerators, utilities, six Underground Storage Tanks (USTs), four above ground storage tanks (ASTs), twenty-two transformers, two waste oxidation lagoons, two cooling water injection (disposal) wells, and one cooling water supply well (Dynamac, 1992). Department of Defense (DoD) activities resulted in volatile organic compound (VOC), primarily trichloroethylene (TCE), and diesel fuel releases to groundwater beneath the Site. The communication station was shut down and the DoD transferred land ownership to a Native American consortium in 1971 for use as a university for Native American studies. Investigation and cleanup of contaminated groundwater was conducted by the U.S. Corps of Engineers (USACE) under the Formerly Used Defense Site (FUDS) program.

No significant dechlorination has occurred in groundwater at the Site most likely due to oxidizing conditions and the lack of a soluble, biodegradable carbon/energy source existing in the saturated zone. Groundwater sampling and analysis near the TCE source area in early 2009 indicated aerobic conditions with dissolved oxygen (DO) greater than 2 milligrams per liter (mg/L) and oxidation-reduction potential (ORP) values primarily positive (i.e., above zero millivolts [mV]). Total organic carbon (TOC) values are insignificant at less than 5 mg/L and indicated a lack of electron donors. Concentrations of TCE breakdown products (i.e., cis- and trans-1,2-dichloroethylene [cis- and trans-1,2-DCE], vinyl chloride, and ethene) were low or not detected in groundwater. During a meeting on March 17, 2009, the USACE expressed a desire to reduce contaminant mass in the apparent TCE source area of the shallow groundwater plume and several remediation options were discussed. In a subsequent meeting on April 9, 2009 with the California Regional Water Quality Control Board – Central Valley Region (Water Board), the USACE expressed a preference for a remedial technology that amended and recirculated groundwater to enhance the biodegradation of TCE via anaerobic reductive dechlorination. The Central Valley Water Board was amenable to groundwater amendment and recirculation and indicated the pilot test remediation approach would fit under the Site's General Waste Discharge Requirements (WDRs).

Geology and Hydrogeology. The Site is located in California's Central Valley about 9 miles west of the City of Davis and surrounded by agricultural operations. The surrounding area and possibly a portion of the Site are located on the geomorphic unit termed "low alluvial plains and fans" (California Department of Water Resources [DWR], 2003), specifically the Putah Plain. Sediments that form these alluvial fan deposits consist primarily of silts and clays with coarse-grained sediments occurring locally.

Subsurface stratigraphy for the Site was interpreted from cone penetrometer test (CPT) logs and geologic boring and well logs. The maximum depth penetrated was 165 feet below ground surface (bgs). The stratigraphy is comprised of fine-grained units of silt and clay interlayered with coarser-grained sand and gravel units. Small discrete sand lenses were found at depths greater than 40 feet bgs but are discontinuous. There is a relatively continuous sand/gravel layer generally at 25 feet bgs to 40 feet bgs. The thickness of this sand/gravel is approximately 15 feet underlying the Site to approximately 8 feet. Overlying and underlying these permeable sands and gravels are less permeable silts and clays. In the area underlying the historic TCE source area, there is a shallower lens of gravelly sand at 15 feet bgs to 20 feet bgs that does not appear to be connected with the continuous sand/gravel layer discussed above.

Based on the investigation, there appeared to be three hydrostratigraphic zones. They are outlined below in order of appearance from ground surface to the maximum depth logged (165 feet bgs):

- Low permeability silts and clays (0 to 25 feet bgs),
- Permeable continuous sand/gravel unit (generally 25 feet bgs to 40 feet bgs), and

- Low permeability silts and clays and discontinuous sand/gravel units (generally 40 feet bgs to 165 feet bgs).

Groundwater was first encountered at the top elevation of the sand/gravel unit generally at 25 feet bgs beneath the Site. Groundwater elevations presented* are representative of static conditions where depth-to-water levels were measured within existing Site monitoring wells (Figure 1). During all initial investigation phases of Site water level monitoring, static water levels rose to depths above the top of the screened interval for all Site wells. This information suggests confined or semi-confined conditions within the shallow units. Evaluations performed under a 2009 aquifer test showed that wells screened within the 25 to 40 foot sand/gravel unit generally respond consistently with each other indicating that they are hydraulically connected.

Greater than average winter 2010 rainfall resulted in higher groundwater elevations across the Site. On average, elevations measured in all monitoring wells were 10 feet higher than measured in 2009.

Figure 1- Pilot Test Groundwater Elevations

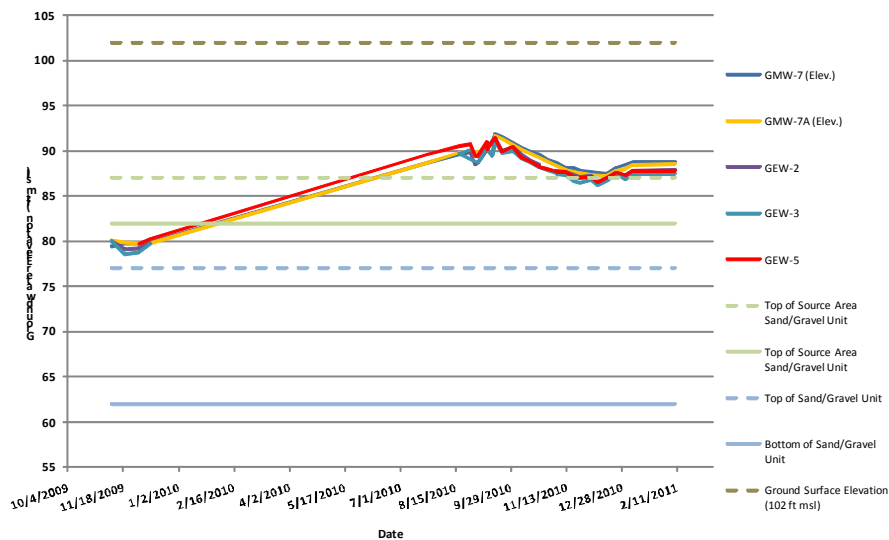

Discontinuous thin lenses of fine sand have been observed during drilling. A connection between the primary shallow water-bearing unit and the deeper sand formation could not be established. Additional groundwater elevation data collected within deeper discontinuous sand lenses supports the same conditions to the maximum depth penetrated where groundwater was encountered (150 feet bgs).

Historically groundwater flow is south-southeast, the same direction as the long axis of the TCE plume, and under a flat gradient of 0.001 to 0.009. February 11, 2011, groundwater elevations reflected extraction and the rebound of water levels while the pilot test system was in operation.

MATERIALS AND METHODS

The primary remediation technology implemented in the pilot test was enhanced bioremediation: amending groundwater with a carbon/energy source to enhance anaerobic biodegradation. Specifically, a nutrient amended carbohydrate was used to overcome terminal electron acceptor (TEA) sinks (i.e., DO, nitrate, and sulfate) and create sulfate-reducing and/or methanogenic conditions throughout the target saturated zone.

*fall down in value or amount of the acceptors

Either of these conditions will promote the transfer of electrons to chlorinated solvents, which will reduce their concentrations and remediate the target area. The intent of the remediation technology is to not only remediate the TCE mass dissolved in groundwater, but also remediate the TCE mass adsorbed onto the organic fraction in the soil matrix as it partitions into the groundwater.

Extraction and injection wells were used to create groundwater recirculation in the target area to promote proper distribution of the amendment. This differs from the goal of a typical “pump and treat” technology demonstration where maximum rates of extraction and injection are desirable to create a capture zone in groundwater. The goal of groundwater recirculation is to use nominal extraction and injection rates to achieve slow groundwater movement through the treatment zone. Too much groundwater movement may be detrimental to anaerobic degradation since it may introduce oxygenated groundwater and promote aerobic conditions. For the groundwater recirculation method, necessary electron donor substrate characteristics include high water solubility and a low retardation factor in order to ensure mobility within the target treatment zone. If the amendment has a low solubility or significant retardation factor, then delivery via induced hydraulic gradients would require multiple pore volumes of recirculation prior to achieving Site-wide delivery.

The 2009-2011 pilot test of enhanced biodegradation and groundwater recirculation consisted of the following activities:

- Extracted groundwater from the apparent TCE source area;
- Conveyed contaminated groundwater from extraction wells to a temporary treatment system;
- Treated TCE in groundwater with granulated activated carbon and adding a substrate and nutrients;
- Conveyed amended groundwater to injection wells;
- Distributed the amendment by recirculating groundwater through the treatment zone; and
- Evaluated the performance of the technology through a monitoring and reporting program.

Treatment System Configuration. A total of 10 groundwater wells were installed during August 2009 to support the pilot test: three extraction wells, five injection wells,

and two performance monitoring wells. The three extraction wells were installed just outside of the treatment zone in a triangular pattern. Four of the five injection wells were installed in the center of the treatment zone while the fifth injection well was installed immediately dowgradient of the treatment zone. During 2009 operations, one injection well was converted to an extraction well. The conversion was made to improve recirculation of impacted groundwater at the downgradient edge of the treatment zone. The two performance monitoring wells were installed in the center of the treatment zone to monitor the potential effects throughout the aquifer zone and at the base of the aquifer zone. The screen interval for the extraction, injection, and one of the monitoring wells was targeted to extend across the thickness of the permeable sand and gravel unit estimated to be between 15 to 40 feet bgs.

In November 2009, a conveyance piping network was constructed aboveground to convey groundwater from extraction wells to the treatment system and to convey amended groundwater to injection wells. The extraction piping connects from the extraction tubes of the submersible pumps to the treatment system influent manifold. The injection conveyance piping connects from the treatment system effluent manifold and leads to the casing and stinger tube of the injection wells. The groundwater extraction and injection flow rate were both targeted at 25 gallons per minute (gpm).

A treatment system was installed to control and monitor the pilot test components, adjust extraction and injection flow rates, remove TCE, and amend the treated water with the substrate and nutrients. The treatment system consisted of the following components:

- Two granular activated carbon (GAC) vessels (liquid phase, 1,000 lbs each);
- Skid-mounted enclosure;
- Programmable control system;
- Amendment delivery system;
- Pumps and holding/mixing tanks;
- Flow meters and pressure gauges; and
- Valves and manifolds.

The contaminated groundwater was treated with two GAC vessels in series. The treated groundwater was amended weekly with the substrate and nutrients (pulse-injected). The amended groundwater was then pumped through the effluent manifold and injection piping to the injection wells for introduction into the aquifer.

A proprietary nutrient-amended carbohydrate substrate (CarBstrate™ by Etec) was used as the amendment in the pilot test to enhance anaerobic degradation of TCE. It is a highly soluble, food-grade product that includes the macro-nutrients that are necessary for effective microbial growth (i.e., ammonia and phosphate) as well as a specific suite of trace metals that have been shown to be critical for active anaerobic microbial activity. The approximate amendment composition is listed below:

- 80 percent dextrose (food-grade corn sugar);
- 17 percent diammonium phosphate; and
- 3 percent yeast extract.

The amendment was a dry powder solid that was prepared at concentrations between 150 and 304 g/L (100 to 200 lbs per 80 gallons) in the mixing tank and injected into treated groundwater to create a target saturated zone concentration approximately 290 mg/L. Since the amendment was approximately 80 percent carbon (from the dextrose), a TOC concentration of approximately 30 mg/L was anticipated in the treatment zone during groundwater monitoring. The desired amendment dose was calculated by using stoichiometric ratios of carbohydrate to TEAs and chlorinated solvents, which was then multiplied by a factor that is based on field experience. Known concentrations of nitrate and sulfate at the Site, and estimated concentrations of iron/manganese, were used to calculate the theoretical mass of amendment required to achieve the desired anaerobic conditions in the treatment zone.

After the treatment system was constructed during November 9-10, 2009, the system underwent shakedown testing on November 10, 2009 and was operational between November 11 and December 10, 2009 and from August 27, 2010 and February 11, 2011. Summaries for operational settings are presented below:

2009 – The system extraction flow rate was approximately 20 gpm; all extraction wells were set between 4 and 8 gpm. Injection of treated and amended water was divided between two galleries: Gallery 1 composed of two wells and Gallery 2 composed of three wells. The system was programmed so that Gallery 1 and Gallery 2 injected sequentially at 25 minutes each with a 10 minute dwell for a 60 min total cycle. The extraction wells operated continuously and any difference in system extraction and injection was equalized in a pre-treatment holding tank. On December 10, 2009 after one month of operation, the treatment system had extracted, treated, and injected a total of 880,451** gallons.

2010/2011 – System component function and layout remained the same. BC reduced the extraction/injection flow rates from approximately 20 gpm to approximately 10 gpm; all extraction wells were set between 3 gpm and 3.5 gpm. The amendment dosage was doubled from 100 pounds to 200 pounds per week. These changes were made to minimize oxidation/aeration of the groundwater and maximize amendment contact in affected area groundwater. On February 11, 2011, after 6 months of operation, the treatment system had extracted, treated and injected a total of 4,034,862 gallons (Table 1).

*** 4 millions thirtyfour thousand Gallons? Yes**

Table 1. Summary of Treatment System Operation		
System Component	Average Flow Rate (gpm)	Total Volume (gal)
<i>Extraction</i>		
DQ-GEW-1*	3.8	82,060
DQ-GEW-5	3.5	919,791
DQ-GEW-3	4.0	1,129,970
DQ-GEW-2	4.0	1,150,640
System Total	11.5	4,034,862
<i>Injection</i>		
DQ-GIW-1	2.4	696,770

Table 1. Summary of Treatment System Operation

System Component	Average Flow Rate (gpm)	Total Volume (gal)
DQ-GIW-2	1.8	505,250
DQ-GIW-3	2.1	597,350
DQ-GIW-4	2.8	790,050
DQ-GIW-5*	3.8	81,718

Reporting period: startup on 11/11/09 through 2/11/11

** On 11/25/09, extraction was discontinued at DQ-GEW-1 and the function of DQ-GIW-5 was converted from injection to extraction*

RESULTS AND DISCUSSION

TCE is the contaminant in the portion of the Site where the pilot test occurred (i.e., the apparent TCE source area and treatment zone). TCE breakdown products consist primarily of cis-1,2-DCE, trans-1,2-DCE, vinyl chloride, and ethene. At the Site, breakdown products are not typically found, with the exception of minor concentrations of cis-1,2-DCE and vinyl chloride. The microorganisms required to reductively dechlorinate cis-1,2-DCE may not be present in sufficient populations to play a significant role. Furthermore, the reduction of TCE requires modestly reduced ORP and DO values. The introduction of the amendment was designed to stimulate the required microorganisms and create reducing conditions.

CONCLUSION

The pilot test established reducing conditions and reduced TCE concentrations by 90% during initial operation in 2009; TCE was reduced from 86 ug/L to 0.51 ug/L in performance monitoring wells. The pilot test continued in 2010/2011 after a hiatus to test for rebound of TCE concentration. The baseline event in 2010 indicated that the rise in water table and period of inactivity resulted in a rebound in TCE to 160 ug/L in source area wells and a return to oxidative conditions (Figure 2).

Figure 2 TCE concentration trends and Site Operations

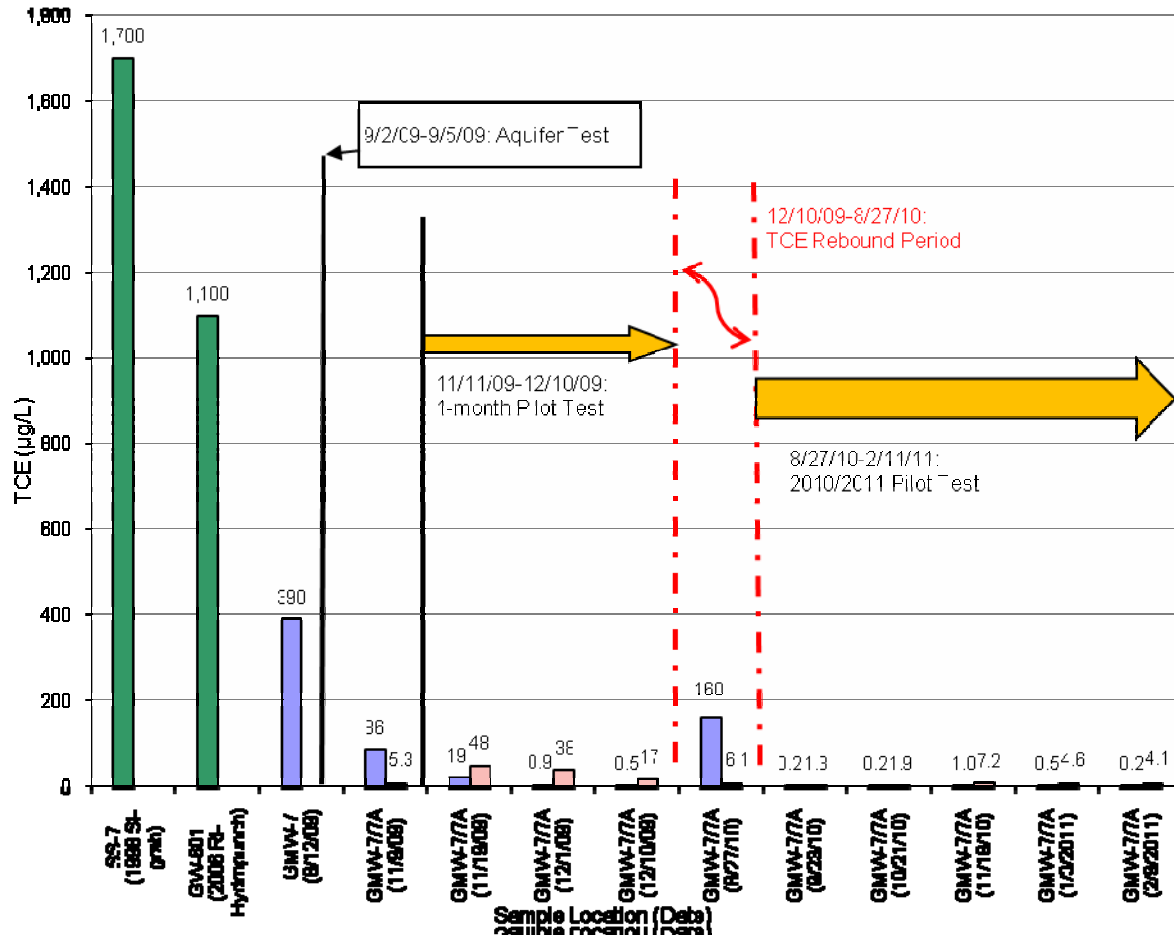

The fact that TCE rebounded indicated that: 1) the amendment dose may need to be increased; and 2) the pilot test may need to be operated for an extended period of time. Continued operation of the pilot test in 2010/2011 resulted in TCE decreasing steadily to non-detect (<0.5 µg/L) and 4 µg/L in two performance monitoring wells based on February 11, 2011 results. The concentration of TCE was reduced by greater than 99% during the 2009 to 2011 pilot test operational period indicating that the enhanced biodegradation and groundwater recirculation was an effective technology to remediate groundwater at the Site.

The following specific conclusions can be drawn from the pilot test:

- The treatment system was maintained with greater than 90% operational uptime;
- TCE has decreased from 86 to 4 µg/L in the treatment zone;
- DO has decreased to below 0.5 mg/L and ORP has decreased to below 50 mV which are conditions typically required for reducing conditions and anaerobic bacteria to function;
- Nitrate and sulfate have decreased to 1.39 mg/L and 53 mg/L, respectively, but may still be at concentrations that compete with reductive dechlorination (i.e., sulfate reducing bacteria may be active);

- A system flow rate of 10 gpm and amendment dose of 200 lbs per week appear to be the optimal treatment settings to achieve the target dose of amendment in the treatment zone;
- TOC increased to near or exceeding the 30 mg/L target for the carbon-based amendment. Operation of the system created a gradient for Site groundwater, in the direction of Site extraction wells. These patterns suggest that the amendment was distributed thoroughly by recirculating groundwater through the treatment zone;
- Concentrations of biodegradation products (ethene, ethane, chloride) have remained constant while methane concentrations have increased significantly indicating that methanogenic microorganism activity has likely increased;
- Changes to secondary water quality parameters included a temporary increase of arsenic, manganese and iron. Other secondary water quality parameters (i.e., pH and TDS remain unchanged; and
- The lack of TCE daughter products prevents a definitive conclusion that biodegradation rates have increased and an assessment of whether bioaugmentation is needed. However, it appears that the combined technologies of groundwater recirculation and enhanced biodegradation have been effective at reducing TCE concentrations.

PERFORMANCE OF ENHANCED ANAEROBIC DECHLORINATION (EAD) VIA GROUNDWATER RECIRCULATION AT A SOUTH FLORIDA STRIP MALL

BRIAN TIMMINS, Director
ETEC, LLC

FRED KAUB, President
STAN RUTKA, PM
GFA



MAY, 2012



Roadmap

1) **It's All About Delivery!!!** Why automated equipment systems provide powerful delivery platforms to support site-wide biological degradation of target contaminants.

APPROACH/ENGINEERING

2) **Fundamentals of EAB:** An overview of the laws that govern biological degradation of organic compounds.

SCIENCE/CHEMISTRY

3) **South FL Case Study:** Field application of the technology/approach, and associated costs.

RESULTS/COSTS

IT'S ALL ABOUT DELIVERY!!!

ISD Recirculation Concept

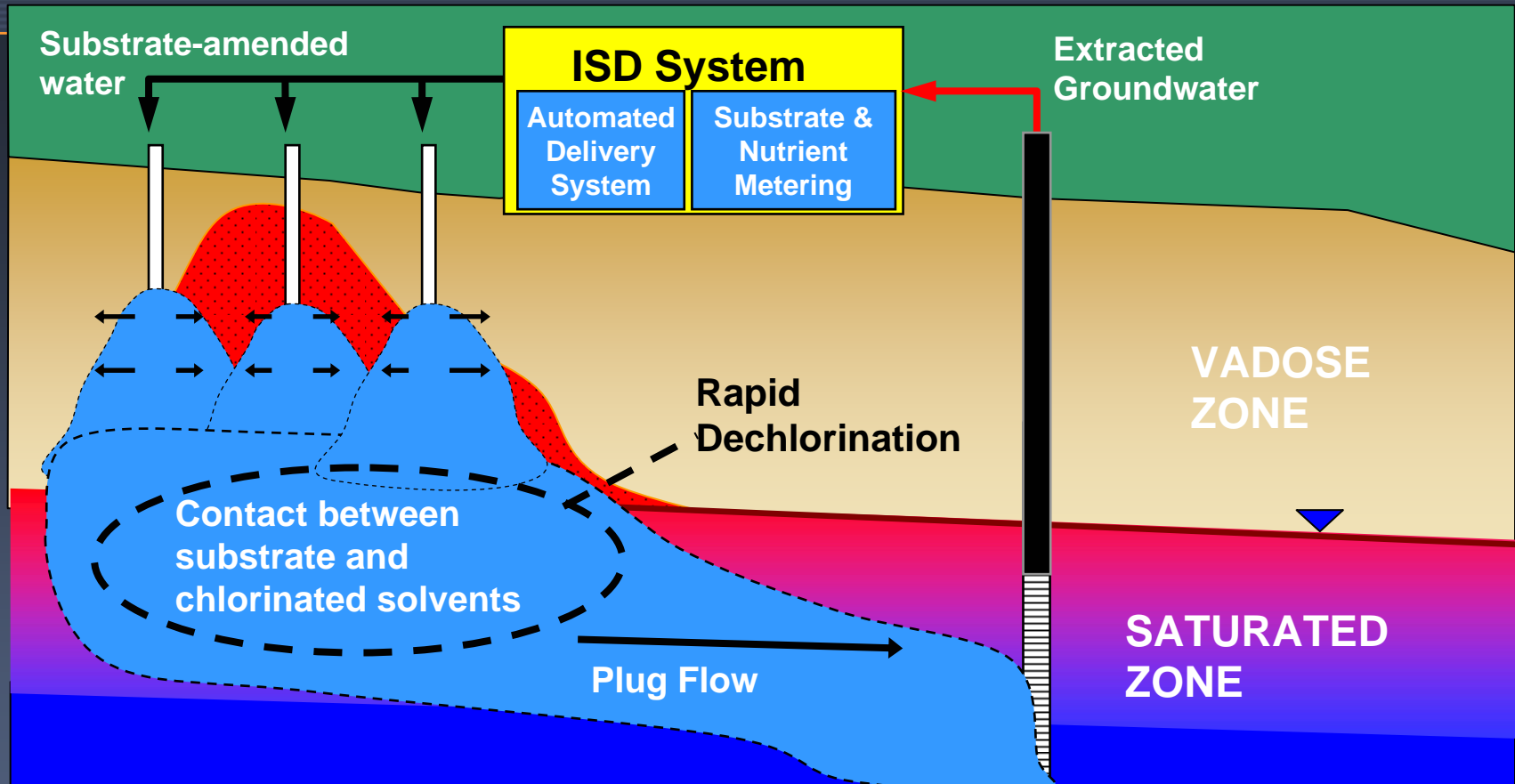

- ❑ Effective substrate delivery via 24/7 GW recirculation - NO SLUG INJECTIONS
- ❑ Highly soluble substrate, plus nutrients, to grow active biomass in pore space
- ❑ Max. microbial activity, ↓ ORP, methanogenic cond., no significant rebound

Why Recirculation?

- **Rapid Contact is Achieved** – Dissolved & Adsorbed
Shorter Remedial Timeframe
Dealing with Plug Flow Situation
- **Direct Hydraulic Influence and Capture**
Don't spread contamination
Protective of Downgradient Receptors
- **Maximizes Concentration Gradient Between Soil/GW**
Increases Dissolution
- **Achieves Mass Balance**
- **Depth Below Surface is Not a Limitation**
- **Biomass Generation, Site-wide Activity**
- **Mitigates pH Shifts**
- **Cost-effective**

Fundamentals of Enhanced In Situ Bioremediation (EISB)

Just like humans/plants, microbes need very specific items to survive and thrive, including:

- Something to eat (petroleum hydrocarbons, organics, etc.)
- Something to respire with (oxygen, nitrate, sulfate, etc.)
- Vitamins/nutrients (nitrogen, phosphorous, etc.)

➤ ***It's All About Delivery/Contact!***

➤ ***Achieving right microbial conditions (pH, temp., salinity, etc.)***

➤ ***Maximizing biodegradation via adding all necessary amendments at the appropriate masses/volumes (i.e. mass balance approach)!!!***

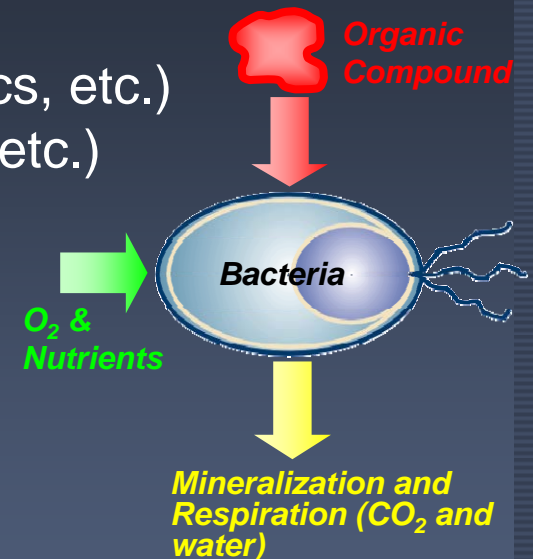

SCIENCE: Terminal Electron Acceptor Process

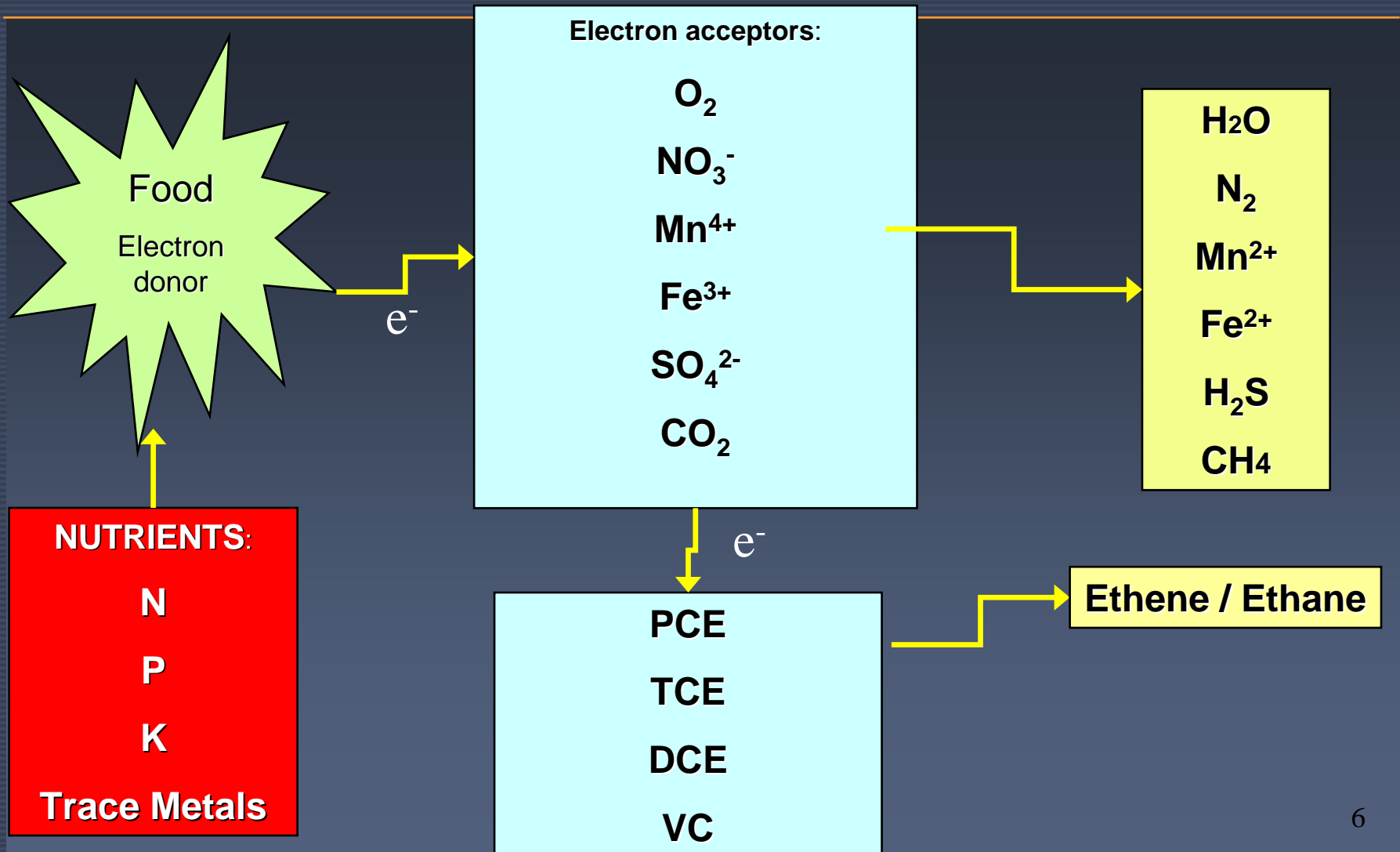

Reductive Dechlorination Pathway

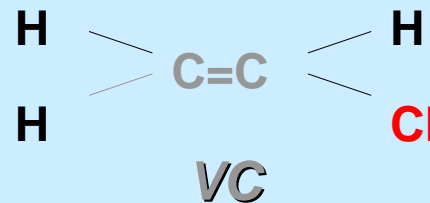
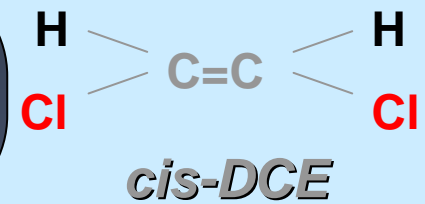
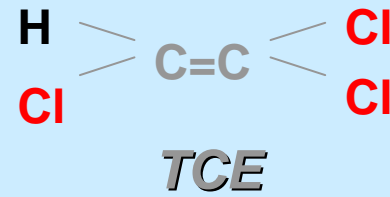
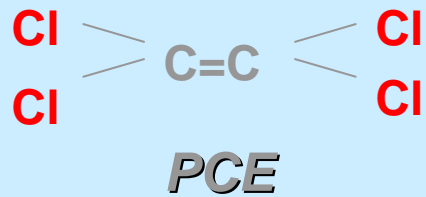

Ethene is end-product
of complete
dechlorination.

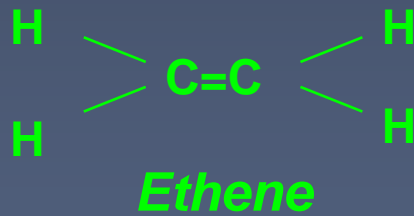

What Type of Substrates?

KEY PHYSICAL/CHEMICAL PROPERTIES:

- High Solubility Limit (>100 mg/L)
- No particle size, fully dissolved
- Low Retardation Factor
- Viscosity like water
- Low cost
- Food grade or benign to potential receptors
- Nutrient-amended (**N**, **P**, and micronutrients)

Case Study:

Active Dry Cleaning Facility Southwest Florida Strip Mall

Site Description

- Large Strip mall in SW FL
 - Exact origin of solvent release was known and well characterized in 2007
 - Extensive network of MWs in shallow, intermediate, and deep zones
 - Highly Active Site, Used Directional Drilling to Minimize Disturbance
- Solvent Concentrations in GW
 - Baseline PCE was less than 100 ppb, TCE concentrations ranging from 10-3,500 ppb showing significant natural degradation
 - Baseline cis-DCE ranging from 500 ppb to 1,000 ppb, and VC at ND, showing natural attenuation capacity to degrade to VC was inadequate
 - Observed total cVOC concentrations as high as 16,500 ppb
- Hydrogeology
 - Fine to medium sand with some organic layers and shell material. Groundwater was high in humic/fulvic acids, “tea colored”.
 - Continuous lower clay confining unit at 20-23 ft bgs
 - DTW ranging from 4 feet to 8 feet bgs
- Target Plume Zone
 - 300 feet x 125 feet x 15 ft thick (entire plume), **pore volume 850,000 gal**
- Remediation Goals
 - GCTL criteria for GW: PCE (3 ppb), TCE (3 ppb), cis-DCE (70 ppb), VC (1 ppb)

Remedial Process

- ISD Recirculation System installed at the site in January 2010, consisting of:
 - 10-gpm system with PLC automation
 - No Pre-treatment
 - 5 extraction wells (squares)
 - 9 injection wells (circles)
 - 3 horizontal injection wells under bldg (J, K, and L).
 - 7,500 lbs. of substrate injected over a 24-months
 - **6.0 Million Gallons** of GW recirculated within 24-month operating period, **seven pore volumes**
 - Directional drilling. No trenching required.

Site Layout

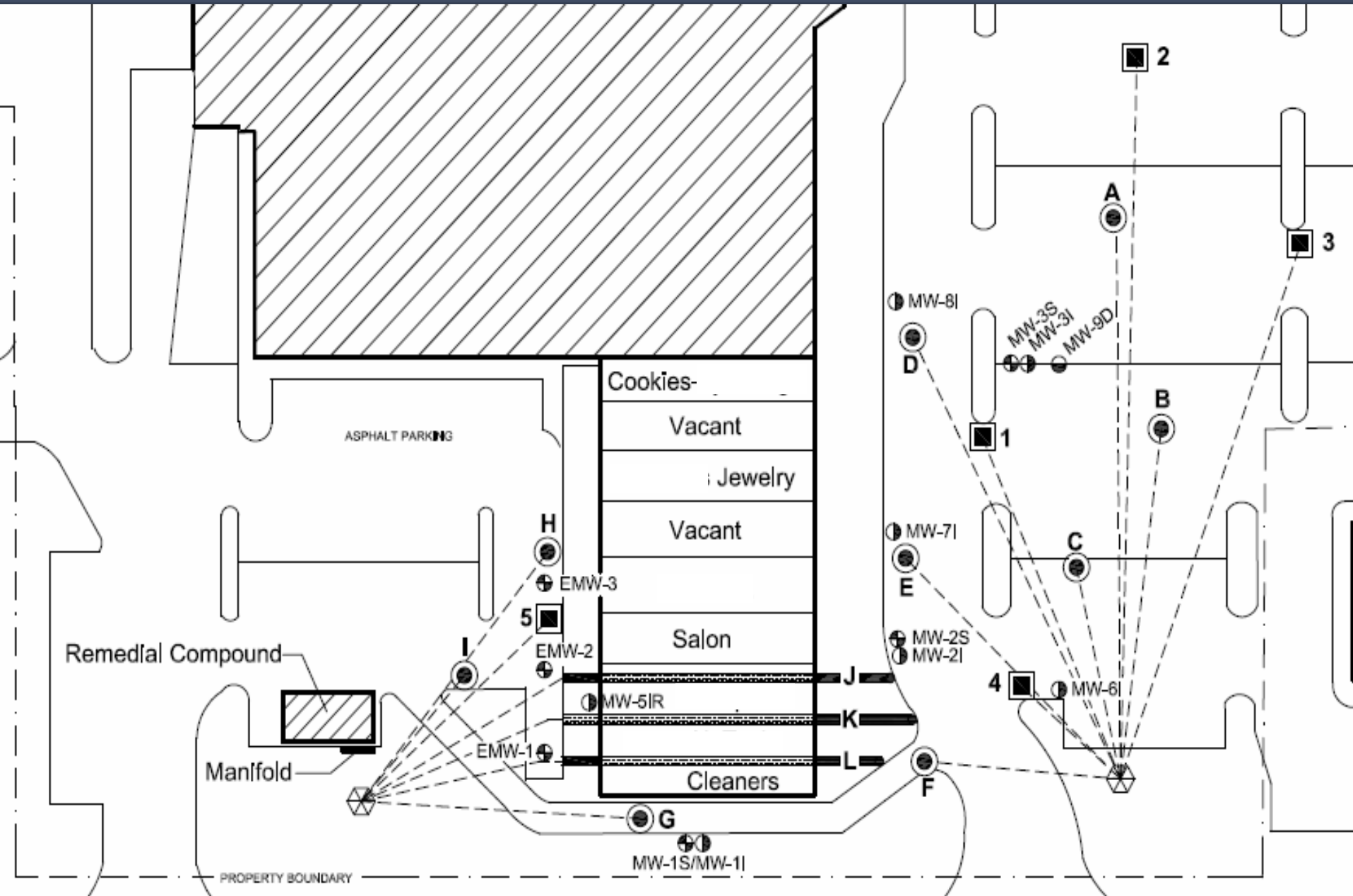

System Installation - Trenchless



System Installation – Horizontal Injection Wells Under Building



System Installation



ISDTM In Situ Delivery Systems

ISD – 10, 20, and 40 GPM Systems – Large Scale Recirculation Platforms with Walk-in Enclosures

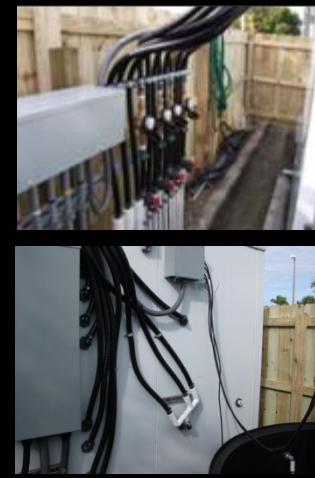

ISD- 10 GPM Pilot-Scale Systems – Small-Scale/Short –Term Recirculation Systems



RUNNING

RUNNING

RUNNING

RUNNING

INJECTION PUMP

BOOSTER PUMP

METERING PUMP

BULK FEEDER

OFF

AUTO

MAN

OFF

AUTO

MAN

OFF

AUTO

MAN

OFF

AUTO

MAN

RUNNING

HOLDING TANK MODE

PROGRAM STATUS

RUNNING

MIXER

FILL MODE

INACTIVE

COMPRESSOR

OFF

AUTO

MAN

CYCLE START/STOP

AREA VALVE STATUS

AUTO

**RUNNING
PRESS TO STOP**

INACTIVE

MIX TIME ENTRY

DWELL COUNT DN

DWELL SP

HI PSI SP

ALARM RESET

ALARM

1

0

0

0

RESET

ACKNOWLEDGED

TIME/DATE

LOW DWELL SP

PSI

LO PSI SP

ALARM HISTORY

GO TO

**11:58:05
06-SEP-07**

1

0

0

**Alarm
History**

**SCREEN
NAVIGATOR**

System Operation - Startup

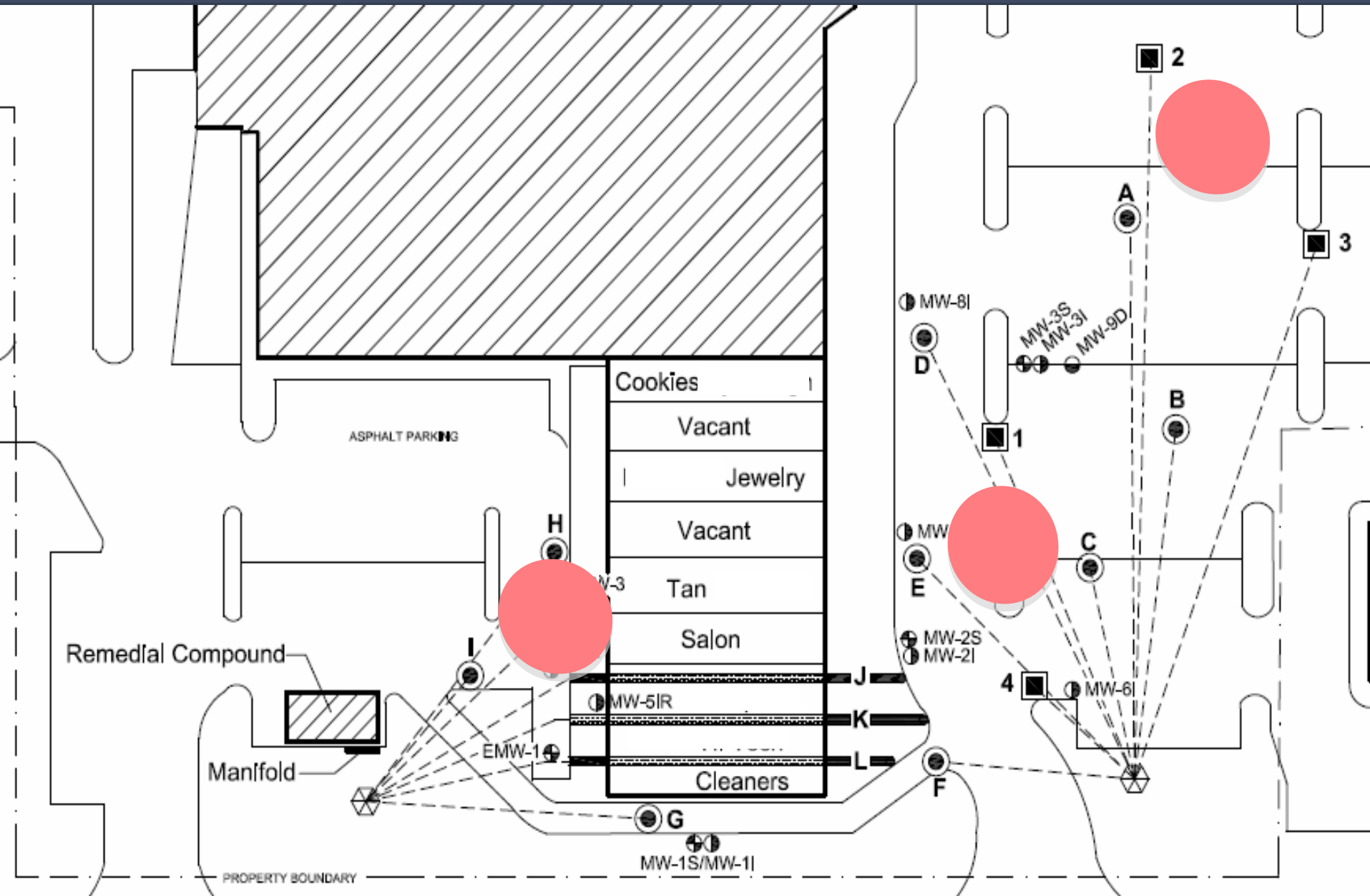

System Operation– At 12 months

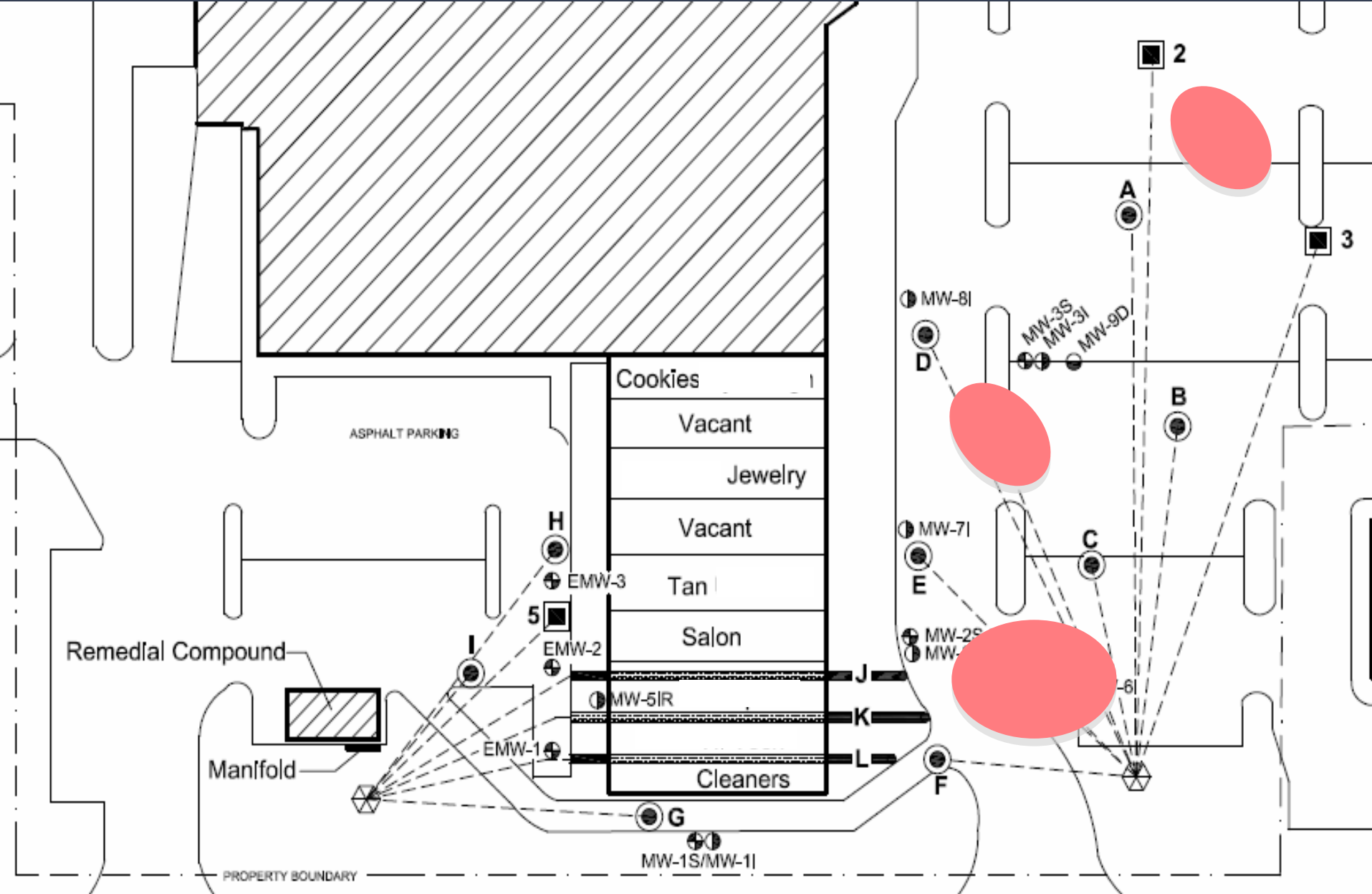

System Operation– At 21 months

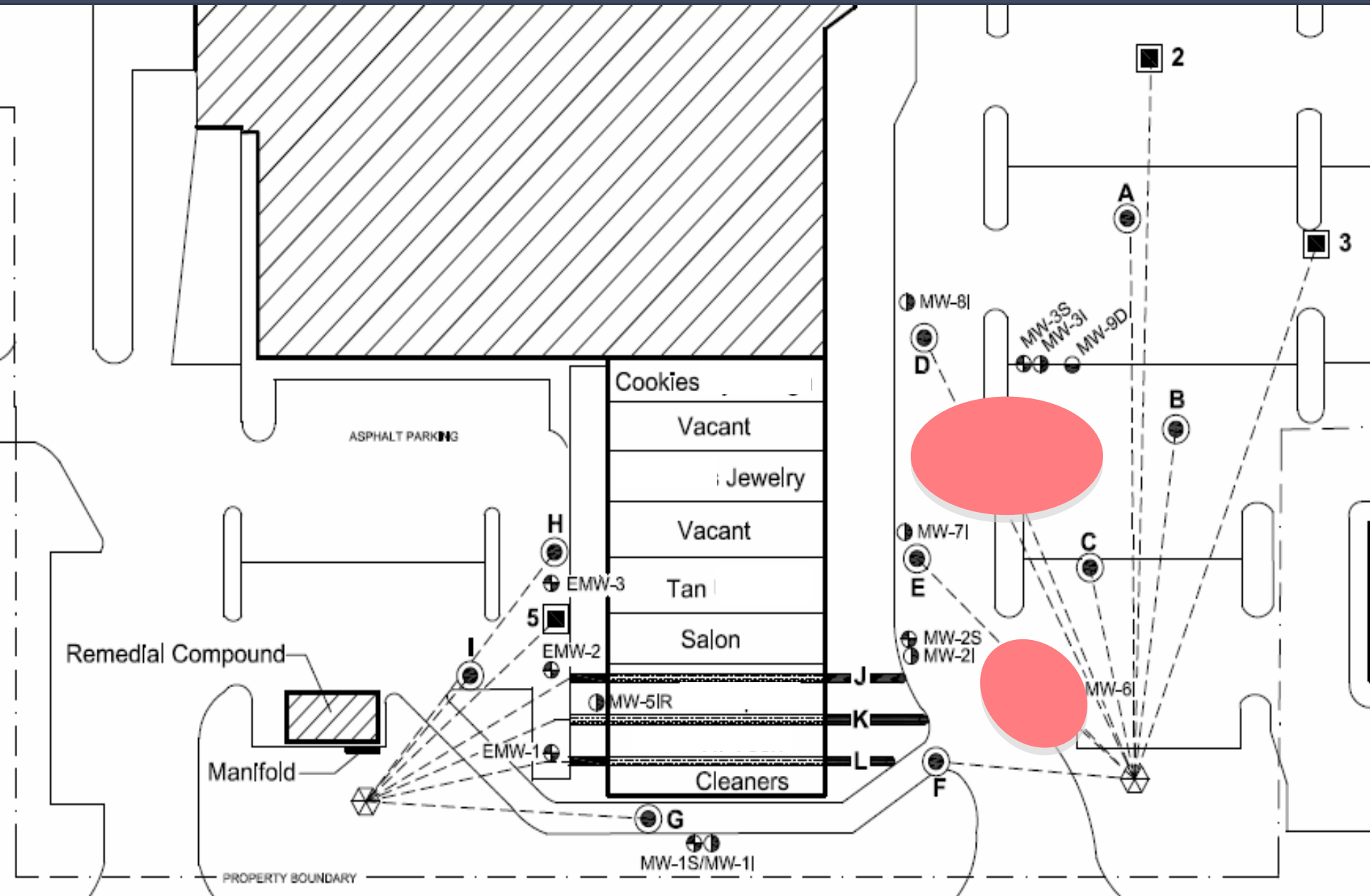

Humic/Fulvic Acids GW



Release Area Data

MW-5I Solvent Concentrations in GW (ppb)

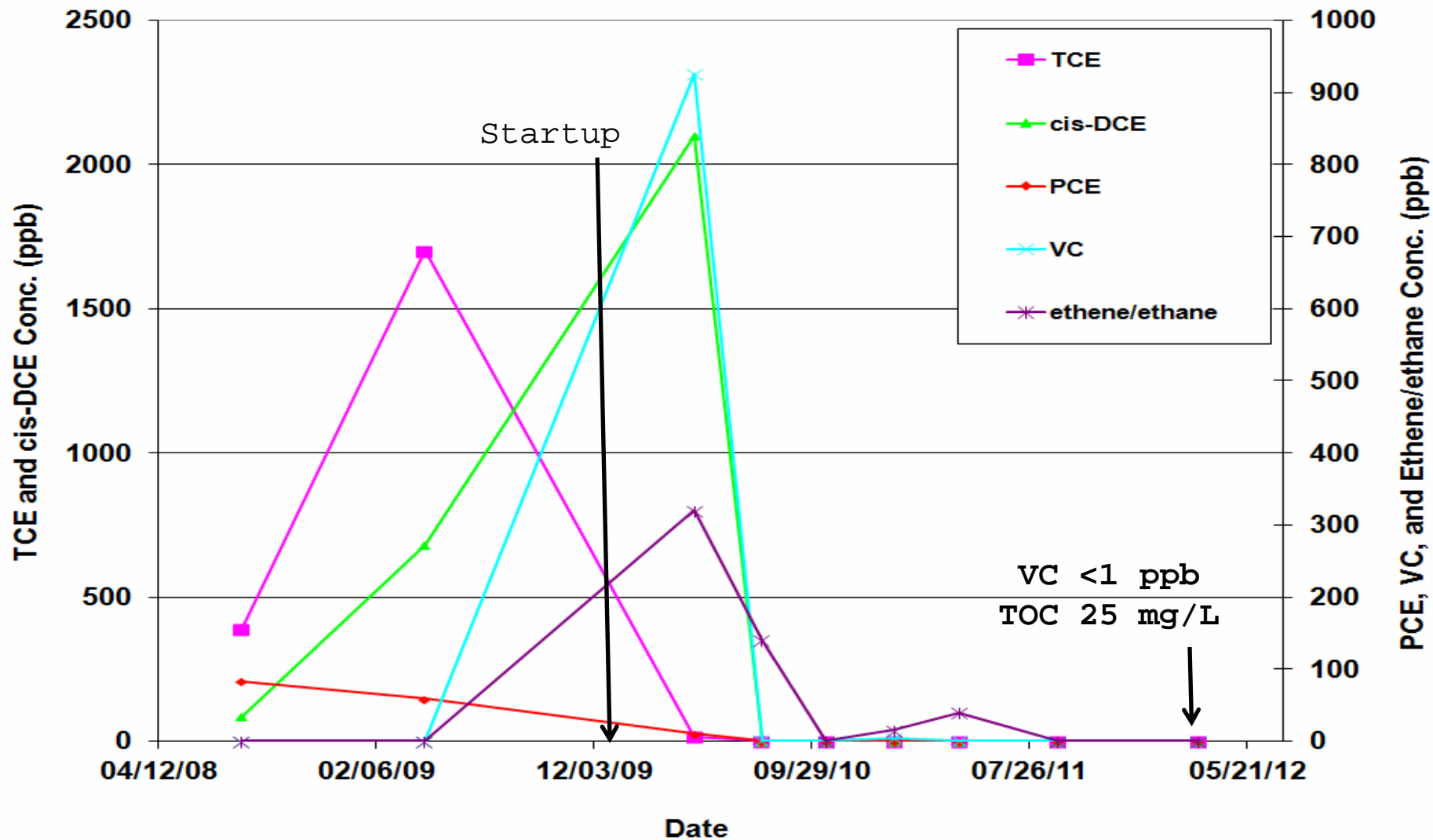

Other Side of Building from Release Area

MW-2I Solvent Concentrations in GW (ppb)

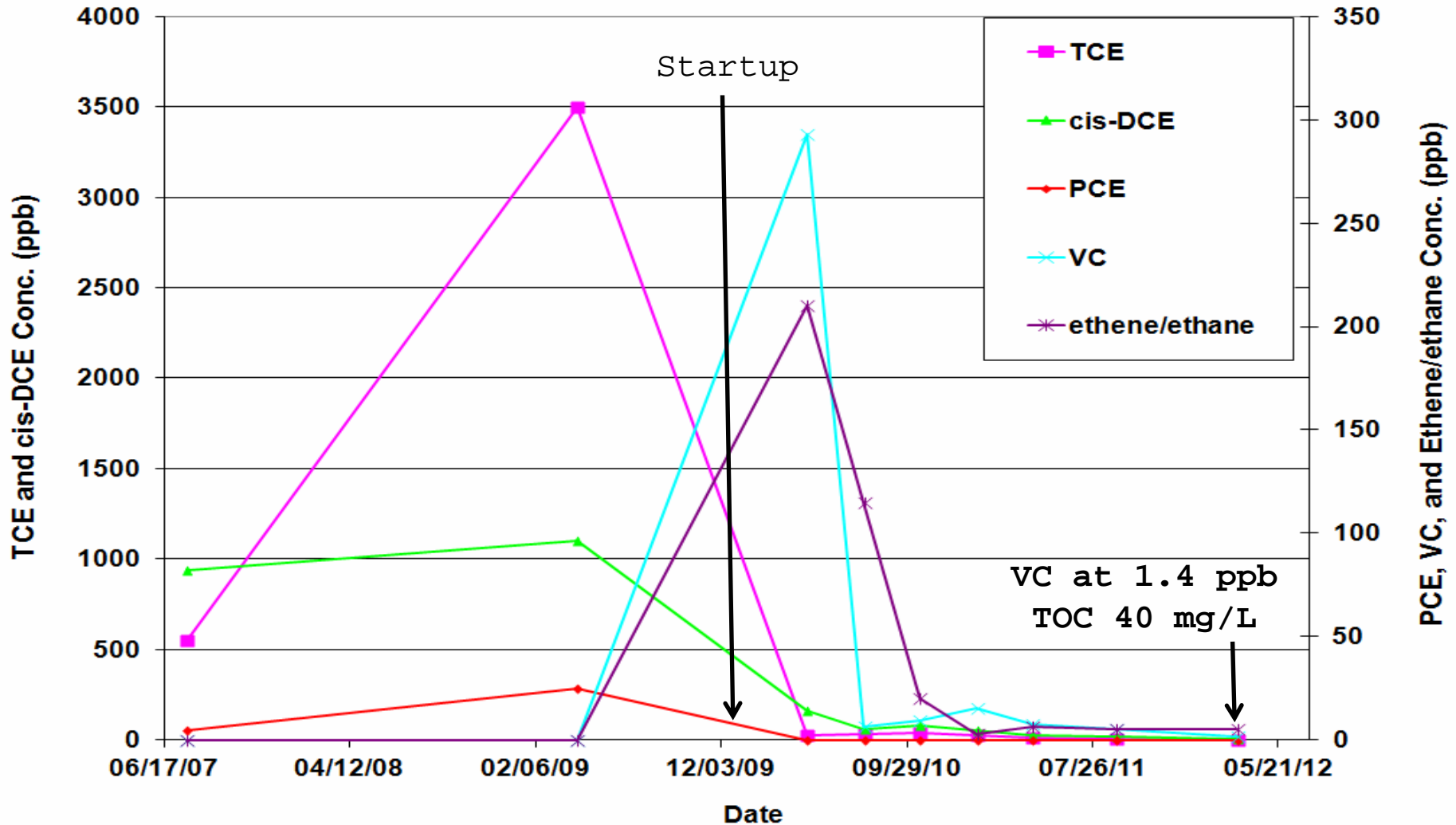

Other Side of Building from Release Area

MW-7I Solvent Concentrations in GW (ppb)

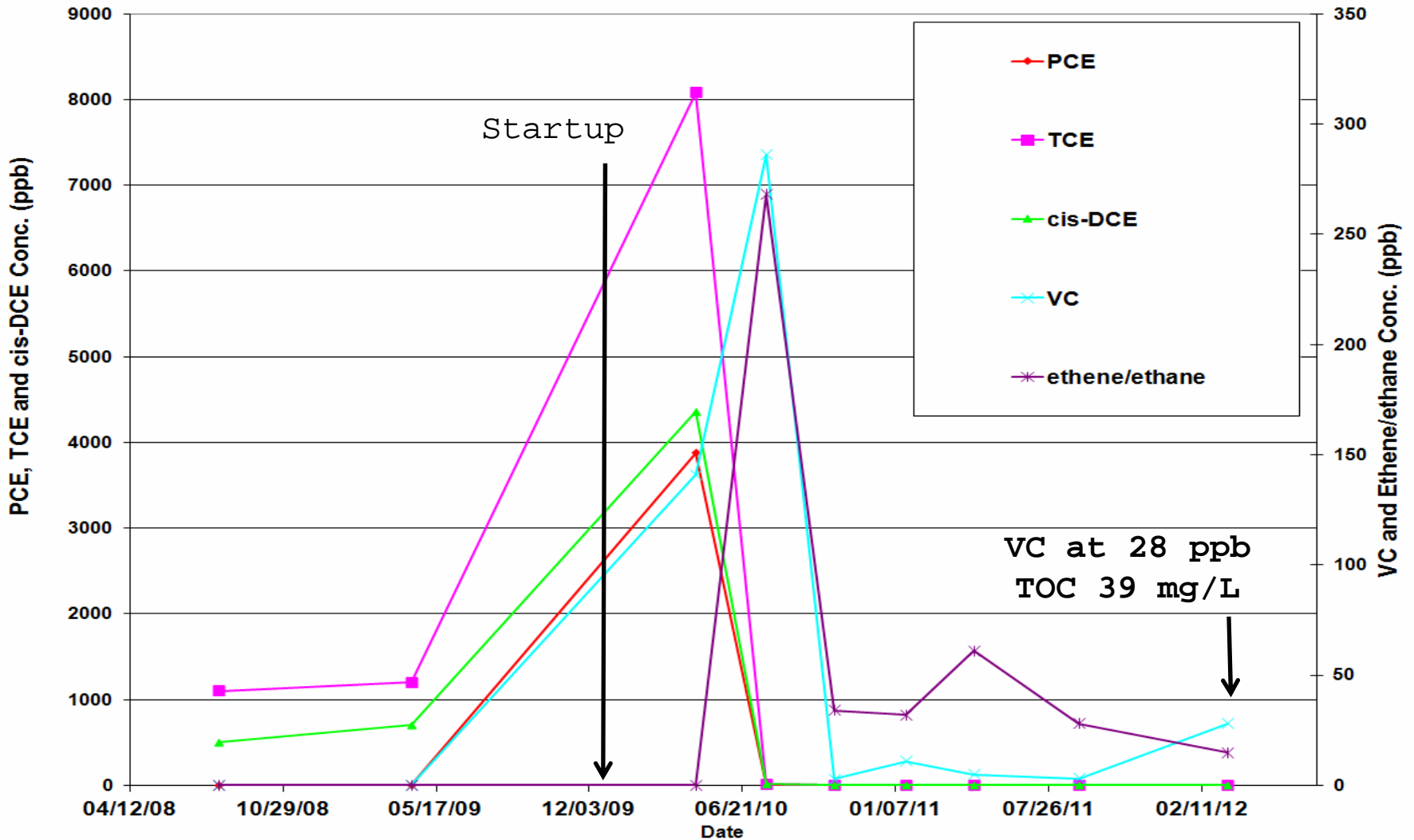

Other Observations in GW

- pH is 6.5-7.2 site-wide
- DO is below 1 mg/L site-wide
- ORP was negative except at one shallow MW, already shifting back positive upgradient upon shutdown.
- Increase in ferrous iron (< 9 mg/L), and a decrease in sulfate (baseline as high as 37 mg/L) site-wide
- No significant buildup of ammonia (ND to 3 mg/L) or phosphate (ND to 4 mg/L). Added 1,500 lbs of ammonia/phosphate (equates to 170 mg/L and 42 mg/L in 1 pore space, respectively.)
- Methane concentrations are low (1-2 mg/L)
- Ethene/Ethane detections site-wide
- TOC concentrations ranged from 30-60 mg/L

CONCLUSIONS

- Soluble Substrate + Nutrients + Recirculation + Infrastructure = Rapid, Site-wide Anaerobic Dechlorination
- Works w/ varying conditions (low/high flow, ppm/ppb, co-mingled)
- Control subsurface conditions/microbial needs
- Nutrient Demand
- Limited Biofouling (pressure inj., pulsed delivery)
- UIC permitting: Pre-treatment may be required.
- Site Characterization is CRITICAL!
- Cost Range is cheaper than excavation/disposal (\$4-45/CY).
- No significant VC generation
- Time comparison is like no other biological approach, kinetics much faster, and rebound is minimized due to the contaminant mass desorption from the soil matrix.
- Cost to achieve NADCs significantly lower than GCTLs.
- Site is has no detectable PCE/TCE, cis-DCE under 5 ppb site-wide, VC detections in 4 MWs ranging from 1-3 ppb, 2 wells have 11 and 28 ppb VC remaining. Nothing left to create VC, MNA will mitigate.