

Full-Scale Permanganate Remediation of a Solvent DNAPL Source Zone in a Sand Aquifer

Beth L. Parker, Ph.D.
University of Waterloo



Presented at the EPA Seminar:
In Situ Treatment of Groundwater Contaminated
With Non-Aqueous Phase Liquids
Chicago
December 11, 2002

1

Collaborators

- Tom Al, University of New Brunswick
– Inorganic Geochemistry
- Ramon Aravena, University of Waterloo
– Isotope Geochemistry
- John Cherry, University of Waterloo

2

This Case Study Will Show:

- Density driven distribution of KMnO_4 in sand
- Performance assessment with minimal uncertainty
- Nearly complete destruction of TCE and 1,1,1-TCA

3



Two General Approaches for In Situ Oxidation

- Inject-and-withdraw (**active**)
Flushing
- Inject-and-leave (**passive**)
Episodic Injection

The Active Approach

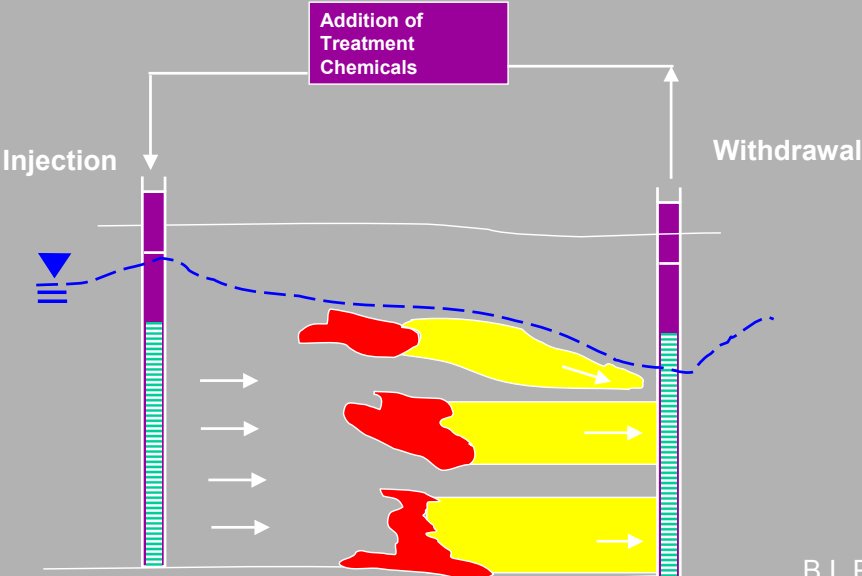

The Waterloo Passive Approach

- ➔ • Use density and dispersion effects to distribute permanganate solution
- Inject in a manner that minimizes groundwater displacement

6

The Waterloo Passive Approach

Relies on density and dispersion effects

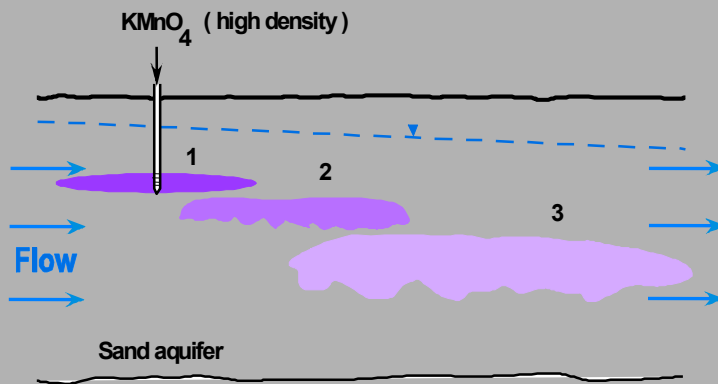

7

B.L.Parker, 1997

Evolution of a Single Disc in a Sand Aquifer

no lateral groundwater flow

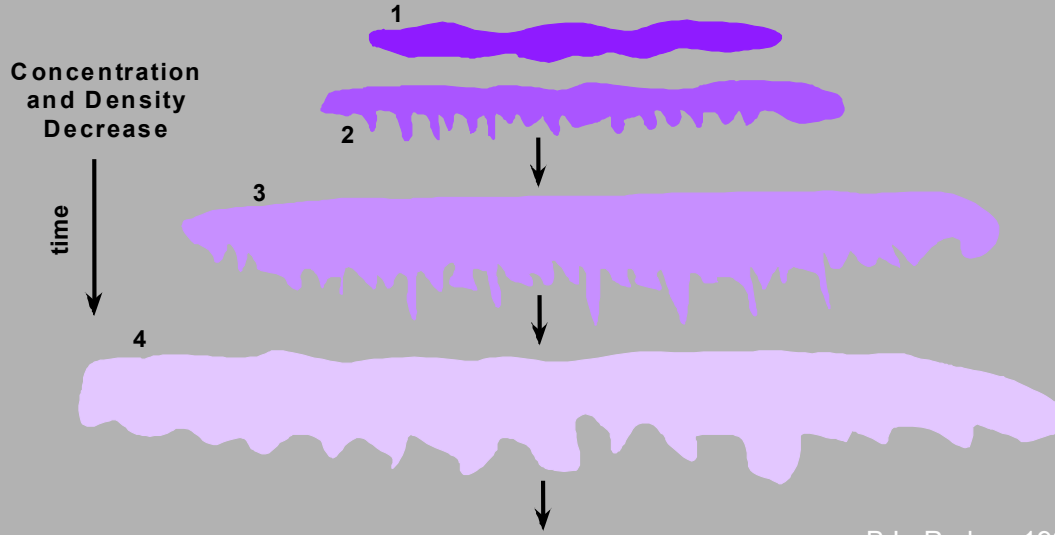

8

B.L. Parker, 1997



Initial Proof - of - Concept

Inject-and-Leave Field Trial in Borden Aquifer

Matthew Nelson M.Sc. Thesis (1999)
Supervisors: Drs. Beth Parker and John Cherry
University of Waterloo

Borden 9x9 m Sheet Pile Enclosure



10



**System Set-up
at 9m Cell
Borden Site**



11

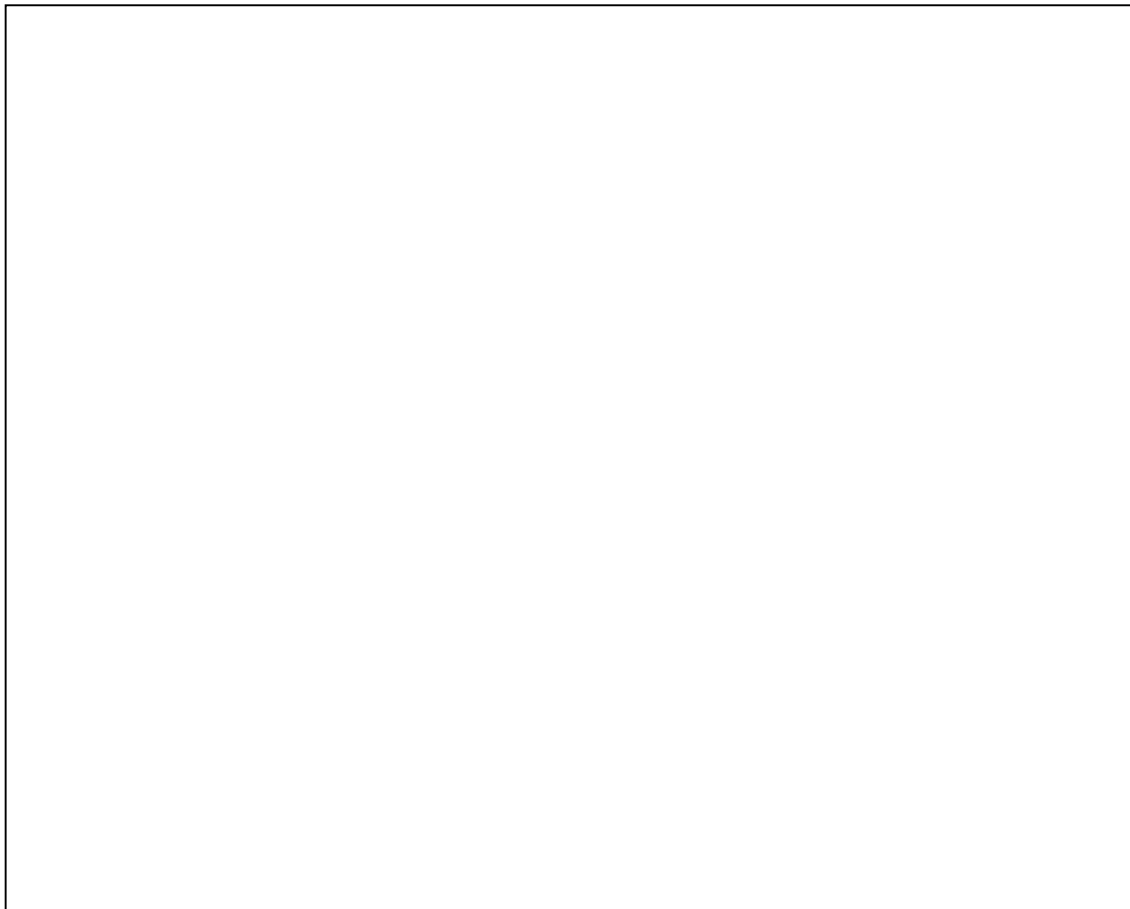

Density of Dissolved KMnO_4 in Water

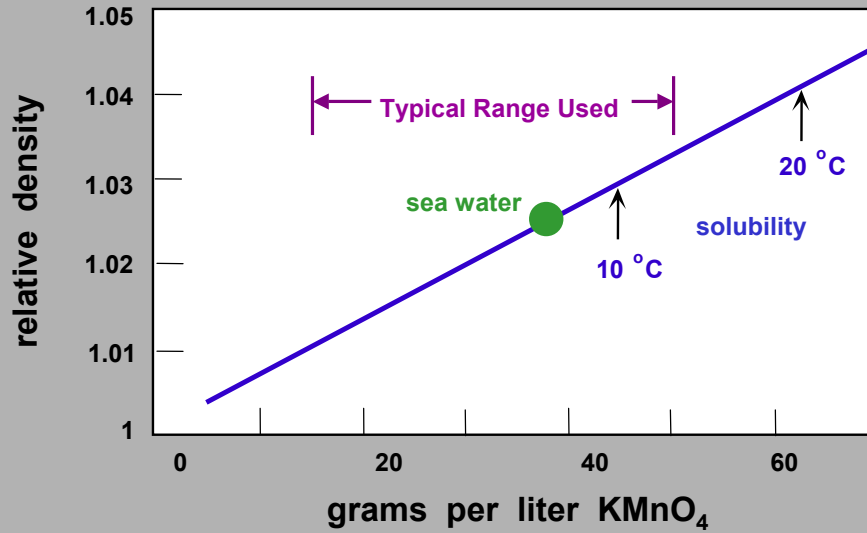

12

SETTING

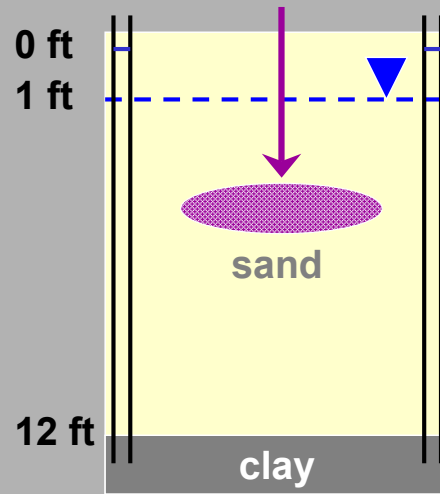

13



Evidence for Density Induced Flow

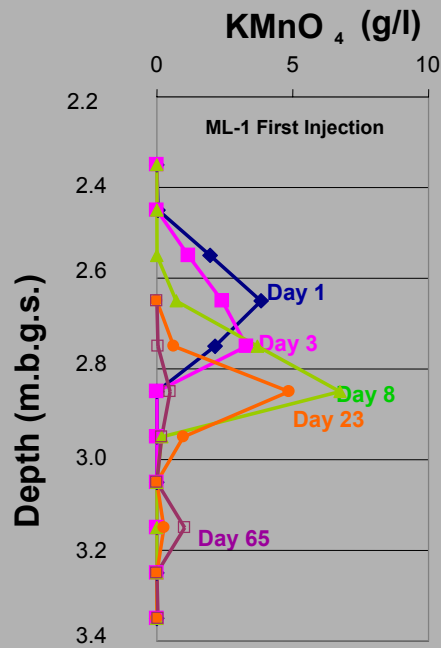

14

(Nelson, 1999)

The Waterloo Passive Approach

- Use density and dispersion effects to distribute permanganate solution
- ➔ • Inject in a manner that minimizes groundwater displacement

15



Long-Screen Injection Causes Large Displacement of Contaminated Water

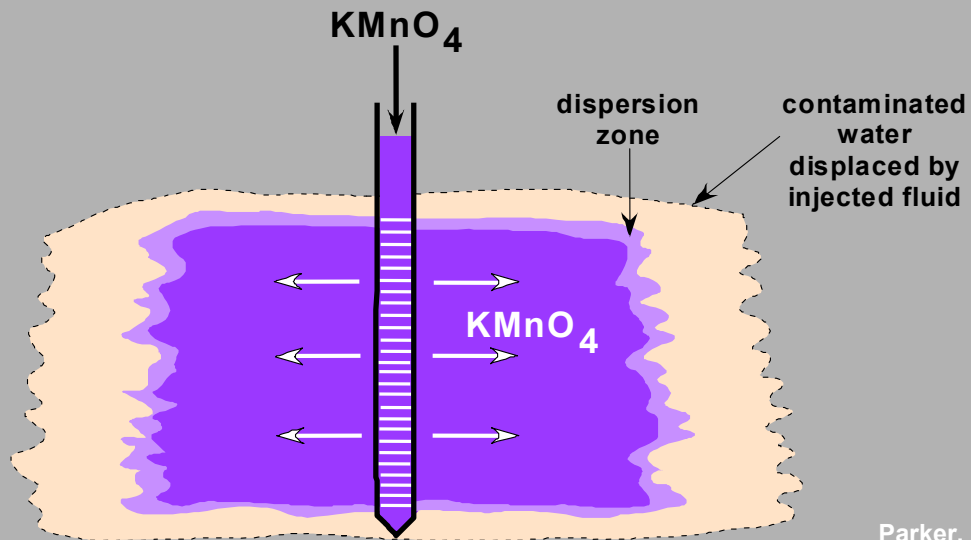

16

Parker, 1997

Injection of Discs Leaving Gaps Minimizes Displacement of Contaminated Water

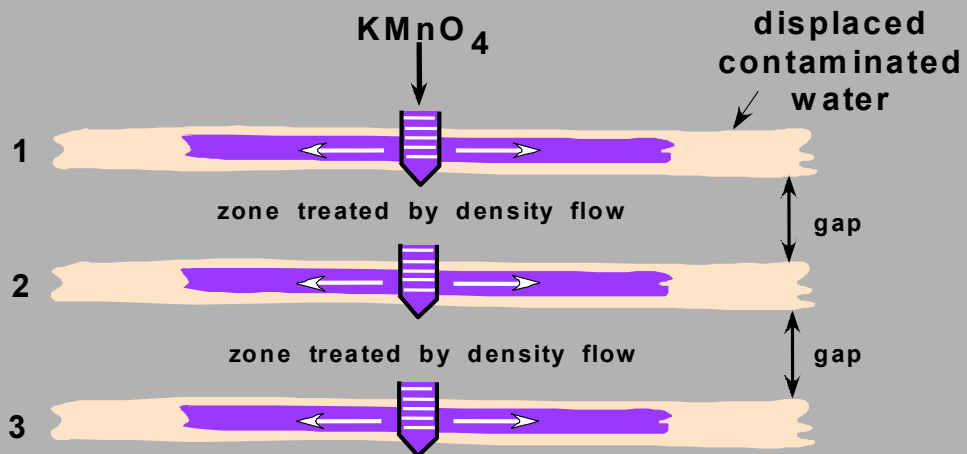

17

Parker, 1997

Injection of Multiple Discs Using Direct Push Device

Stage 1

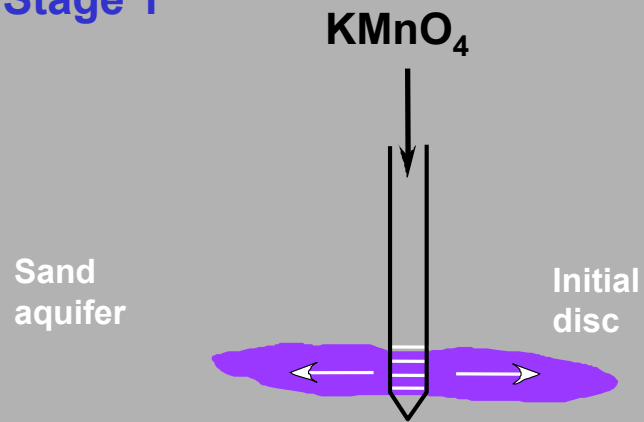

18

Parker, 1997

Injection of Multiple Discs Using Direct Push Device

Stage 2

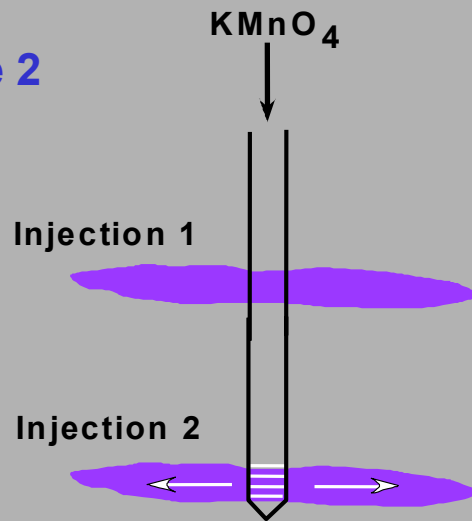

19

Parker, 1997

Stage 1: Inject Disc Above DNAPL on Aquitard

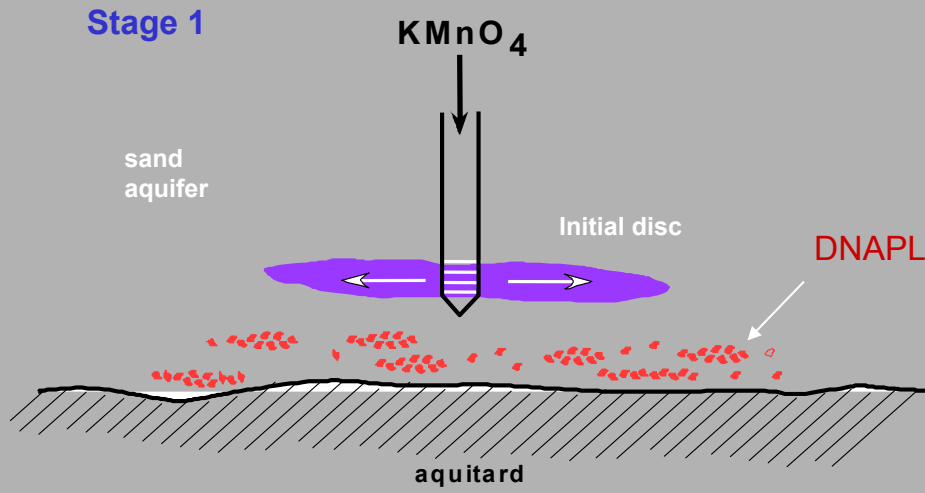

20

Parker, 1997

Disc Sinks and Spreads

Injector withdrawn

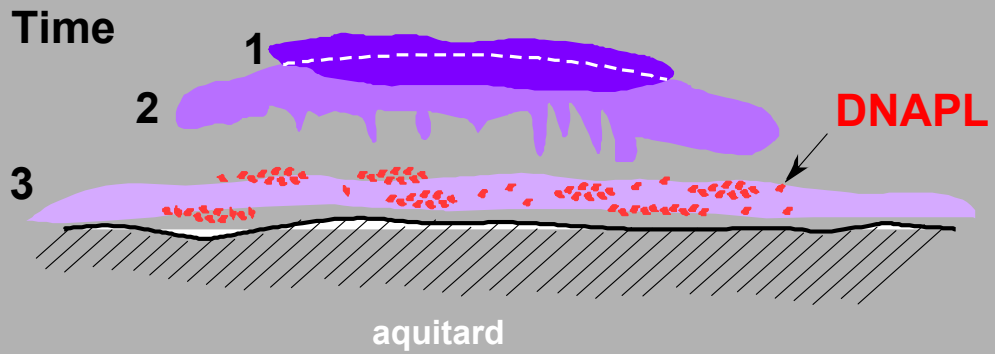

21

Parker, 1997

Case Study in Florida



TCE and TCA
source zone

Site

22



Ft. Lauderdale Site



23

Picture 0564

Contamination Occurred Recently late 1996 to early 1997

- TCA used: 1995-96
- Switch from TCA to TCE: Nov 1996 - April 1997
- Conventional monitoring wells installed: 1997
- Fenton's treatment pilot study: 1998-1999
- UW bundle multi-levels installed: 1999
 - Fenton's performance assessment
- Permanganate selected as source removal action for permanent remedy

24



Site Geology

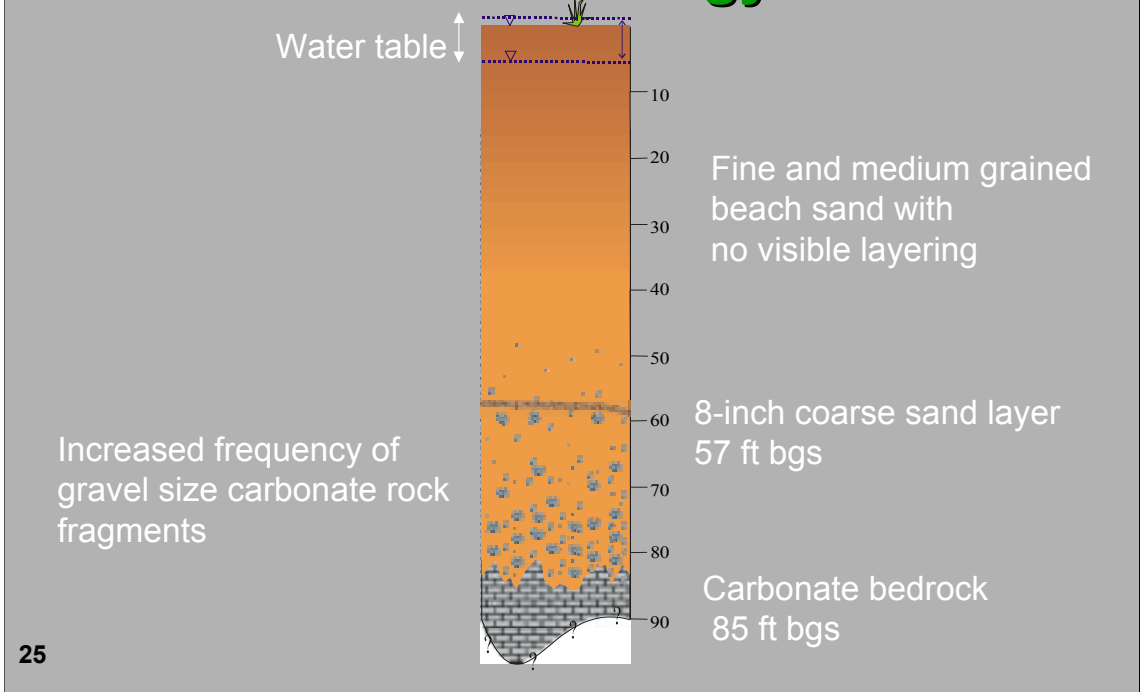

Monitoring Methods

Focus on depth-discrete methods

- Continuous Cores
- Bundle tube samplers
- Waterloo Profiler
- Conventional Monitoring Wells
- Micro-monitoring Wells

Core Being Removed from Piston Core Barrel

Aluminum core tube
inside core barrel



27

Cutting the Aluminum Core Tube



28

Subsampling Sand for VOC Analysis



29

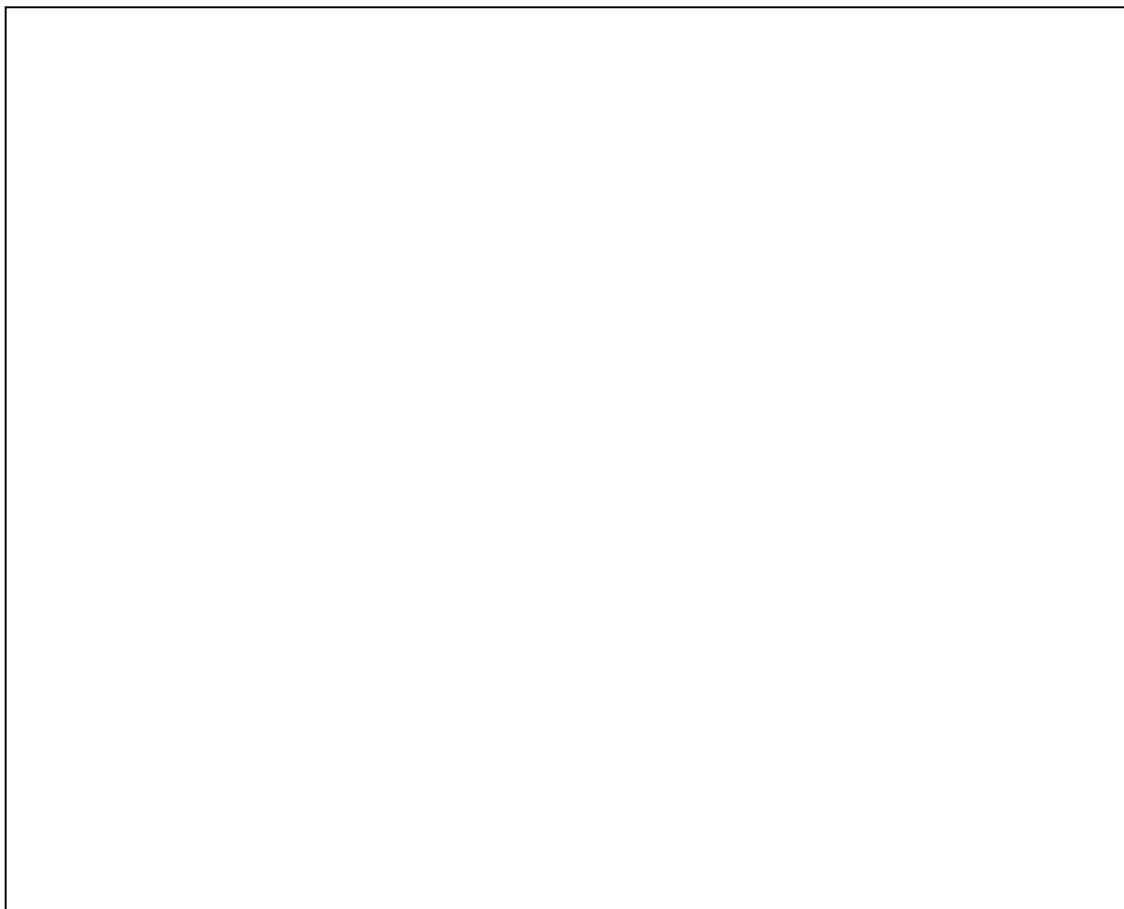

Installation of Bundle Tube Sampler: 1999



30



Bundle Tube Sampler

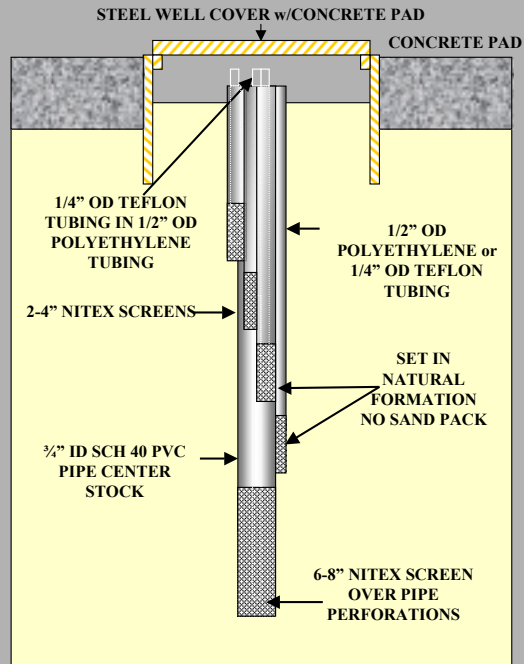

31

TCE Concentration Profile CW-L

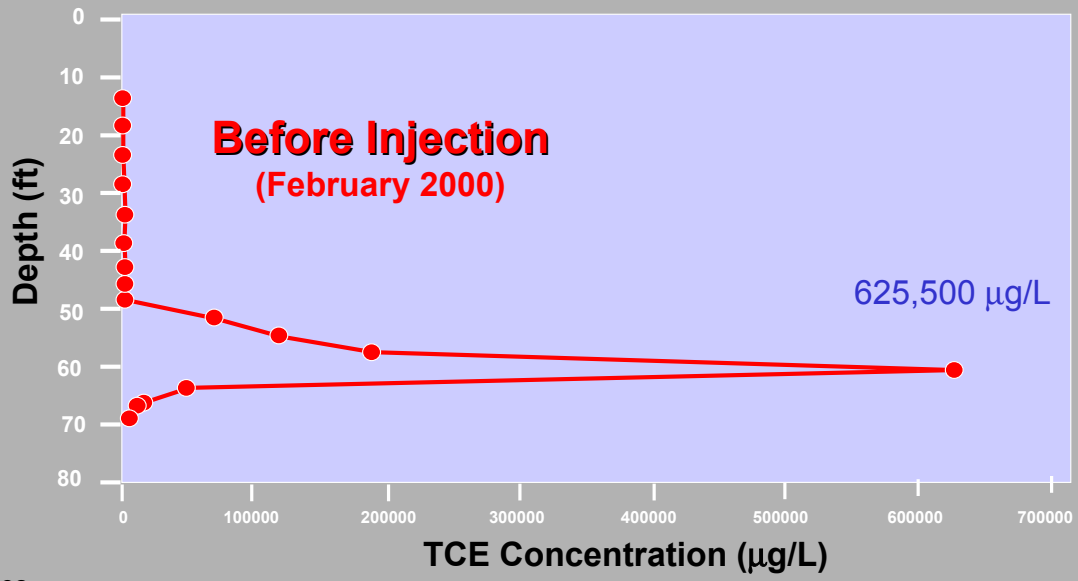

32



TCE Concentration Profile CW-K

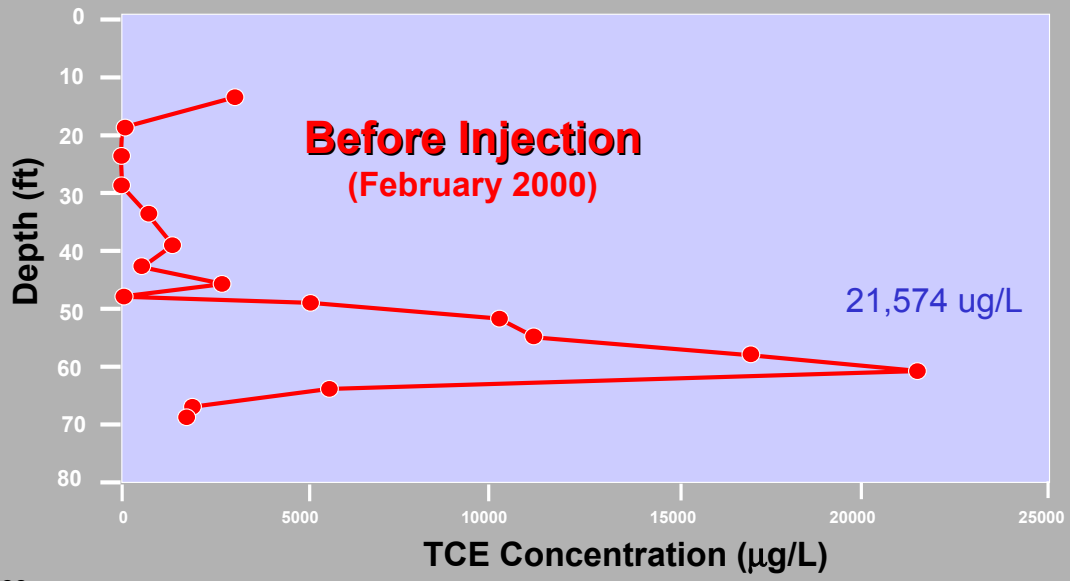

33



Conceptual Model of DNAPL Distribution

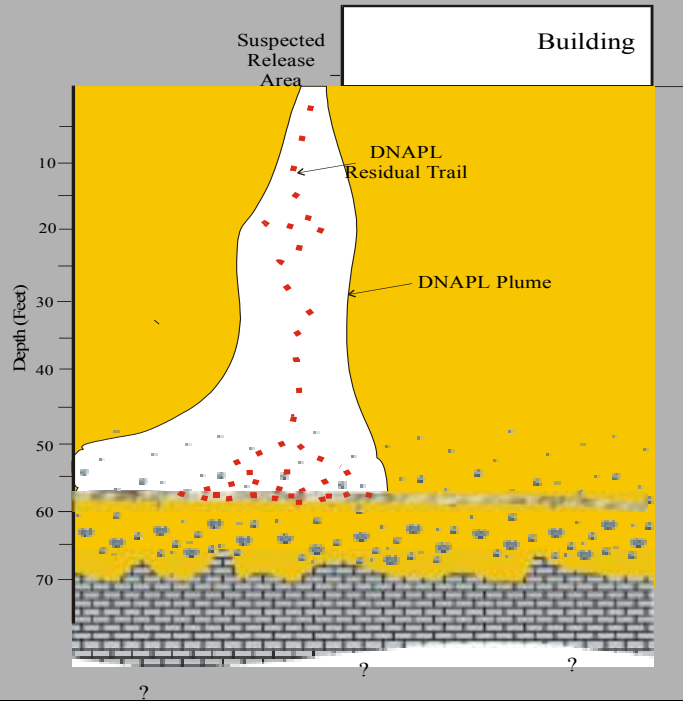

Before Remediation

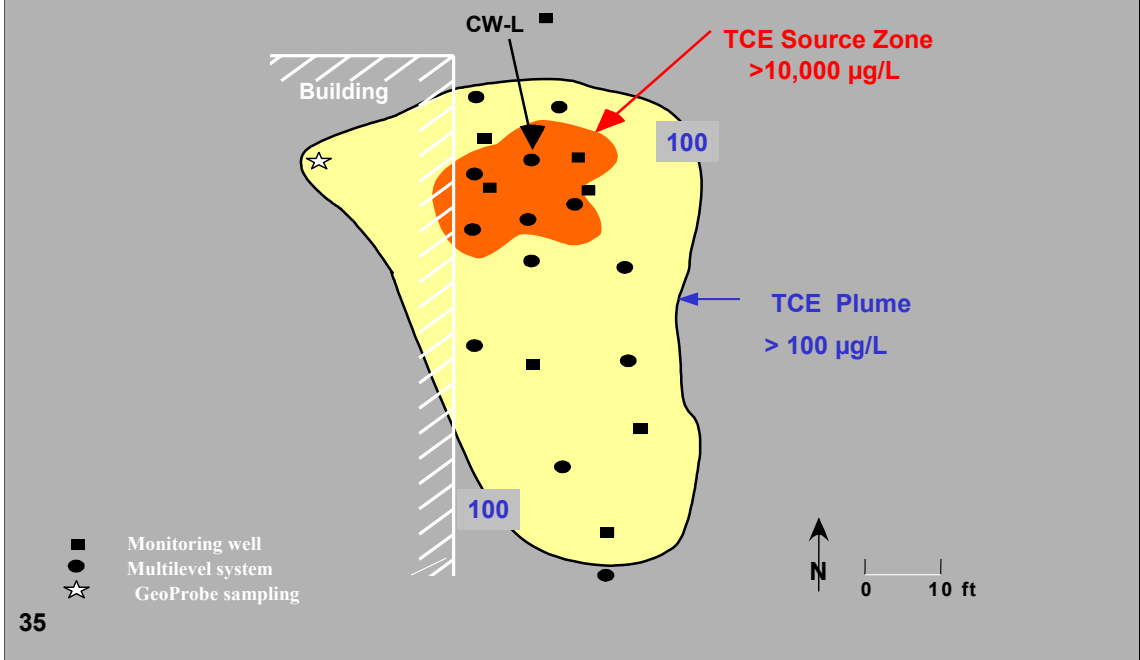

The Waterloo Passive Approach for Permanganate

1. Pre-injection delineation
2. Permanganate injection in targeted zones
3. Monitor results and design subsequent injection
4. Repeat steps until attain desired endpoint

36



Full-Scale Permanganate Remediation in Ft. Lauderdale, FL



KMnO₄ Mixing Tank



38

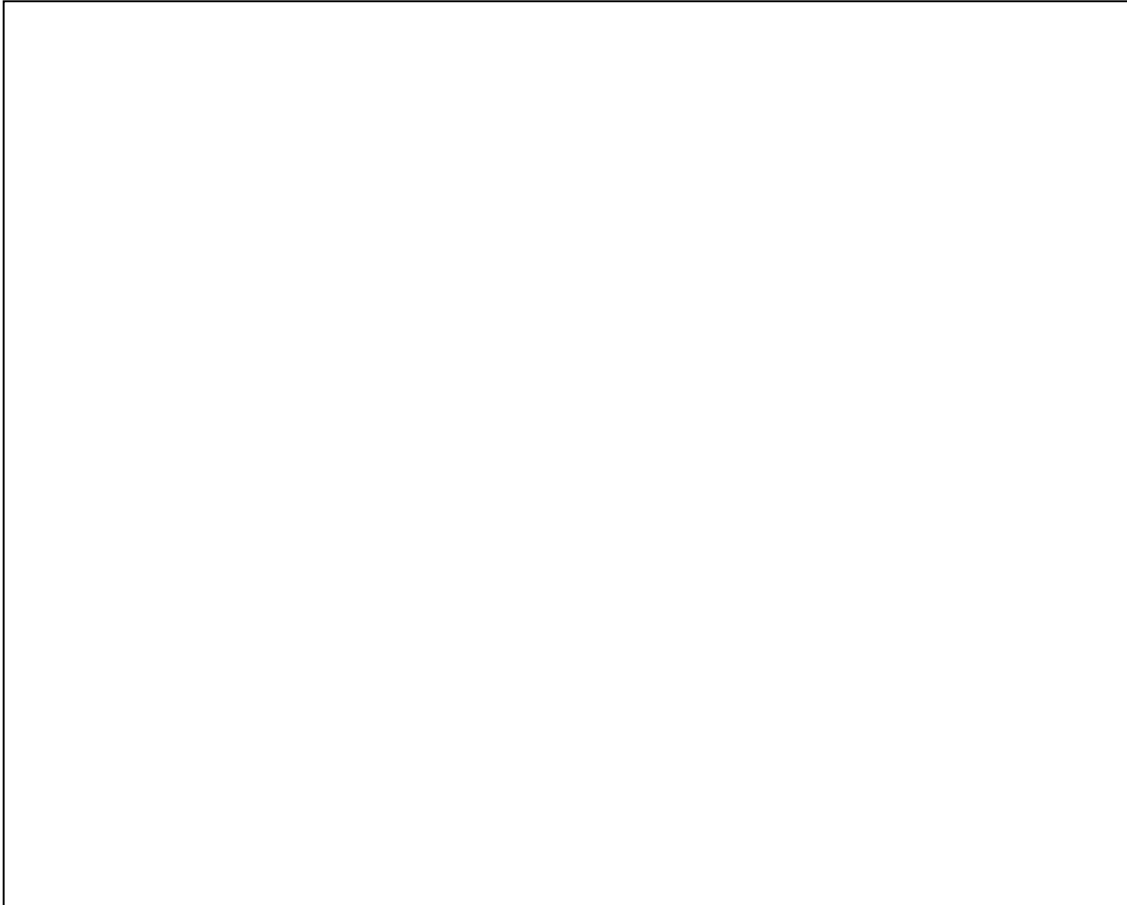

39



Stage 1: KMnO_4 Injection at Several Depths

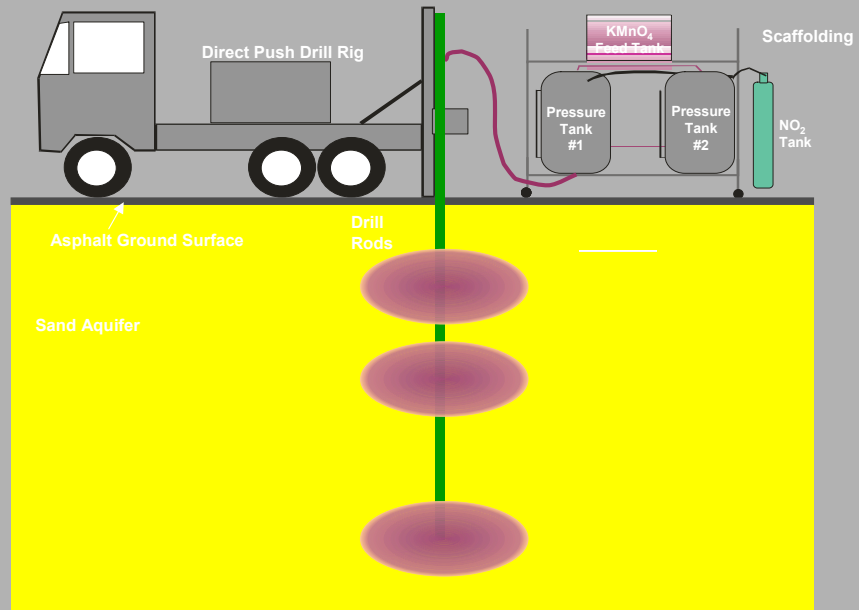

40

Parker, 2000

Stage 2: Spreading and Sinking by Density

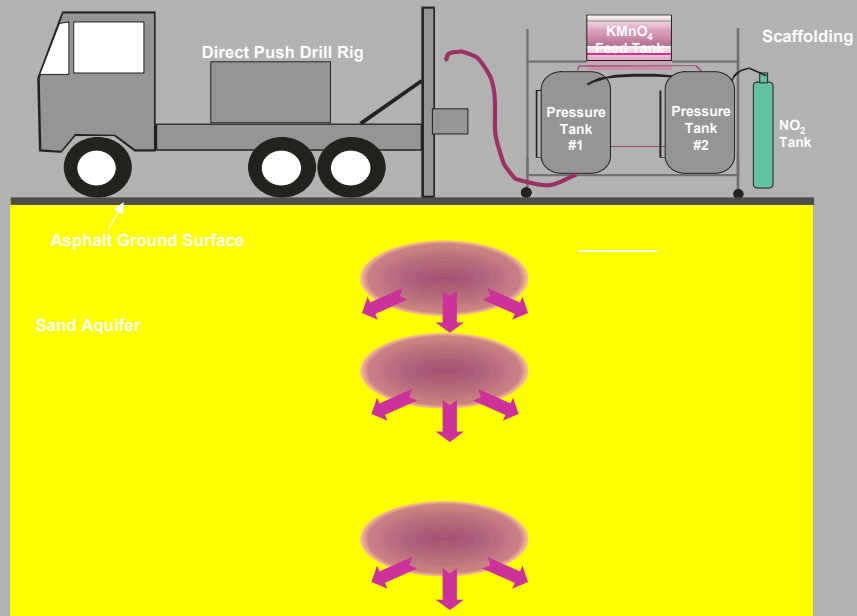

41

Parker, 2000

Conceptual Model of DNAPL Distribution

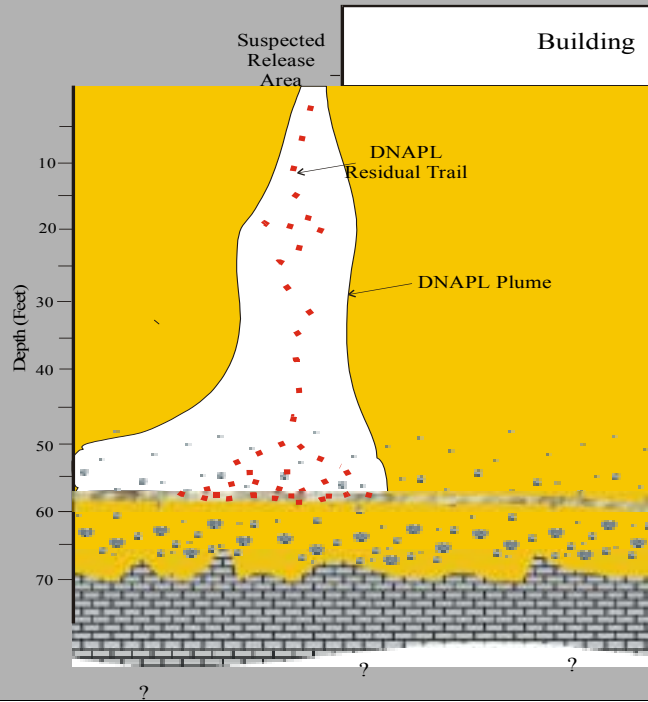

42

Parker, 2000

KMnO₄ Target Treatment Zone

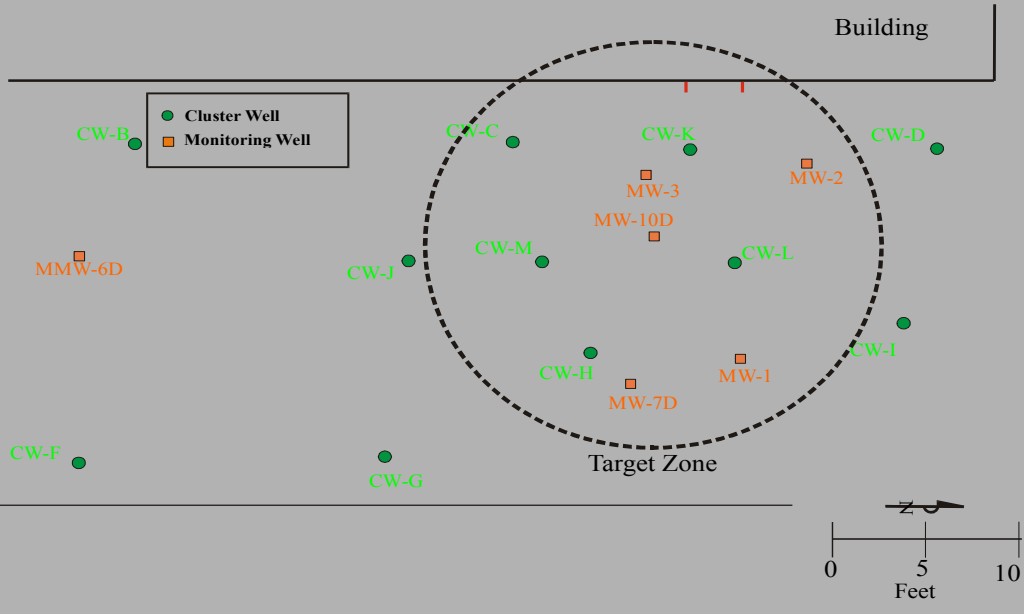

43



Source Zone Wells



44

Picture 0569

KMnO₄ Injection Coverage Episode 1

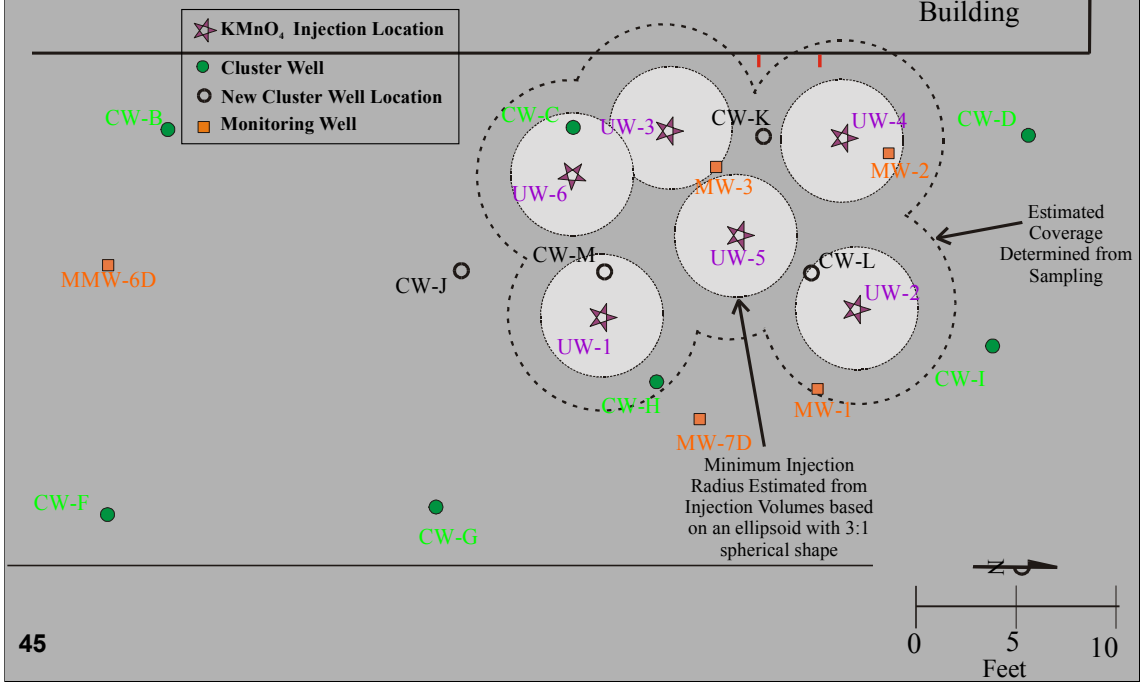

KMnO₄ Injection at Multiple Depths

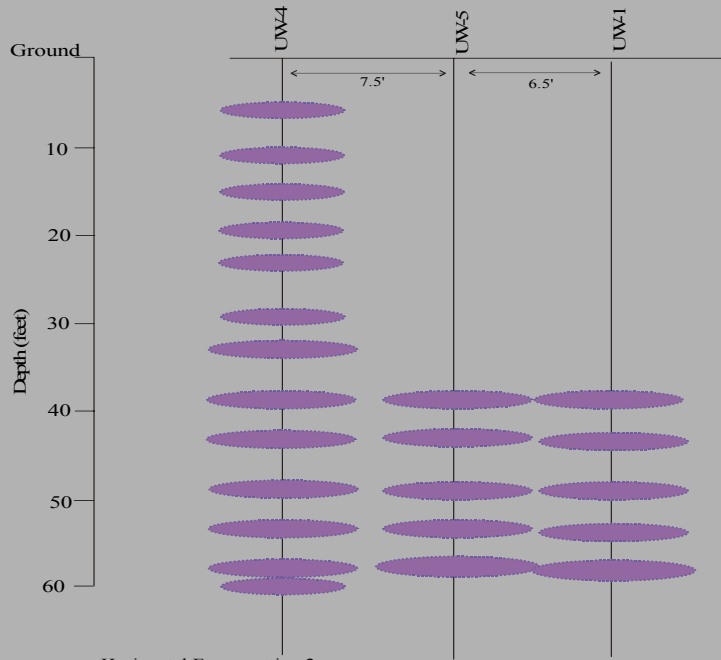

46

Horizontal Exaggeration 2x
Ellipsoid size based on 30% porosity and a height to width ratio of 3:1.



Effects of Density and Diffusion on Injected KMnO_4 Ellipsoids

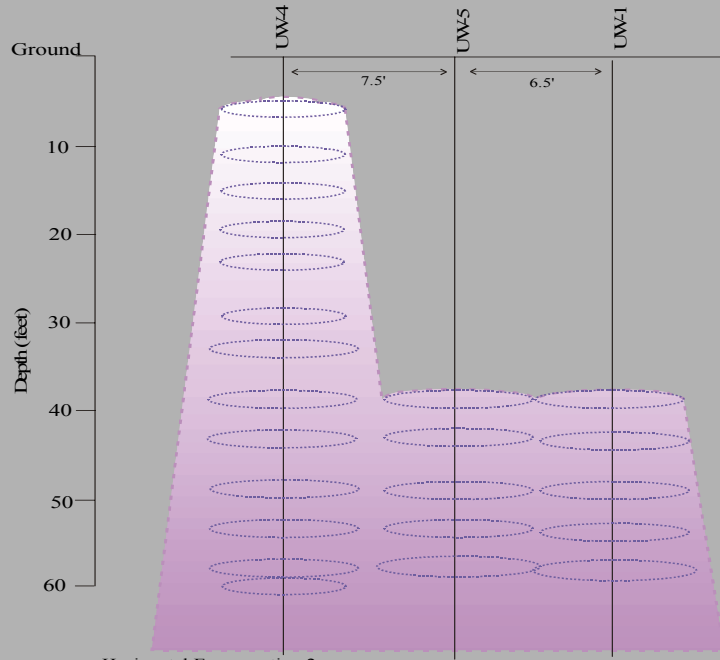

48

Horizontal Exaggeration 2x
Ellipsoid size based on 30% porosity and a height to width ratio of 3:1.

Project Timeline

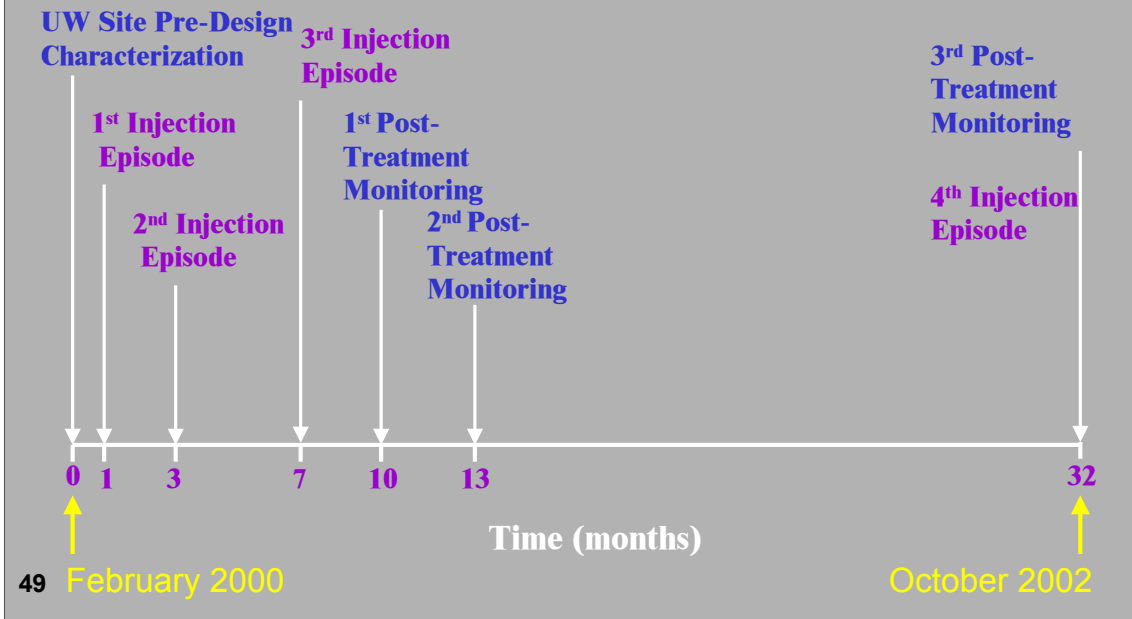

Site Map – X Sections

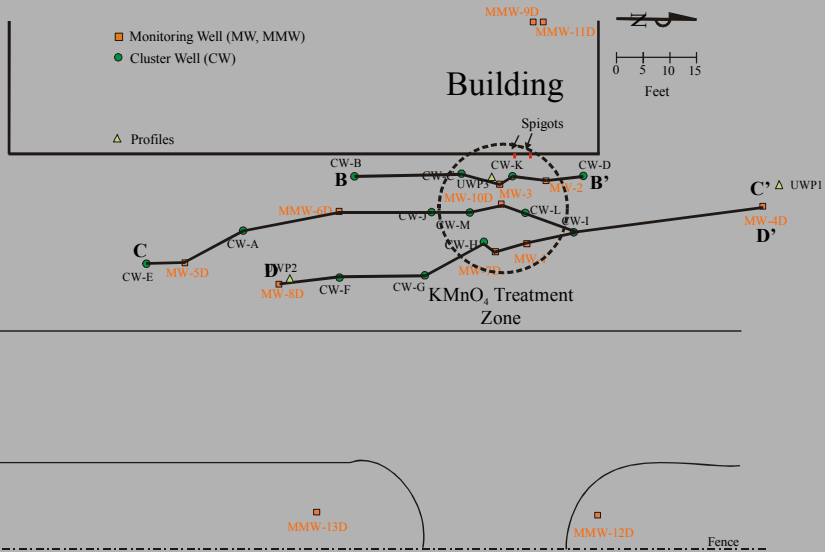

50

TCE Distribution on B-B' – Feb 2000

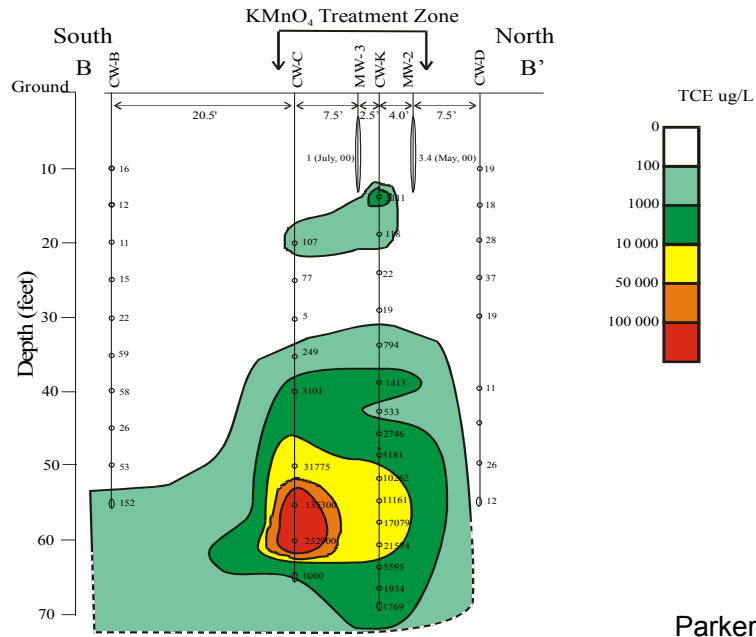

51

Parker et al., 2000

TCE Concentration Profile CW-K

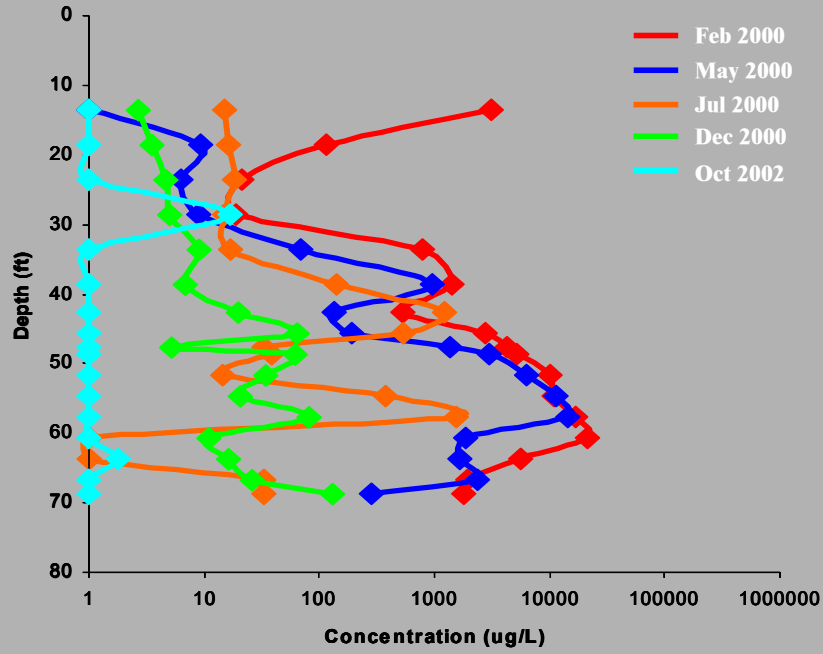

53



TCE Concentration Profile CW-K Prior to 4th Injection

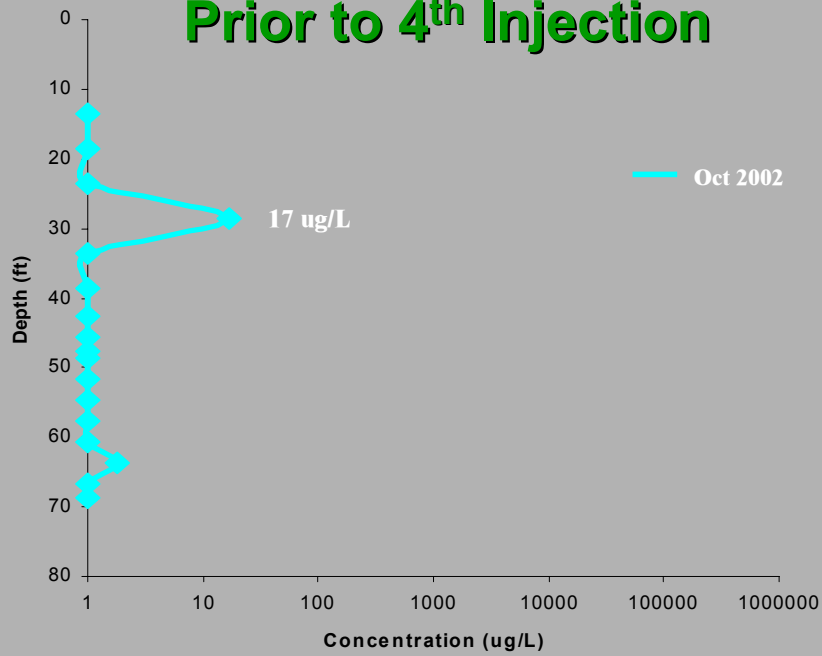

54

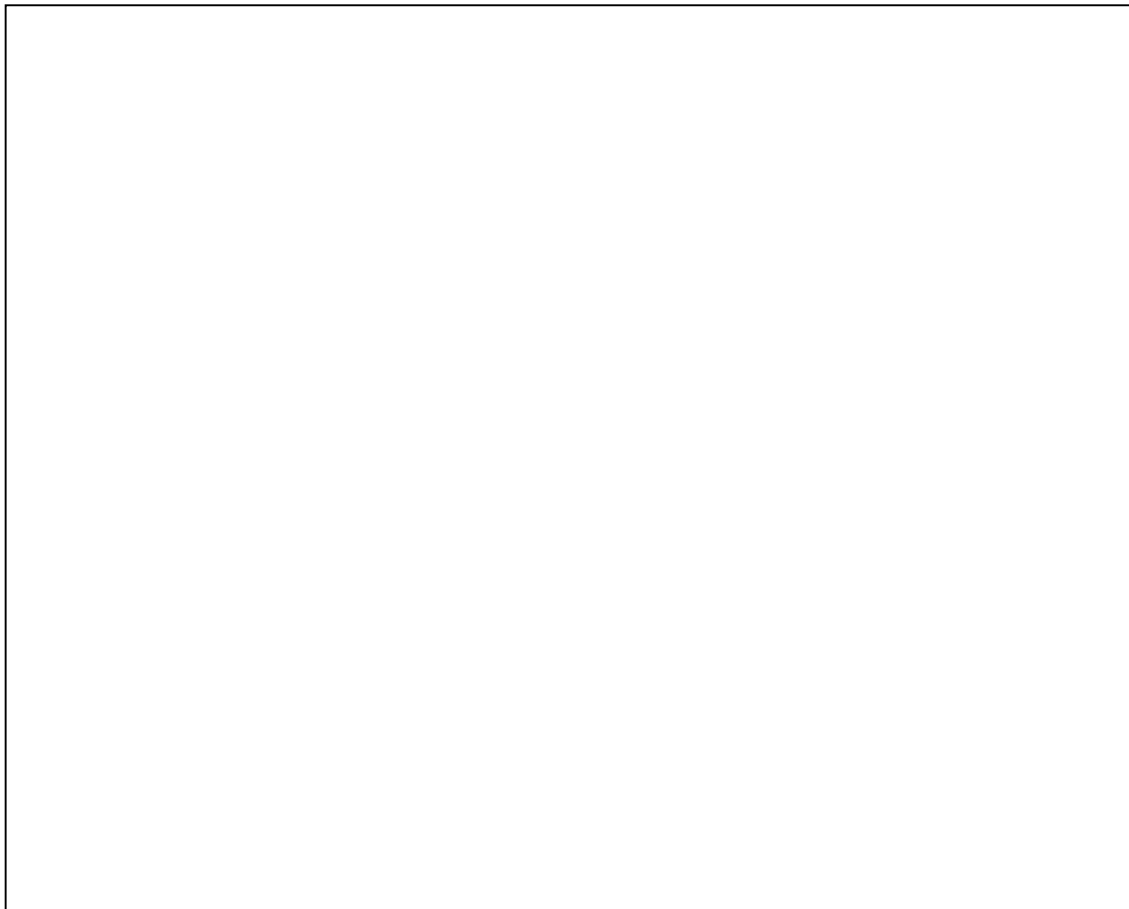

TCE Distribution on C-C' – Feb 2000

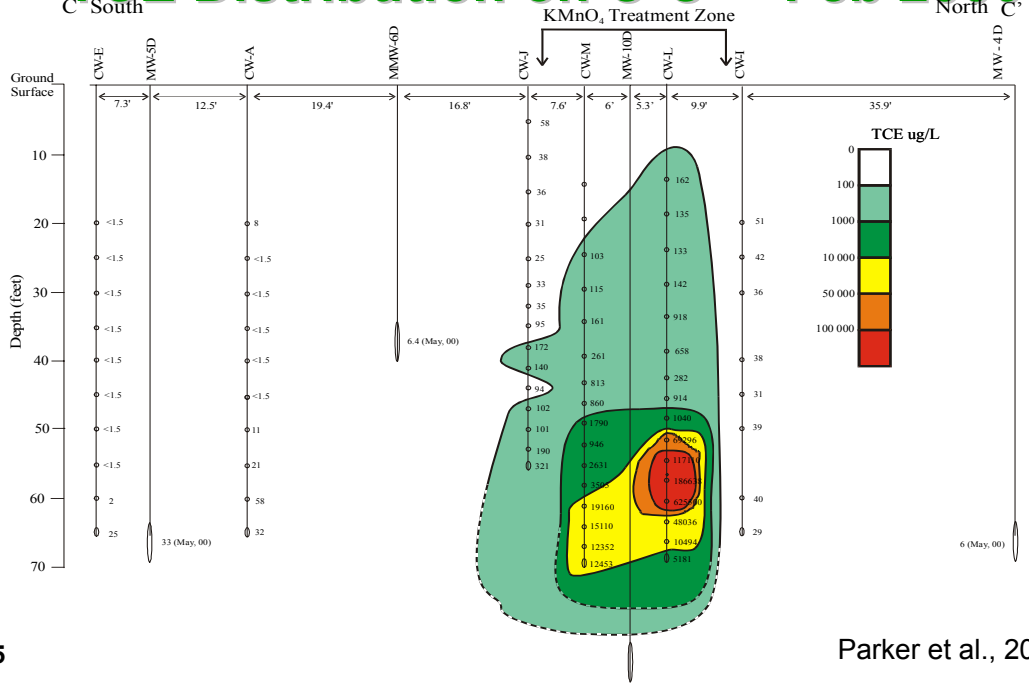

55

Parker et al., 2000

TCE Distribution on C-C' – Oct 2002

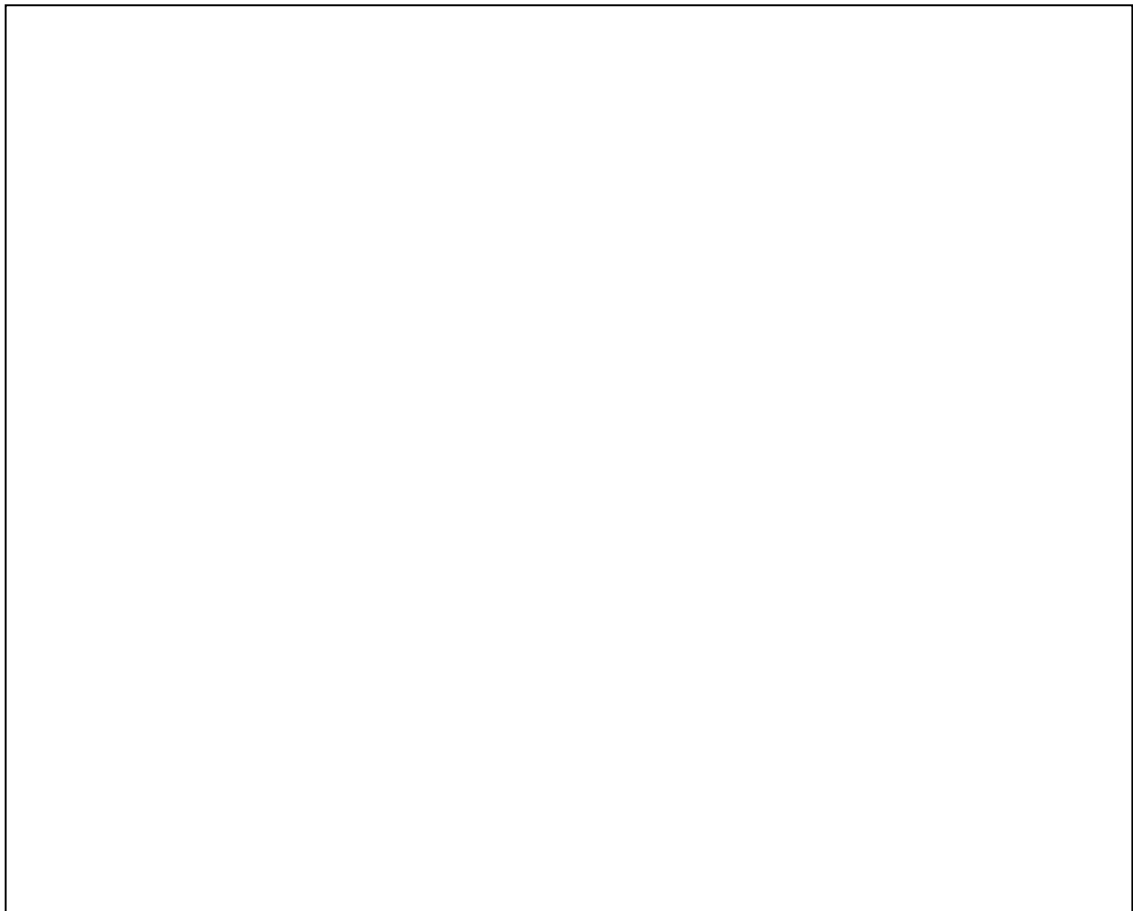
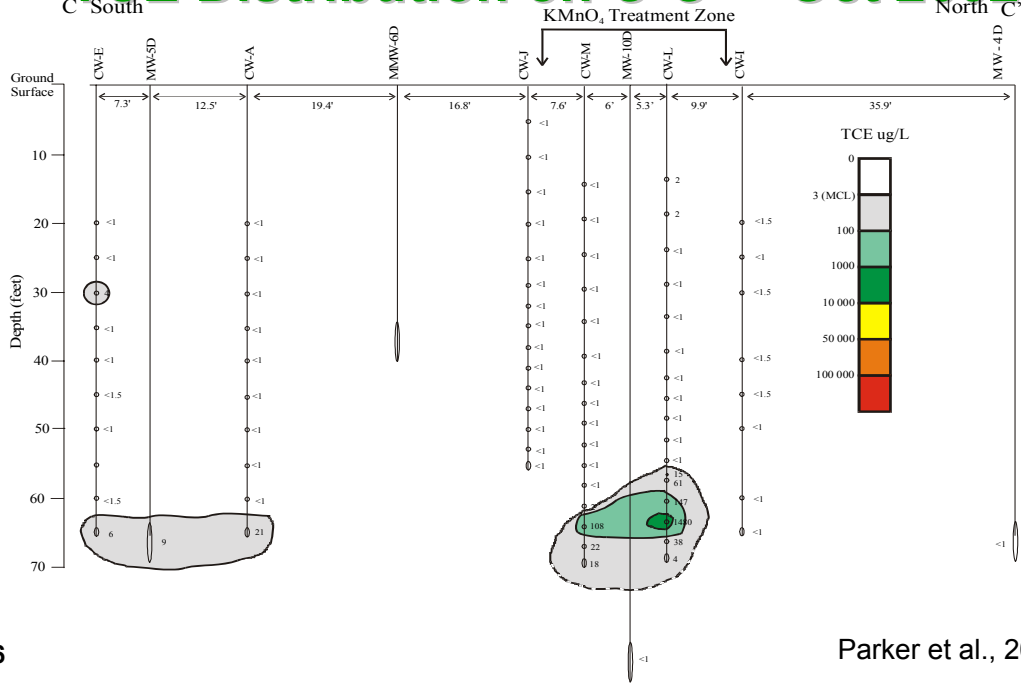

TCE Concentration Profile CW-L

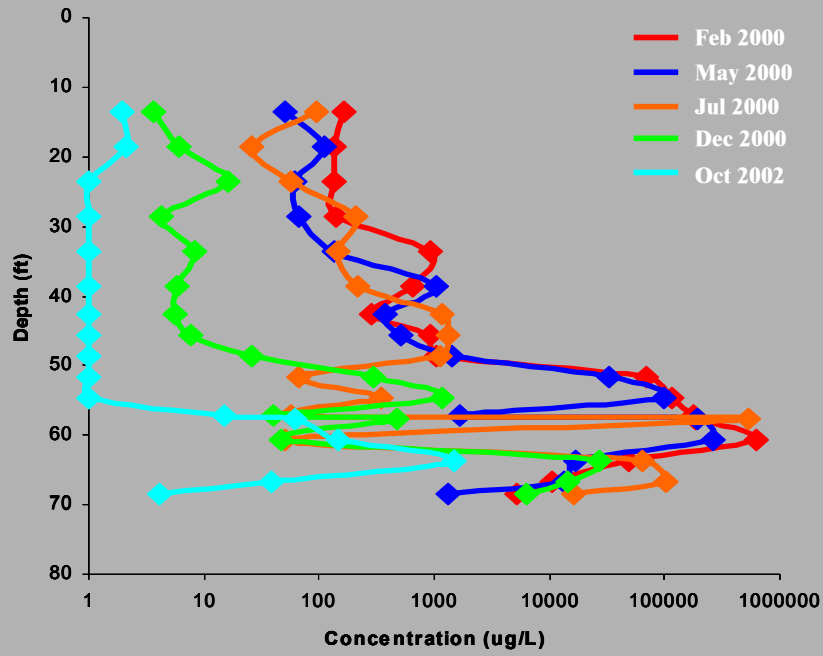

57



TCE Concentration Profile CW-L Prior to 4th Injection

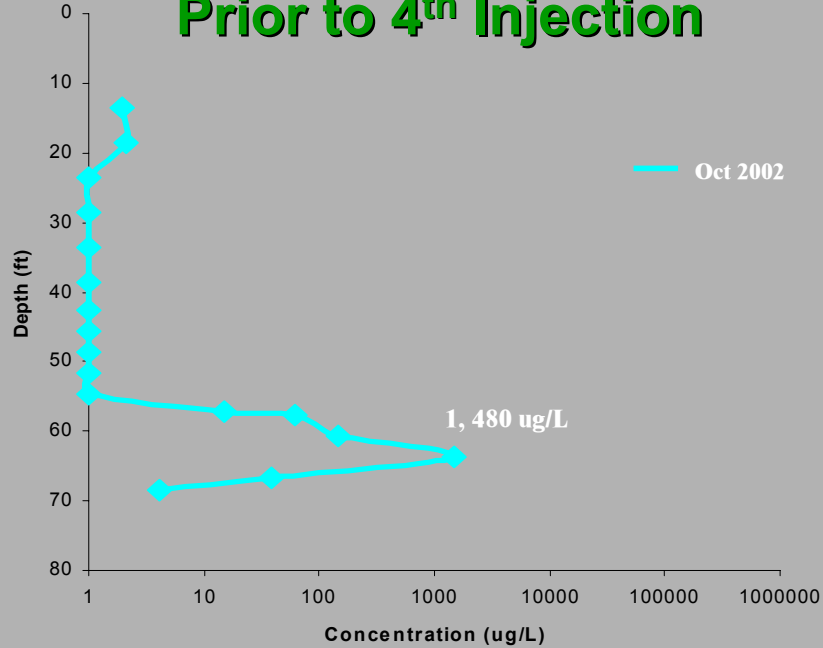

58

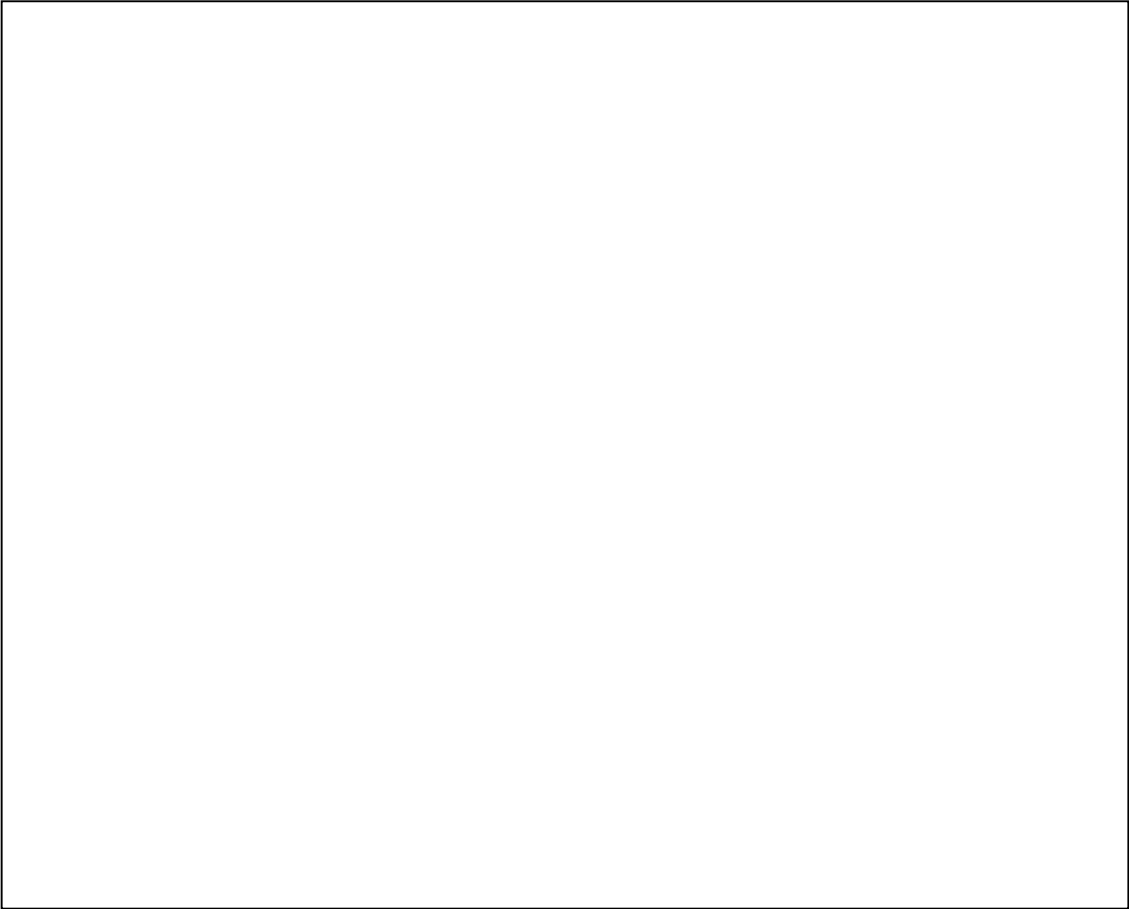

TCE Distribution on D-D' – Feb 2000

South D

D' North

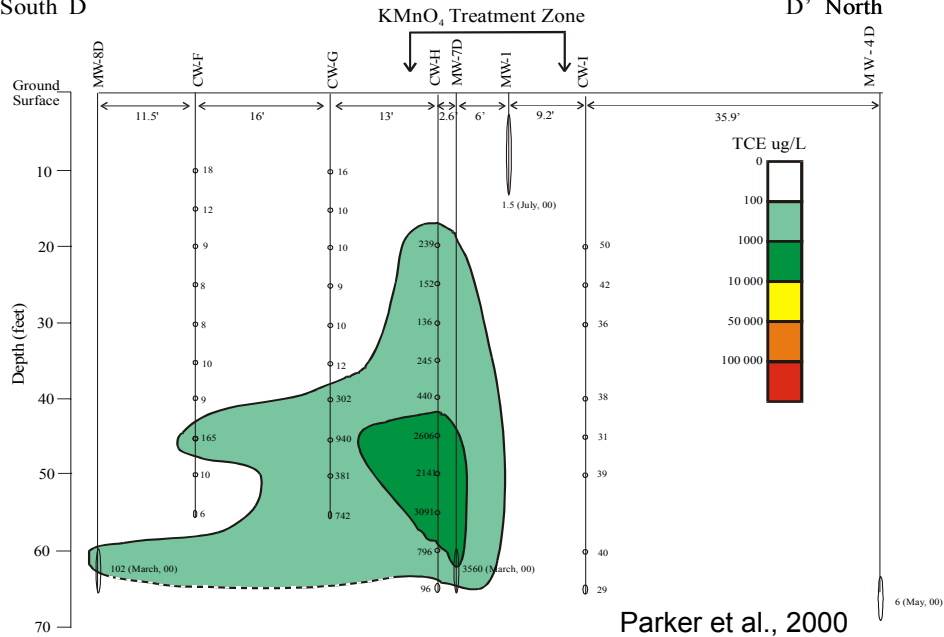

59

Parker et al., 2000

TCE Distribution on D-D' – Oct 2002

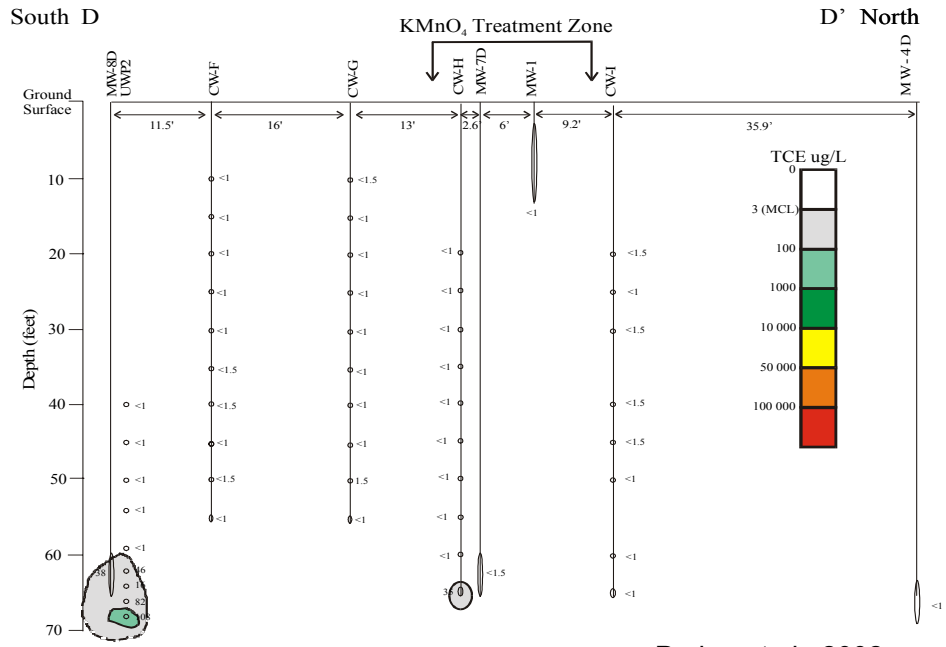

Parker et al., 2002

TCA Distribution on C-C' – Feb 2000

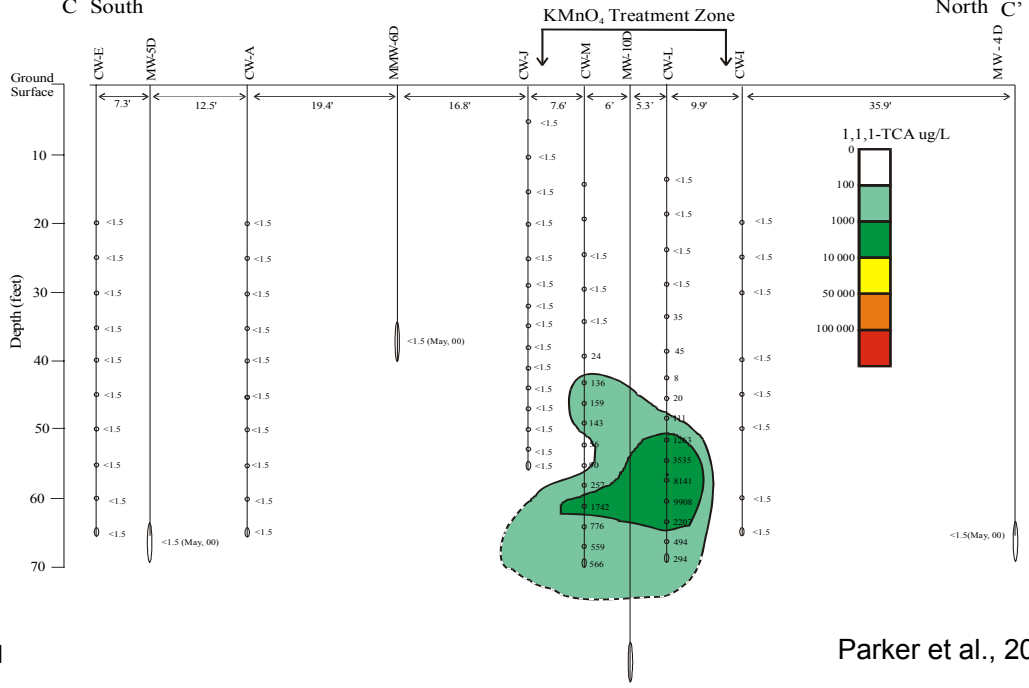

61

Parker et al., 2000



TCA Distribution on C-C' – Oct 2002

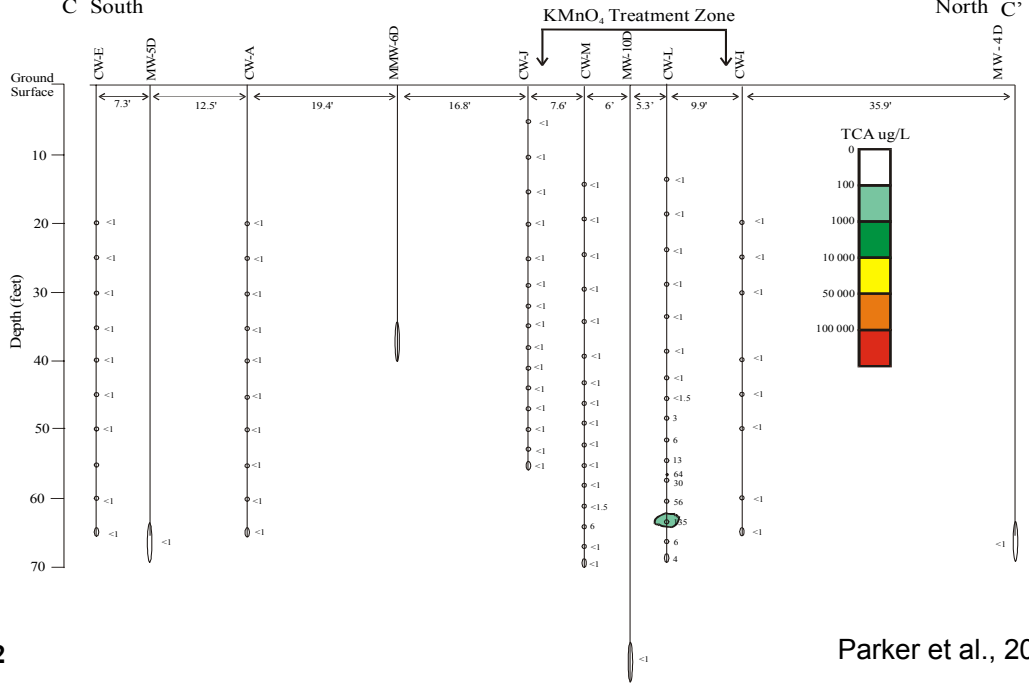

Before Remediation – February 2000

TCE $\mu\text{g/L}$

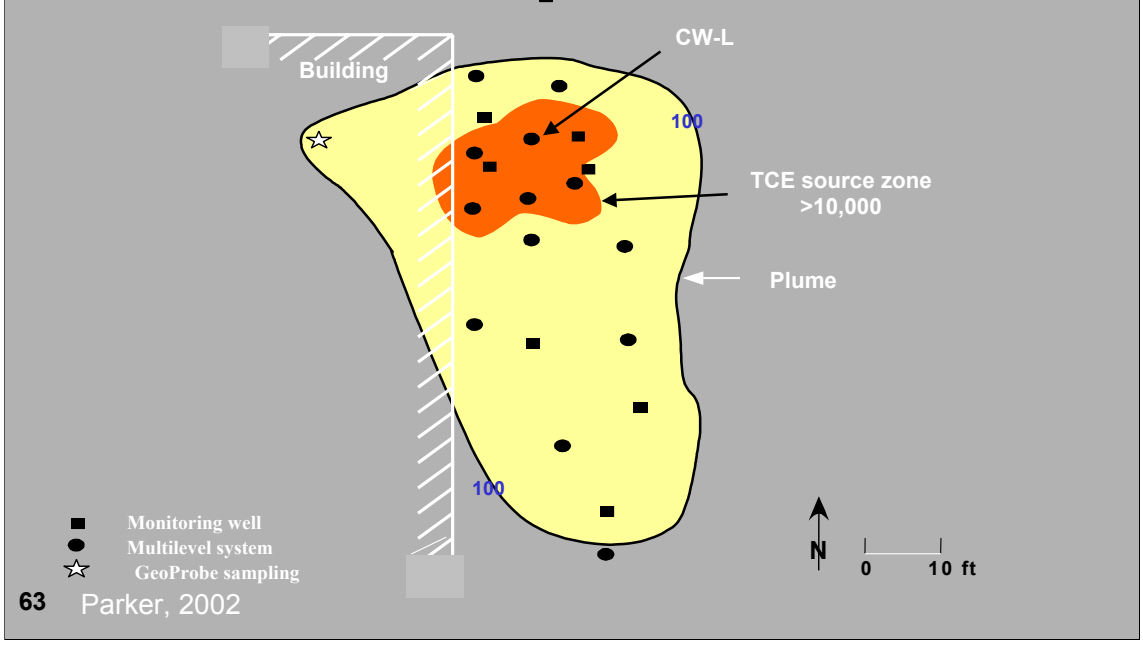

After Remediation – December 2000

TCE $\mu\text{g/L}$

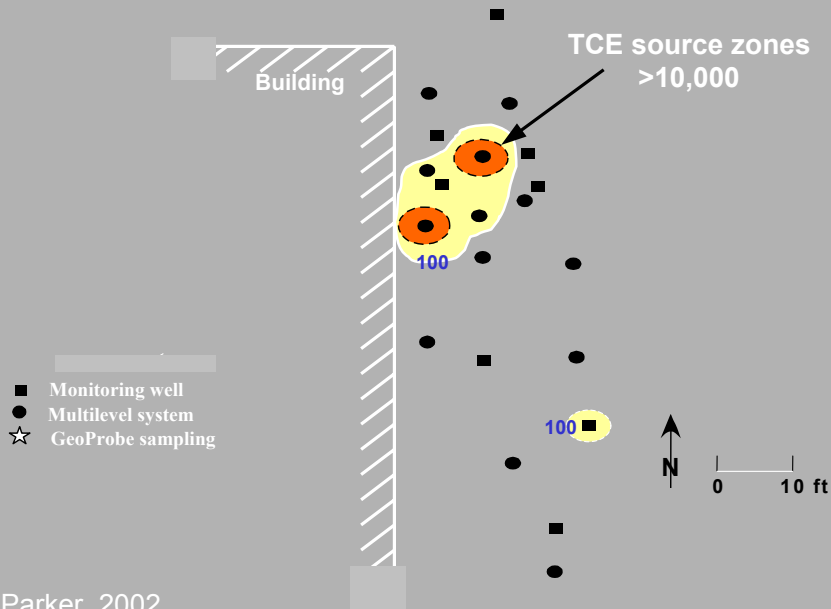

64 Parker, 2002

After Remediation – October 2002

TCE $\mu\text{g/L}$

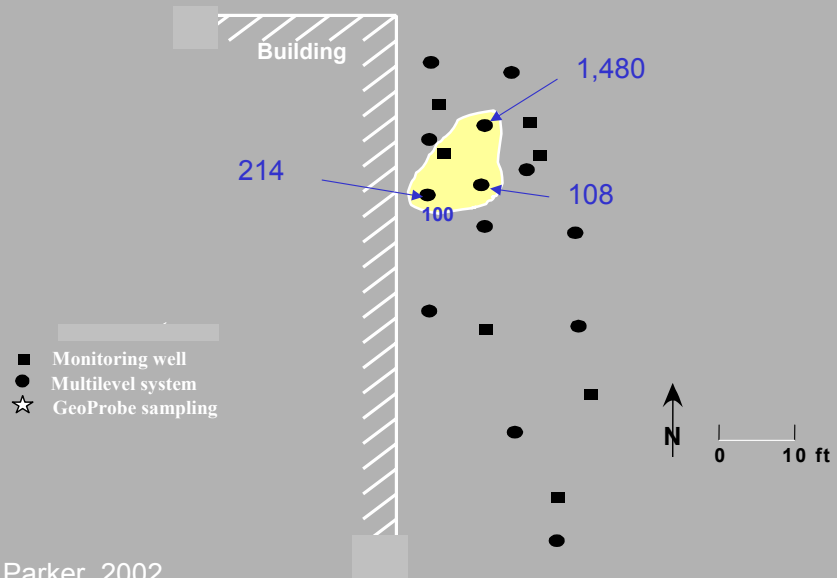

65 Parker, 2002

Specific Conclusions

- 99% reduction in contaminated volume
- Displacement avoided by limiting injection to <8% of treatment zone pore volume for each episode
- 1,1,1-TCA also disappeared
- No TCE or TCA rebound

66



General Conclusion

This case study showed that permanganate can be successful for ***complete remediation*** of the source ***if*** :

- The site conditions are suitable
- The remedial design is tailored to the site

Final Stage

- **Fourth injection occurred October 2002 to complete source zone remediation**
- **Performance assessment monitoring planned for February 2003**

68



Acknowledgements

Funding:

- University Consortium Solvents-in-Groundwater Research Program
- Canadian Natural Sciences and Engineering Research Council
- Sun Belt Interplex, Inc.

Staff:

- Matthew Nelson, MSc Hydrogeologist: Project Manager
- Colin Meldrum, BAsC: Field Activities and Data Display
- Bob Ingleton, Paul Johnson, BSc: Injection System Design and Field Technical Assistance
- Martin Guilbeault, MSc, Matthew Whitney, BAsC: Field Assistance
- Maria Gorecka, MSc: Lab Analysis of VOC



For information on this case study:

Parker, B.L., J. A. Cherry and T. A. Al (2002).

Passive permanganate remediation of a solvent DNAPL source zone.

In proceedings for “The Third International Conference on Remediation of Chlorinated and Recalcitrant Compounds,” Monterey, California.

[Battelle 2002 Monterey Conference Proceedings](#)

